



LB1500R
LB1500RTC
LB1503R
Open-Frame Monitors

USER'S GUIDE

www.planar.com

The information contained in this document is subject to change without notice.
This document contains proprietary information that is protected by copyright. All rights are reserved. No part of this document may be reproduced, translated to another language or stored in a retrieval system, or transmitted by any means, electronic, mechanical, photocopying, recording, or otherwise, without prior written permission. Windows is a registered trademark of Microsoft, Inc.
Other brand or product names are trademarks of their respective holders.

European Union 2002/95/EC Directive on the Restriction of Hazardous Substances (RoHS)

In February 2003, the European Union issued Directive 2002/95/EC on the Restriction of Hazardous Substances, commonly known as RoHS, in certain electrical and electronic equipment. It restricts the use of six hazardous substances, including lead (Pb).

The Directive states that all products placed on the European market after July 1, 2006 must be compliant with its requirements.

Planar Systems Inc. is fully in support of and compliant with EU Directive 2002/95/EC on all its products, except where exempted, such as medical. Should those exemptions be removed in the future, Planar will comply with such Directives or amendments.

A Planar part number will be modified with an "LF" suffix designation to indicate RoHS compliance, as shown on the part number label affixed to the display and on the box containing the display.

Important Recycle Instructions:

 LCD Lamp(s) inside this product contain mercury. This product may contain other electronic waste that can be hazardous if not disposed of properly. Recycle or dispose in accordance with local, state, or federal Laws. For more information,

contact the Electronic Industries Alliance at WWW.EIAE.ORG. For lamp specific disposal information check WWW.LAMPRECYCLE.ORG.

Revision Control

Date	Description
May 2006	Document number 020-0463-00A
March 2007	Document number 020-0463-01A Inserted LB1500RTC information

Contents

Usage Notice

Precautions	2
-------------------	---

Introduction

About the Products	3
--------------------------	---

Package Overview	5
------------------------	---

Installation

Product Overview	6
------------------------	---

Signal Input Layout	6
---------------------------	---

Start Your Installation	7
-------------------------------	---

User Controls

Rear Panel Controls	8
---------------------------	---

How to Use the OSD Menus	10
--------------------------------	----

On-Screen Display Menus.....	11
------------------------------	----

Appendices

Troubleshooting.....	13
----------------------	----

Warning Signal.....	14
---------------------	----

Product Dimensions	14
--------------------------	----

Compatibility Modes	18
---------------------------	----

Usage Notice



Warning- To prevent the risk of fire or shock hazards, do not expose this product to rain or moisture.



Warning- Please do not open or disassemble the product as this may cause electric shock.

Precautions

Follow all warnings, precautions and maintenance as recommended in this user's manual to maximize the life of your unit.

Do:

- *Turn off the product before cleaning.*
- *LCD front surface may be cleaned using a soft clean cloth moistened with mild window glass commercial cleaners or 50/50 mixture of water and isopropyl alcohol.*
- *Use only high quality safety approved AC/DC power adapter that comes with your monitor.*
- *Disconnect the power plug from the AC outlet if the product is not going to be used for an extended period of time.*

Don't:

- *Do not touch the LCD Display screen surface with sharp or hard objects.*
- *Do not use abrasive cleaners, waxes or solvents for cleaning.*
- *Do not operate the product under the following conditions:*
 - *Extremely hot, cold or humid environment.*
 - *Areas susceptible to excessive dust and dirt.*
 - *Near any appliance generating a strong magnetic field.*
 - *In direct sunlight.*

Introduction

About Planar's LB1500R/LB1500RTC/LB1503R

The LB1500R/LB1500RTC/LB1503R is a 15" flat panel screen with an active matrix, thin-film transistor (TFT) liquid crystal display (LCD).

Features include:

- Direct analog signal input
- Direct digital DVI signal input (LB1503R)
- Direct composite video signal input (LB1503R)
- Active matrix TFT LCD technology
- 1024x768 XGA resolution
- 15" viewable display area
- 31.5 ~ 60 kHz horizontal scan
- 56 ~ 75 Hz refresh rate
- Auto -adjustment function
- Multilingual OSD user controls
- VESA DPMS power saving
- 75 mm VESA rear mount attachment

Touch Screen for LB1500RTC

Capacitive for finger interface

- Surface: Anti-glare treatment
- Interface: USB
- Durability: 225 million touches in a single location
- Hardness: Cannot be scratched using any stylus with Mohr's rating of less than 6.5
- Transmissivity: up to 91.5% at 550 nm
- Driver: Microsoft® Windows® 2000/XP/CE/XP Embedded/Server™ 2003/Linux

Package Overview



LB1500R/LB1500RTC
Monitor



LB1503R Monitor

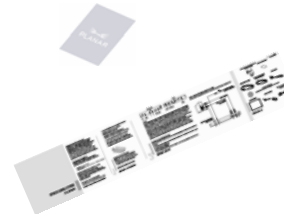

Quick Start Guide

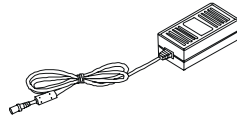

Power Adapter

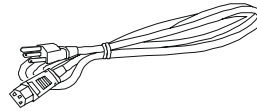

Power Cord

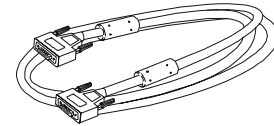

VGA Signal Cable



DVI-D Cable
For LB1503R



Video BNC Cable
For LB1503R

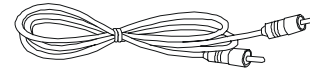

USB Cable
For LB1503R



Touchscreen Driver
Installation CD-ROM

Installation

Product Overview

Front View

LB1500R/LB1500RTC



Front View

LB1503R

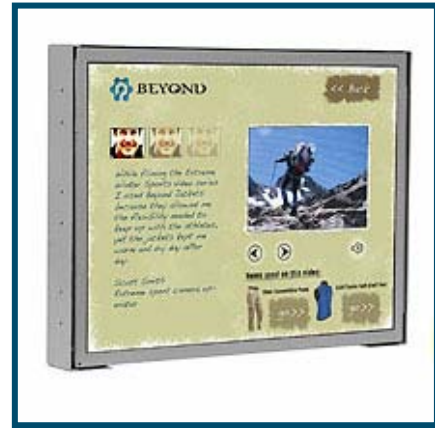

Signal Input Layout

Figure 1. LB1503R Connector Inputs

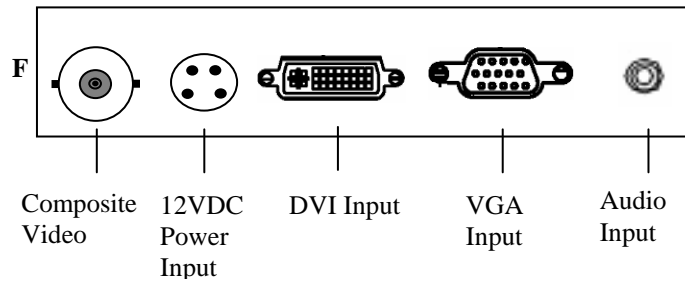
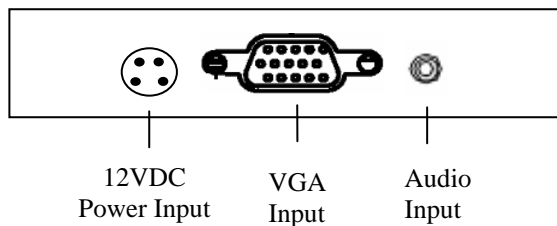
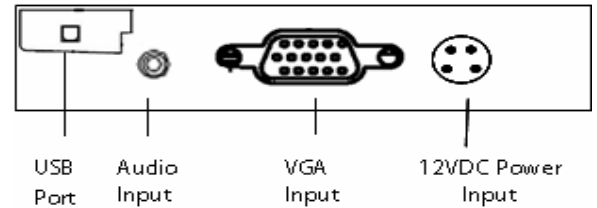

Figure 2. LB1500R/LB1500RTC Connector Inputs

LB1500R



LB1500RTC



Start Your Installation

Connecting the Display (Figure 3)

To setup this display, please refer to the following figure and procedures.

1. Be sure all equipment is turned off.
2. Connect the DC power cord to the power connector; plug one end of the AC power cord into the power adapter, and the other end into an electrical outlet (❶).
3. Connect the VGA signal cable from display VGA input connector to the 15-pin connector of your host computer and tighten the screws (❷).
4. For LB1503R connect the DVI signal cable from display DVI input connector to DVI connector of your host computer and tighten the screws (❸).
5. For LB1503R connect the composite video cable from display video input to video output source (❹).
6. **For LB1500RTC do not connect the USB cable until touchscreen software driver is installed! (❺)**
7. Turn on your computer, display and or video source.

Figure 3. The LB1500R Connections

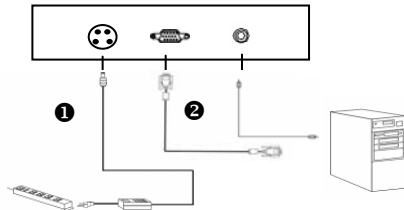

Figure 3. The LB1500RTC Connections

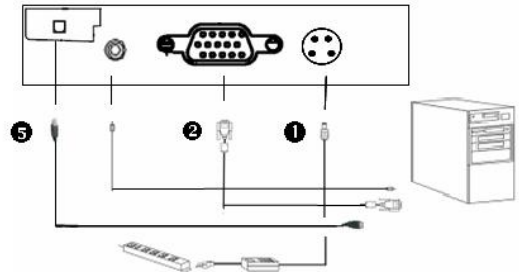
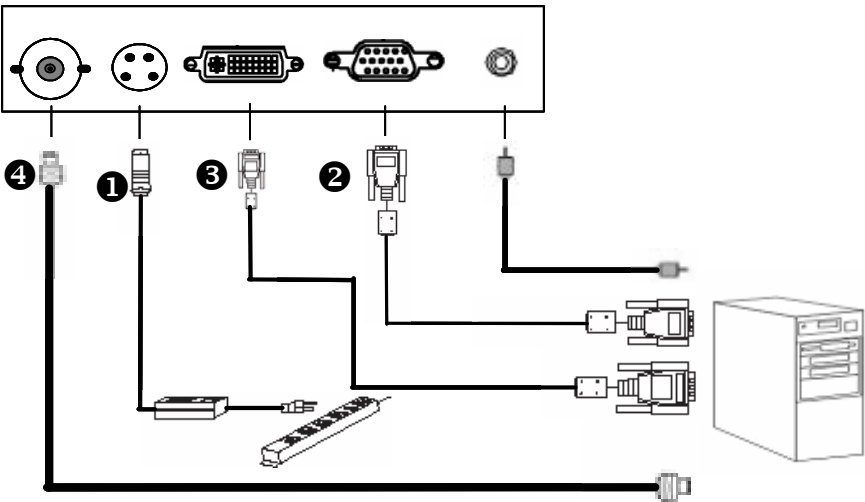

Figure 3. The LB1503R Connections



Notice: To ensure the LCD display will work well with your computer, please configure the display mode of your graphics card to make it less than or equal to 1024 x 768 resolution and make sure the timing of the display mode is compatible with the LCD screen. We have listed the “Compatibility Modes” of this LCD screen in appendices for your reference.

User Controls

Rear Panel Controls

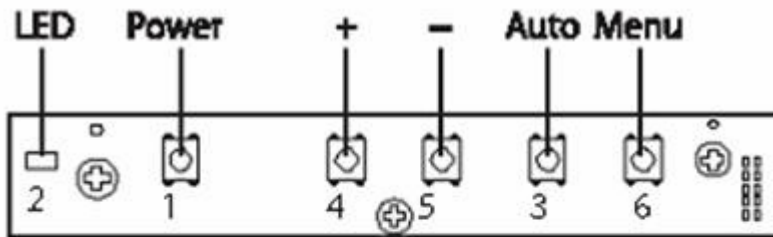

LB 1500R / RTC Controls

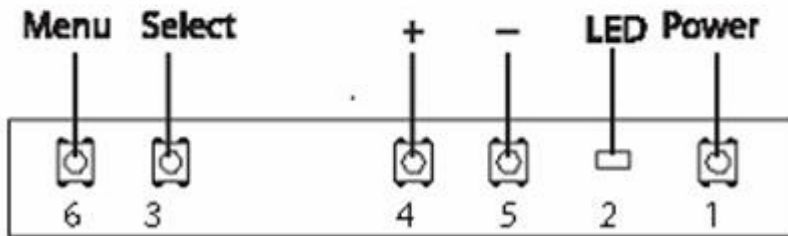

LB1503R Controls

No / Icon	Control	Function
①	Power Switch	Turns on/ off the power of the LCD display.
②	Power LED	Green indicates the display is turned on. Amber indicates the display is in power-saving mode.
③ S	Select/Auto	Select - To select the adjustment items from OSD menus. Auto - To activate the “Auto Adjustment” function to obtain an optimum image.
④	Plus/Brightness	1. Increases the brightness of the display image. 2. Increases value of the adjustment functions.
⑤	Minus/Mute On/Off	1. Decreases value of the adjustment functions. 2. Makes the volume function ineffective/effective.
⑥ M	Menu Button	Display the OSD menus.

How to Use the OSD Menus

1. Press the "MENU" button to pop up the "on-screen menu" and to select among the four main menus.
2. Choose the adjustment items by pressing the "Select/Auto" button.
3. Adjust the value of the adjustment items by pressing the "+" or "-" button.
4. The OSD menu will automatically close if you have left it idle for a pre-set amount of time.
5. To disable the OSD menu buttons, please follow the instructions below. **Please note:** the monitor has to be ON with a valid signal present.
 - a. Press and hold the "--" key.
 - b. With the "--" key held down, press and hold the "Menu" key for 3 seconds.
 - c. The wording "OSD Locked" will appear for 3 seconds on the monitor. This indicates that all the front buttons, with the exception of the power button, are now disabled.
6. To enable the OSD menu buttons, please follow the instructions below. **Please note:** the monitor has to be ON with a valid signal present.
 - a. Press and hold the "--" key.
 - b. With the "--" key held down, press and hold the "Menu" key for 3 seconds.
 - c. The wording "OSD Unlocked" will appear for 3 seconds on the monitor. This indicates that all the front buttons are now enabled.

On-Screen Display Menus

LB1500R/LB1500RTC

Main Menu	Menu Level 2	Function Description	Remark
Page 1	Auto-Adjustment	Choose this function to obtain an optimum image.	
	Contrast	Adjusts the contrast of the display image. The range is 0~100.	Default is 50
	Brightness	Adjusts the brightness of the image. The range is 0~100.	Default is 70
	Horizontal Position	Changes the horizontal position of the image.	
	Vertical Position	Changes the vertical position of the image.	
	Clock	Changes the displays data frequency to match the frequency of your graphics card. When you experience a vertical flickering bar, use this function to make an adjustment.	
	Phase	Synchronizes the signal timing of the display to that of the graphics card. When you experience an unstable flickering image, use this function to make an adjustment.	
Page 2	Display Mode	Select this function to show the display resolution, vertical refresh, and horizontal scan of the current mode.	
	OSD Off-Time	Adjusts how long the OSD menu will be displayed after inactivity. The range is 5~60.	Default is 30
	Language	Opens the Language sub-menu where you can select the desired language of the OSD. Choices include: English, German, Spanish, French, Japanese, Italian.	Default is English
	Sharpness	Adjusts the sharpness of the image.	
	Reset	Resets the display parameters back to its factory default settings.	
Page 3	Volume	Adjusts the sound volume. The range is 0~32.	Default is 20
	Mute	Disables the sound immediately.	
Page 4	Color Setting	Adjusts and customizes color.	
	Color Adjustment-Red	Adjusts the red color of the display. The range is 0~100.	Default is 100
	Color Adjustment-Green	Adjusts the green color of the display. The range is 0~100.	Default is 100
	Color Adjustment-Blue	Adjusts the blue color of the display. The range is 0~100.	Default is 100

LB1503R

Description		Function/Selections	Value Range	Default Setting	
Main Menu	DISPLAY	Brightness	0- 100	60	
		Contrast	0- 100	50	
		Hue	0- 90	0	
		Saturation	0- 100	50	
		Flesh-tone	Off/Weak/Soft/Strong		Off
		Black-Level		0- 100	N/A
	IMAGE	Scaling	1:1/Fill/Aspect/Panorama		Full
		Auto Adjust	Select		
		Phase		0-255	N/A
		Clock		0-255	N/A
	POSITION	Zoom	In / Out		In
		Zoom Horizontal Pan	Left / Right		
		Zoom Vertical Pan	Up / Down		
		Vertical		0-255	N/A
		Horizontal		0-255	N/A
	Color	sRGB	Off / On		Off
		Gamma Correction	Off / 1.8 / 2.2		Off
		Color Temperature	User		
			6500k		6500K
		9300k			
PIP CONTROL	PIP Mode	Off /PIP / Pap		Off	
	PIP size	Small / Med. / Large		Small	
	Vertical		0- 100	20	
	Horizontal		0- 100	85	
Input Select		VGA			
		DVI			
		Composite			
OSD Position		Vertical	0-255	0	
		Horizontal	0-255	0	
		Blend	0-10	0	
		Time Out	5-60	30	
Language		English		English	
		Chinese			
		Japanese			
Reset		Factory Reset			
Audio		Volume	0-50		
		Mute	On / Off	On	

Appendix

Troubleshooting

If you are experiencing trouble with the LCD display, refer to the following. If the problem persists, please contact Planar.

Problem: No image appears on screen.

- Check that all the I/O and power connectors are correctly installed and well connected as described in the "Installation" section.
- Make sure the pins of the connectors are not crooked or broken.
- Reconfigure the resolution of your computer to make it less than or equal to 1024 x 768.

Problem: Partial Image or incorrectly displayed the image.

- Check to see if the resolution of your computer is higher than that of the LCD display.
- Reconfigure the resolution of your computer to make it less than or equal to 1024 x 768.

Problem: Image has vertical flickering line bars.

- Use "Clock" to make an adjustment.
- Check and reconfigure the display mode of the vertical refresh rate of your graphic card to make it compatible with the LCD display.
- Problem: Image is unstable and flickering
- Use "Phase" to make an adjustment.

Problem: Image is scrolling

- Check and make sure the VGA signal cable (or adapter) is well connected.
- Check and reconfigure the display mode of the vertical refresh rate of your graphics card to make it compatible with the LCD Display.
- Problem: Ghosting image (character and graphic images)
- Use "Clock" to make an adjustment. If this problem still exists, use "Phase" to make an adjustment.

Warning Signal

If you see warning messages on your LCD screen, this means that the LCD display cannot receive a clean signal from the computer graphics card.

There are three kinds of sources for this problem. Please check the cable connections or contact Planar for more information.

No Signal

This message means that the LCD Display has been powered on but it cannot receive any signal from the computer graphics card. Check all the power switches, power cables, VGA, DVI or Video signal cables.

Going to Sleep

This message means that the LCD display is under the power saving mode. In addition, the LCD display will enter the sleeping mode when experiencing a sudden signal disconnecting problem.

Unsupported Mode

This message means that the signal of the computer graphics card or video source is not compatible with the LCD display. The LCD display will show this message when the signal is not included in the Signal Compatibility mode tables listed in the Appendix of this manual.

Product Dimensions (All dimensions are in millimeters)

LB1500R

Front View

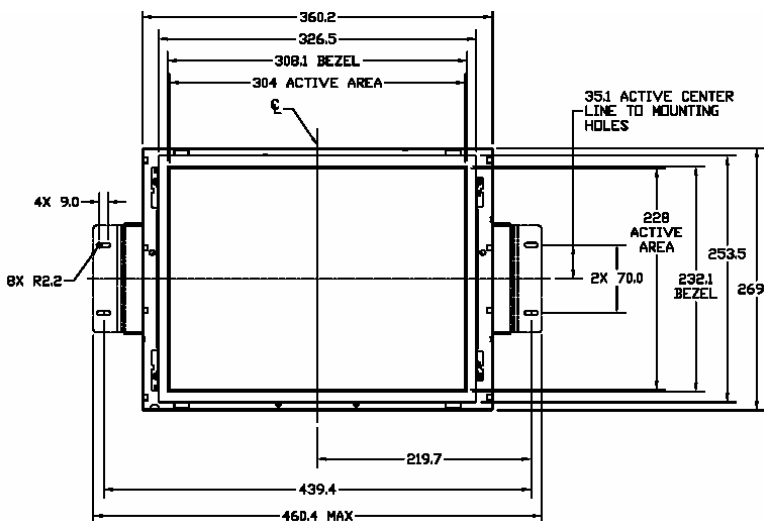

LB1500RTC

Front View

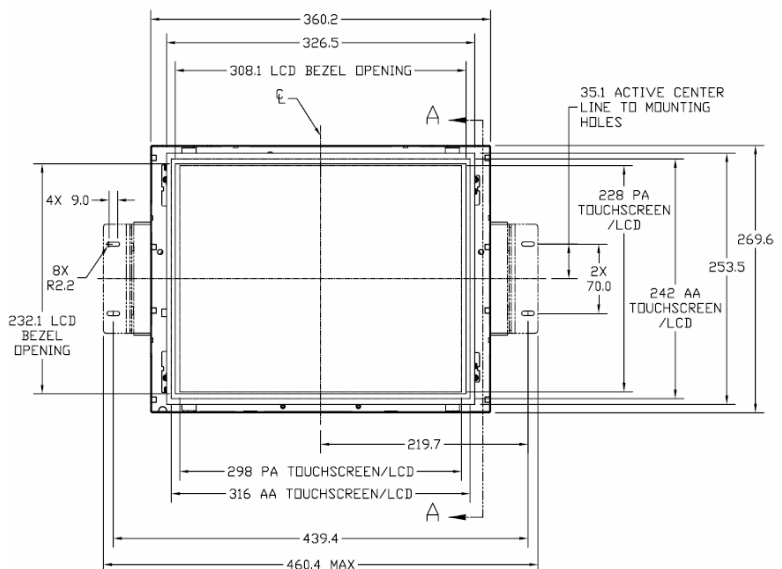

LB1500R/LB1500RTC

Back View

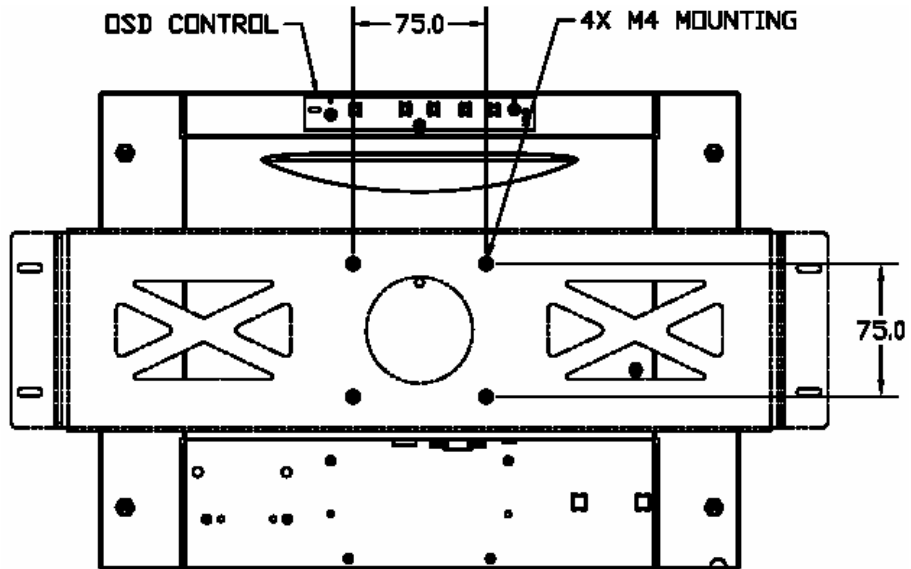

LB1500R Side View

LB1500RTC Side View

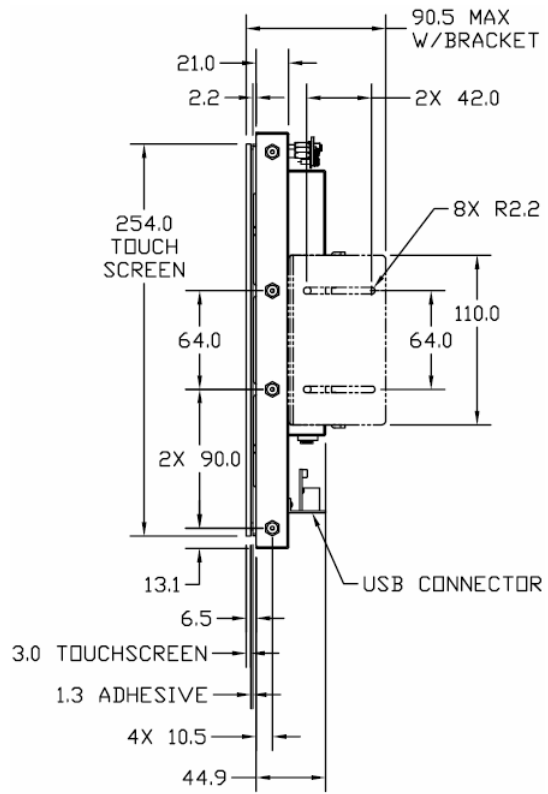

LB1503R

Front View

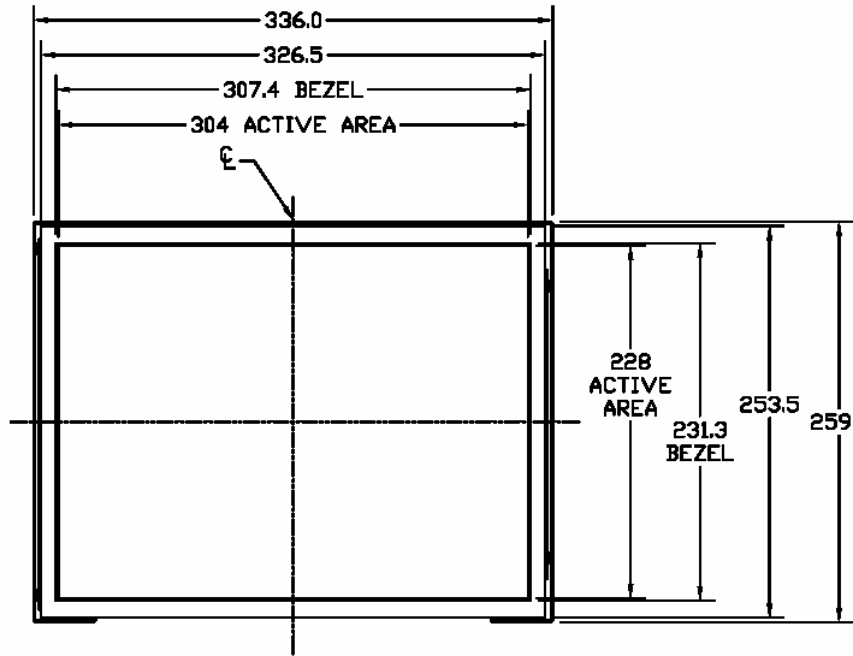

LB1503R

Back View

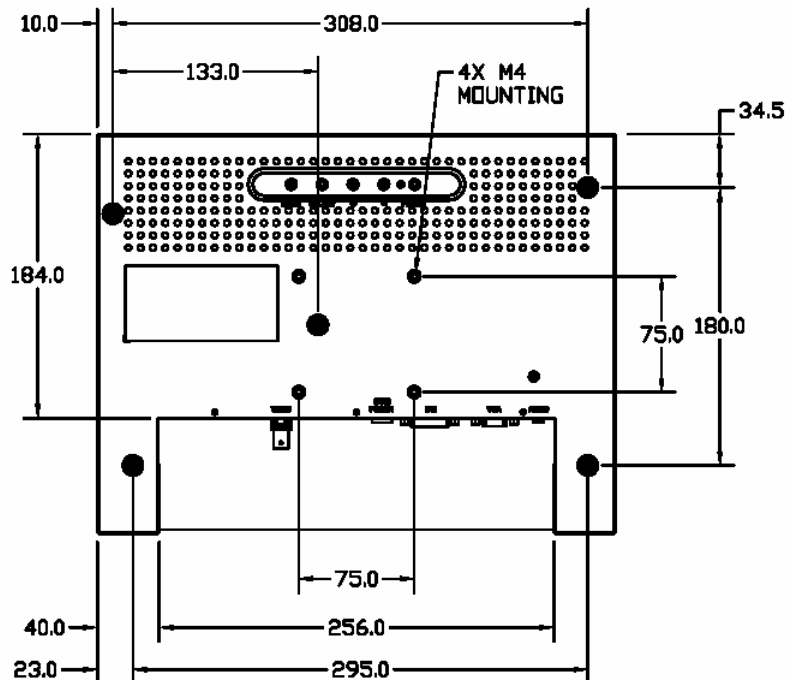

LB1503R

Side View

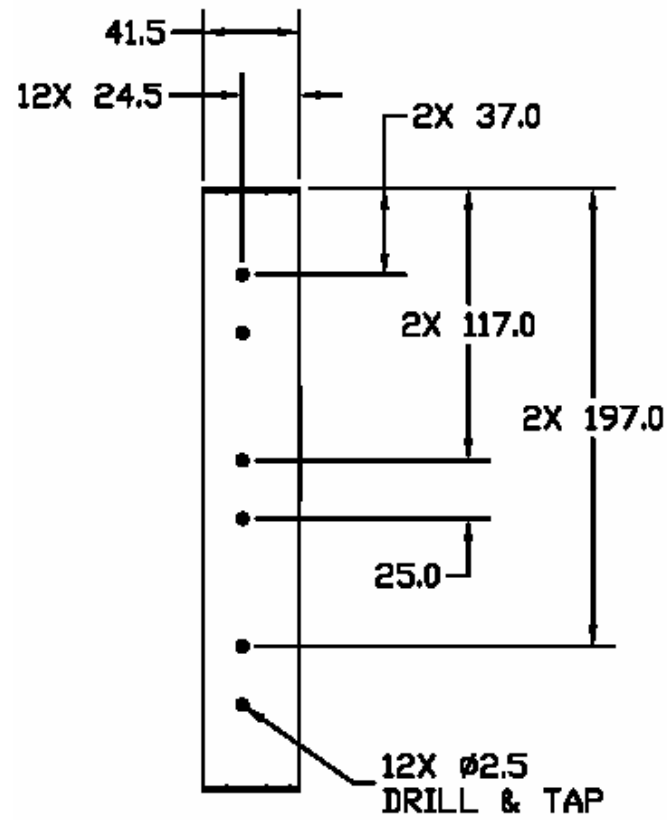

Signal Compatibility Modes

LB1500R, LB1500RTC and LB1503R

Graphics Analog Signal Support

Table 1

Item	Comment	Resolution	Vertical Refresh Rates
1	IBM & VESA VGA	640 x 350	70 Hz
2	IBM VESA VGA	640 x 400	70 Hz
3	IBM VESA VGA	720 x 400	70 Hz
4	IBM VESA VGA	640 x 480	60 Hz, 72 Hz, 75 Hz
5	VESA SVGA	800 x 600	56 / 60 / 72 / 75 Hz
6	VESA XGA	1024 x 768	60 / 70 / 75 Hz
8	Apple Mac LC	640 x 480	67 Hz
9	Apple Mac II	640 x 480	67 Hz
10	Apple Mac	832 x 642	75 Hz
11	Apple Mac	1024 x 768	75 Hz

LB1503R

Graphics Digital Signal Support

Table 2

Item	Comment	Resolution	Vertical Refresh Rates
1	IBM & VESA VGA	640 x 350	70 Hz
2	IBM VESA VGA	640 x 400	70 Hz
3	IBM VESA VGA	720 x 400	70 Hz
4	IBM VESA VGA	640 x 480	60 Hz, 72 Hz, 75 Hz
5	VESA SVGA	800 x 600	56 / 60 / 72 / 75 Hz
6	VESA XGA	1024 x 768	60 Hz
8	Apple Mac LC	640 x 480	67 Hz
9	Apple Mac II	640 x 480	67 Hz
10	Apple Mac	832 x 642	75 Hz
11	Apple Mac	1024 x 768	75 Hz

Analog Video Signal Support

Table 3

Item	Comment	Resolution	Vertical Refresh Rates
1	NTSC	525 Lines	60 Hz
2	PAL	600 Lines	50 / 60 Hz

Touch Screen Driver Installation

Driver Installation for LB1500RTC: Capacitive Touch Screen with USB Connection

Touch driver information is located on the enclosed CD-ROM for the following operating systems: Microsoft® Windows® 2000, XP, CE, XP Embedded, Windows® Server-2003 and Linux.

1. Be sure that the USB cable is not connected to the PC.
2. Open the CD-Rom.
3. Click “I accept” when the software license screen appears.
4. Click the “LA1500RTC, LA1710RTC, LA1910RTC” link for the appropriate operating system.
5. Follow the step-by-step instructions.
6. Reconnect the USB cable to the computer prior to use.
7. If the touch screen driver does not automatically load, restart the computer operating system.

Please read “Readme.txt” located in the unzipped file folder for additional information and assistance.

Appendix

Planar is a US company based in Beaverton, Oregon and Espoo, Finland with a worldwide sales distribution network.

Visit Planar at <http://planar.com/support> for product registration, operations manuals, line drawings, touch screen drivers, warranty information and access to planar's Technical Library for online troubleshooting.

To speak with Planar Customer Support please have you model and serial number available and dial:

Support

Tel: 1-866-PLANAR1 (866-752-6271) or +1 503-7408-5799 outside the United States.

Hours: M-F, 3am – 7pm Pacific Time, 11:00 – 03:00 GMT

Toll or long distance charges may apply.

Planar Systems, Inc.

Customer Service

24x7 Online Technical Support: <http://www.planar.com/support>

Support

1195 NW Compton Drive

Beaverton, OR 97006-1992

Tel: 1-866-PLANAR1 (866-752-6271) or +1 503-748-5799 outside the United States.

Hours: M-F, 3am - 7pm Pacific Time, 11:00 – 03:00 GMT

© 2007 **Planar Systems, Inc. 03/07** Planar is a registered trademark of Planar Systems, Inc.

Other brands and names are the property of their respective owners.

Technical information in this document is subject to change without notice.

020-0463-01A

Free Manuals Download Website

<http://myh66.com>

<http://usermanuals.us>

<http://www.somanuals.com>

<http://www.4manuals.cc>

<http://www.manual-lib.com>

<http://www.404manual.com>

<http://www.luxmanual.com>

<http://aubethermostatmanual.com>

Golf course search by state

<http://golfingnear.com>

Email search by domain

<http://emailbydomain.com>

Auto manuals search

<http://auto.somanuals.com>

TV manuals search

<http://tv.somanuals.com>