



**LC1502R**  
**USER'S MANUAL**

[www.planar.com](http://www.planar.com)

# Table of Contents

## Usage Notice

Safety and Use Precautions .....	3
----------------------------------	---

## Introduction

About the LC1502R .....	4
Package Overview .....	5

## Installation

Product Overview .....	6
Connector Descriptions .....	7
Mounting .....	8
Start Your Installation .....	9

## User Controls

Control Buttons .....	10
How to Use the OSD Menus .....	11
<i>On-Screen Display Menus</i> .....	11

## Brightness Control

Automatic Brightness Control .....	13
Manual Brightness Control .....	14
Minimum Brightness Limit .....	15
Maximum Brightness Mode .....	16

## Specifications

Electrical and Optical .....	17
Mechanical and Environmental .....	18
Compatible Video Modes .....	18
Reliability and Life .....	19
Safety and Regulatory Certifications .....	19

## Available Options

Power Supply and AC Power Cord .....	20
Cooling Kit .....	21
Touch Screens .....	22
<i>NFI Touch Screen</i> .....	22
<i>Capacitive Touch Screen</i> .....	24

## Appendix

Troubleshooting .....	25
Warning Signal .....	25
Mechanical Outline .....	26
Warranty .....	27
Support and Service .....	27

# Usage Notice

**Warning -** To prevent the risk of fire or shock hazards, do not directly expose this product to rain or moisture.

**Warning -** Please do not open or disassemble the product as this may cause electric shock.

## Safety and Use Precautions

*Follow all warnings, precautions and maintenance as recommended in this User's Manual to maximize the life of your monitor.*

- Turn off the product before cleaning.
- Use only a dry soft cloth or clean room wiper when cleaning the LCD panel surface.
- Use a soft cloth moistened with mild detergent to clean the monitor housing.
- Use only a high-quality and safety-approved 12V power supply.
- Do not touch the LCD panel surface with sharp or hard objects.
- Do not use abrasive cleaners, waxes or solvents for cleaning.

# Introduction

## About the LC1502R

The LC1502R is a high performance monitor designed for demanding applications. The monitor consists of a 15" diagonal flat panel liquid crystal display (LCD) housed in a metal enclosure with an integrated ambient light sensor to facilitate automatic brightness control.

### Features include:

- Very high bright 1000 cd/m<sup>2</sup> brightness for sunlight readability
- Automatic brightness control to auto adjust the brightness to ambient conditions
- Manual brightness control mode to allow the user to control the brightness
- Wide 0 - 50°C operating temperature range
- Long backlight life: >40000 hours operating time before reaching half brightness
- Rugged vibration and shock characteristics
- Conformance to FCC/EN55022 Class B for low EMI
- 1024 x 768 XGA resolution
- Auto-adjustment function for jitter-free operation
- Optional cooling kit to reduce solar loading
- Optional 12V AC/DC power supply
- Optional capacitive and NFI touch screens

## Package Overview

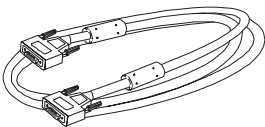
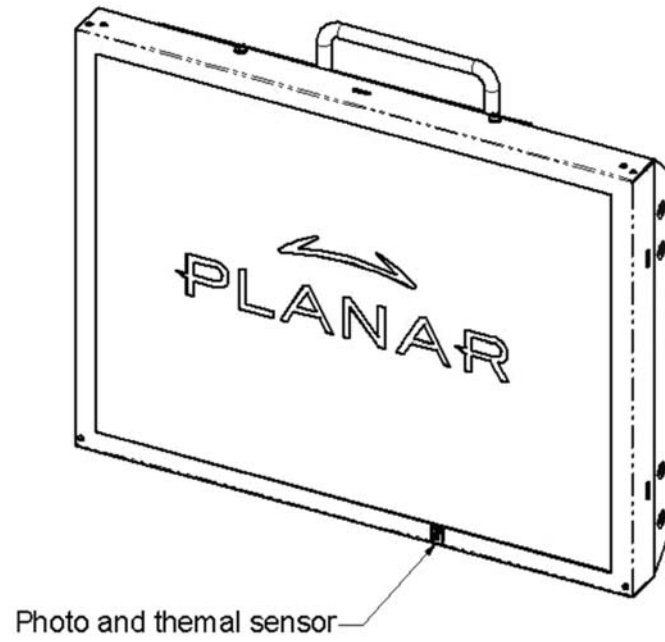

VGA Signal Cable

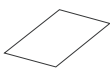

Quick Start Guide

# Installation

## Product Overview

- Front View

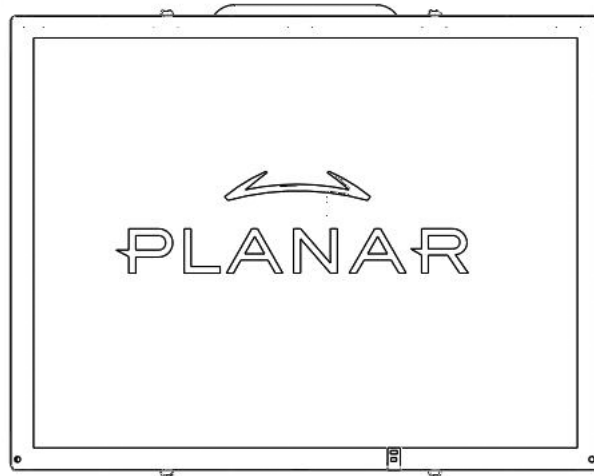

- Rear View

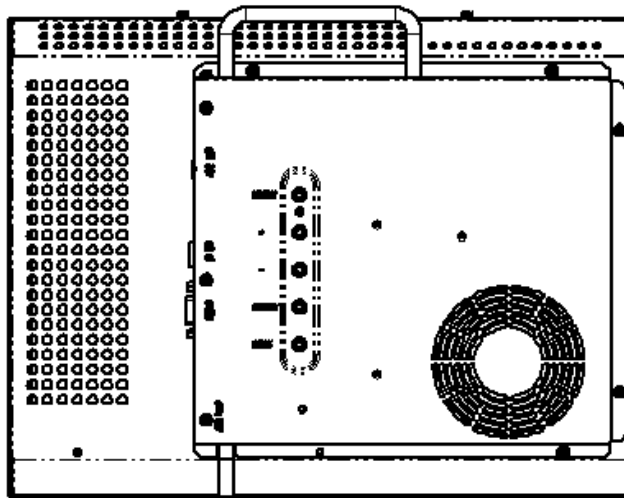

## Connector View

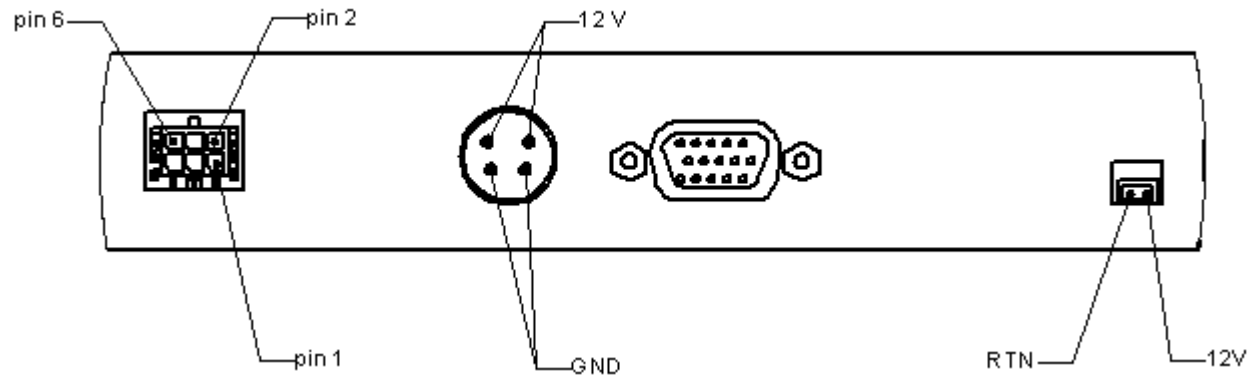

## Connector Descriptions

### 1. Video Interface Connector

Standard D-sub Analog; 15-pin D-sub connector

### 2. Power Input Connector

Connector type: 4-pin mini DIN socket

Manufacturer: Singatron Enterprise Co. (Taiwan)

Part Number: 2MJ-0402A120

Mating Connector: 2MP-0402 series

### Power Connector Pin Configuration

Pin	Description
1	+12V DC
2	+12V DC
3	Ground
4	Ground

### 3. External Dimming Connector

Connector type: Molex Micro Fit 3.0

Mating connector: Molex 43025-0600 (housing) and Molex 43030 (terminals)

#### External Dimming Connector Pin Configuration and Description

Pin	Name	Description
1	Ground	Electrical ground
2	Reserved	For factory use only, leave unconnected
3	DIM_Input	0-5V analog input for external dimming, connect to wiper of dimming pot if used
4	/Ext_DIM,	Input to determine brightness control mode; has 10k pull up to +5V Logic high (or unconnected) = Automatic Brightness Control mode Logic low = Manual Brightness Control mode
5	Ground	Electrical ground; connect to lower leg of dimming potentiometer if used
6	Vref	+5V reference voltage output with 470 ohm series resistance; connect to upper leg of dimming potentiometer if used

### 4. Cooling Kit Power Output Connector

Note: There is no need to connect to this connector. Information is shown for reference only. If a Cooling Kit option is ordered, the required cooling kit power cable will be installed at the factory.

#### Optional Cooling Kit Pin Configuration

Pin	Description
1	Switched Return
2	+12V output

## Mounting

M4 threaded holes are provided in the sides of the monitor housing for mounting purposes. The blind holes will accommodate 10 mm long screws. See the mechanical outline drawing 076-0579-00 at [www.planar.com/support](http://www.planar.com/support) for details.



## Start Your Installation

### Connecting the Display (Figure 1.0)

To configure the monitor, please refer to the following figure and procedures.

1. Be sure the computer or video source is turned off.
2. Connect the 12V DC power(1.0). During initial turn on with no video applied, the display will automatically power on with a self test pattern displayed. The self test pattern consists of alternating screens of black, white, red, green, and blue.
3. Connect the VGA signal cable from display VGA input connector to the 15-pin connector of your host computer and tighten the screws(1.0).
4. If needed, connect to the external dimming connector(1.0). See details in the Brightness Control section of this document.
5. Turn on your computer or video source.

**Note:** Once video is applied, self test mode is automatically cancelled and will no longer function when video is removed.

**Notice:** To ensure the LCD display will work well with your system, please configure the display mode of your graphic card for a 1024 x 768 resolution and a 75 Hz refresh rate.



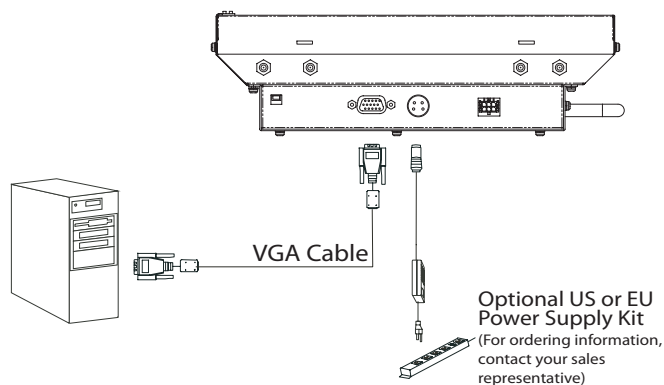



Figure 1.0

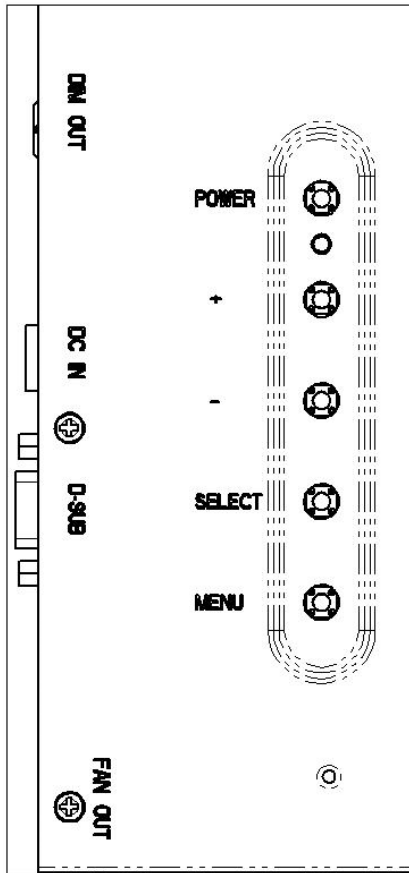

# User Controls

## Control Buttons



No./ Icon	Control	Function
	Menu button	Displays the OSD menu
	Select/Auto	<i>Select-</i> To select the adjustment items from OSD menu. <i>Auto-</i> To activate the "Auto Adjustment" function to obtain an optimum image.
	Brightness Minus/Minus	1. Decreases the value of the adjustment items. 2. Decreases the minimum brightness limit of the display image.
	Brightness Plus/Plus	1. Increases the value of the adjustment items. 2. Increases the minimum brightness limit of the display image.
	Power Switch	Switches on/off the power of the LCD display.
	Power LED	1.Green indicates the display is turned on. 2. Amber indicates the display in power-saving mode.

## How to Use the OSD Menu

1. Press the "Menu" button to pop up the on-screen menu and to select between the four main menus.
2. Choose the adjustment items by pressing the "Select/Auto" button.
3. Adjust the value of the adjustment items by pressing the "+" or "-" button.
4. The OSD menu will automatically close if you have left it idle for a pre-set time.

## On-Screen Display Menus

### *First OSD Menu:*

Auto-Adjustment

Contrast

Horizontal Position

Vertical Position

Frequency

Tracking

Minimum Brightness Limit

- **Auto-Adjustment**

Choose this function to obtain an optimum image.

- **Contrast**

This function allows the user to adjust the image crispness. Contrast adjusts the difference between white and black shades.

- **Horizontal Position**

Changes the horizontal position of the image.

- **Vertical Position**

Changes the vertical position of the image.

- **Frequency**

Changes the display data frequency to match the frequency of the graphic card. If a vertical flickering bar is seen, use this function to make an adjustment.

- **Tracking**

Synchronizes the signal timing of the display with the graphic card. If an unstable or flickering image is seen, use this function to make an adjustment.

**Second OSD Menu:**

Display Mode  
OSD Off-Time  
Language  
Text-Graphic  
Reset

**• Display Mode**

The display mode shows the display resolution, horizontal scan frequency, and vertical refresh of the current mode.

**• OSD Off-Time**

Adjusts the time period for OSD menu to disappear.

**• Language**

Allows menu language selection from among English (default), German, Italian, French, Spanish, and Japanese

**• Text-Graphic**

Toggles between VGA text mode (mode M03H) and graphic mode (mode M13H).

**• Reset**

Returns the display parameters to its factory default settings.

**Third OSD Menu:**

Color Setting  
Color Adjustment-Red  
Color Adjustment-Green  
Color Adjustment-Blue

**• Color Setting**

Adjusts the color temperature.

**• Color Adjustment-Red**

Adjusts the red color of the display.

**• Color Adjustment-Green**

Adjusts the green color of the display.

**• Color Adjustment-Blue**

Adjusts the blue color of the display.

# Brightness Control

The brightness of the monitor may be controlled automatically or manually, and the minimum brightness is adjustable. By default, the monitor is configured for automatic brightness control with a minimum brightness setting of approximately 250 cd/m<sup>2</sup>.

## Automatic Brightness Control

In automatic brightness control mode, a photo sensor mounted on the front of the display measures the ambient lighting condition (the illuminance). The monitor automatically and continually adjusts its brightness to accommodate the ambient environment. In moderately bright environments the monitor will reach maximum brightness. In dimly lit environments the monitor will operate at minimum brightness.

The graph below shows the factory set response to ambient lighting conditions. Note that a typical office environment is 300 to 500 lux, while a typical cloudy day is roughly 1000 lux.

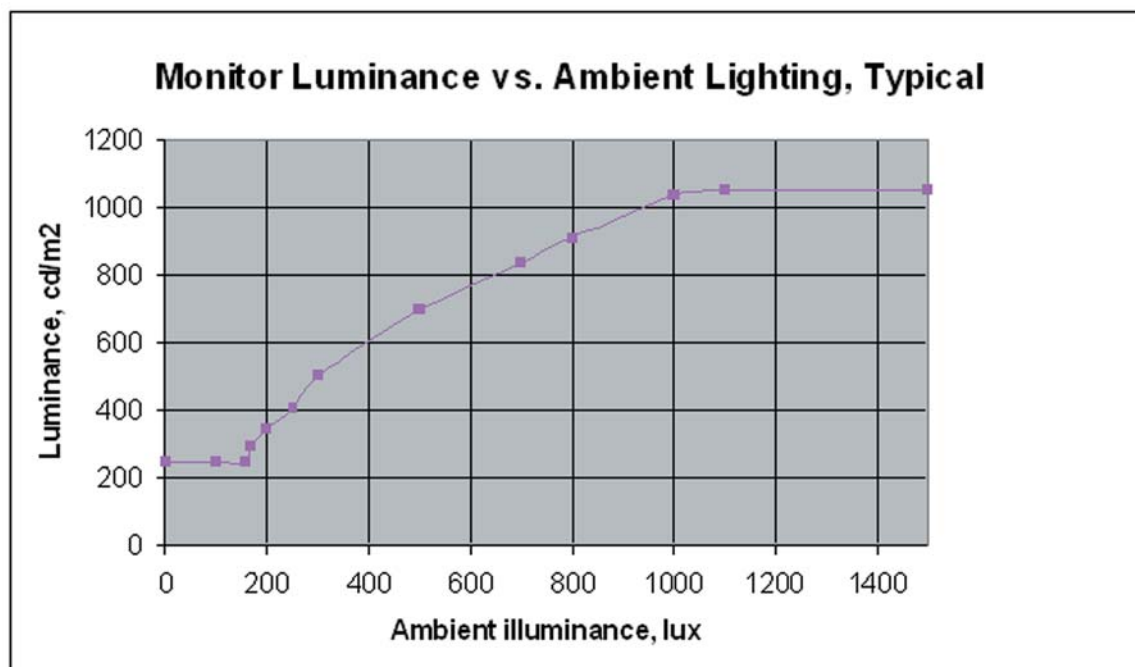

## Manual Brightness Control

In manual brightness control mode, an externally supplied voltage determines the monitor brightness.

To use manual brightness control mode instead of the default automatic brightness control mode:

1. set pin 4 (/EXT\_DIM) of the external dimming connector (J1) to a logic low
2. apply a 0 to 5V analog input to pin 3 (DIM\_INPUT) of the external dimming connector

A potentiometer may be used to apply the voltage to the DIM\_INPUT, as shown in the figure below. A 20k pot or higher is recommended. Note that VREF is a 5V regulated voltage supplied through a 470 ohm series resistance.

**Important note!** Do not connect to pin 2!

Manual brightness control using a potentiometer

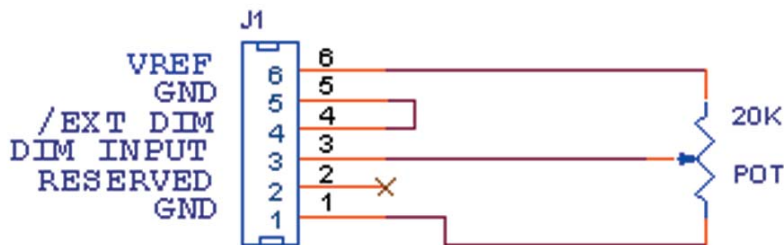

The graph below shows the typical factory set response to the DIM\_INPUT voltage when in manual brightness control mode.

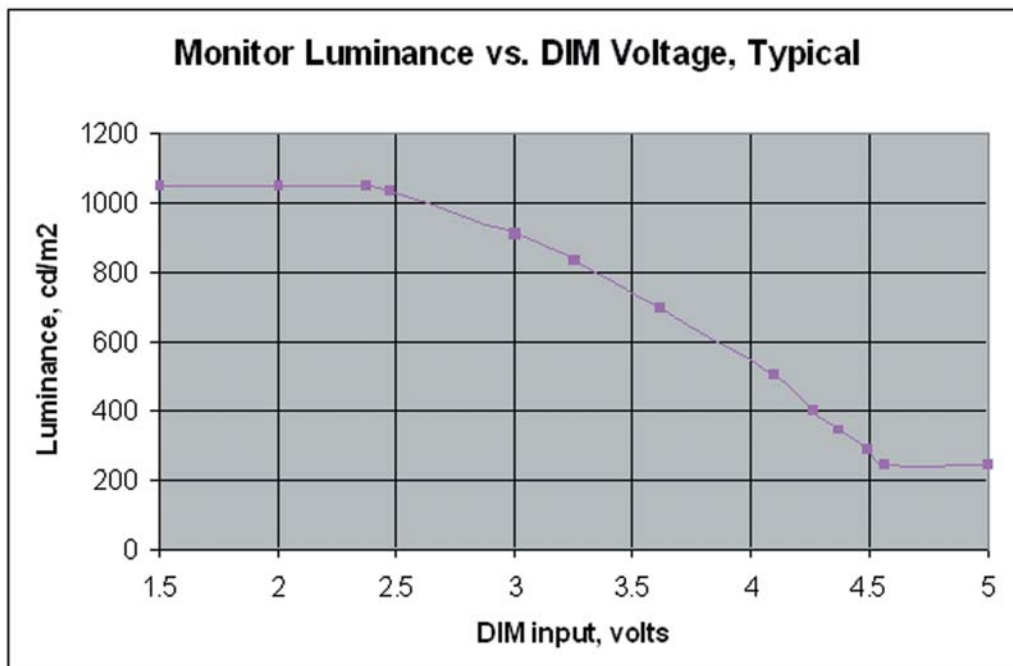

## Minimum Brightness Limit

The factory set minimum brightness is approximately 250 cd/m<sup>2</sup>. In most applications the factory setting is desired to maintain the widest dimming range possible. But for applications where 250 cd/m<sup>2</sup> is too low but some dimming is still desired, the minimum brightness limit may be increased. The OSD controls are used to access and change the minimum brightness limit setting, as described in the User Controls section of this manual.

Below is a graph showing the typical minimum brightness limit for a given OSD setting:

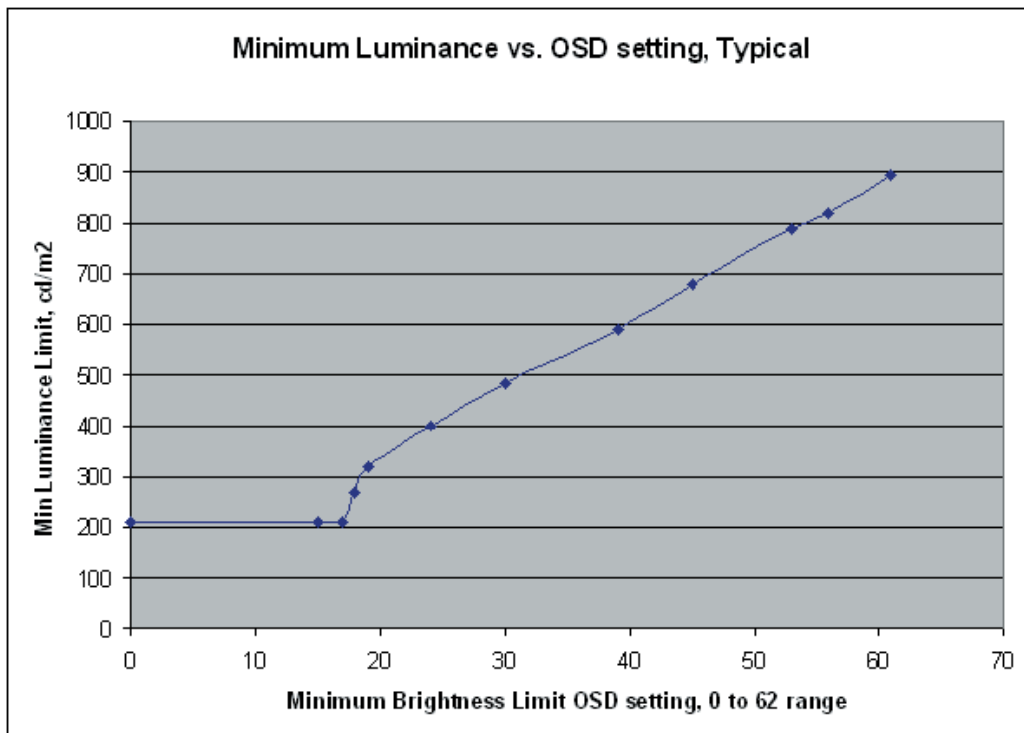

To change the minimum brightness limit, one of three basic methods can be used:

1. If one wishes to set an approximate minimum brightness, the above graph may be used. For instance, to set the minimum to typically 400 cd/m<sup>2</sup>, set the minimum brightness limit to an OSD setting of 25. Note, however, that there may be significant (+/- 50%) luminance variation for a given OSD setting due to display variation.
2. To set the minimum brightness visually, one may set the dimming to a minimum (by covering the photo sensor on the front of the monitor if in automatic brightness control mode, or by setting the DIM\_INPUT to 5V if in manual brightness control mode) and then adjust the OSD setting to visually give the desired result.
3. To quantitatively set the minimum brightness to a desired luminance, one may set the dimming to a minimum and then adjust the OSD setting to give the desired result as measured by a photometer (such as the Tektronix J17 with a J1803 luminance head.) Note that a ten minute monitor warm up period with the monitor set near its minimum brightness is recommended to allow for an accurate measurement.

As with any OSD setting, a change to the minimum brightness limit will be permanently stored and will be unaffected by turning off the monitor power.

The minimum brightness limit will affect the minimum brightness of both the automatic brightness control mode and the manual brightness control mode identically. Below is a graph showing the impact of various minimum brightness limit settings on the automatic brightness control mode.

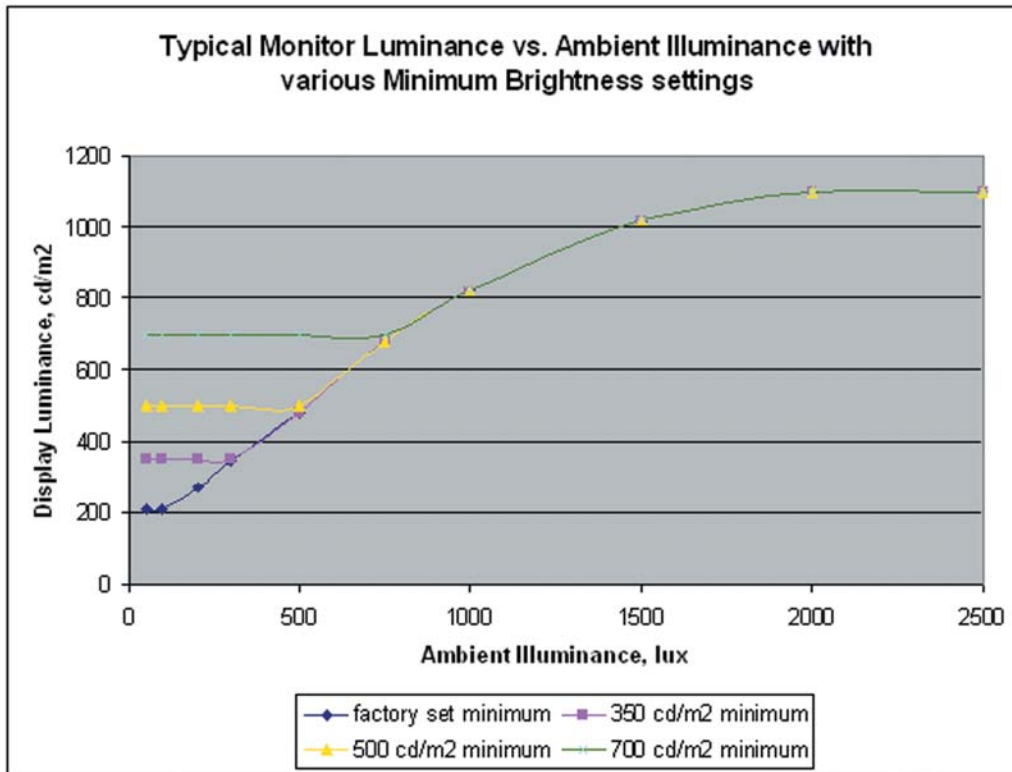

## Maximum Brightness Mode

If a constant maximum brightness is desired, simply connect both the DIM\_INPUT and the /EXT\_DIM inputs of connector J1 to ground. The monitor will then be set to the maximum brightness.

Alternatively, one may avoid the need to connect to the dimming connector by using the OSD to set the minimum brightness limit to the maximum value of 62. This will set the minimum brightness to typically 900 cd/m<sup>2</sup>, which is very close to the maximum brightness. The resulting monitor brightness range of approximately 900 to 1050 cd/m<sup>2</sup> will yield brightness changes largely undetectable by the end user.



# Specifications

## Electrical and Optical

Parameter	Min	Typ	Max	Units	Conditions/Notes
Input Power, Voltage	11.4	12.0	12.6	volts	
Input Power, Current		3.95	4.3	amps	
Monitor Power Consumption		47.4	49.2	watts	
Logic High	4.0	5	5.4	volts	For logic inputs
Logic Low	-0.4	0	1.0	volts	For logic inputs
DIM input voltage	0		5	volts	Analog input
Maximum White Luminance <sup>1,2</sup>	950	1050		cd/m2	Center; Normal
Minimum White Luminance <sup>1,3</sup>		250		cd/m2	Center; Normal
Dimming range <sup>4</sup>		4:1			Ratio of max lum/min lum
Luminance Uniformity <sup>2</sup>	69	78		%	9-point; 10% from edge
Contrast Ratio <sup>1,2</sup>	200	350			White/black, Center
Horizontal Viewing Angle		±80		deg	Contrast ratio > 5
Vertical Viewing Angle		+53/-56		deg	Contrast ratio > 5
Response Time		16	23	msec	rise time + fall time
Screen Diagonal, viewable		15		inches	
Active Display Area		304.1 x 228.1		mm	
Resolution		1024 x 768		pixels	
Pixel Pitch		0.297		mm	
Number of Supported Colors		262144			

Note 1: 25°C steady state conditions at initial use

Note 2: No dimming

Note 3: With maximum dimming and factory set minimum brightness limit

Note 4: With factory set minimum brightness limit

## Mechanical and Environmental

Parameter	Specification
Operating Temperature	0 to 50°C
Operating Humidity	30 to 85% RH, non-condensing
Storage Temperature	-20 to 60°C
Storage Humidity	10 to 85% RH, non-condensing
Active Area Surface Treatment	Anti-glare, 3H hard coating
Weight	< 3 kg
Mechanical Shock shocks per axis	Half sine wave, 30g, 11ms, 3
Sine sweep vibration, operating	10~500 Hz, 0.25g o-p, 0.25 oct / min
Random sweep vibration, operating	10~500 Hz, 0.002 g <sup>2</sup> /Hz, 1 grms, 1 hr / axis
Sine sweep vibration, non-operating	10~500 Hz, 0.75g o-p, 0.5 oct / min
Random sweep vibration, non-operating	10~500 Hz, 0.0082 g <sup>2</sup> /Hz, 2 grms, 1 hr / axis

## Compatible Video Modes

Mode	Resolution	V. Frequency (Hz)	H. Frequency (kHz)
IBM VGA	640 x 350	70	31.5
IBM VGA	640 x 400	70	31.5
IBM VGA	640 x 480	60	31.5
IBM VGA	720 x 400	70	31.5
VESA VGA	640 x 480	72	37.9
VESA VGA	640 x 480	75	37.5
VESA SVGA	800 x 600	56	35.2
VESA SVGA	800 x 600	60	37.9
VESA SVGA	800 x 600	72	48.1
VESA SVGA	800 x 600	75	46.9
VESA XGA	1024 x 768	60	48.4
VESA XGA	1024 x 768	70	56.5
VESA XGA	1024 x 768	75	60.0
Apple Mac	640 x 480	67	34.9
Apple Mac	640 x 480	67	35.0
Apple Mac	832 x 624	75	49.7
Apple Mac	1024 x 768	75	60.2

## Reliability and Life

Parameter	Specification
Mean Time Between Failures	20k hours at 25°C, 90% confidence level
Time to 50% brightness decay from initial brightness	40k hours minimum at 25°C, operating continuously at maximum brightness

## Safety and Regulatory Certifications

- A. FCC Certification  
FCC Part 15, Subpart B, Class B - Conducted and Radiated Tests
- B. CE Certification

### Emission

EN 55022:1998+A1:2000+A2:2003; Class B	Conducted & Radiated Test
EN61000-3-2:2000, Class D	Harmonic Current Emissions
EN61000-3-3:1995+A1:2001	Voltage Fluctuations and Flicker

### Immunity (EN 55024:1998+A1:2001)

IEC 61000-4-2: 2001	Electrostatic discharge immunity test
IEC 61000-4-3: 2002	Radiated, radio-frequency, electromagnetic field immunity test
IEC 61000-4-4: 1995+A1:200+A2:2001	Electrical fast transient/ burst immunity test
IEC 61000-4-5: 2001	Surge immunity test
IEC 61000-4-6: 2001	Immunity to conducted disturbances, induced by radio-frequency fields
IEC 61000-4-8: 2001	Power frequency magnetic field immunity test
IEC 61000-4-11: 2001	Voltage dips, short interruptions and voltage variations immunity tests

C. UL/CUL Certification

TUV Certification

# Available Options

## Power Supply and AC Power Cord

The LC1502R requires a 12VDC power input. Many users will have the required 12VDC available in their existing system. Alternatively, a power supply that is appropriately rated for the LC1502R is available from Planar. The supply is available with the AC power cord configured with either a European plug or a US plug.

<b>12V Power Supply Kit, Euro type</b>	<b>997-2825-xx</b>
<b>12V Power Supply Kit, US type</b>	<b>997-2826-xx</b>
Input voltage	90-265 VAC, 47-63 Hz
Output voltage	12 VDC
Rated Output Current	6.67A max
Case Dimensions	129 x 77 x 40 mm
DC output cord length	1.8 meters
AC input power cord length	1.8 meters

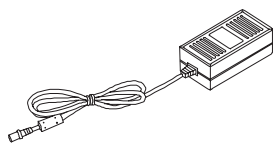

Power Adapter

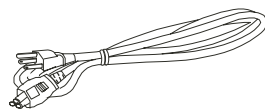

Power Cord

## Cooling Kit

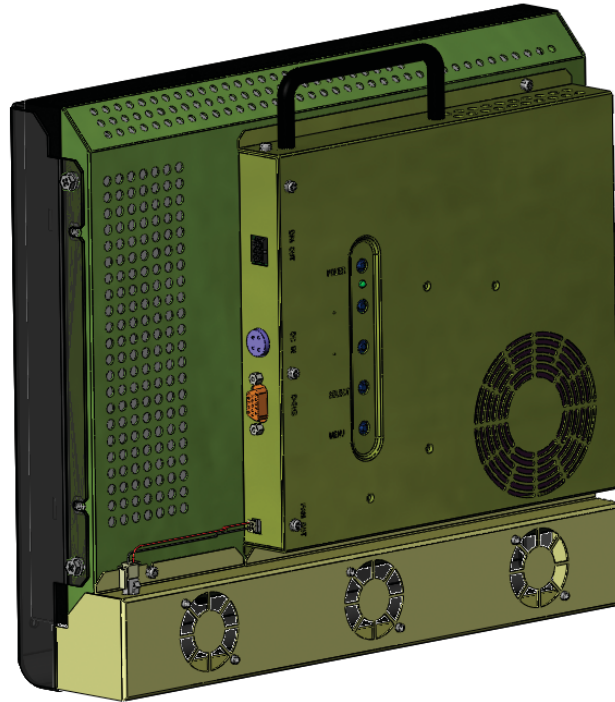

For outdoor applications, a cooling kit may be desired to prevent excessive heating of the LCD display.

In direct sunlight, the front surface of the display (the LCD cell) may reach temperatures well above the ambient temperature. Possible effects of extreme surface temperatures include:

- LCD polarizer damage (permanent degraded image)
- LCD fluid clearing (display unreadable)
- Latent image (image burn-in visible)
- Flicker (image jitter)
- Localized non-uniformity (permanent spotty appearance).

The cooling kit consists of a rear-mounted housing containing three fans and a front-mounted baffle that channels the air flow across the display surface. The fans' speed is governed by a temperature sensor adjacent to the photo sensor that is mounted on the front of the monitor. At temperatures above 30°C the fans will turn on at low speed and reach maximum speed at 40°C, thus minimizing the effects of sun loading and high temperatures.

The total fan kit power consumption is approximately 3.6 watts with fans at max speed. Fan power is derived from the 12V input (4-pin DIN connector.)

All cooling kit version monitors are shipped with the cooling kit pre-installed.

Model	Planar Part Number	Description
LC1502R-C	997-2823-xx	LC1502R with cooling kit

## Touch Screens

The LC1502R is available with two different types of touch screen technology: near field imaging (NFI) and capacitive. Both come pre-installed; the touch screen itself is mounted to the front of the monitor and the touch screen controller module is mounted on the back. NFI technology utilizes a thick glass substrate that provides “vandal-proof” protection. Capacitive technology is more rugged than resistive, and is usually the touch screen of choice for heavy use, unattended environments. Contact Planar for additional details or other custom possibilities.

Model	Planar Part Number	Description
LC1502RTC	997-2817-xx	LC1502R with capacitive touch screen
LC1502RTN	997-2824-xx	LC1502R with NFI touch screen and cooling kit

### NFI Touch Screen

LC1502R with NFI Touch Screen and Cooling Kit

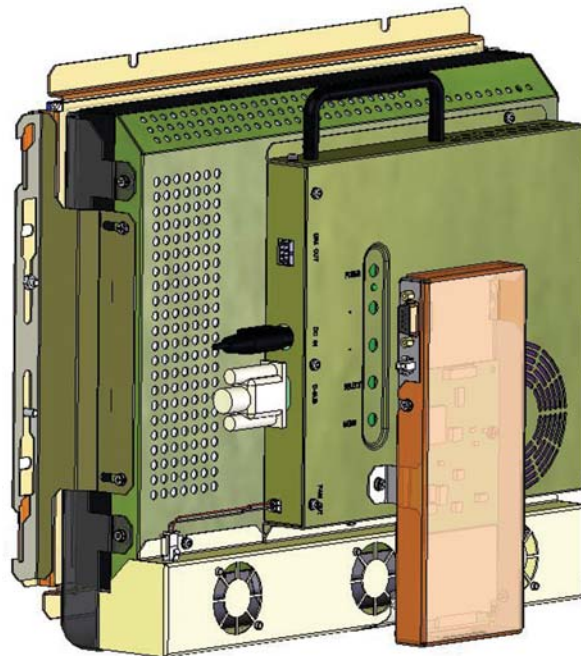

The LC1502R with NFI touch screen and cooling kit – model LC1502RTN-C is designed to be embedded into kiosks installed in outdoor unsupervised environments. It includes a NFI “vandal-proof” touch screen, neoprene weather seals, and a LCD surface cooling kit. The NFI touch controller is mounted to the back of the unit. The mounting bracket, bolted to each side of the unit, hooks onto the touch screen bezel, houses the touch screen and the seals which absorb shock and virtually eliminates the ingress of liquids. The monitor may easily be removed from the touch bezel for cleaning and maintenance.

## Set up

1. Refer to Planar mechanical outline drawing 076-0596-xx for the recommended mounting pattern for this display.
2. Separate the LCD monitor from the touch bezel for mounting.
  - a. Remove the controller cover in order to remove the touch screen controller cable.
  - b. Unscrew the 2 M4 nuts on the side mounting brackets.
  - c. Separate the LCD monitor
3. Mount the touch screen to the inside surface of your device.
4. Install the monitor on the hooks and reconnect the flex cable to the controller.
5. Touch information is communicated to the computer via an RS-232 connector. Connect the DB-9 connector of the provided RS-232 cable to the RS-232 port on the host computer.
6. Connect the other end to the RS-232 port on the touch controller.
7. The controller requires 300 mA at 5V. from a power source. Connect the provided Molex Microfit Jr. connector to the touch controller, and connect the leads out of the Microfit Jr. connector to a 5V power source.
8. Power on the host computer and install the NFI touch drivers found on the provided CD. Follow instructions to calibrate touch screen.

## Technical Data

- Surface: Anti-glare.
- Optical Clarity: >83% @ 550nm.
- Surface Hardness: Mohs Hardness Rating of 6.
- Response Time: <20ms nominal controller response time.
- Impact Resistance: Meets UL-1950 and CSA C22.2 No.50 ball drop test.
- Interface: RS232 Cable.

For more technical information on 3M touch products, visit [3Mtouch.com](http://3Mtouch.com).

## Capacitive Touch Screen

LC1502R with Capacitive Touch Screen

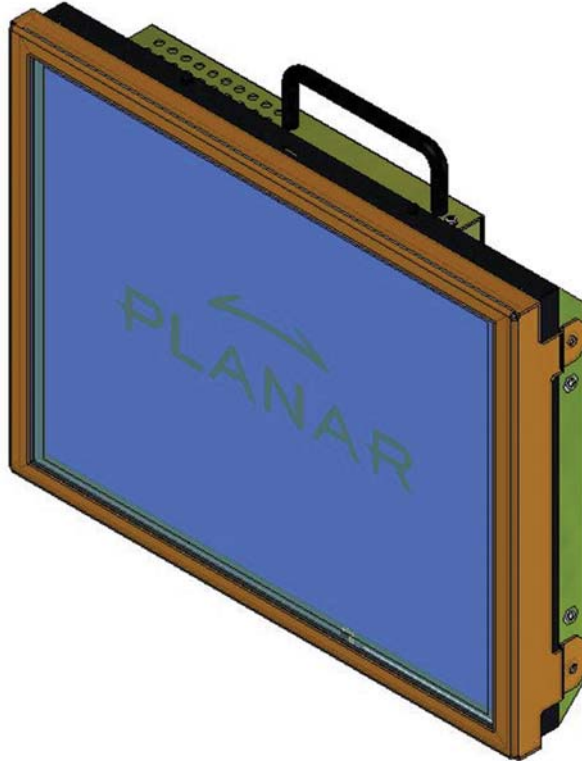

The LC1502R with capacitive touch screen – model LC1502RTC – is designed to be installed in enclosures placed in high ambient lighting environments that are protected from extreme environmental conditions. It utilizes a standard 3M capacitive touch screen.

### Set Up

1. Refer to Planar mechanical outline drawing 076-0587-xx for the mounting hole locations.
2. Connect the USB cable of the touch controller to an available USB port on the host computer.
3. Power on host computer and install the capacitive touch driver found on the provided CD. Follow instructions to calibrate touch screen.

### Technical Data

- Surface: Anti-glare
- Optical Clarity:  $\leq 88\%$  @ 550nm
- Surface Scratch Hardness: Mohs Hardness Rating of 6.5.
- Touch Contact Requirements: 3ms for finger input.
- Interface: USB

For more technical information on 3M touch products, visit [3Mtouch.com](http://3Mtouch.com).



# Appendix

## Troubleshooting

*If you are experiencing trouble with the LCD display, refer to the following. If the problem persists, please contact your local stat or visit Planar Support at [www.Planar.com/support](http://www.Planar.com/support). See support contact information on rear cover. For all video image problems, first try using the Auto-Adjustment in the OSD menu.*

### **Problem: No image appears on screen.**

- Check that all the I/O and power connectors are installed correctly and well connected as described in the " Installation " section.
- Make sure the pins of the connectors are not bent or broken.

### **Problem: Partial image or incorrectly displayed image.**

- Check to see if the resolution of your computer is higher than that of the LCD display.
- Reconfigure the resolution of your computer to make it less than or equal to 1024 x 768

### **Problem: Image has flickering vertical line bars.**

- Use " Frequency " to make an adjustment.
- Check and reconfigure the display mode of the vertical refresh rate of your graphic card to make it compatible with the LCD display.

### **Problem: Image is unstable and flickering**

- Use " Tracking " to make an adjustment.

### **Problem: Image is scrolling**

- Check and make sure the VGA signal cable (or adapter) is well connected.
- Check and reconfigure the display mode of the vertical refresh rate of your graphic card to make it compatible with the LCD display.

### **Problem: Vague image (characters and graphics)**

- Use " Frequency " to make an adjustment. If this problem persists, use "Tracking" to make an adjustment.

## Warning Signal

If you see warning messages on your LCD screen, this means the LCD display cannot receive a clean signal from the computer graphics card. There may be three sources for this problem. Please check the cable connections or contact Planar for more information.

### **No Signal**

This message means the LCD display has been powered on but it cannot receive any signal from the computer graphic card. Check all the power switches, power cables, and VGA signal cable.

**Going to Sleep**

This message means the LCD display is under the power saving mode. In addition, the LCD display will go to this sleeping mode when experiencing a sudden signal disconnecting problem.

**Unsupport Mode**

This message means the signal of the computer graphic card is not compatible with the LCD display. When the signal is not included in the compatibility mode we have listed in the Appendices of this manual, the LCD display will appear this message.

**Out of Range**

This typically means the refresh rate or resolution is set too high. Set the resolution to 1024 x 768 and set the refresh rate to 75 Hz or lower. On a PC, these adjustments are typically made using "Display Properties" in the Control Panel folder.

**Faint Horizontal Dark Lines Across the Screen**

This display is directly backlit by cold cathode fluorescent lamps. Slight brightness nonuniformity is normal.

**Mechanical Outline**

See [mechanical outline drawing on www.planar.com/support](http://www.planar.com/support)

## Description of Warranty

Seller warrants that the Goods will conform to published specifications and be free from defects in material for 12 months from delivery. To the extent that Goods incorporate third-party-owned software, Seller shall pass on Seller's licensor's warranty to Buyer subject to the terms and conditions of Seller's license.

Warranty repairs shall be warranted for the remainder of the original warranty period. Buyer shall report defect claims in writing to Seller immediately upon discovery, and in any event, within the warranty period. Buyer must return Goods to Seller within 30 days of Seller's receipt of a warranty claim notice and only after receiving Seller's Return Goods Authorization. Seller shall, at its sole option, repair or replace the Goods.

If Goods were repaired, altered or modified by persons other than Seller, this warranty is void.

Conditions resulting from normal wear and tear and Buyer's failure to properly store, install, operate, handle or maintain the Goods are not within this warranty. Repair or replacement of Goods is Seller's sole obligation and Buyer's exclusive remedy for all claims of defects. If that remedy is adjudicated insufficient, Seller shall refund Buyer's paid price for the Goods and have no other liability to Buyer.

All warranty repairs must be performed at Seller's authorized service center using parts approved by Seller. Buyer shall pay costs of sending Goods to Seller on a warranty claim and Seller shall pay costs of returning Goods to Buyer. The turnaround time on repairs will usually be 30 working days or less. Seller accepts no added liability for additional days for repair or replacement.

If Seller offers technical support relating to the Goods, such support shall neither modify the warranty nor create an obligation of Seller. Buyer is not relying on Seller's skill or judgment to select Goods for Buyer's purposes. Seller's software, if included with Goods, is sold as is, and this warranty is inapplicable to such software.

SELLER DISCLAIMS ALL OTHER WARRANTIES, EXPRESS OR IMPLIED, INCLUDING BUT NOT LIMITED TO, IMPLIED WARRANTIES OF MERCHANTABILITY AND FITNESS FOR A PARTICULAR PURPOSE.

and also Support and Service should reflect what's below:

## Support and Service

Planar is a U.S. company based in Beaverton, Oregon and Espoo, Finland, with a world-wide sales distribution network. Full application engineering support and service are available to make the integration of Planar displays as simple and quick as possible for our customers.

RMA Procedure: For a Returned Material Authorization number, please contact Planar Systems, Inc. with the model number(s) and serial number(s). When returning goods for repair, please include a brief description of the problem, and mark the outside of the shipping container with the RMA number.

**Planar Systems, Inc.**

Customer Service

**24x7 Online Technical Support:** <http://www.planar.com/support>

**Americas Support**

**Tel:** 1-866-PLANAR1 (866-752-6271)

**Hours:** M-F, 7:30am - 5pm Pacific Time

**Europe and Asia-Pacific Support**

**Tel:** +358-9-420-01

**Hours:** M-F, 7:00am - 4pm CET

© 2004 **Planar Systems, Inc. 09/04** Planar is a registered trademark of Planar Systems, Inc.

Other brands and names are the property of their respective owners.

Technical information in this document is subject to change without notice.

**Document No. 020-0315-00B**

## Free Manuals Download Website

<http://myh66.com>

<http://usermanuals.us>

<http://www.somanuals.com>

<http://www.4manuals.cc>

<http://www.manual-lib.com>

<http://www.404manual.com>

<http://www.luxmanual.com>

<http://aubethermostatmanual.com>

Golf course search by state

<http://golfingnear.com>

Email search by domain

<http://emailbydomain.com>

Auto manuals search

<http://auto.somanuals.com>

TV manuals search

<http://tv.somanuals.com>