



PE1500 LCD Monitor

USER'S GUIDE

www.planar.com

Contents

Introduction	1
Features	1
For Your Safety	1
Installation.....	3
Unpacking the Display	3
Locations and Functions of Controls	3
Making the Connections	4
Using Your Display	5
Turning the Display On and Off	5
Tilting the Display	6
Setting the Video Mode	6
Setting the Refresh Rate	6
Minimizing Power Consumption	7
Caring for and Cleaning the Display	7
Adjusting Your Display	8
Summary of Control Buttons	8
Displaying the OSD “Main Menu”	8
Selecting Items in the OSD Menu	9
Doing Adjustment in the OSD Menu	10
Using the Direct Keys	19
Troubleshooting	21
Technical Information	22
Display Information	22
Video Modes	23
Unknown Video Modes	23
Regulatory information	24
Agency approval	24
FCC statement	24

Introduction

This latest LCD monitor has a 15-inch active matrix TFT (thin film transistor) liquid crystal display module. It is designed for use with any Windows[®]-based PC (adapter may be required for the Macintosh). The monitor's compact-sized design provides great space savings on your desk.

Features

Important features include:

- ⇒ Automatic configuration to the PC video settings with maximum XGA resolution.
- ⇒ Three control buttons plus OSD (on-screen display) for monitor settings adjustment and configuration with ease and instant feedback.
- ⇒ Support analog video input for direct and immediate replacement of CRT displays.
- ⇒ A tilt feature to optimize viewing position.
- ⇒ An anti-glare coating on the panel to reduce the reflection of ambient light.
- ⇒ Flicker-free performance across all recommended video modes.
- ⇒ Support for high refresh rates up to 75 Hz.
- ⇒ VESA DDC2B Plug-and-Display compliant.
- ⇒ VESA mounting interface on stand base.
- ⇒ A Power-saving feature that is compatible with Microsoft[®] Windows
- ⇒ Compliance with Swedish MPR II guidelines for reduced electromagnetic emissions.

For Your Safety

For your safety and the protection of your monitor, follow these precautions:

- ⇒ Use only the factory-supplied power cord that shipped with your monitor.

Warning

To completely disconnect power from your display, you must remove the power cord from the wall outlet and then remove the power cable from the display.

- ⇒ To prevent electrical shock, do not disassemble the display. The cover should be removed only by qualified service personnel.

- ⇒ Do not cover the air vents.
- ⇒ To avoid the risk of damage to the display and electrical shock to yourself, do not expose the display to rain or moisture.

If any of the following conditions occur, unplug the display and contact qualified service personnel:

- ⇒ The power cord or plug is frayed or damaged.
- ⇒ You have spilled liquid into the display.
- ⇒ The display has been exposed to rain or water.
- ⇒ The display does not operate correctly when the operating instructions are followed.
- ⇒ The display has been dropped or the cabinet has been damaged.

*Only for use with supplied adapter, in case of loss or damage replace with HIPRO

TA-02040D432. Contact Planar for details.

Installation

Please follow the instructions in this chapter to install your LCD Monitor.

Note: *Before connecting your display, first read through the instructions in this chapter and the safety precautions in the previous chapter.*

Unpacking the Display

When you are unpacking the display, make sure that you have the following items:

- ⇒ The LCD monitor
- ⇒ AC power adapter with attached power cable
- ⇒ A power cord
- ⇒ Analog video signal cable
- ⇒ The User's Manual

Note: *Place the display on a flat, sturdy surface. Choose an area free from excessive heat, moisture, and sunlight.*

Locations and Functions of Controls

There are three control buttons and one power button on the front panel of the display, as well as a LED for power status indication.

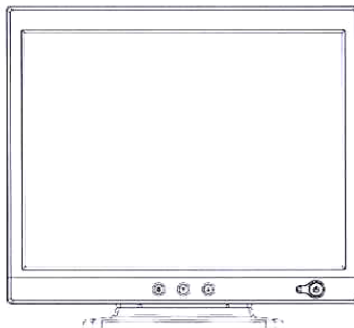

You will use the power button located at the lower right side of the front panel of your display to turn on and off the display.

The functions of the three control buttons which are located at the lower left side of the front panel of your display. Their functions are described as below:

Button	Function Description
Select	(1) Turn on OSD menu while it is off. (2) Execute the function selected in the OSD menu. (3) Hold down for 2 sec will clear OSD menu.
Up (Δ)	(1) Item selection move upward or user-adjustable value increasing. (in Main Menu). (2) Brightness (Direct-key function)
Down (∇)	(1) Item selection move downward, user-adjustable value decreasing (in Main Menu) (2) Auto Setup (Direct-key function).

Making the Connections

Before connecting any cables, make sure that the computer and display are turn off.

To connect the power and video signal cables:

1. Locate the AC power adapter with attached power cable.
2. Connect the power cable to the power jack on the back of the display (as shown below).
3. Plug the two-prong power cord into a power outlet, and plug the other end into the AC power adapter.

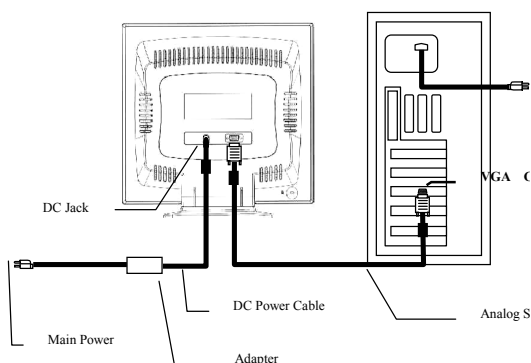

Plug the analog video signal cable into the Analog Video Input port on the back of the display (as shown above).

4. Connect the other end of the video cable into your computer's video port. (Please check your computer's documentation if you're not sure where the port is located.)

Note: For best display performance, it is strongly recommended that you use Auto Setup to automatically configure your display's settings.

Using Your Display

This chapter contains information about using your LCD Monitor.

Turning the Display On and Off

Use the power button located at the lower right side of the front panel of the display to turn the display on and off. When the display is on, the light (LED) near the Power button is illuminated. The light is green when both the display and PC are active and amber when the display is in a reduced power mode.

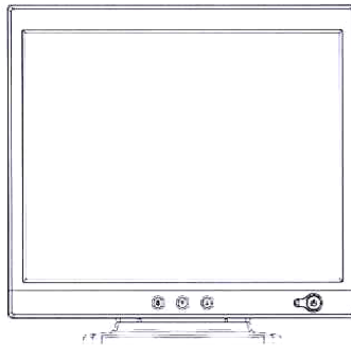

If your PC supplies power saving signals to the display, the display's power management features reduce power consumption to low levels when your PC goes into its power-saving mode. See "Minimizing Power Consumption" on page 7 for more information.

If your PC doesn't use industry standard power-save signaling techniques, you can reduce power consumption by turning off the display when it won't be used for an extended period. You can turn the display off even if you leave your PC in running.

Note: *Because of the technology used in LCD panels, screen savers will not prolong the life of your display. So if the display will not be used for an extended period, be sure to turn it off.*

Warning

To completely disconnect power from your display, you must remove the power cord from the wall outlet and then remove the power cable from the display.

Tilting the Display

The monitors have a tilt feature that allows you to tilt the display back and forth as well as left and right to find the most comfortable viewing position. To tilt the display, grasp the sides and push the display back or pull it toward you, or turn it left or right until it is in the desired position. The display can be tilted 20° backward and 5° forward.

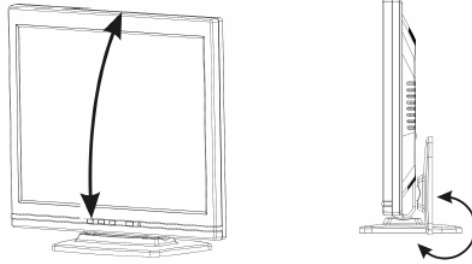

Note: *Do not tilt the display by grasping the top edge.*

Setting the Video Mode

Since the inherent format of this display is 1024 pixels by 768 lines, the display will perform best when your PC is set to a screen resolution of 1024 x 768. If you use a lower resolution (such as 640 x 480), the image is expanded to fill the screen.

Your display supports many common video modes, as shown in “Video Modes” on page 24. Check the documentation supplied with your PC and video adapter card to find out which modes they support.

To see what the video mode in your Microsoft Windows, please check Windows’ settings in your PC.

Setting the Refresh Rate

The image refresh rate is the number of times per second that the image is refreshed; it is also known as the vertical frequency.

On standard CRT displays, we recommend that you should use the highest possible refresh rate supported by your PC at the current screen resolution. This is necessary to avoid screen flickering and to minimize eyestrain. However, with your LCD Monitor, flicker is not an issue. It is flick-free at all supported refresh rates.

The table in “Video Mode” on page 24 shows the image refresh rates supported by the display at different screen resolution. Although your LCD monitor supports up to 75 Hz for analog video input, we recommend that you use **60 Hz** refresh rate for best performance.

To set the refresh rate with a standard Windows installation, follow the steps mentioned in your Windows’s or graphic card’s user’s manual.

Minimizing Power Consumption

Many PCs support industry standard power-save signaling techniques. Power management features reduce the display's power consumption after a period of keyboard inactivity.

When the display is in a power-saving mode, the screen is blank and the power indicator is amber. Pressing a key on the keyboard or moving the mouse restores the image in several seconds. Consult your PC documentation for information about setting the power-saving modes.

The display accepts the signals for the three standard power-saving modes – Standby, Suspend, and Sleep. For any of these conditions, the display will go into Sleep mode.

Caring for and Cleaning the Display

To maximize screen life and prevent damage to the LCD panel, we recommend that you:

- ⇒ Use the display power management system (if available on your PC).
- ⇒ If you don't use a power management system, turn off the display when you won't be using it for an extended period.
- ⇒ Don't press, rub, or poke the display with your finger or other object.
- ⇒ Handle your display with care.

Your LCD module is a high-quality optical device that requires special care when cleaning.

Warning

Don't use liquid, aerosol, or abrasive cleaning solutions to clean the screen.

To clean the screen:

1. Shut down the PC.
2. Turn off and unplug the display.
3. Gently dust the screen with a dry, soft, line-free cloth.

Note: *If the screen is still dirty, you can dampen the cloth with several drops of distilled water. Make sure the LCD panel is completely dry before you turn the display back on.*

4. Plug in the display.
5. Turn on your PC and display.

Adjusting Your Display

This chapter contains information about how to changing display settings for your LCD Monitor. It is designed with an OSD menu to help you easily adjust to its optimum performance.

Note: *You must perform auto setup before making any adjustment.*

Summary of Control Buttons

There are three control buttons located at the lower part of the front panel of your display:

⇒ **Select:** Display the On-Screen Display (OSD) “**Main Menu**”, selects items for user adjustment, and execute the function selected.

Note: *Hold down this key for 2 seconds will clear OSD menu.*

⇒ **Up(Δ):** Move upward through the choice in the OSD submenu. If an adjustment bar is displayed, this button increases the setting value.

Note: *This key is also used as ‘direct key’. When the OSD “Main Menu” is inactive, press this key will execute ‘Brightness’ function.*

⇒ **Down(∇):** Move downward through the choice in the OSD submenu. If an adjustment bar is displayed, this button decreases the setting value.

Note: *This key is also used as ‘direct key’. When the OSD “Main Menu” is inactive, press this key will execute ‘Auto Setup’ function.*

Displaying the OSD “Main Menu”

You can use the OSD features to change the screen settings of your display. To display the OSD “**Main Menu**”, please press the ‘**Select**’ button.

The following table briefly describes each of the items in the OSD “**Main Menu**”.

Item	Description
Auto Setup	Doing the “ Auto Setup ” function. See “Doing Auto Setup” on page 10.
Management	Open the “ Management ” submenu where you can select Brightness, Contrast or the image position for further adjustment. See “Doing Adjustment in the “ Management ” Submenu on page 11.
Clock/Phase	Open the “ Clock/Phase ” submenu where you can select Clock or Phase for further adjustment. See “Doing Adjustment in the “ Clock/Phase ” Submenu” on page 13.
Color	Open the “ Color ” submenu where you can select Color Temperature, RGB and Black Level for further adjustment. See “Doing Adjustment in the “ Color ” Submenu on page 14.
OSD Display	Open the “ OSD Display ” submenu where you can select H. position or V. position of the OSD display for further adjustment. See “Doing Adjustment in the “ OSD Display ” Submenu on page 16.
Factory Recall	Recall factory-setting values back. See “Doing Factory Recall” on page 17.
Language	Open the “ Language ” submenu where you can select one of the five languages for your preference in display OSD messages. See “Selecting Language for Your Preference” on page 18.
Exit	Clear and exit the OSD main menu.

Selecting Items in the OSD Menu

To select items in the OSD “**Main Menu**” , you will use the ‘**Up(Δ)**’ or ‘**Down(∇)**’ buttons on the front panel of the display.

To select items in the OSD submenus, you will use all three control buttons. To select a specific submenu, you shall use ‘**Up(Δ)**’ or ‘**Down(∇)**’ buttons to move forward or backward to the item to be adjusted, and then select it by press ‘**Select**’ button.

Doing Adjustment in the OSD Menu

Doing Auto Setup

To doing the Auto Setup function you should follow the steps below:

1. Bring-up the OSD “**Main Menu**”.
2. The ‘**Auto**’ icon should be highlighted already.

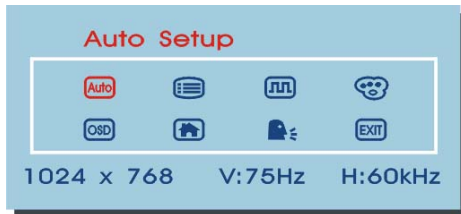

3. Use ‘**Select**’ button to select and execute the Auto Setup function. After the execution of the Auto Setup function, it will show-up the follow message:

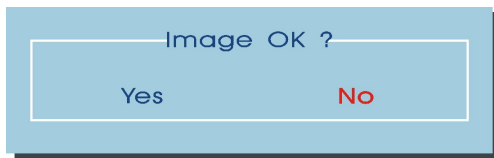

If the image looks correct, choose **Yes**.

OR

If the image requires further adjustment, choose **No**, it will shown up ‘**Phase**’ bar for your further adjustment by manual. Then you can adjust phase by ‘**Up(Δ)**’ or ‘**Down(∇)**’ buttons. When all text appears well focused and there is no instability in the image, press the ‘**Select**’ key to end up the adjustment.

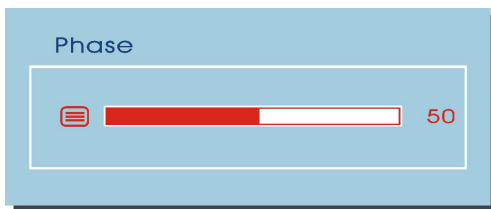

Doing adjustment in the “Management” Submenu

To do adjustment in the “**Management**” submenu you should follow the steps below:

1. Bring-up the OSD “Main Menu”.
2. Use ‘**Up(Δ)**’ (or ‘**Down(∇)**’) to move forward (or backward) to the management icon and highlight it.

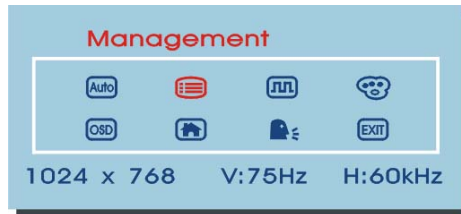

3. Use ‘**Select**’ key to enter the “**Management**” Submenu. It will show up four items for your further adjustment.

If ‘**Brightness**’ is selected, you may use ‘**Up(Δ)**’ or ‘**Down(∇)**’ buttons to adjust the setting of brightness. The fullness of the graphic bar as well as the numerical value at the right corner are also changed accordingly.

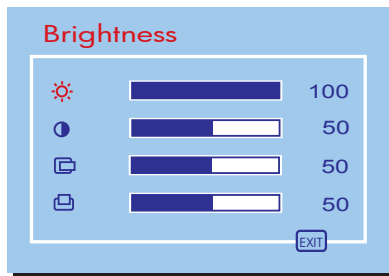

If ‘**Contrast**’ is selected, you may use ‘**Up(Δ)**’ or ‘**Down(∇)**’ buttons to adjust the setting of contrast. The fullness of the graphic bar as well as the numerical value at the right corner are also changed accordingly.

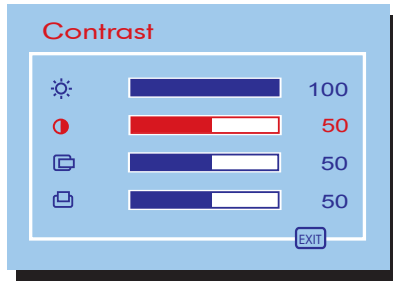

Note: *We recommend you do Auto Setup before adjusting the contrast setting.*

If **'H. position'** is selected, you may use **'Up(Δ)'** or **'Down(▽)'** buttons to adjust the setting of the horizontal position of the image. The fullness of the graphic bar as well as the numerical value at the right corner are also changed accordingly.

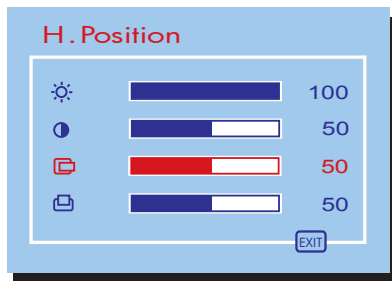

If **'V. position'** is selected, you may use **'Up(Δ)'** or **'Down(▽)'** buttons to adjust the setting of the vertical position of the image. The fullness of the graphic bar as well as the numerical value at the right corner are also changed accordingly.

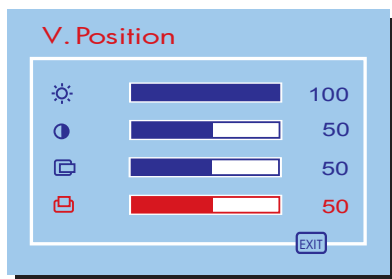

If 'Exit' is selected, it will exit the "Management" submenu and back to the "Main Menu".

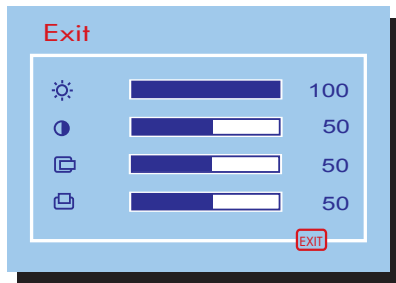

Doing adjustment in the "Clock/Phase" Submenu

To do adjustment in the "Clock/Phase" submenu you should follow the steps below:

1. Bring-up the OSD "Main Menu".
2. Use 'Up(Δ)' (or 'Down(∇)') to move forward (or backward) to the clock/phase icon and highlight it.



3. Use 'Select' key to enter the "Clock/Phase" Submenu. It will show up two items for your further adjustment.

If 'Clock' is selected, you may use 'Up(Δ)' or 'Down(∇)' buttons to adjust the setting of clock. The fullness of the graphic bar as well as the numerical value at the right corner are also changed accordingly.

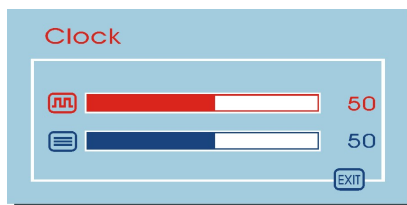

Note: We recommend you do Auto Setup first. And adjusting the clock setting only if the image looks incorrect.

If 'Phase' is selected, you may use 'Up(Δ)' or 'Down(∇)' buttons to adjust the setting of phase. The fullness of the graphic bar as well as the numerical value at the right corner are also changed accordingly.

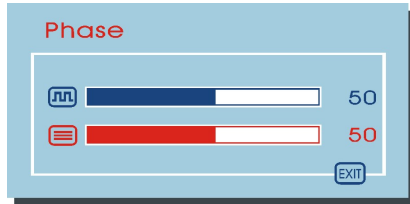

Note: We recommend you do Auto Setup and to see whether the phase needs to adjust or not.

If 'Exit' is selected, it will exit the "Clock/Phase" submenu and back to the "Main Menu".

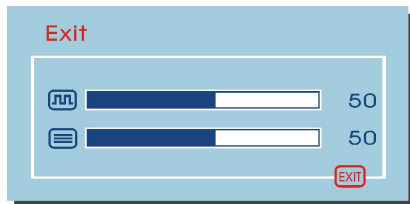

Doing adjustment in the "Color" Submenu

To do adjustment in the "Color" submenu you should follow the steps below:

1. Bring-up the OSD "Main Menu".
2. Use 'Up(Δ)' (or 'Down(∇)') to move forward (or backward) to the color icon and highlight it.



3. Use 'Select' button to enter the "Color" submenu. It will show up three items for your further adjustment.

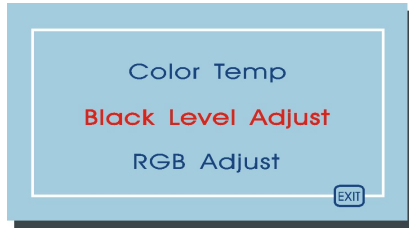

If 'Color Temp' is selected, you may use 'Up(Δ)' or 'Down(∇)' buttons to select one of the three settings. Press 'Select' button will return you back to the "Color" submenu.

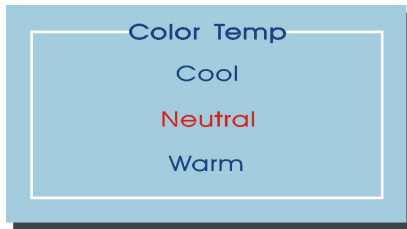

Note: As you choose an item, your screen will immediately updates to reflect this setting.

If 'Black Level Adjust' is selected, it will bring-up "Back Level Adjust" submenu. Use 'Up(Δ)' or 'Down(∇)' buttons to choose and highlight one of the three options (Red, Green and Blue) and then use 'Select' button to select it. This will show-up the corresponding bar on menu, and you can adjust its setting by 'Up(Δ)' and 'Down(∇)' buttons. This control may be helpful in achieving a more natural appearance in graphic images and closer color matching between the printer and the display.

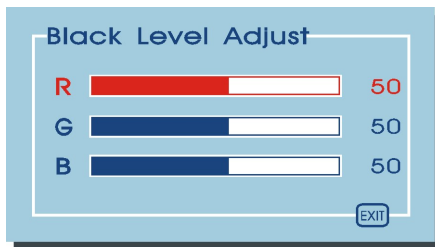

If **'RGB Adjust'** is selected, the same sequence as **'RGB Adjust'** will be followed.

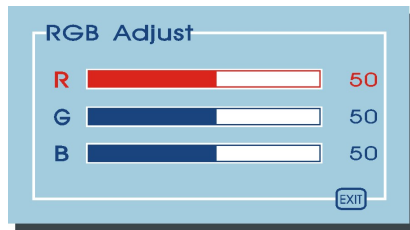

If **'Exit'** is selected, it will exit the **"Color"** submenu and back to the **"Main Menu"**.



Doing Adjustment in the "OSD" submenu

To adjust OSD H. and V. positions you should follow the steps below:

1. Bring-up the OSD **"Main Menu"**.
2. Use **'Up(Δ)'** (or **'Down(∇)'**) to move forward (or backward) to the OSD display icon and highlight it.



3. Use **'Select'** button to enter the **"OSD Display"** submenu. It will show up two items for your further adjustment.

If **'H. Position'** is selected, you may use **'Up(Δ)'** or **'Down(∇)'** buttons to adjust the setting of H. position of the OSD display. The fullness of the graphic bar as well as the numerical value at the right corner are also changed accordingly.

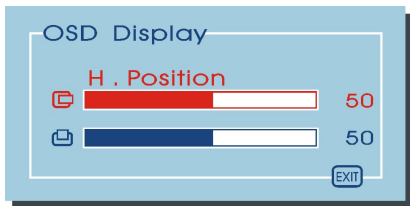

If **'V. Position'** is selected, you may use **'Up(Δ)'** or **'Down(∇)'** buttons to adjust the setting of V. position of the OSD display. The fullness of the graphic bar as well as the numerical value at the right corner are also changed accordingly.

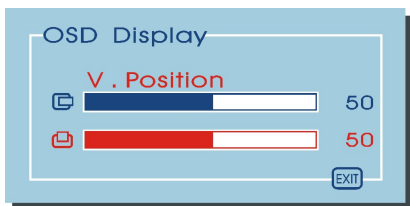

If **'Exit'** is selected, it will exit the **"Clock/Phase"** submenu and back to the **"Main Menu"**.

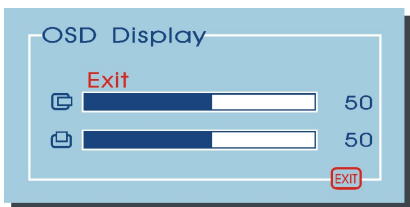

Doing Factory Recall

To recall factory settings back you should follow the steps below:

1. Bring-up the OSD **"Main Menu"**.
2. Use **'Up(Δ)'** (or **'Down(∇)'**) to move forward (or backward) to the factory recall icon and highlight it.



3. Use 'Select' button to activate the factory recall action.

Selecting Language for Your Preference

To select one of the five languages for your preference you should follow the steps below:

1. Bring-up the OSD "Main Menu".
2. Use 'Up(Δ)' (or 'Down(∇)') to move forward (or backward) to the languages icon and highlight it.

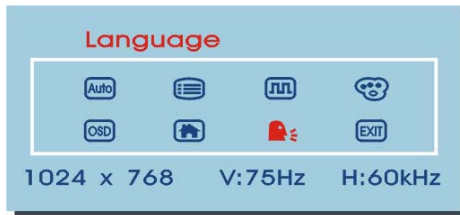

3. Use 'Select' button to enter the "Language" submenu. It will show up five items for your selection. Use 'Up(Δ)' (or 'Down(∇)') to move forward (or backward) to the languages you prefer and Press 'Select' button to select it.



Note: As you choose an item, your OSD information displayed immediately updates to reflect this setting.

Exit and Clear the OSD Menu

To exit and clear the OSD menu you should use ‘Up(Δ)’ (or ‘Down(∇)’) to move forward (or backward) to the exit icon and select it by ‘Select’ button.

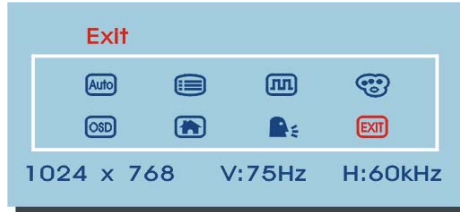

Using the Direct Keys

There are two direct keys that function while OSD “Main Menu” is inactivated. One of the two direct keys is for Auto Setup and the other is for bringing-up OSD “Brightness” menu.

Auto Setup by Direct Key

Use Auto Setup whenever you apply a new video mode or change the refresh rate. While the Auto Setup routine is running, you should have a stable image displayed on the screen. Do not move items around the screen, play games, or view video during Auto Setup.

Once you have executed Auto Setup for a particular mode, the display will store the new values in its permanent memory.

To execute Auto Setup by direct key

1. Press ‘Down (∇)’ button with no OSD “Main Menu” displayed on screen, this will start the execution of Auto Setup.

The image will change color and appear to jitter during the Auto Setup routine running. After the routine is complete, you are asked whether the image appears correct or not.

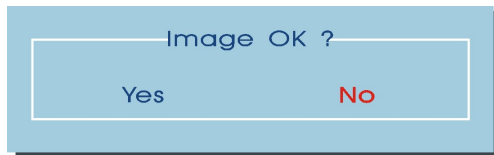

If the image looks correct, choose **Yes**, and then the OSD will close automatically.

OR

If the image requires further adjustment, choose **No**, it will shown up **‘Phase’** bar for your further adjustment by manual. Then you can adjust the phase by **‘Up(Δ)’** or **‘Down(∇)’** buttons. When all text appears well focused and there is no instability in the image, press the **‘Select’** key to end the adjustment and close the OSD menu.

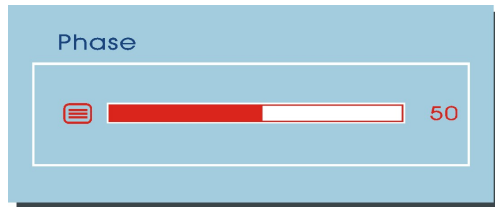

Brightness by Direct Key

To execute Brightness by direct key

Press **‘Up(Δ)’** button with no OSD **“Main Menu”** displayed on screen, this will start the execution of Brightness.

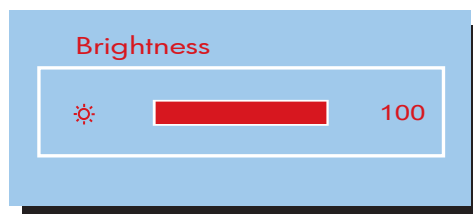

Troubleshooting

This chapter contains information about how to troubleshoot your LCD Monitor. If you have tried all of the items listed below, please contact a qualified service personnel.

A. My display doesn't work, even though the computer appears to work.

1. Make sure the power cable is securely plugged into the display.
2. Make sure the display is turned on.
3. Try turning the display off and then turning it on again.
4. Make sure the display's power cord is plugged into a power outlet and into the AC power adapter. Check to see whether the outlet works by plugging another device (such as a lamp) into the outlet. (If the light on the front of the display is lighted, it is getting power. Try the next item on this procedure.)
5. Check the cable connection between the display and the computer. The cable connectors must be pushed in all the way.

B. The message "Check Cable" appears on my display.

This message appears when the video cable is not properly connected to the computer.

1. Make sure the analog video cable is plugged into the Analog Video Input port on the back of the display.
2. Make sure the other end of analog video cable is plugged into the PC's video port.

C. The message "Signal Out of Range" appears on my display.

This message appears when the input signal is beyond the display's capability.

Set your PC to a supported video mode, preferably 1024 x 768 at 60 Hz. See "Setting the Video Mode" on page .6

D. The image is very unstable.

1. Set your PC to a supported video mode, preferably 1024 x 768 at 60 Hz. See "Setting the Video Mode" on page 6.
2. Restore the original factory settings by choosing **Factory Recall** in the OSD "**Factory Recall**" submenu.
3. Perform the Auto Setup function. See "Auto Setup by Direct Key" on page 19.

Note: *Even if your PC's setting is out of the range of video modes that are supported by your LCD monitor, it may still be displayed with reduced quality. This provides you with an opportunity to change your PC's setting to a correct one.*

Technical Information

This chapter contains technical information about your LCD Monitor.

Display Information

LCD Module	15-in, active matrix TFT, anti-glare coating, 0.297 mm pixel pitch
Display Size	304.1 mm x 228.1 mm
Viewing Angle	
Left/Right	-70° / 70°
Up/Down	-65° / 60°
Display Colors	262144
Power Input	100 ~ 240 V _{AC} Full Range, 50/60 Hz (External AC adapter)
Power consumption	Operation Mode : 30W max Off Mode : 2W max
Signal Input	
Video Signal	RGB positive 0.7V _{pp} , 75ohm
Sync signals	Separate & Composite, TTL Level
Line (horizontal) frequency	31.5 kHz ~ 60 kHz
Raster (vertical) frequency	56 Hz ~ 75 Hz
Pixel dot clock	80 MHz (maximum)
Recommended mode	1024 x 768 @ 60 Hz
Pedestal tilt	20° forward, 5°backward
Dimensions (W x H x D)	341mm x 317mm x 140mm 341mm x 338mm x68mm (pedestal fold)
Net Weight	3.0 kg
Gross Weight	4.5 kg
Operating Conditions	
Temperature	5° ~ 40°C at altitude 0 ~ 2000m 5° ~ 30°C at altitude 2000 ~ 3000m
Humidity	20% ~ 85% RH, non-condensing
Altitude	3000m Max.
Storage Conditions	
Temperature	-20° ~ 60°C
Humidity	5% ~ 95% RH
Altitude	10000m Max.

Video Modes

Your LCD monitor supports the following industry-standard combinations of screen resolution and refresh rates. Other combinations are possible, but may require adjustments to the image.

For optimum performance, set your PC to a screen resolution of 1024 x 768 at a 60 Hz refresh rate.

Supported Resolution (dots x lines)		Vertical Frequency (Refresh Rate)
VGA	640 x 350	70 Hz
	640 x 480	60 Hz
	640 x 480	70 Hz
	640 x 480	72 Hz
	640 x 480	75 Hz
SVGA	800 x 600	56 Hz
	800 x 600	60 Hz
	800 x 600	70 Hz
	800 x 600	72 Hz
	800 x 600	75 Hz
XGA	1024 x 768	60 Hz
	1024 x 768	70 Hz
	1024 x 768	72 Hz
	1024 x 768	75 Hz
US TEXT	720 x 400	70 Hz
Power MAC	640 x 480	67 Hz
	832 x 624	75 Hz

Note: *The display is capable of going beyond these recommended modes.*

Unknown Video Modes

Like all other monitors, your LCD monitor is designed to work with standard video modes. However, not all video/graphic cards use only standard display modes.

Your LCD monitor uses state-of-the-art technology, which is designed to synchronize to any display mode. We recommend choosing one of the supported modes listed above. If you choose an unknown mode, you will need to manually adjust the clock, phase, and image position.

If you must use an unknown mode, you can run Auto Setup at first. If Auto Setup doesn't provide adequate image adjustment, then you must manually adjust the clock, phase, horizontal position, and vertical position.

Regulatory Information

Agency Approvals

	<u>European</u>	<u>USA</u>	<u>Japan</u>	<u>Others</u>
	CE Mark			
Safety	EN60950 TUV-GS	UL1950		CSA950 BSMI
Emissions	EN50081-1	FCC Class B	VCCI	
Immunity	EN50082-1			
Ergonomic	ISO9241-3			
VLMF	MPR II			
TCO99	TCO model only			

FCC Statement: FCC Notice – Part 15

This device complies with Part 15 of FCC rules. Operation is subject to the following two conditions:

- (1) This device may not cause harmful interference.
- (2) This device must accept any interference received. Including interference that may cause undesired operation.

Planar Systems, Inc.

Customer Service

Online Support : <http://planar.custhelp.com>

Email : desktopmonitors@planar.com

Tel : 1-866-PLANAR-1 (1-866-752-6271)

Hours : m-f, 8am-9pm, Eastern Time

©2005 Planar Systems, Inc. 12/03 Planar is a registered trademark of Planar Systems, Inc.

Other brands and names are the property of their respective owners.

Technical information in this document is subject to change without notice.

07/2004

P/N:5030053016C

Free Manuals Download Website

<http://myh66.com>

<http://usermanuals.us>

<http://www.somanuals.com>

<http://www.4manuals.cc>

<http://www.manual-lib.com>

<http://www.404manual.com>

<http://www.luxmanual.com>

<http://aubethermostatmanual.com>

Golf course search by state

<http://golfingnear.com>

Email search by domain

<http://emailbydomain.com>

Auto manuals search

<http://auto.somanuals.com>

TV manuals search

<http://tv.somanuals.com>