



PE1900

User's Manual

Contents

Introduction	2
Features	2
Safety Precautions.....	2
Installation.....	4
Unpacking the Display.....	4
Locations and Functions of Controls	4
Connections	5
Using Your Display	7
Turning the Display On and Off	7
Tilting the Display	8
Setting the Video Mode	8
Setting the Refresh Rate	8
Minimizing Power Consumption.....	9
Caring for and Cleaning the Display.....	9
Adjusting Your Display.....	11
Summary of Control Buttons.....	11
Displaying the OSD “Main Menu”.....	11
Selecting Items in the OSD Menu	12
Adjusting the OSD Menu.....	12
Using the Direct Keys.....	22
Troubleshooting.....	24
Technical Information	26
Display Information	26
Video Modes	27
Unknown Video Modes.....	27
Regulatory Information.....	28
Agency Approval	28
FCC Statement	28

Introduction

The PE1900 LCD monitor has a 19-inch active matrix TFT (thin film transistor) liquid crystal display module. It is designed for use with any Windows®-based PC.

Features

- ⇒ Automatic configuration to the PC video settings with maximum SXGA resolution.
- ⇒ Three control buttons plus OSD (on-screen display) for monitor settings adjustment and configuration with ease and instant feedback.
- ⇒ Support analog video input for direct and immediate replacement of CRT displays.
- ⇒ A tilt feature to optimize viewing position.
- ⇒ Flicker-free performance across all recommended video modes.
- ⇒ Support for high refresh rates up to 75 Hz.
- ⇒ VESA DDC2B Plug-and-Display compliant.
- ⇒ A Power-saving feature that is compatible with Microsoft® Windows

For Your Safety

Warning

To completely disconnect power from your display, you must remove the power cord from the wall outlet and then remove the power cable from the display.

For your safety and the protection of your monitor, follow these precautions:

- ⇒ Use only the factory-supplied power cord that shipped with your monitor.
- ⇒ To prevent electrical shock, do not disassemble the display. The cover should be removed only by qualified service personnel.
- ⇒ Do not cover the air vents.
- ⇒ To avoid the risk of damage to the display and electrical shock to yourself, do not expose the display to rain or moisture.

If any of the following conditions occur, unplug the display and contact qualified service personnel:

- ⇒ The power cord or plug is frayed or damaged.
- ⇒ You have spilled liquid into the display.
- ⇒ The display has been exposed to rain or water.
- ⇒ The display does not operate correctly when the operating instructions are followed.
- ⇒ The display has been dropped or the cabinet has been damaged.

*Only for use with supplied adapter, in case of loss or damage contact Planar for replacement details

*European countries use only with certified power cord 3G , 0.75 mm² , H05 VV-F

Installation

Please follow the instructions in this chapter to install your LCD Monitor.

Note: *Before connecting your display, first read through the instructions in this chapter and the safety precautions in the previous chapter.*

Unpacking the Display

When you are unpacking the display, make sure that you have the following items:

- ⇒ The LCD monitor
- ⇒ AC power adapter with attached power cable
- ⇒ A power cord
- ⇒ Analog video signal cable
- ⇒ User's Manual
- ⇒ Planar Landing strip
- ⇒ Planar Connection CD-ROM

Note: *Place the display on a flat, sturdy surface. Choose an area free from excessive heat, moisture, and sunlight.*

Locations and Functions of Controls

There are three control buttons and one power button on the front panel of the display, as well as a LED for power status indication.

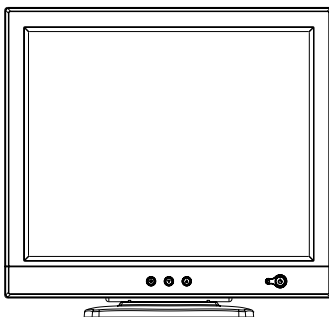

You will use the power button located at the lower right side of the front panel of your display to turn on and off the display.

The functions of the three control buttons which are located at the lower left side of the front panel of your display are described as below:

Button	Function Description
Select	(1) Turn on OSD menu while it is off. (2) Execute the function selected in the OSD menu. (3) Hold down for 3 sec will clear OSD menu
Up (Δ)	(1) Move item selection upward or increase user-adjustable value.(in Main Menu) (2) Activate Brightness Menu (Direct-key function).
Down (∇)	(1) Move item selection downward or reduce user-adjustable value (in Main Menu) (2) Auto Setup (Direct-key function).

Making the Connections

Before connecting any cables, make sure that the computer and display are turned off.

To connect the power and video signal cables:

1. Locate the AC power adapter with attached power cable.
2. Connect the power cable to the power jack on the back of the display (as shown below).
3. Plug the two-prong power cord into a power outlet, and plug the other end into the AC power adapter.

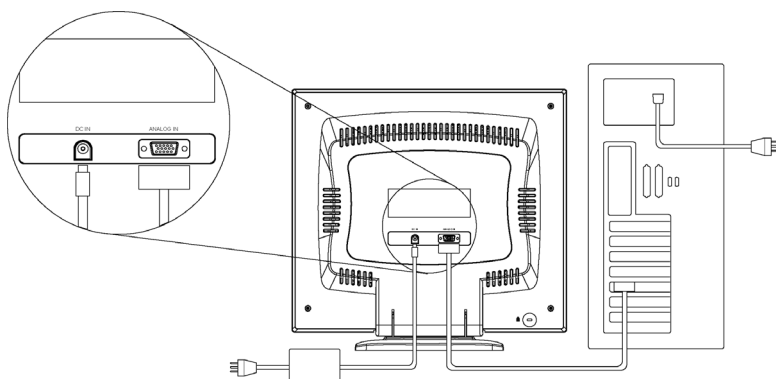

4. Plug the analog video signal cable into the Analog Video Input port on the back of the display (as shown above).
5. Connect the other end of the video cable into your computer's video port. (Please check your computer's documentation if you're not sure where the port is located.)

Note: *For best display performance, it is strongly recommended that you use Auto Setup to automatically configure your display's settings.*

Using Your Display

This chapter contains information about using your LCD Monitor.

Turning the Display On and Off

Use the power button located at the lower right side of the front panel of the display to turn the display on and off. When the display is on, the light (LED) near the Power button is illuminated. The light is green when both the display and PC are active and amber when the display is in power-saving mode.

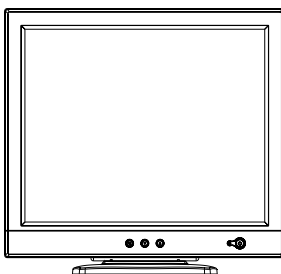

If your PC supplies power saving signals to the display, the display's power management features reduce power consumption to low levels when your PC goes into its power-saving mode. See "Minimizing Power Consumption" on page 9 for more information.

If your PC doesn't use industry standard power-saving techniques, you can reduce power consumption by turning off the display when it won't be used for an extended period. You can turn the display off even if you leave your PC in running.

Note:

Because of the technology used in LCD panels, screen savers will not prolong the life of your display. Be sure to turn off the display if it will not be used for an extended period.

Warning

To completely disconnect power from your display, you must remove the power cord from the wall outlet and then remove the power cable from the display.

Tilting the Display

The monitors have a tilt feature that allows you to tilt the display back and forth to find the most comfortable viewing position. To tilt the display, grasp the sides and push the display back or pull it toward you, or turn it left or right until it is in the desired position. The display can be tilted 20° backward and 5° forward.

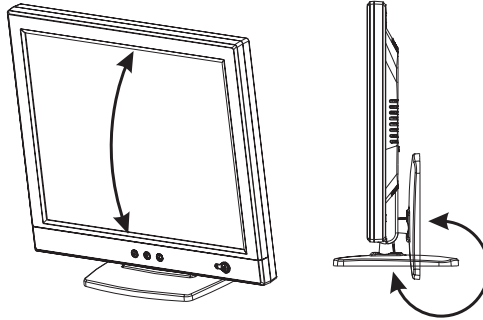

Note: *Do not tilt the display by grasping the top edge.*

Setting the Video Mode

Since the inherent format of this display is 1280 pixels by 1024 lines, the display will perform best when your PC is set to a screen resolution of 1280 x 1024. If you use a lower resolution (such as 640 x 480), the image is expanded to fill the screen.

Your display supports many common video modes, as shown in “Video Modes” on page 27. Check the documentation supplied with your PC and video adapter card to find out which modes they support.

To see what the video mode in your Microsoft Windows, please check Windows’ settings in your PC.

Setting the Refresh Rate

The image *refresh rate* is the number of times per second that the image is refreshed; it is also known as the *vertical frequency*.

On standard CRT displays, you should use the highest possible refresh rate supported by your PC at the current screen resolution. This is necessary to avoid screen flickering and to minimize eyestrain. However, with your LCD Monitor, flicker is not an issue. It is flick-free at all supported refresh rates.

The table in “Video Mode” on page 27 shows the image refresh rates supported by the display at different screen resolution. Although your LCD monitor supports up to 75 Hz for analog video input, we recommend that you use **60 Hz** refresh rate for best performance.

To set the refresh rate with a standard Windows installation, follow the steps mentioned in your Windows or graphic card user’s manual.

Minimizing Power Consumption

Many PCs support industry standard power-saving techniques. Power management features reduce the display’s power consumption after a period of keyboard and mouse inactivity.

When the display is in a power-saving mode, the screen is blank and the power indicator is amber. Pressing a key on the keyboard or moving the mouse restores the image in several seconds. Consult your PC documentation for information about setting the power-saving modes.

The display accepts the signals for standard power-saving mode: When the PC goes into power saving mode, the display will also go into power-saving mode.

Caring for and Cleaning the Display

To maximize screen life and prevent damage to the LCD panel, we recommend that you:

- ⇒ Use the display power management system (if available on your PC).
- ⇒ If you don’t use a power management system, turn off the display when you won’t be using it for an extended period.
- ⇒ Don’t press, rub, or poke the display with your finger or other object.
- ⇒ Handle your display with care.

Your LCD module is a high-quality optical device that requires special care when cleaning.

Warning

Don’t use liquid, aerosol, or abrasive cleaning solutions to clean the screen.

To clean the screen:

1. Shut down the PC.
2. Turn off and unplug the display.
3. Gently dust the screen with a dry, soft, line-free cloth.

Note: *If the screen is still dirty, you can dampen the cloth with several drops of distilled water. Make sure the LCD panel is completely dry before you turn the display back on.*

4. Plug in the display.
5. Turn on your PC and display.

Adjusting Your Display

This chapter contains information about how to change display settings for your LCD Monitor. It is designed with an OSD menu to help you easily adjust to its optimum performance.

Note: *You must perform auto-setup before making any adjustments.*

Summary of Control Buttons

There are four control buttons located at the lower part of the front panel of your display:

- ⇒ **POWER:** Push to turn on or turn off the display. The power indicator (Green) will light while the display is on.
- ⇒ **Select:** Display the On-Screen Display (OSD) “**Main Menu**”, selects items for user adjustment, and execute the function selected.

Note: *Hold down this key for 3 seconds to clear the OSD menu.*

- ⇒ **Up(Δ):** Move upward through the choice in the OSD submenu. If an adjustment bar is displayed, this button increases the setting value.

Note: *This key is also used as a ‘direct key’ to activate the “Brightness Adjust” feature.*

- ⇒ **Down(∇):** Move downward through the choice in the OSD submenu. If an adjustment bar is displayed, this button decreases the setting value.

Note: *This key is also used as a ‘direct key’. When the OSD “Main Menu” is inactive, pressing this key will execute ‘Auto Setup’ function.*

Displaying the OSD “Main Menu”

You can use the OSD features to change the screen settings of your display. To display the OSD “**Main Menu**”, press the ‘**Select**’ button.

The following table briefly describes each of the items in the OSD “**Main Menu**”.

Item	Description
Auto	Adjust the “Auto Setup”. See “Adjusting Auto Setup” on page 12.
Management	Open the “ Management ” submenu to select Brightness, Contrast or Image Position for further adjustment. See Adjustment in the “Management” Submenu on page 13.
Clock/Phase	Open the “ Clock/Phase ” submenu to select Clock or Phase for further adjustment. See Adjustment in the “Clock/Phase” Submenu on page 16.
Color	Open the “ Color ” submenu where you can select Color Temperature, RGB and Black Level for further adjustment. See Adjustment in the “Color” Submenu on page 17.
OSD Display	Open the “ OSD Display ” submenu to select Horizontal or Vertical position in the OSD display for further adjustment. See Adjustment in the “OSD Display” Submenu on page 19.
Factory Recall	Recall the original factory-setting values. See “Factory Recall” on page 20.
Languages	Open the “ Languages ” submenu where you can select one of the five languages for your preference in display OSD messages. See “Selecting your preferred Language” on page 21.
Exit	Clear and exit the OSD main menu.

Selecting Items in the OSD Menu

To select items in the OSD “**Main Menu**”, you will use the ‘**Up** (Δ)’ or ‘**Down** (∇)’ buttons on the front panel of the display.

To select items in the OSD submenus, you will use all three control buttons. To select a specific submenu, use ‘**Up** (Δ)’ or ‘**Down** (∇)’ buttons to move forward or backward to the item to be adjusted, and then select by pressing the ‘**Select**’ button.

Adjusting the OSD Menu

Auto Setup

To perform the Auto Setup function you should follow the steps below:

1. Bring-up the OSD “**Main Menu**”.
2. The ‘Auto’ icon will be highlighted.



3. Use '**Select**' button to select and execute the Auto Setup function. After the execution of the Auto Setup function, it will show the following message:

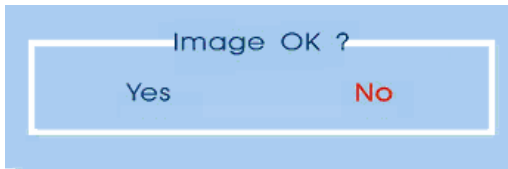

If the image looks correct, choose '**Yes**'.

OR

If the image requires further adjustment, choose **No**. This will activate the 'Phase' bar for further manual adjustment. Adjust the phase using the '**Up** (Δ)' or '**Down** (∇)' buttons. When all text appears well focused and the image is stable, press the '**Select**' key to finalize the adjustment.

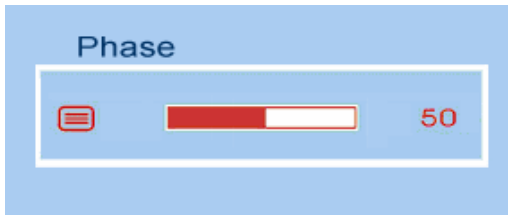

Adjusting the "Management" Submenu

Follow the steps below to adjust settings in the "Management" submenu:

1. Activate the OSD "**Main Menu**".
2. Use '**Up** (Δ)' (or '**Down** (∇)') to move forward (or backward) to the management icon and highlight it.



- Use 'Select' key to enter the "Management" Submenu. This activates four items for adjustment.

If 'Brightness' is selected, use 'Up (Δ)' or 'Down (∇)' buttons to adjust the setting of brightness. The graphic bar and numerical value at the right corner responds accordingly.

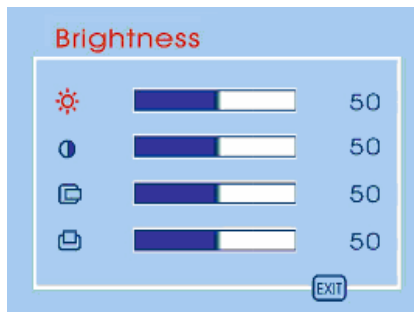

If 'Contrast' is selected, use 'Up (Δ)' or 'Down (∇)' buttons to adjust the setting of contrast. The graphic bar and numerical value at the right corner responds accordingly.

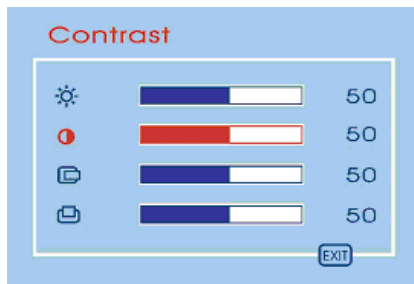

Note: We recommend performing the Auto-Setup before adjusting the contrast setting.

If 'H. position' is selected, use 'Up (Δ)' or 'Down (∇)' buttons to adjust the setting of the horizontal position of the image. The graphic bar and numerical value at the right corner

responds accordingly.



If 'V. position' is selected, use 'Up (Δ)' or 'Down (∇)' buttons to adjust the setting of the vertical position of the image. The graphic bar and numerical value at the right corner responds accordingly.



Select 'Exit' to exit the "Management" submenu and return to the "Main Menu".



Adjusting the “Clock/Phase” Submenu

Follow the steps below to adjust the “Clock/Phase” submenu:

1. Activate the OSD “**Main Menu**”.
2. Use ‘Up (Δ)’ (or ‘Down (∇)’ to move forward (or backward) to the clock/phase icon and highlight it.



3. If ‘Clock’ is selected, use ‘Up (Δ)’ or ‘Down (∇)’ buttons to adjust the setting of clock. The graphic bar and numerical value at the right corner responds accordingly.

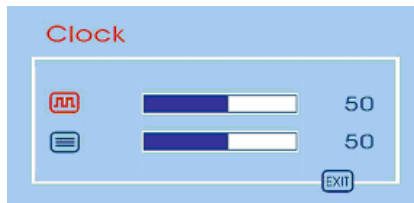

Note: *We recommend performing the Auto-Setup first. Adjust the clock setting only if the image looks incorrect.*

If ‘Phase’ is selected, use ‘Up (Δ)’ or ‘Down (∇)’ buttons to adjust the setting of phase. The graphic bar and numerical value at the right corner responds accordingly.

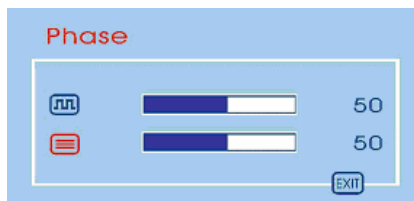

Note: *We recommend performing the Auto-Adjust before adjusting the phase.*

Select ‘Exit’ to exit the “Clock / Phase” submenu and return to the “Main Menu”.

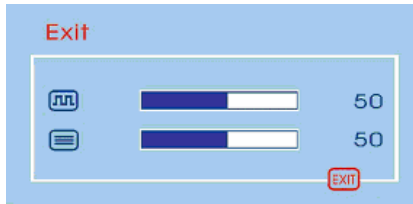

Adjusting the “Color” Submenu

Follow the steps below to adjust the “Color” submenu:

Activate the OSD “**Main Menu**”.

1. Use ‘**Up** (Δ)’ (or ‘**Down** (∇)’) to move forward (or backward) to the color icon and highlight it.

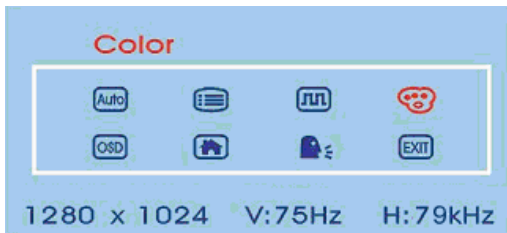

2. Use ‘**Select**’ button to enter the “Color” submenu. This activates three items for further adjustment.



If ‘Color Temp’ is selected, use ‘**Up** (Δ)’ or ‘**Down** (∇)’ buttons to select one of the three settings. Press ‘**Select**’ to return to the “Color” submenu.

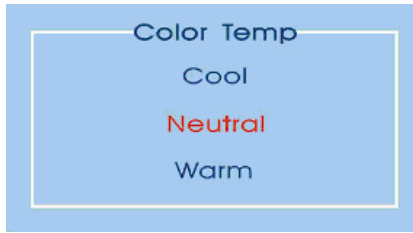

Note: As you choose an item, your screen immediately updates to reflect this setting.

Selecting 'Black Level Adjust' activates the "Black Level Adjust" submenu. Adjust its setting by using the 'Up (Δ)' and 'Down (∇)' buttons.

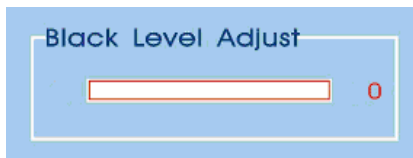

If 'RGB Adjust' is selected, the "RGB Adjust" submenu is activated. Use the 'Up (Δ)' or 'Down (∇)' buttons to choose and highlight one of the three options (Red, Green and Blue) and then use 'Select' button to select it. This will activate the corresponding bar on menu, and is adjusted using the 'Up (Δ)' and 'Down (∇)' buttons. This control may be helpful in achieving a more natural appearance in graphic images and closer color matching between the printer and the display.

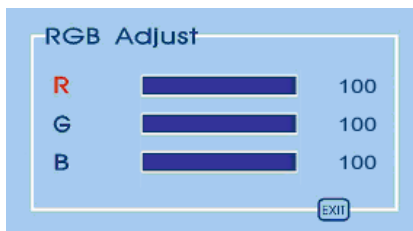

Select 'Exit' to exit the "Color" submenu and return to the "Main Menu".



Adjusting the “OSD Display” submenu

Follow the steps below to adjust the OSD Horizontal and Vertical positions:

1. Activate the OSD “**Main Menu**”.
2. Use ‘**Up** (Δ)’ or ‘**Down** (∇)’ to move forward (or backward) to the OSD display icon and highlight it.



3. Use ‘**Select**’ button to enter the “OSD Display” submenu. This activates two items for further adjustment.

If ‘H. Position’ is selected, use the ‘**Up** (Δ)’ or ‘**Down** (∇)’ buttons to adjust the setting of Horizontal position of the OSD display. The graphic bar and numerical value at the right corner responds accordingly.

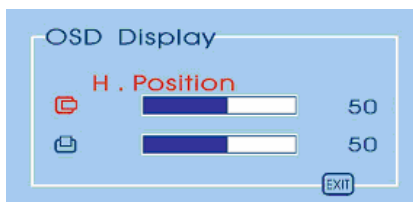

If ‘V. Position’ is selected, use the ‘**Up** (Δ)’ or ‘**Down** (∇)’ buttons to adjust the setting of V. position of the OSD display. The graphic bar and numerical value at the right corner responds accordingly.

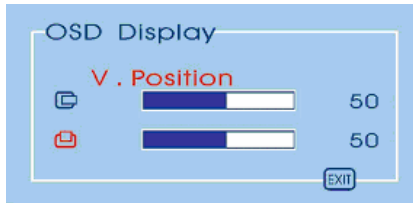

Select 'Exit' to exit the "OSD Display" submenu and return to the "Main Menu".

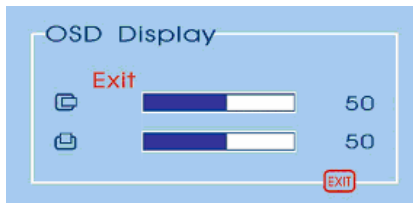

Adjusting the Factory Recall

To recall factory settings back you should follow the steps below:

1. Activate the OSD "Main Menu".
2. Use 'Up (Δ)' (or 'Down (∇)') to move forward (or backward) to the factory recall icon and highlight it.

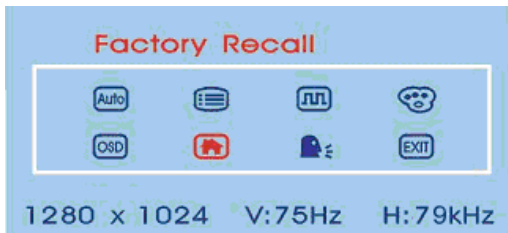

3. Use 'Select' button to activate the factory recall action.

Selecting your preferred Language

Follow the steps below to select one of the five languages:

1. Activate the OSD “**Main Menu**”.
2. Use ‘**Up** (Δ)’ (or ‘**Down** (∇)’) to move forward (or backward) to the languages icon and highlight it.

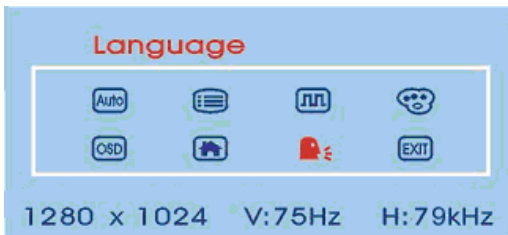

3. Use the ‘**Select**’ button to enter the “Language” submenu. This activates five items for selection. Use the ‘**Up** (Δ)’ (or ‘**Down** (∇)’) to move forward (or backward) to the language you prefer and press ‘**Select**.’



Note: *As you choose an item, your OSD information displayed immediately updates to reflect this setting.*

Exit and Clear the OSD Menu

Use the ‘**Up** (Δ)’ (or ‘**Down** (∇)’) to move forward (or backward) to the exit icon and select it by choosing the ‘**Select**’ button.

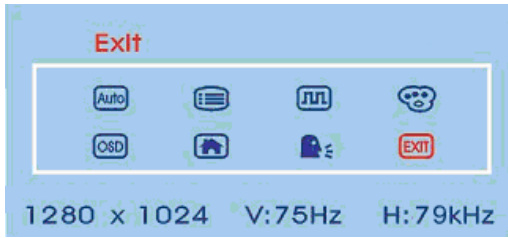

Using the Direct Keys

There are two direct keys that function while OSD “**Main Menu**” is inactivated: “Auto-Setup” and “**Brightness.**”

Using the “Auto Setup” Direct Key

Use Auto-Setup whenever you apply a new video mode or change the refresh rate. While the Auto-Setup routine is running, ensure a stable image is displayed on the screen. Do not move items around the screen, play games, or view video during Auto-Setup.

Once you have executed Auto Setup for a particular mode, the display will store the new values in its permanent memory.

To execute Auto Setup by direct key

1. Press ‘**Down (▽)**’ button with no OSD “**Main Menu**” displayed on screen, this will start the execution of Auto Setup.

The image will change color and appear to jitter during the Auto Setup function. After the function is complete, you are asked whether the image appears correct or not.

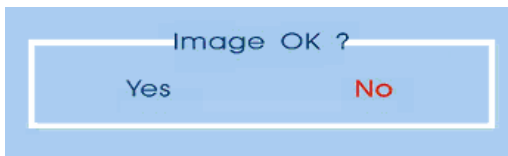

2. If the image looks correct, choose ‘**Yes**’, and then the OSD will close automatically.

If the image requires further adjustment, choose **No**, and the 'Phase' bar is activated for further manual adjustment. Adjust the phase using 'Up (Δ)' or 'Down (∇)' buttons. When all text appears well-focused and the image is stable, press the 'Select' key to end the adjustment and close the OSD menu.

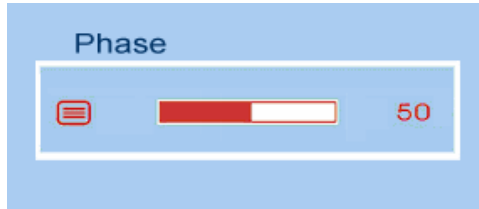

Troubleshooting

This chapter contains information about how to troubleshoot your LCD Monitor. If you have tried all of the items listed below, please contact qualified service personnel.

A. My display doesn't work, even though the computer appears to work.

1. Make sure the power cable is securely plugged into the display.
2. Make sure the display is turned on.
3. Try turning the display off and then turning it on again.
4. Make sure the display's power cord is plugged into a power outlet and into the AC power adapter. Check to see whether the outlet works by plugging another device (such as a lamp) into the outlet. (If the light on the front of the display is lighted, it is getting power. Try the next item on this procedure.)
5. Check the cable connection between the display and the computer. The cable connectors must be pushed in all the way.

B. The message "Check Cable" appears on my display.

This message appears when the video cable is not properly connected to the computer.

1. Make sure the analog video cable is plugged into the Analog Video Input port on the back of the display.
2. Make sure the other end of analog video cable is plugged into the PC's video port.

C. The message "No Sync" appears on my display.

This message appears when there is no video signal from the computer with cable already connected.

1. Make sure that the computer's power is turned on.
2. Make sure that your graphic card is appropriately set-up.

D. The message "Signal Out Of Range" appears on my display.

This message appears when the input signal is beyond the display's capability.

Set your PC to a supported video mode, preferably 1280 x 1024 at 60 Hz. See "Setting the Video Mode" on page 8.

E. The image is very unstable.

1. Set your PC to a supported video mode, preferably 1280 x 1024 at 60 Hz. See “Setting the Video Mode” on page 8.
2. Restore the original factory settings by choosing **Factory Recall** in the OSD “**Factory Recall**” submenu.
3. Perform the Auto Setup function. See “Auto Setup by Direct Key” on page 22.

Note: *Even if your PC's setting is out of the range of video modes that are supported by your LCD monitor, it may still be displayed with reduced quality. This provides you with an opportunity to change your PC's setting to a correct one.*

Technical Information

This chapter contains technical information about your LCD Monitor.

Display Information

LCD Module	19-in, active matrix TFT, anti-glare coating, 0.294 mm pixel pitch.
Display Size	14.8 (H) x 11.9 (V) inches.
Viewing Angle	
Left / Right	-85° / 85°(Typical).
Up / Down	-85° / 85°(Typical).
Display Colors	16.7 million.
Power Input	100 ~ 240 V _{ac} , 1.2A. Full Range, 50/60 Hz (External AC adapter).
Maximum/ Standby power consumption	< 35 / 3. Watts
Signal Input	
Video Signal	RGB positive 0.7V _{pp} , 75ohm.
Sync signals	Separate & Composite, TTL Level.
Line (horizontal) frequency	31.5 kHz ~ 80 kHz.
Raster (vertical) frequency	56 Hz ~ 75 Hz.
Pixel dot clock	135 MHz (maximum).
Recommended mode	1280 x 1024 @ 60 Hz.
Pedestal tilt	-5° forward, 20° backward.
Dimensions (W x H x D)	without stand : 17.4(W) x 2.2 (D) x 15.4 (H) inches. with stand : 17.4(W) x 7.9 (D) x 16.4 (H) inches.
Weight	14.1 pounds
Operating Conditions	
Temperature	5° ~ 40°C at altitude 0 ~ 6500 feet 5° ~ 30°C at altitude 6500 ~ 10000 feet
Humidity	20% ~ 85% RH, non-condensing
Storage Conditions	
Temperature	-20° ~ 60°C
Humidity	5% ~ 95% RH
Altitude	33000 feet Max.

Video Modes

Your LCD monitor supports the following industry-standard combinations of screen resolution and refresh rates. Other combinations are possible, but may require adjustments to the image.

For optimum performance, set your PC to a screen resolution of 1280 x 1024 at a 60 Hz refresh rate.

Display Mode	Mode No.	H. sync. (Hz)	V. sync. (Hz)	Dot Frequency (Hz)
VGA 640 x 350 640 x 480 640 x 480 640 x 480.	1	31.5k	70	25.175M
	2	31.5k	60	25.175M
	3	37.9k	72	31.5M
	4	37.5k	75	31.5M
SVGA 800 x 600	5	35.1k	56	36.0M
	6	37.9k	60	40.0M
	7	48.1k	72	50.0M
	8	46.9k	75	49.5M
XGA 1024 x 768	9	48.4 k	60	65.0 M
	10	56.5k	70	75.0M
	11	60.0k	75	78.75M
SXGA 1280 x 1024	12	63.981k	60	108M
	13	79.976k	75	135M
US TEXT 720 x 400.	14	31.5 k	70	28.3 M
POWER MAC 640 x 480 832 x 624.	15	35.0k	67	30.5M
	16	49.7k	75	57.3M

Note: *The display is capable of going beyond these recommended modes.*

Unknown Video Modes

Like all other monitors, your LCD monitor is designed to work with standard video modes. However, not all video/graphic cards use only standard display modes.

Your LCD monitor uses state-of-the-art technology, which is designed to synchronize to any display mode. We recommend choosing one of the supported modes listed above. If you choose an unknown mode, you will need to manually adjust the clock, phase, and image position.

If you must use an unknown mode, run the Auto-Setup first. If Auto-Setup doesn't provide adequate image adjustment, then the clock, phase, horizontal position, and vertical position must be adjusted manually.

Regulatory Information

Agency Approvals

	<u>European</u>	<u>USA</u>	<u>Japan</u>	<u>Others</u>
	CE	UL		
Safety		CSA		
Emissions		FCC Class B .DOC		
Immunity				
Ergonomic				
EPA				YES

FCC Statement: FCC Notice – Part 15

This device complies with Part 15 of FCC rules. Operation is subject to the following two conditions:

- (1) This device may not cause harmful interference.
- (2) This device must accept any interference received. Including interference that may cause undesired operation.

PLANAR SYSTEMS, INC.

Customer Service

support: <http://planar.custhelp.com>

email: desktopmonitors@planar.com

phone: 1-866-PLANAR-1 (1-866-752-6271)

hours: M-F, 8am - 9pm EST

@ 2004 **Planar Systems, Inc.** Planar is a registered trademark of Planar Systems, Inc. Other brands and names are the property of their respective owners. Technical Information in this document is subject to change without notice.

Free Manuals Download Website

<http://myh66.com>

<http://usermanuals.us>

<http://www.somanuals.com>

<http://www.4manuals.cc>

<http://www.manual-lib.com>

<http://www.404manual.com>

<http://www.luxmanual.com>

<http://aubethermostatmanual.com>

Golf course search by state

<http://golfingnear.com>

Email search by domain

<http://emailbydomain.com>

Auto manuals search

<http://auto.somanuals.com>

TV manuals search

<http://tv.somanuals.com>