



PL1520M LCD Monitor

USER'S GUIDE

www.planar.com

Planar Systems, Inc

1195 NW Compton Drive
Beaverton, OR 97006-1992
www.planar.com

Customer Service

Planar provides the following technical support services:

Internet Support

For support available 24/7 visit Planar's Online Technical Support at www.planar.com/support. Our Online Technical Support is where you'll find solutions to many common problems, download documentation, view answers to frequently asked questions (FAQs) and get troubleshooting advice, or email Planar your support question.

Talk to a Customer Service Representative

To contact Planar's Customer First(TM) Technical Support Service call 1.866.PLANAR.1 (866.752.6271). This service is available 5am - 5pm Pacific Time, 8am - 8pm Eastern Time, Monday through Friday.

Contact Us

24x7 Online Technical Support: <http://www.planar.com/support>

Email: PlanarSupport@planar.com

Tel: 1-866-PLANAR1 (866) 752-6271

Hours: M-F, 5am - 5pm Pacific Time, 8am - 8pm Eastern

The information contained in this document is subject to change without notice. This document contains proprietary information that is protected by copyright. All rights are reserved. No part of this document may be reproduced, translated to another language or stored in a retrieval system, or transmitted by any means, electronic, mechanical, photocopying, recording, or otherwise, without prior written permission. Windows is a registered trademark of Microsoft Inc. Other brand or product names are trademarks of their respective holders.

TABLE OF CONTENTS

For Your Safety

<i>For Your Safety</i> -----	3
------------------------------	---

General Notes

<i>Special notes on LCD monitors</i> -----	5
--	---

Before You Operate The Monitor

<i>Features</i> -----	6
<i>Checking the contents of the package</i> -----	6

Installation Instructions

<i>Installing the base</i> -----	7
<i>Power source</i> -----	7
<i>Cable connection</i> -----	8
<i>Adjusting the viewing angle</i> -----	9

Operating Instructions

<i>General Instructions</i> -----	10
<i>How to adjust a setting</i> -----	13
<i>Source set up</i> -----	15
<i>Adjusting the sound</i> -----	16
<i>Adjusting the picture</i> -----	17
<i>Adjusting the OSD</i> -----	23

Technical Support (FAQ)

<i>Technical Support (FAQ)</i> -----	26
<i>Error message & possible solution</i> -----	26

Appendix

<i>Specifications</i> -----	28
<i>Preset display modes</i> -----	31
<i>Connector pin assignment</i> -----	32

For Your Safety

Before operating the monitor, please read this manual thoroughly. This manual should be retained for future reference.

FCC Class B Radio Frequency Interference Statement

WARNING: (FOR FCC CERTIFIED MODELS)

NOTE: This equipment has been tested and found to comply with the limits for a Class B digital device, pursuant to Part 15 of the FCC Rules. These limits are designed to provide reasonable protection against harmful interference in a residential installation. This equipment generates, uses and can radiate radio frequency energy, and if not installed and used in accordance with the instructions, may cause harmful interference to radio communications. However, there is no guarantee that interference will not occur in a particular installation. If this equipment does cause harmful interference to radio or television reception, which can be determined by turning the equipment off and on, the user is encouraged to try to correct the interference by one or more of the following measures:

1. Reorient or relocate the receiving antenna.
2. Increase the separation between the equipment and receiver.
3. Connect the equipment into an outlet on a circuit different from that to which the receiver is connected.
4. Consult the dealer or an experienced radio/TV technician for help.

NOTICE:

1. The changes or modifications not expressly approved by the party responsible for compliance could void the user's authority to operate the equipment.
2. Shielded interface cables and AC power cord, if any, must be used in order to comply with the emission limits.
3. The manufacturer is not responsible for any radio or TV interference caused by unauthorized modification to this equipment. It is the responsibilities of the user to correct such interference.

WARNING:

To prevent fire or shock hazard, do not expose the monitor to rain or moisture. Dangerously high voltages are present inside the monitor. Do not open the cabinet. Refer servicing to qualified personnel only.

Important Recycle Instruction:

(Hg) LCD Lamp(s) inside this product contain mercury. This product may contain other electronic waste that can be hazardous if not disposed of properly. Recycle or dispose in accordance with local, state, or federal Laws. For more information, contact the Electronic Industries Alliance at WWW.EIAE.ORG. For lamp specific disposal information check WWW.LAMPRECYCLE.ORG.

PRECAUTIONS

- Do not use the monitor near water, e.g. near a bathtub, washbowl, kitchen sink, laundry tub, swimming pool or in a wet basement.
- Do not place the monitor on an unstable cart, stand, or table. If the monitor falls, it can injure a person and cause serious damage to the appliance. Use only a cart or stand recommended by the manufacturer or sold with the monitor. If you mount the monitor on a wall or shelf, use a mounting kit approved by the manufacturer and follow the kit instructions.
- Slots and openings in the back and bottom of the cabinet are provided for ventilation. To ensure reliable operation of the monitor and to protect it from overheating, be sure these openings are not blocked or covered. Do not place the monitor on a bed, sofa, rug, or similar surface. Do not place the monitor near or over a radiator or heat register. Do not place the monitor in a bookcase or cabinet unless proper ventilation is provided.
- The monitor should be operated only from the type of power source indicated on the label. If you are not sure of the type of power supplied to your home, consult your dealer or local power company.
- Unplug the unit during a lightning storm or when it will not be used for long period of time. This will protect the monitor from damage due to power surges.
- Do not overload power strips and extension cords. Overloading can result in fire or electric shock.
- Never push any object into the slot on the monitor cabinet. It could short circuit parts causing a fire or electric shock. Never spill liquids on the monitor.
- Do not attempt to service the monitor by yourself; opening or removing covers can expose you to dangerous voltages and other hazards. Please refer all servicing to qualified service personnel.
- To ensure satisfactory operation, use the monitor only with UL listed computers which have appropriate configured receptacles marked between 100 - 240V AC, Min. 3.5A.
- The wall socket shall be installed near the equipment and shall be easily accessible.

GENERAL NOTES

SPECIAL NOTES ON LCD MONITORS

The following symptoms are normal with LCD monitor and do not indicate a problem.

NOTES

- Due to the nature of the fluorescent light, the screen may flicker during initial use. Turn off the Power Switch and then turn it on again to make sure the flicker disappears.
- You may find slightly uneven brightness on the screen depending on the desktop pattern you use.
- The LCD screen has effective pixels of 99.99% or more. It may include blemishes of 0.01% or less such as a missing pixel or a pixel lit all of the time.
- Due to the nature of the LCD screen, an afterimage of the previous screen may remain after switching the image, when the same image is displayed for hours. In this case, the screen is recovered slowly by changing the image or turning off the Power Switch for hours.
- When the screen becomes black or flashing, or cannot illuminate any more, contact your dealer or service center to replace parts. Don't repair the screen by yourself!

BEFORE YOU OPERATE THE MONITOR

FEATURES

- 38.1cm(15") TFT Color LCD Monitor
- Crisp, Clear Display for Windows
- Recommended Resolutions: 1024 x 768 @60Hz
- Ergonomic Design
- Space Saving, Compact Case Design

CHECKING THE CONTENTS OF THE PACKAGE

The product package should include the following items:

1. Monitor
2. Base
3. Landing Strip
4. User Manual
5. Power Cord
6. 15-Pin D-Sub Cable
7. Audio Cable
8. Composite Video Cable

Register Your Planar Products Today

Thank you for choosing Planar. To assure you receive all the benefits of your Planar product and services, register your Planar product today. Visit our website to register your product at

http://www.planar.com/support/product_registration.html

Cables, Replacement Lamps and Accessories

To find cables, replacement lamps and accessories for your Planar projector, LCD monitor, touchscreen or other Planar products visit our online store at www.PlanarOnline.com or find other stores who carry Planar products at

<http://www.planar.com/howtobuy>

INSTALLATION INSTRUCTIONS

INSTALLING AND REMOVING THE BASE:

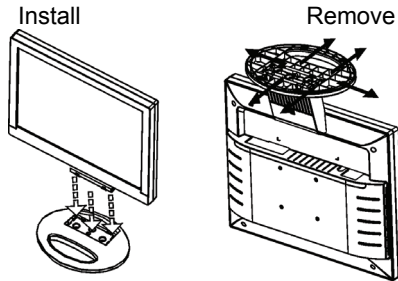

Figure 1 Installing and Removing the Base

Power Source:

1. Make sure that the power cord is the correct type required in your area.
2. This LCD monitor has an Internal universal power supply that allows operation in either 100/120V AC or 220/240V AC voltage area (No user adjustment is required.)
3. Connect the AC-power cord one end to your LCD monitor's AC-input socket , the other end to wall-outlet .

INSTALLATION INSTRUCTIONS

CABLE CONNECTIONS

- **Connecting the Signal Cable:** Plug one end of the VGA Cable to the LCD monitor's "VGA" input socket, the other end to the computer's VGA port and tighten the two screws on the cable connector.
- **Connecting the Power Cord:** Plug one end of the AC-power cord to the LCD monitor's AC input socket, the other end to a wall outlet.
- **Connecting the Audio Cable:** Plug the audio cable between the computer multi-media (or sound) card's audio output and the monitor's audio input (located on the back of the monitor).
- **Connecting the S-Video Cable:** Plug one end of the S-video cable (not included) to the LCD monitor's S-Video port and the other end to a video source output.(eg. DVD player, video recorder, a film camera with S-Video connection or a PC)
- **Connecting the Video Cable:** Plug one end of the composite video cable to the LCD monitor's composite video port and the other end to a video source .(eg. DVD player, video recorder, a film camera with video port or gaming console)

Caution: If the AC outlet is not grounded (with three holes), install the proper grounding adapter (not supplied).

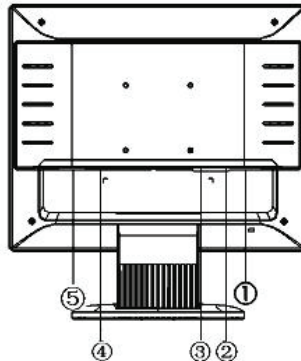

Figure 2 Connecting the Cables

- ①: Composite Video Port
- ②: S-Video Port
- ③: VGA port
- ④: Audio port
- ⑤: AC Power input port

INSTALLATION INSTRUCTIONS

ADJUSTING THE VIEWING ANGLE

- For optimal viewing it is recommended to look at the full face of the monitor, then adjust the monitor's angle to your own preference.
- Hold the stand so you do not topple the monitor when you change the monitor's angle.
- You are able to adjust the monitor's angle from -5° to 20° .

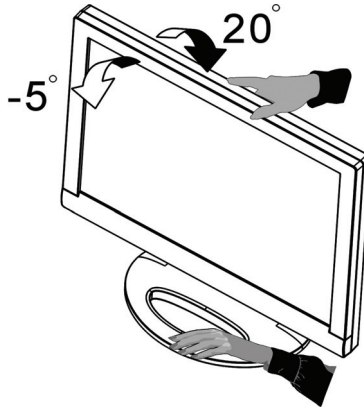

Figure 3

NOTES

- Do not touch the LCD screen when you change the angle. It may cause damage or break the LCD screen.
- Careful attention is required not to catch your fingers or hands when you change the angle.

OPERATING INSTRUCTIONS

GENERAL INSTRUCTIONS

Press the power button to turn the monitor on or off. The other control buttons are located at front panel of the monitor (See Figure 4). By changing these settings, the picture can be adjusted to your personal preferences.

- The power cord should be connected.
- Connect the Signal cable from the monitor to the VGA card.
- Connect video/S-video cable from the monitor to a video source .
- Press the power button to turn on the monitor. The power indicator will light up.

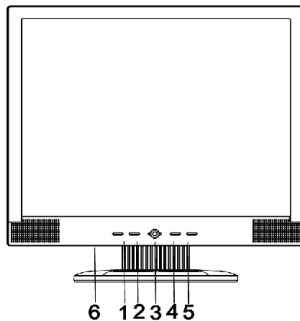

Figure 4 External Control Button

EXTERNAL CONTROLS

1.	AUTO Adjustment / Exit
2.	Vol – (Decrease) / Select menu item
3.	Power Button/LED
4.	Vol + (Increase)/ Select menu item
5.	Menu / Enter or Adjust
6.	Earphone output port

OPERATING INSTRUCTIONS(cont.)

FRONT PANEL CONTROL KNOBS

- **Power Button /Power Indicator:**

Press this button to switch ON/OFF of monitor's power.

Green — Power On mode.

Amber — Power saving mode

- **MENU / ENTER OR ADJUST :**

1. When OSD menu is not activated, press this button to activate the OSD menu.
2. When OSD menu is in activated, this button will act as an Enter key.
3. For certain functions when OSD menu is activated, this button will also act as an Adjust button.

- **“VOL+” and ">" button:**

1. When OSD menu is not activated, press this button to increase volume.
2. When OSD is activated, this button acts as a select button, moving right or down. It also increases the value of certain functions

- **“VOL-” and "<"buttons:**

1. When OSD menu is not activated, press this button to decrease volume.
2. When OSD is activated, this button acts as a select button, moving left or up. It also decreases the value of certain functions.

- **AUTO Adjust button / Exit:**

1. When OSD menu is not activated, press this button to activate the AUTO Adjustment function. (The AUTO Adjustment function is used to optimized the HPos, VPos, Clock and Focus.)
2. When OSD menu is activated, this button will act as an EXIT KEY. (EXIT OSD menu).

OPERATING INSTRUCTIONS(cont.)

OSD Lock Function:

Option 1: OSD lock - all 4 buttons are locked except the "POWER" button. Press and hold the "MENU" and ">" buttons for 3 seconds to lock the buttons. Repeat this step to unlock.

Option 2: OSD & Power button lock - all 5 buttons including the "POWER" button are locked. Press and hold the "MENU" and "<" buttons for 3 seconds to lock all 5 buttons. Repeat this step to unlock.

NOTES

- Do not install the monitor in a location near heat sources such as radiators or air ducts, or in a place subject to direct sunlight, or excessive dust or mechanical vibration or shock.
- Save the original shipping box and packing materials, as they will come in handy if you ever have to ship your monitor.
- For maximum protection, repackage your monitor as it was originally packed at the factory.
- To maintain the cleanness of your LCD display, wipe it periodically with clean and soft cloth. The screen may be damaged by any liquid splash.
- To keep the monitor looking new, periodically clean it with a soft cloth. Stubborn stains may be removed with a cloth lightly dampened with a mild detergent solution. Never use strong solvents such as thinner, benzene, or abrasive cleaners, since these will damage the cabinet. As a safety precaution, always unplug the monitor before cleaning it.

OPERATING INSTRUCTIONS (cont.)

HOW TO ADJUST A SETTING

Press the "MENU" key to activate the OSD window.

1. Press < or > to navigate through the functions. Once the desired function is highlighted, press the "MENU" key again to activate it. If the function selected has a sub-menu, press < or > again to navigate through the sub-menu functions. Once the desired function is highlighted, press "MENU" key to activate it.
2. Press < or > to change the settings of the selected function.
3. To exit and save, push the "AUTO" (Exit) key. If you want to adjust any other function, repeat steps 2-3.

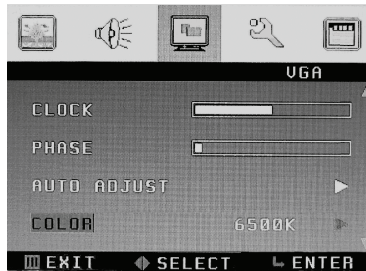







Figure 5 OSD (On Screen Display)

OPERATING INSTRUCTIONS (cont.)

MENU SELECTION

Main Menu Item	Main Menu Icon	Description	Note
Video		Picture set up for composite video & s-video mode.	Inactive when VGA source is selected.
Sound		Sound set up for all modes.	
VGA		Picture set up for PC mode	Inactive when Video/S-Video source is selected
Source		Source select between VGA/Video/S-Video	
OSD		OSD (On screen Display) Set up	

OPERATING INSTRUCTIONS (cont.)

SOURCE SET UP

Source select between VGA, Composite Video and S-Video.



Source Setting

1. Press "MENU" key to open OSD menu
2. Press>or <key to select "Source" set up option
3. Press "MENU" key to Select submenu

• VIDEO

1. Press>or <key to select "VIDEO" option
2. Press "MENU" key to activate composite video mode

• S-VIDEO

1. Press>or <key to select "S-VIDEO" option
2. Press "MENU" key to activate S-video mode

• VGA

1. Press>or <key to select "VGA" option
2. Press "MENU" key to activate VGA (PC) mode

OPERATING INSTRUCTIONS (cont.)

Sound Setup

Sets up sound for all modes. VGA, Composite Video & S-Video

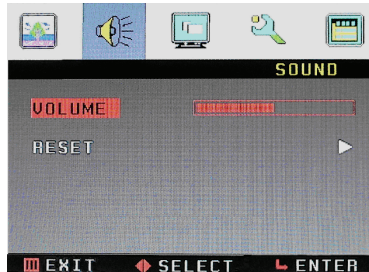

Sound Setting

1. Press "MENU" key to open OSD menu
2. Press>or <key to select "Sound" set up option
3. Press "MENU" key to Select submenu

• VOLUME

1. Press>or <key to select "VOLUME" option
2. Press "MENU" key to Select submenu
3. Press>or <key to adjust volume value.
4. After adjustment, press "AUTO" key to exit.

• RESET

1. Press>or <key to select "RESET" option
2. Press "MENU" key to recall to factory default value.
It is used to reset the volume settings to the factory default mode.
3. After adjustment, press "AUTO" key to exit.

OPERATING INSTRUCTIONS (cont.)

VGA Picture Setting

When the input source is in VGA (PC) mode, you can select Brightness, Contrast, H/V Position, Clock, Phase, AUTO, Color, and Reset as shown in the figure below:



VGA Picture Setting

1. Press "MENU" key to open OSD menu
2. Press>or <key to select "VGA" Picture Set up option
3. Press "MENU" key to Select submenu

• Brightness

1. Press>or <key to select "Brightness" option
2. Press "MENU" key to Select submenu
3. Press>or <key to adjust brightness value.
4. After adjustment, press "AUTO" key to exit.

• Contrast

1. Press>or <key to select "Contrast" option
2. Press "MENU" key to Select submenu
3. Press>or <key to adjust contrast value.
4. After adjustment, press "AUTO" key to exit.

• H-position

1. Press>or <key to select "H-position" option
2. Press "MENU" key to Select submenu
3. Press>or <key to adjust H-position data.
4. After adjustment, press "AUTO" key to exit.

OPERATING INSTRUCTIONS (cont.)

• V-position

1. Press>or <key to select “V-position” option
2. Press “MENU” key to Select submenu
3. Press>or <key to adjust V-position data.
4. After adjustment, press “AUTO” key to exit.



• CLOCK

1. Press>or <key to select “CLOCK” option
2. Press “MENU” key to Select submenu
3. Press>or <key to adjust CLOCK value.
4. After adjustment, press “AUTO” key to exit.

• PHASE

1. Press>or <key to select “Phase ” option
2. Press “MENU” key to Select submenu
3. Press>or <key to adjust PHASE value.
4. After adjustment, press “AUTO” key to exit.

• AUTO ADJUST

1. Press>or <key to select “AUTO Adjust ” option
2. Press “MENU” key to select submenu to recall to factory default value.
This will AUTOMATICALLY adjust PC input to the optimal screen size.
3. After adjustment, press “AUTO” key to exit.

OPERATING INSTRUCTIONS (cont.)

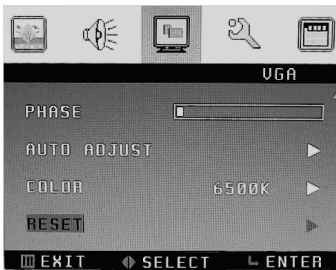

• COLOR

1. Press > or < key to select "Color" option
2. Press "MENU" key to Select submenu
3. Press "Menu" button key again to select color option.
There are three options of color temperature provided for users: 6500K, 7800K, and USER mode.
4. When in the USER model, you could personalize the R,G,B values.
 - A) Press > or < key to select R, G, or B
 - B) Press "Menu" button to select submenu
 - C) Press > or < key to adjust R/G/B value.
 - D) Press "AUTO" key to exit submenu
5. After adjustment, press "AUTO" key to exit.

• RESET

1. Press > or < key to select "RESET" option
2. Press "MENU" key to select submenu to recall to factory default value.
It is used to reset the picture settings to the factory default mode. .
3. After adjustment, press "AUTO" key to exit.

OPERATING INSTRUCTIONS (cont.)

Video Picture Setting

When the input source is in Video or S-Video mode, there are four picture modes to select: Custom, Standard, Soft & Vivid. Only Custom mode allows you to adjust Brightness, Contrast, Hue, Saturation and Sharpness.

VIDEO Picture Setting (Composite video/ S-Video mode)

1. Press "MENU" key to open OSD menu
2. Press>or <key to select "VIDEO" Picture Set up option
3. Press "MENU" key to Select submenu



• Brightness

1. Press>or <key to select "Brightness" option
2. Press "MENU" key to Select submenu
3. Press>or <key to adjust brightness value.
4. After adjustment, press "AUTO" key to exit.

• Contrast

1. Press>or <key to select "Contrast" option
2. Press "MENU" key to Select submenu
3. Press>or <key to adjust contrast value.
4. After adjustment, press "AUTO" key to exit.

• HUE (only works for NTSC systems)

1. Press>or <key to select "Hue" option
2. Press "MENU" key to Select submenu
3. Press>or <key to adjust Hue data.
4. After adjustment, press "AUTO" key to exit.

OPERATING INSTRUCTIONS (cont.)

• SATURATION

1. Press>or <key to select “SATURATION” option
2. Press “MENU” key to Select submenu
3. Press>or <key to adjust SATURATION value.
4. After adjustment, press “AUTO” key to exit.

• SHARPNESS

1. Press>or <key to select “SHARPNESS” option
2. Press “MENU” key to Select submenu
3. Press>or <key to adjust Sharpness value.
4. After adjustment, press “AUTO” key to exit.



• PICTURE MODE

1. Press>or <key to select “PICTURE MODE” option
2. Press “MENU” key to adjust picture mode data. There are four options of PICTURE MODE provided: CUSTOM, STANDARD,SOFT, & VIVID. After adjustment, press “AUTO” key to exit.



OPERATING INSTRUCTIONS (cont.)



- BLACK LEVEL

1. Press>or <key to select “Black level” option
2. Press “MENU” key to turn On or Off black level
3. After adjustment, press “AUTO” key to exit.

- RESET

1. Press>or <key to select “RESET” option
2. Press “MENU” key to select submenu ro recall to factory default data.
It is used to reset the picture settings to the factory default mode. .
3. After adjustment, press “AUTO” key to exit.

OPERATING INSTRUCTIONS (cont.)

OSD (On Screen Display) SET UP

When the input source is in VGA, Composite video or S-Video mode, you can adjust OSD as shown in the figure below:

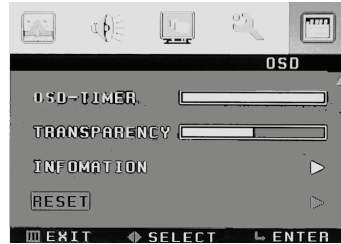

OSD Setting

1. Press "MENU" key to open OSD menu
2. Press>or <key to select "OSD" Set up option
3. Press "MENU" key to Select submenu

• Language

1. Press>or <key to select "Language" option
2. Press "MENU" key to adjust language. There are four language to select: English, Simplified Chinese, French, Spanish,
3. After adjustment, press "AUTO" key to exit.

• H-position

1. Press>or <key to select "H-position" option
2. Press "MENU" key to move the OSD to the right. To move the OSD to the left, continue to push "Menu" key until it loops to the left of the display.
3. After adjustment, press "AUTO" key to exit.

• V-position

1. Press>or <key to select "V-position" option
2. Press "MENU" key to move the OSD down. To move the OSD to the top, continue to push "Menu" key until it loops to the top of the display.
3. After adjustment, press "AUTO" key to exit.

• OSD Timer

1. Press>or <key to select "OSD-Timer" option
2. Press "MENU" key to Select submenu
3. Press>or <key to select adjust OSD display time.
4. After adjustment, press "AUTO" key to exit.

OPERATING INSTRUCTIONS (cont.)

• TRANSPARENCY

1. Press>or <key to select “TRANSPARENCY” option
2. Press “MENU” key to Select submenu
3. Press>or <key to adjust the transparency of OSD view.
4. After adjustment, press “AUTO” key to exit.

• INFORMATION

1. Press>or <key to select “INFORMATION” option
2. Press “MENU” key to display current input Information
3. After adjustment, press “AUTO” key to exit.

• RESET

1. Press>or <key to select “RESET” option
2. Press “MENU” key to select submenu ro recall to factory default data.
3. After adjustment, press “AUTO” key to exit.

OPERATING INSTRUCTIONS (cont.)

PLUG AND PLAY

Plug & Play DDC2B Feature

This monitor is equipped with VESA DDC2B capabilities according to the VESA DDC STANDARD. It allows the monitor to inform the host system of its identity and, depending on the level of DDC used, communicate additional information about its display capabilities.

The DDC2B is a bidirectional data channel based on the I²C protocol. The host can request EDID information over the DDC2B channel.

THIS MONITOR WILL APPEAR TO BE NON-FUNCTIONAL IF THERE IS NO VIDEO INPUT SIGNAL. IN ORDER FOR THIS MONITOR TO OPERATE PROPERLY, THERE MUST BE A VIDEO INPUT SIGNAL.

This monitor meets the Green monitor standards as set by the Video Electronics Standards Association (VESA) and/or the United States Environmental Protection Agency (EPA) and The Swedish Confederation Employees (NUTEK). This feature is designed to conserve electrical energy by reducing power consumption when there is no video-input signal present. When there is no video input signal this monitor, following a time-out period, will AUTOMATICALLY switch to an OFF mode. This reduces the monitor's internal power supply consumption. After the video input signal is restored, full power is restored and the display is AUTOMATICALLY redrawn. The appearance is similar to a "Screen Saver" feature except the display is completely off. The display is restored by pressing a key on the keyboard, or clicking the mouse.

TECHNICAL SUPPORT (FAQ)

Problem & Question	Possible Solution
Power LED is not on	*Check if the Power Switch is in the ON position *Power Cord should be connected
No Plug & Play	*Check if the PC system is Plug & Play compatible *Check if the Video Card is Plug & Play compatible *Check if the D-15 plug pin of Video Cable is bent.
Picture is fuzzy	*Adjust the Contrast and Brightness Controls.
Picture bounces or a wave pattern is present in the picture	*Move electrical devices that may cause electrical interference.
The power LED is ON (Amber) but there's no video or no picture.	*Computer Power Switch should be in the ON position. *Computer Video Card should be snugly seated in its slot. *Make sure monitor's video cable is properly connected to the computer. *Inspect monitor's video cable and make sure none of the pins are bent. *Make sure computer is operational by hitting the CAPS LOCK key on the keyboard while observing the CAPS LOCK LED. The LED should either turn ON or OFF after hitting the CAPS LOCK key.
Missing one of the primary colors (RED, GREEN, or BLUE)	*Inspect the monitor's video cable and make sure that none of the pins are bent.
Screen image is not centered or sized properly.	*Adjust pixel frequency (CLOCK) and FOCUS or press hot-key (AUTO).
Picture has color defects (white does not look white)	*Adjust RGB color or select color temperature.
Horizontal or vertical disturbances on the screen	*Use win 95/98 shut-down mode Adjust CLOCK and FOCUS or perform hot- key (AUTO-key).

TECHNICAL SUPPORT (FAQ) (cont.)

CLOCK (pixel frequency) controls the number of pixels scanned by one horizontal sweep. If the frequency is not correct, the screen shows vertical stripes and the picture has not correct width.

FOCUS adjusts the phase of the pixel clock signal. With a wrong phase adjustment the picture has horizontal disturbances in light picture.

For FOCUS and CLOCK adjustment use “dot-pattern” or win 95/98 shut-down mode pattern.

ERROR MESSAGE & POSSIBLE SOLUTION

NO SIGNAL:

1. Check that the signal cables are proper connected , If the connector is loose, tighten the connector's screws.
2. Check the signal-cable's connection pins for damage.

UNSUPPORTED:

Your computer resolution is out of VESA-SPEC

APPENDIX

SPECIFICATIONS

Items		Specification
LCD Panel	Screen Size	15" screen
	Aspect Ratio	4 : 3
	Resolution	1024x768(XGA)
	Size	38.1cm(15.0")
	Pixel Pitch	0.297mm x 0.297mm
	Display colors	16.7 million
	Contrast Ratio	450:1
	Brightness	250cd/m ²
	Viewing Angle	120° (Horizontal)/ 100° (Vertical)
	Response Time	16ms
	Lamp Type/Life	50000 hr
	Color Temperature	6500k / 7800k / User
Video Input	Composite Video, S-Video	RCA x 1 S-Video x 1
	Video Systems	NTSC, PAL
	Audio Input	Audio mini-jack In x1
Headphone Ouput		Headphone Ouput x1

APPENDIX

PC Input	Signal Input	Analog: D-Sub 15 pin (detachable cable)
	PnP compatibility	DDC 2B
	Input frequency	Analog: FH:30KHz to 60KHz FV:55Hz to75Hz
	Recommended	Analog: 1024x 768 (60Hz)
	Input Audio	mini-jack 3.5mm x 1 (Shared)
Audio Output	Audio Output: L / R	Speaker (built-in): Max 1W Per channel
		Headphone Mini-jack for stereo (3.5ø)
OSD language	English. Simplified Chinese .French. Spanish.	
Wall Mount	VESA 75 x 75 mm	
Power	Power Supply	AC100V~240V, 50/60Hz
	Power Consumption	<25W
Panel Tilt	Forwards/Backwards	- 5° ~ 20°
Environment	operating	+ 5 °C ~ + 40 °C
	storage	- 25 °C ~ + 60 °C
	Operating	10% ~ 85%
Dimension	W x H x D (with stand)	362 (W) x 357.5 (H) x 144 (D)mm
Weight (net)	Kg (w/o Accessories)	3 Kg
Accessories	Power Cord, VGA cable, Audio cable, Composite Video cable, User's Manual, and Landing Strip.	
Regulatory Compliance	UL, cUL, FCC-B, CE	

APPENDIX (cont.)

Functions	VGA:	<ul style="list-style-type: none">• BRIGHTNESS• CONTRAST• H-POSITION• V-POSITION• CLOCK• PHASE• AUTO ADJUST• COLOR• RESET
	OSD:	<ul style="list-style-type: none">• LANGUAGE• H-POSITION• V-POSITION• OSD-TIMER• TRANSPARENCY• INFORMATION• RESET
	VIDEO:	<ul style="list-style-type: none">• BRIGHTNESS• CONTRAST• HUE• SATURATION• SHARPNESS• PICTURE MODE• BLACK LEVEL• RESET
	SOURCE:	<ul style="list-style-type: none">• VIDEO• S-VIDEO• VGA
	SOUND:	<ul style="list-style-type: none">• VOLUME• RESET

APPENDIX (cont.)

Preset Display Modes

STANDARD	RESOLUTION	HORIZONTAL FREQUENCY (kHz)	VERTICAL FREQUENCY (Hz)
VESA MODES			
VGA	640x480	31.47	60.0
	640x480	37.50	75.0
	640x480	37.861	72.8
SVGA	800X600	35.156	56.3
	800X600	37.879	60.0
	800X600	48.077	72.2
	800X600	46.875	75.0
XGA	1024X768	48.363	60.0
	1024X768	56.476	70.0
	1024×768	60.02	75.0
IBM MODES			
DOS	640x400	31.469	70.087
DOS	720X400	31.469	70.087
XGA	1024x768	57.515	72.1
MAC MODES			
VGA	640X480	35	66.667
SVGA	832X624	49.725	74.551
XGA	1024x768	48.780	60.001
	1024x768	60.241	74.927

APPENDIX (cont.)

CONNECTOR PIN ASSIGNMENT

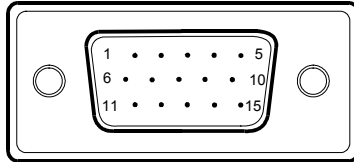

15 - Pin Color Display Signal Cable

PIN NO.	DESCRIPTION	PIN NO.	DESCRIPTION
1.	Red	9.	+5V
2.	Green	10.	VGA-CON
3.	Blue	11.	TXD
4.	RXD	12.	DDC-Serial Data
5.	Ground	13.	H-Sync
6.	R-Ground	14.	V-Sync
7.	G-Ground	15.	DDC-Serial Clock
8.	B-Ground		

S-Video port

	Pin	Meaning
	1	GND
	2	GND
	3	Luminance (Y)
	4	Chrominance (C)

Planar Systems, Inc

1195 NW Compton Drive
Beaverton, OR 97006-1992
www.planar.com

© 2006 Planar Systems, Inc.

Planar is a registered trademark of Planar Systems, Inc. Other brands and names are the property of their respective owners. Technical information in this document is subject to change without notice.



Q41T5000935 2C

Free Manuals Download Website

<http://myh66.com>

<http://usermanuals.us>

<http://www.somanuals.com>

<http://www.4manuals.cc>

<http://www.manual-lib.com>

<http://www.404manual.com>

<http://www.luxmanual.com>

<http://aubethermostatmanual.com>

Golf course search by state

<http://golfingnear.com>

Email search by domain

<http://emailbydomain.com>

Auto manuals search

<http://auto.somanuals.com>

TV manuals search

<http://tv.somanuals.com>