

PLANAR®

PLANAR LCD MONITOR PQ150 MANUAL

www.planar.com

This unit has been engineered and manufactured to ensure your personal safety, however improper use may result in electrical shock or fire hazards. In order to allow the proper operation of all safeguards incorporated in this display, observe the following basic rules for its installation, use, and servicing.

On Safety

Use only the power cord supplied with the unit. In case you use another power cord, make sure that it is certified by the applicable national standards if not being provided by the supplier. If the power cable is faulty in any way, please contact the manufacturer or the nearest authorized repair service provider for a replacement.

The power supply cord is used as the main disconnection device. Ensure that the socket-outlet is easily accessible after installation.

Operate the display only from a power source indicated in the specifications of this manual or listed on the display. If you are not sure what type of power supply you have in your home, consult with your dealer.

Overloaded AC outlets and extension cords are dangerous. So are frayed power cords and broken plugs. They may result in a shock or fire hazard. Call your service technician for replacement.

Do not Open the Display.

- There are no user serviceable components inside.
- There are Dangerous High Voltages inside, even when the power is OFF.
- Refer first to the Troubleshooting section of this manual in case of difficulty.

To Avoid Personal Injury :

- Do not place the display on a sloping shelf unless properly secured.
- Use only a stand recommended by the manufacturer.

To Prevent Fire or Hazards:

- Always turn the display OFF if you leave the room for more than a short period of time. Never leave the display ON when leaving the house.
- Keep children from dropping or pushing objects into the display's cabinet openings. Some internal parts carry hazardous voltages.
- Do not add accessories that have not been designed for this display.
- During a lightning storm or when the display is to be left unattended for an extended period of time, unplug it from the wall outlet.

On Installation

Do not allow anything to rest upon or roll over the power cord, and do not place the display where the power cord is subject to damage.

Do not use this display near water such as near a bathtub, washbowl, kitchen sink, laundry tub, in a wet basement, or near a swimming pool.

Displays are provided with ventilation openings in the cabinet to allow the release of heat generated during operation. If these openings are blocked, built-up heat can cause failures which may result in a fire hazard. Therefore, NEVER:

- Block the bottom ventilation slots by placing the display on a bed, sofa, rug, etc.
- Place the display in a built-in enclosure unless proper ventilation is provided.
- Cover the openings with cloth or other material.
- Place the display near or over a radiator or heat source.

Do not rub or strike the Active Matrix LCD with anything hard as this may scratch, mar, or damage the Active Matrix LCD permanently.

Do not press the LCD screen with your finger for a long time as this may cause some afterimages.

Some dot defects may appear as Red, Green or Blue spots on the screen. However, this will have no impact or effect on the display performance.

If possible, use the recommended resolution to obtain the best image quality for your LCD display. If used under any mode except the recommended resolution, some scaled or processed images may appear on the screen. However, this is characteristic of the fixed-resolution LCD panel.

On Cleaning

- Unplug the display before cleaning the face of the display screen.
- Use a slightly damp (not wet) cloth. Do not use an aerosol directly on the display screen because over-spraying may cause electrical shock.

On Repacking

- Do not throw away the carton and packing materials. They make an ideal container in which to transport the unit. When shipping the unit to another location, repack it in its original material.

Connecting the Display

- Before setting up the monitor, ensure that the power to the monitor, the computer system, and other attached devices is turned off.

Unfolding the stand base

1. Lay the monitor on a cushion or piece of soft cloth with its front side facing upward.
2. Grasp the stand firmly with both hands as shown in the picture and unfold the base by swiveling it out. Significant force is required.



Folding the stand base

1. Lay the monitor on a cushion or piece of soft cloth with its front side facing downward.
2. Grasp the stand firmly with two hands and rotate the base while pulling out its underside.

 **Caution** : If you try to fold the stand base in any other way, be careful to avoid catching your hand at the rear of the unit or you may sustain injury.

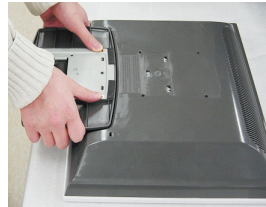
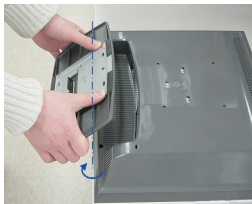

Important

- If the stand base is wrenched with excessive force when being folded or unfolded the monitor may be damaged. Handle with care.
- Adjust the angle of the stand base holding the monitor screen with two hands.



Connecting the Display

Using the Computer

1. Connect the signal cable. When attached, tighten the thumbscrews to secure the connection.
2. Connect the power cord into a proper power outlet that is easily accessible and close to the display.

NOTE



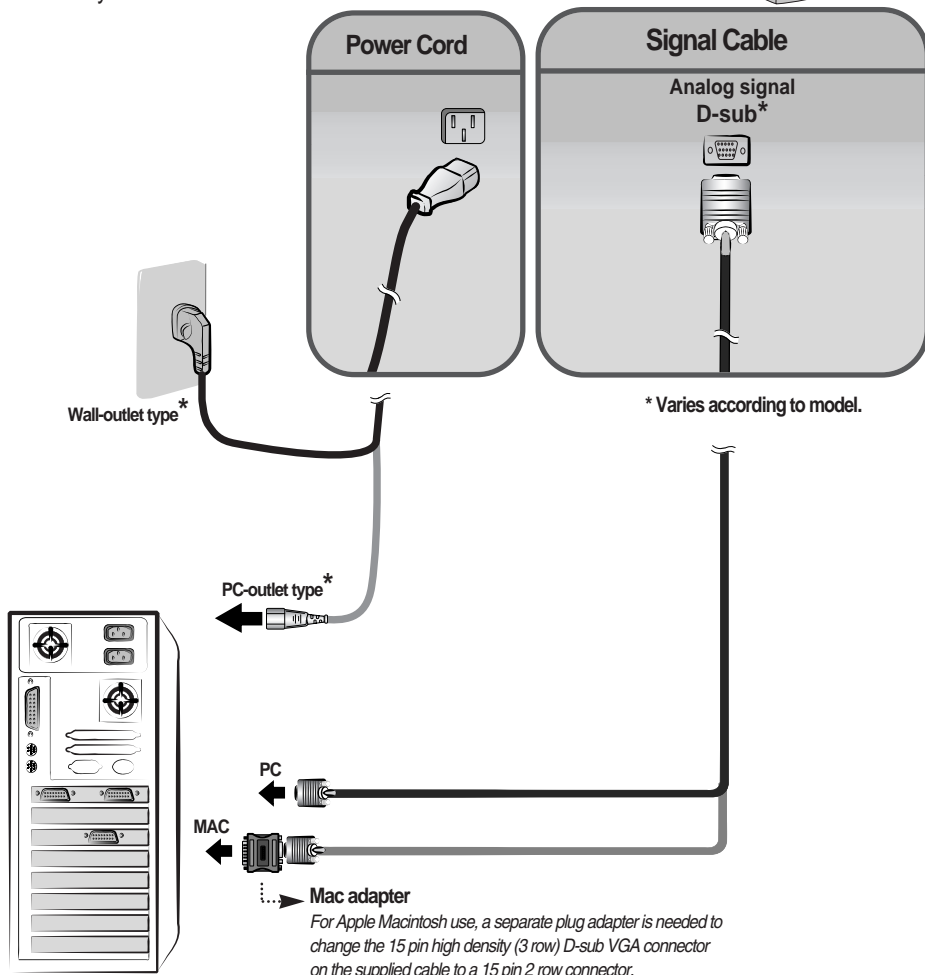
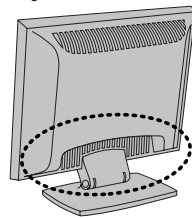

- This is a simplified representation of the rear view.
- This rear view represents a general model; your display may differ from the view as shown.

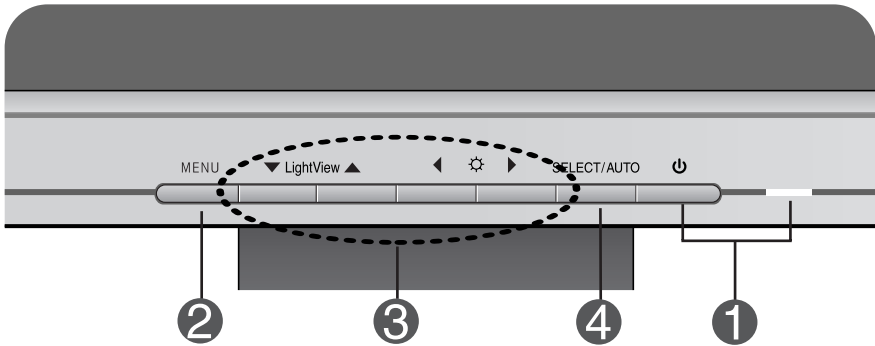

Front Panel Controls

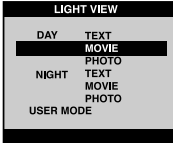
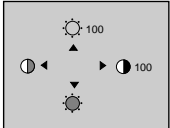

Control	Function
1 Power Button Power (DPMS) Indicator	Use this button to turn the display on or off. This Indicator lights up green when the display operates normally. If the display is in DPM (Energy Saving) mode, this indicator color changes to amber.
2 MENU Button	Use this button to enter or exit the On Screen Display.
3 ▼▲◀▶ Buttons	Use these buttons to choose or adjust items in the On Screen Display.
4 SELECT/AUTO Button	Use this button to enter a selection in the On Screen Display.

Control	Direct Access Function
 <p>The image shows a rectangular OSD menu titled "LIGHT VIEW". It contains a grid of options: "DAY" and "TEXT" in the top row, "NIGHT" and "TEXT" in the second row, "MOVIE" and "MOVIE" in the third row, "PHOTO" and "PHOTO" in the fourth row, and "USER MODE" in the bottom row.</p>	<h3 style="margin: 0;">③ ▼ LightView ▲</h3> <p>This function optimizes the brightness, contrast or color value to the surrounding conditions and settings and enables you to enjoy the most suitable picture by adjusting the surroundings (DAY/NIGHT/USER MODE).</p> <ul style="list-style-type: none"> • TEXT: For viewing letters • MOVIE: For viewing movies • PHOTO: For viewing pictures or the photographs • USER MODE: This function memorizes the manual adjustment -Brightness, Contrast and Color value on the On Screen Display.
 <p>The image shows a circular OSD for adjusting brightness and contrast. It features a sun icon at the top with "100" next to it, a moon icon at the bottom with "100" next to it, and a central sun icon. Four arrows point outwards from the center to indicate adjustment directions.</p>	<p style="text-align: center;">◀ ☀ ▶</p> <p>Bring up Contrast and Brightness adjustment.</p> <p style="text-align: center;">: ◀ ☀ ▶ → ▼ ▲ ◀ ▶ → MENU</p>
 <p>The image shows a rectangular OSD with a black border containing the text "PROCESSING" and "AUTO CONFIGURATION" stacked vertically.</p>	<h3 style="margin: 0;">④ AUTO adjustment function</h3> <p>When adjusting your display settings, always press the SELECT/AUTO button before entering the On Screen Display(OSD). This will automatically adjust your display image to the ideal settings for the current screen resolution size (display mode).</p> <p>The best display mode is 1024x768.</p>
 <p>The image shows a rectangular OSD with a black border containing the text "CONTROLS LOCKED".</p>	<h3 style="margin: 0;">CONTROLS LOCKED/UNLOCKED</h3> <p style="margin: 0;">: MENU and ▶</p>
 <p>The image shows a rectangular OSD with a black border containing the text "CONTROLS UNLOCKED".</p>	<p>This function allows you to secure the current control settings, so that they cannot be inadvertently changed. Press and hold the MENU button and ▶ button for 3 seconds: the message “CONTROLS LOCKED” appears.</p> <p>You can unlock the OSD controls at any time by pushing the MENU button and ▶ button for 3 seconds: the message “CONTROLS UNLOCKED” will appear.</p>

Screen Adjustment

Making adjustments to the image size, position and operating parameters of the display is quick and easy with the On Screen Display Control system. A short example is given below to familiarize you with the use of the controls. The following section is an outline of the available adjustments and selections you can make using the OSD.

NOTE

- Allow the display to stabilize for at least 30 minutes before making image adjustments.

To make adjustments in the On Screen Display, follow these steps:

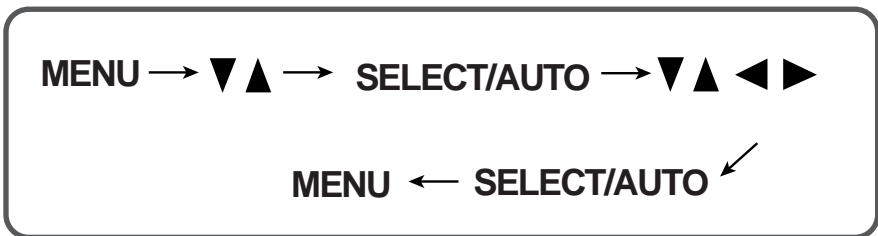

- 1 Press the **MENU** Button, then the main menu of the OSD appears.
- 2 To access a control, use the **▼** or **▲** Buttons. When the icon you want becomes highlighted, press the **SELECT/AUTO** Button.
- 3 Use the **▼ ▲ ◀ ▶** Buttons to adjust the item to the desired level.
- 4 Accept the changes by pressing the **SELECT/AUTO** Button.
- 5 Exit the OSD by Pressing the **MENU** Button.

On Screen Display(OSD) Selection and Adjustment

The following table indicates all the On Screen Display control, adjustment, and setting menus.

Main menu	Sub menu		Reference
BRIGHTNESS CONTRAST	BRIGHTNESS		● To adjust the brightness and contrast of the screen
	CONTRAST		
COLOR	PRESET	9300K	● To customize the color of the screen
		6500K	
	R/G/B(User Color)		
	GAMMA		
POSITION	V POSITION		● To adjust the position of the screen
	H POSITION		
TRACKING	CLOCK		● To improve the clarity and stability of the screen
	PHASE		
SETUP	LANGUAGE		● To customize the screen status for a user's operating environment
	OSD POSITION		
	FACTORY RESET		
● : Adjustable			

NOTE

- The order of icons may differ depending on the model (A8~A10).



On Screen Display(OSD) Selection and Adjustment

You were introduced to the procedure of selecting and adjusting an item using the OSD system. Listed below are the icons, icon names, and icon descriptions of the all items shown on the Menu.

NOTE

- OSD (On Screen Display) menu languages on the monitor may differ from the manual.

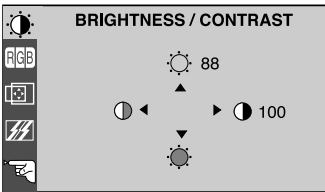

To adjust the brightness and contrast of the screen

OSD Adjust	Description
	 BRIGHTNESS To adjust the brightness of the screen.
	 CONTRAST To adjust the contrast of the screen.

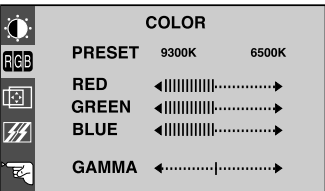
To customize the color of the screen

OSD Adjust	Description
	PRESET 9300K/6500K Select the screen color. <ul style="list-style-type: none">9300K: Slightly bluish white.6500K: Slightly reddish white.
	RED GREEN BLUE Set your own color levels.
	GAMMA Set your own gamma value. (-50~50) On the monitor, high gamma values display whitish images and low gamma values display high contrast images.

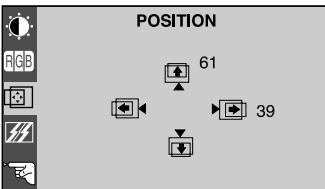
To adjust the position of the screen

OSD Adjust	Description
	 Vertical Position To move image up and down.
	 Horizontal Position To move image left and right.

To improve the clarity and stability of the screen

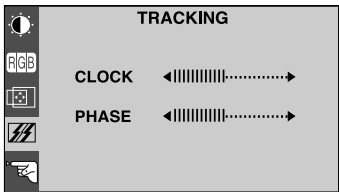
OSD Adjust	Description
	<p>CLOCK To minimize any vertical bars or stripes visible on the screen background. The horizontal screen size will also change.</p> <p>PHASE To adjust the focus of the display. This item allows you to remove any horizontal noise and clear or sharpen the image of characters.</p>

To customize the screen status for a user's operating environment

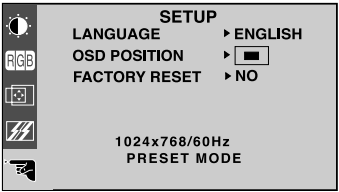
OSD Adjust	Description
	<p>LANGUAGE To choose the language in which the control names are displayed.</p> <p>OSD POSITION To adjust position of the OSD window on the screen.</p> <p>FACTORY RESET Return to all factory default settings except "LANGUAGE". If you don't want to reset the monitor, use the ◀ ▶ button to select NO and then press the SELECT/AUTO button.</p>

Check the following before calling for service.



No image appears	
<ul style="list-style-type: none">● Is the power cord of the display connected?	<ul style="list-style-type: none">• Check and see if the power cord is connected properly to the power outlet.
<ul style="list-style-type: none">● Is the power indicator light on?	<ul style="list-style-type: none">• Press the Power button.
<ul style="list-style-type: none">● Is the power on and the power indicator green?	<ul style="list-style-type: none">• Adjust the brightness and the contrast.
<ul style="list-style-type: none">● Is the power indicator amber?	<ul style="list-style-type: none">• If the display is in power saving mode, try moving the mouse or pressing any key on the keyboard to bring up the screen.• Make sure if the power is on.• Try to turn on the PC.
<ul style="list-style-type: none">● Do you see an "INPUT SIGNAL OUT OF RANGE" message on the screen?	<ul style="list-style-type: none">• This message appears when the signal from the PC (video card) is out of horizontal or vertical frequency range of the display. Typically this issue can be resolved by restarting the PC with the display connected.
<ul style="list-style-type: none">● Do you see a "NO SIGNAL" message on the screen?	<ul style="list-style-type: none">• This message appears when the signal cable between your PC and your display is not connected. Check the signal cable and try again.

Do you see a "CONTROLS LOCKED" message on the screen?	
<ul style="list-style-type: none">● Do you see "CONTROLS LOCKED" when you push MENU button?	<ul style="list-style-type: none">• You can secure the current control settings, so that they cannot be inadvertently changed. You can unlock the OSD controls at any time by pushing the MENU button and ► button for 3 seconds: the message "CONTROLS UNLOCKED" will appear.

Display image is incorrect

- | | |
|---|---|
| <ul style="list-style-type: none">● Display Position is incorrect.
● On the screen background, vertical bars or stripes are visible.
● Any horizontal noise appearing in any image or characters are not clearly portrayed.
● The screen color is mono or abnormal.
● The screen blinks. | <ul style="list-style-type: none">• Press the SELECT/AUTO button to automatically adjust your display image to the ideal setting.
If the results are unsatisfactory, adjust the image position using the H position and V position icon in the on screen display.• Check Control Panel --> Display --> Settings and see if the frequency or the resolution were changed. If yes, readjust the video card to the recommend resolution.
• Press the SELECT/AUTO button to automatically adjust your display image to the ideal setting.
If the results are unsatisfactory, decrease the vertical bars or stripes using the CLOCK icon in the on screen display.
• Press the SELECT/AUTO button to automatically adjust your display image to the ideal setting.
If the results are unsatisfactory, decrease the horizontal bars using the PHASE icon in the on screen display.• Check Control Panel --> Display --> Settings and adjust the display to the recommended resolution or adjust the display image to the ideal setting. Set the color setting higher than 24 bits (true color).
• Check if the signal cable is properly connected and use a screwdriver to fasten if necessary.• Make sure the video card is properly inserted in the slot.• Set the color setting higher than 24 bits (true color) at Control Panel - Settings.
• Check if the screen is set to interlace mode and if yes, change it to the recommend resolution.• Make sure the power voltage is high enough, It has to be higher than AC100-240V 50/60Hz. |
|---|---|

Specifications

Display	Flat Panel Active matrix-TFT LCD 15 inches diag viewable, Anti-Glare coating, 0.3 mm pixel pitch Horizontal Viewing Angle: -60 to +60 deg typical Vertical Viewing Angle: -45 to +45 deg typical	
Sync Input	Horizontal Freq.	30 - 63kHz (Automatic)
	Vertical Freq.	56 - 75Hz (Automatic)
	Input Form	Separate TTL, Positive/Negative
Video Input	Signal Input	15 pin D-Sub Connector
	Input Form	RGB Analog (0.7Vp-p/75ohm)
Resolution	Max	VESA 1024 x 768@75Hz
	Recommend	VESA 1024 x 768@60Hz
Plug&Play	DDC 2B	
Power Consumption	Normal	: 25W
	Stand-by/Suspend	≤ 3W
	DPMS Off	≤ 3W
Dimensions & Weight (with tilt stand)	Full Up Position	
		
	width	35.00 cm / 13.78 inches
	Height	31.80 cm / 12.52 inches
	Depth	13.30 cm / 5.24 inches
	Net	2.5 kg (5.51 lbs)
Folded Position		
		
width	35.00 cm / 13.78 inches	
Height	33.40 cm / 13.15 inches	
Depth	6.40 cm / 2.52 inches	
Tilt Range	Tilt	0° to 25°
Power Input	AC 100-240V~ 50/60Hz 0.6A	
Environmental Conditions	Operating Conditions	
	Temperature	10°C to 35 °C
	Humidity	10 % to 80 % non-Condensing
	Storage Conditions	
Temperature	-20°C to 60 °C	
Humidity	5 % to 95 % non-Condensing	
Brightness	250 cd/m2 typical	
Contrast	350:1 typical	
Power cord	Wall-outlet type	
Regulations	UL, cUL, FCC	

NOTE

- Information in this document is subject to change without notice.

Preset Modes (Resolution)

	Display Modes (Resolution)	Horizontal Freq. (kHz)	Vertical Freq. (Hz)
1	VGA 640 x 350	31.468	70
2	VGA 720 x 400	31.468	70
3	VGA 640 x 480	31.469	60
4	VESA 640 x 480	35.000	66.67
5	VESA 640 x 480	37.861	72.8
6	VESA 640 x 480	37.500	75
7	VESA 800 x 600	35.156	56.25
8	VESA 800 x 600	37.879	60
9	VESA 800 x 600	48.077	72
10	VESA 800 x 600	46.875	75
11	MAC 832 x 624	49.725	75
*12	VESA 1024 x 768	48.363	60
13	VESA 1024 x 768	56.476	70
14	VESA 1024 x 768	60.023	75

*Recommended

Unlike CRT monitors, which require a high refresh rate to minimize flickering, TFT technology is inherently flicker-free. If possible, configure your computer for 1024 x 768 addressability at 60Hz vertical refresh rate.

VESA wall mounting

Connected to another object (stand type and wall-mounted type. This monitor accepts a VESA-compliant mounting interface pad.)

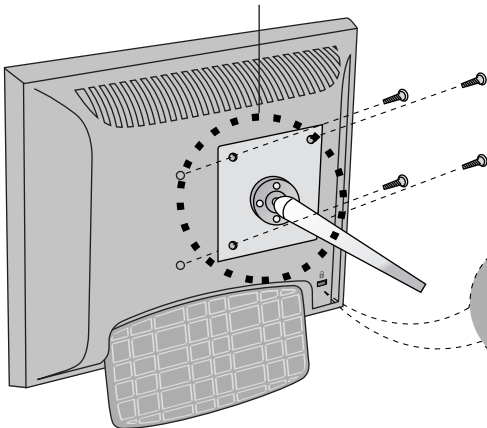

Kensington Security Slot- optional

Connected to a locking cable that can be purchased separately at most computer stores

PLANAR SYSTEMS, INC.

Customer Service

support: <http://planar.custhelp.com>

email: desktopmonitors@planar.com

phone: 1-866-PLANAR-1 (1-866-752-6271)

hours: M-F, 8am - 9pm EST

© 2003 **Planar Systems, Inc.** Planar is a registered trademark of Planar Systems, Inc. Other brands and names are the property of their respective owners.
Technical information in this document is subject to change without notice. 0000

Free Manuals Download Website

<http://myh66.com>

<http://usermanuals.us>

<http://www.somanuals.com>

<http://www.4manuals.cc>

<http://www.manual-lib.com>

<http://www.404manual.com>

<http://www.luxmanual.com>

<http://aubethermostatmanual.com>

Golf course search by state

<http://golfingnear.com>

Email search by domain

<http://emailbydomain.com>

Auto manuals search

<http://auto.somanuals.com>

TV manuals search

<http://tv.somanuals.com>