



XP37W
LCD TV

USER'S GUIDE

www.planar.com

Table of contents

1. General Information	3
2. Safety Precautions	5
3. Features	7
4. Ports	8
5. Control Buttons	9
6. Accessories	10
7. Remote Control	11
8. Summary of Remote Control Functions	12
9. Connections & Applications	13
10. Controls & Adjustments	
A. General Adjustments	16
Turning the LCD TV On and Off	16
Viewing the Menus and On-Screen Displays	16
Switching between PC/HD/S-Video/TV/Component Modes	17
Switching Language Modes	17
Setting the Sleep Timer	18
Adjusting the Volume	18
B. PC mode Adjustments	19
Adjusting the Contrast and Backlight Settings	19
Adjusting PC Settings	19
Adjusting Sound Settings	20
Viewing Picture-in-Picture (PIP) Settings	23
C. General TV mode Adjustment	26
Adjusting the TV Settings	26
Sound Options	26
Adjusting Picture Settings	27
Memorizing Channels	28
Changing Channels	30
Using Parent Control	31
Setting Up Your Personal ID Number (PIN)	32
How to Set up Restrictions Using the "Blocking Movie" function	36
Child Lock	37
Viewing Closed Captions	38
D. DTV System	39

Channel Scan	39
Auto Scan.....	40
Manual Scan	42
Time Zone.....	44
Channel Control.....	45
DTV Rating Setting	48
Rating(Lock Programs by Rating).....	49
Closed Caption Options.....	50
INFO.....	51
MTS(Multi-track Language Selection-Design).....	52
Favorite Channel List.....	53
Selecting Digital Channels.....	54
Freezing the Picture	54
E. Other Functions	55
11. Programming Remote Control	56
A. Direct Device Code Setup.....	56
B. Searching for a Device Code	57
C. Device Codes	58
12. Troubleshooting.....	64
13. PC Input Preset Timing Table	67
14. Specifications	68

General Information

This 37" wide active matrix TFT (thin film transistor) liquid crystal monitor is designed for use as a stand alone TV as well as a display device for video electronics appliances and personal computers.

Important Information

Warning: To reduce the risk of fire or electric shock, do not expose this product to rain or moisture.

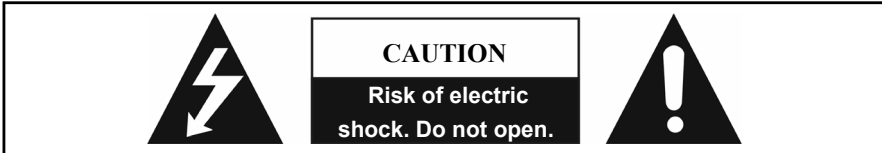

Caution: To reduce the risk of electric shock, do not attempt to disassemble or modify this device. There are no user-serviceable parts inside. Refer any service issues to qualified service personnel.

Caution: FCC/ CSA regulations state that any unauthorized changes or modifications to this equipment may void the user's authority to operate it.

Important: One Federal Court has held that unauthorized recording of copyrighted TV programs is an infringement of U.S. copyright laws. Certain Canadian programs may also be copyrighted and any unauthorized recording in whole or in part may be in violation of these rights.

WARNING:

Do not leave stationary images, patterns, PIP windows, or letterbox images on the screen for prolonged periods of time as this may result in permanent damage to the LCD panel. This type of damage is not covered under warranty. The following are examples of, but not limited to, potentially hazardous display output: side bar images, video game patterns, closed captioning, channel logos and letterbox black bars. To prevent this type of damage, it is recommended to display constantly moving images that fill the screen as often as possible.

According to industrial standards for LCD display technology; there are a certain number of allowable defective pixels. Although we produce panels with more than 99.9% active cells, there still may be some cells that do not produce light or remain constantly lit. For further information, please contact sales or technical support.

Thank You for Choosing This Product

Your new LCD TV was built utilizing the latest advancements in television technology. We are proud to offer you a product that will provide convenient, dependable service and enjoyment for years to come.

Safety Precautions

1. **Cleaning:** Unplug the power cord from the AC outlet before cleaning the product. Use a damp cloth to clean the product. Do not use liquid cleaners or aerosol cleaners.
2. **Water and moisture:** Do not use the product near water or areas of high moisture content such as swimming pools, bathtubs or wet basements.
3. **Heat sources:** Keep the product away from heat sources such as radiators, heaters, stoves and other heat-generating products (including amplifiers).
4. For added protection during a lightning storm or for extended periods of non-use, unplug the power cord from the wall outlet and disconnect the antenna (if used). This will prevent damage to the product due to power line surges.
5. If an outside antenna is connected to the product, make sure the antenna is properly grounded so as to provide some protection against voltage surges.

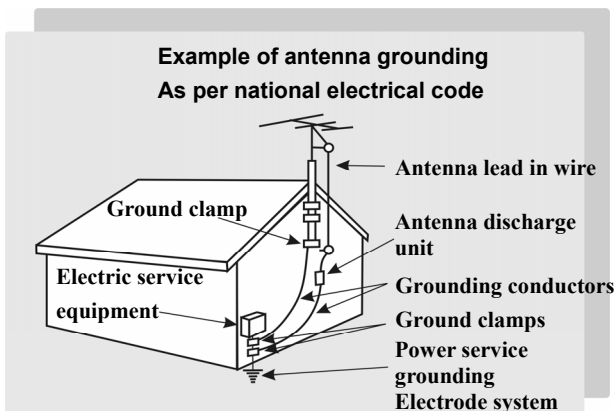

6. Lamp(s) Contain Mercury. Dispose According to Local, State, Federal Laws.

7. Stand: Do not place the product on an unstable cart, stand, tripod or table. Placing the product on an unstable base can cause the product to fall, resulting in serious personal injuries as well as damage to the product. Use only a cart, stand, tripod, bracket or table recommended by the manufacturer or sold with the product. Use only mounting hardware recommended by the manufacturer.



8. Use care when moving the product on a rolling cart. Sudden stops, excessive force and uneven floor surface can cause the product to fall from the cart.

9. Ventilation: The vents and other openings in the cabinet are designed for ventilation. Do not cover or block these vents and openings as insufficient ventilation can cause overheating and/or shorten the life of the product. Do not place the product on a bed, sofa, rug or other similar surfaces since they can block ventilation openings. This product was not designed to operate in an enclosed environment. Don't place the product in an enclosed space such as a bookcase or rack, unless proper ventilation is provided or the manufacturer's instructions are followed.

10. The LCD panel used in this product is made of glass. Therefore, it can break if the product is dropped or struck.

11. During the LCD panel lifespan it is normal for a few pixels to become defective. Non-active pixels may appear on the screen as fixed points of red, blue or green. Refer pixel policy questions to the reseller for further clarification on acceptable loss.

12. An outside antenna system should not be located in the vicinity of overhead power lines or other electrical conduits. When installing an outside antenna, use extreme caution to prevent the antenna from coming into contact with said items, as contact with them may be fatal.

Features

List of Features

Your TV is designed with the latest technology and is a high-performance unit that includes the following special features:

- Multiple input sources including Antenna terminal for Analog / Digital, D-SUB connector, HDMI connector, Composite, S-Video, and Component ports.
- Easy-to-use remote control and on-screen-display (OSD) menu system.
- PIP (picture in picture) mode for displaying multiple sources at the same time on the same screen.
- Built-in 10W dual channel speakers , audio out , and sub-woofer out .
- Fine-tuning control for the sharpest picture possible. (OTA TV viewing only).
- Built-in multi-channel sound decoder for stereo and bilingual broadcasts.
- Automatic channel program for up to 125 channels.
- Automatic sleep timer control from 10 to 120 minutes in 10-minute increments.
- Automatic Power Off feature after 10 minutes without a signal.
- Adjustable picture and sound settings that are stored in the TV's memory.
- Component video input for high definition TV programming (HDTV ready), resolution up to 720p, 1080i.
- Automatic Picture Control (APC) and Aspect Ratio Control (ARC) functions for end user customization of viewing preferences.
- Built-in 3D comb filter and 3D de-interlacing for best possible picture quality.

Ports

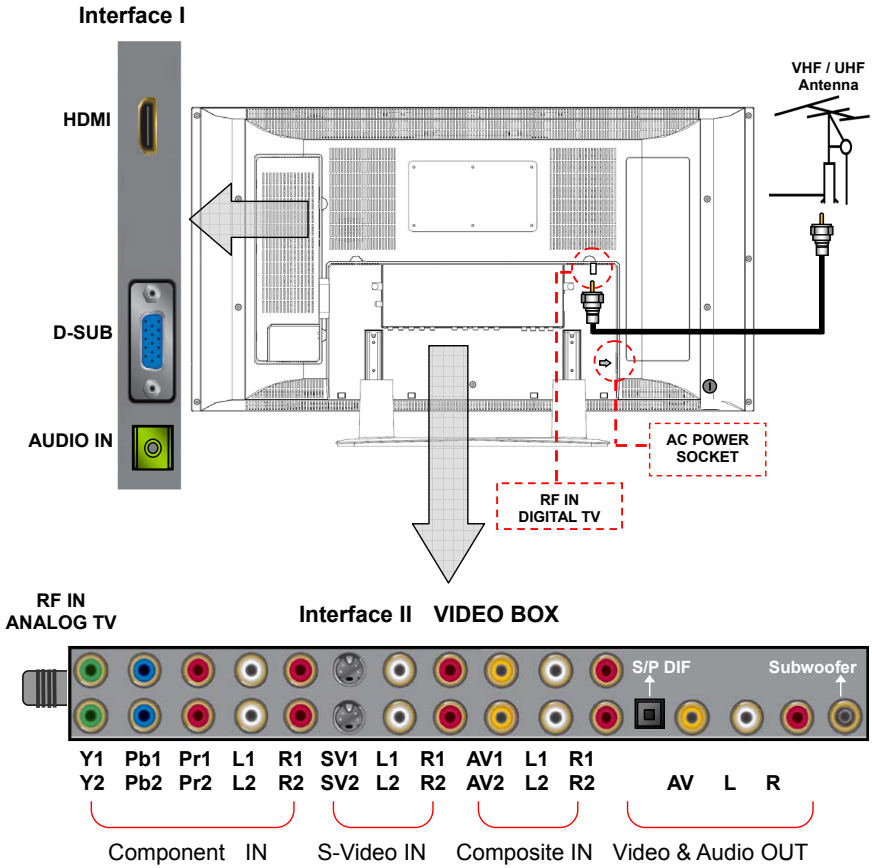

Control Buttons

Main Power Switch

Before operating the LCD display or remote control, users must press **MAIN POWER** switch to **ON**. The **MAIN POWER** switch is located at the bottom-left back of the LCD display (near by Power Inlet).

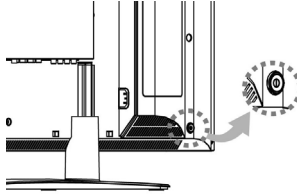

Function Key

These buttons control your TV's basic features, including the on-screen menu. To use advanced features, you must use the remote control.

POWER: turn the LCD-TV on or off.

SOURCE: select the input source (PC, HDMI, AV1, AV2, SV1, SV2, YPBPR1, YPBPR2, TV).

MENU: display the main menu.

CHANNEL (down or up): change the channel.

VOLUME (+/-): increase or decrease the volume.

ARC/ EXIT: select the display output mode (TV source: Panorama, Normal, Full, Zoom1, Zoom2, PC source: Full, Normal).

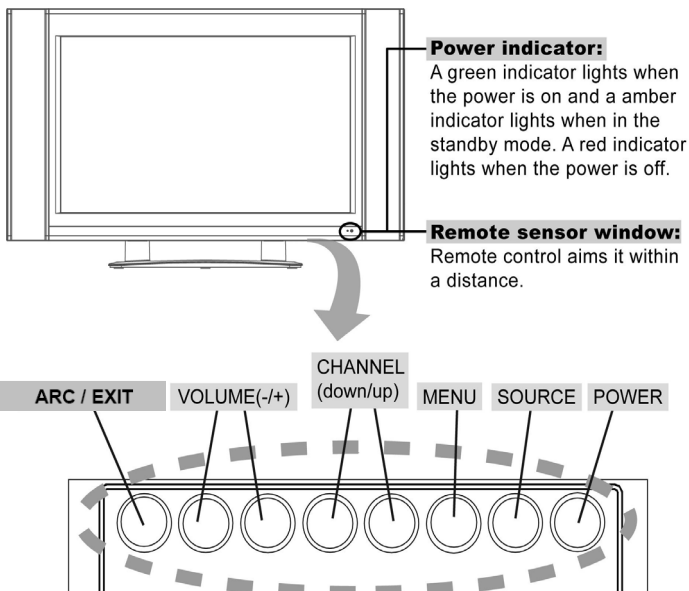

Accessories

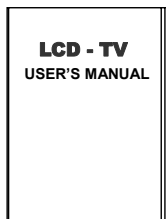

User's manual



Remote control & Batteries (AAA x2)

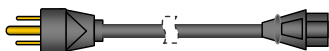

Power Cord

Remote Control

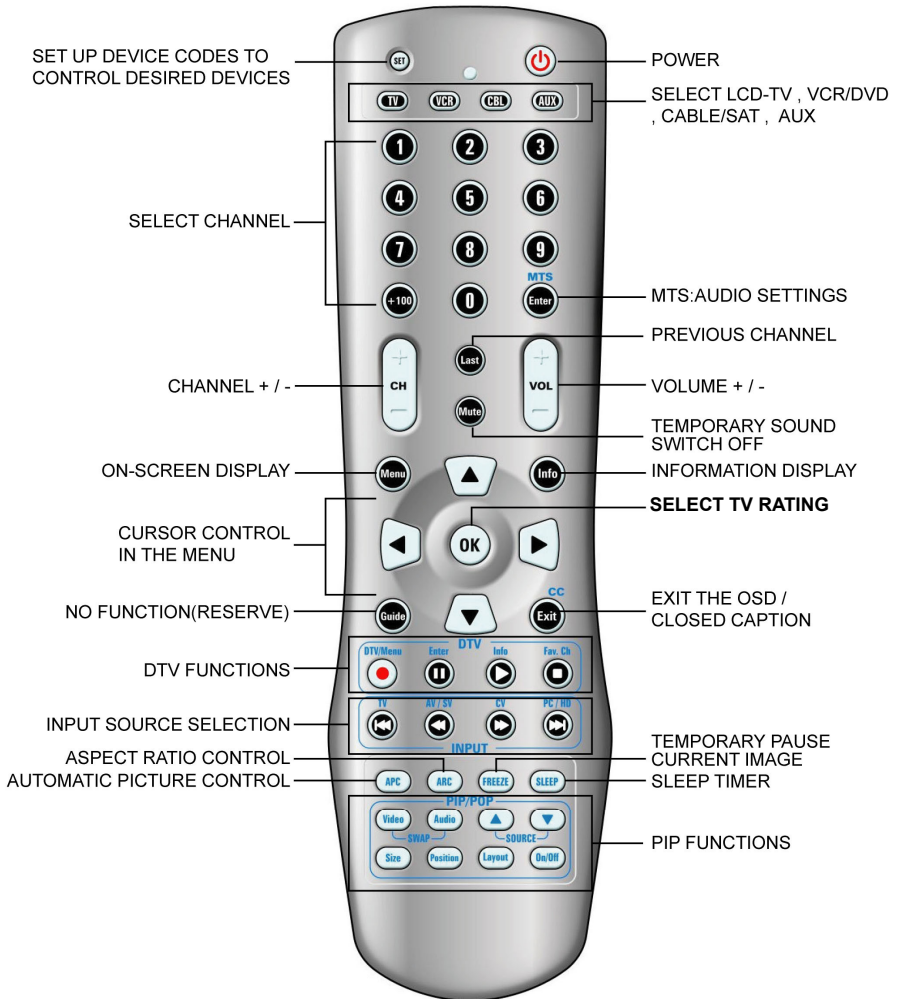

Summary of Control Button

Power control	
POWER button	Turn the TV on or off
Selecting the primary signal source	
TV button	Switch to TV mode
AV/SV button	Switch to AV and S-Video (composite and Y/C mode)
CV button	Switch to CV (component) mode (YPBPR)
PC/HD button	Switch to PC and HDMI mode
Menu Settings	
Menu button	Display the on-screen menu
Exit / CC button	As the Menu is appeared : Exit a menu or sub-menu At the Video Mode: Display the Closed Caption text
UP/DOWN/LEFT/RIGHT	Access menu items
TV Changing Channels	
UP button	Press Up to change the channel
DOWN button	Press Down to change the channel
0-9 ; +100 button	To manually select channels
Last button	Return to the previous viewed channel
Sound Control	
VOL+ button	Increase volume level
VOL- button	Decrease volume level
Mute button	Temporarily turn off audio
MTS button	Cycle through stereo, mono or separate audio program (SAP) multi-channel sound services
PIP Control	
On / Off button	Enable/Disable PIP viewing window
△/▽ button	Select PIP input source: TV→AV1→AV2→SV1→SV2
SIZE button	Toggle PIP window size: Small / Meddle / Large
Audio / Video button	Toggle audio/video source between the primary display and the PIP window
Position button	Move the PIP window position
Layout button	Change the display modes with primary display and the PIP window (ex: PIP / POP)
Other Function	
ARC button (Aspect Ratio Control)	Toggle the picture mode between normal→Zoom1→Full→Panorama→Zoom2. In PC mode, only has Full and Normal
APC button (Automatic Picture Control)	Toggle screen luminosity between STANDARD, BRIGHT, MOVIE ,and MANUAL modes.
SLEEP button	Select a pre-set time for automatic power down.
FREEZE button	Temporary pause current image
Guide button	No function
DTV Control	
DTV/ Menu	Switch to Digital TV mode / Display DTV MENU
Enter	DTV setting confirmation
Info	Display current channel/Input source/signal format/DTV information
Fav. CH	DTV favorite channel list
Other Devices Function	
TV	Control this LCD-TV (default).
VCR	Control DVD player or VCR.
CBL	Control Cable Converter or Satellite.
AUX	Control Audio Amplifier.
SET	Press to program the remote control to provide control of other devices.

Connections & Applications

* How to connecting Video Device via HDMI ?

This can be applied only if there is the HDMI Output connector on the external device.

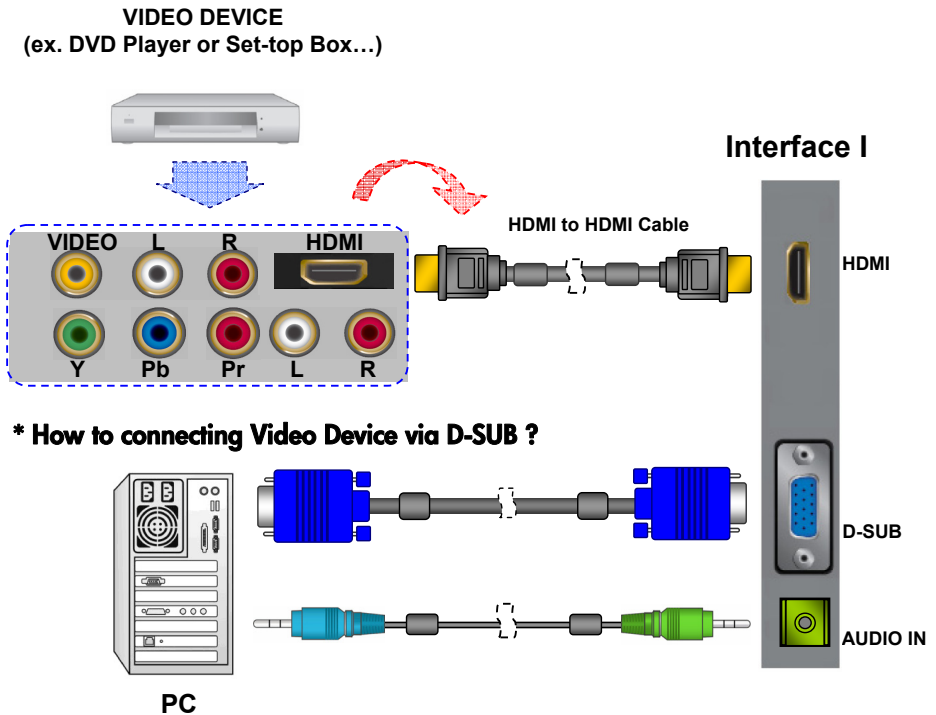

* How to connecting Video Device via D-SUB ?

Note: No sound connector is needed for an HDMI to HDMI connection.

* How to connecting Video Device via DVI –HDMI ?

This can be applied only if there is the HDMI Output connector on the external device.

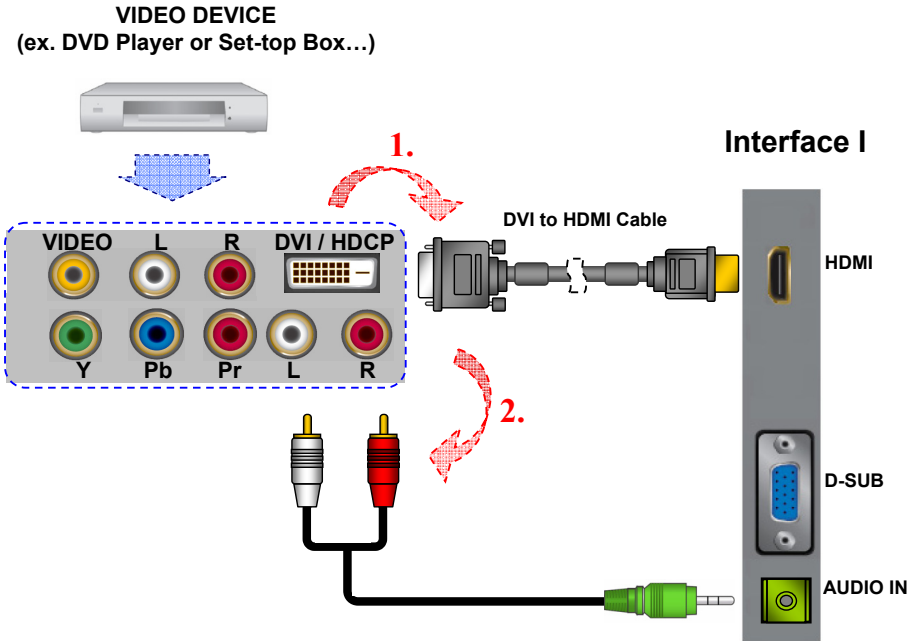

1. Connect a DVI-to-HDMI cable or DVI-HDMI adapter between the HDMI/DVI connector On the TV and the DVI connector on the DVD player/ Set-top box.
2. Connect an audio cable between the PC AUDIO IN jack on the TV and AUDIO OUT jack On the DVD player/ Set-top box.

*** How to connecting Video Device via general cable ?**

Interface II VIDEO BOX

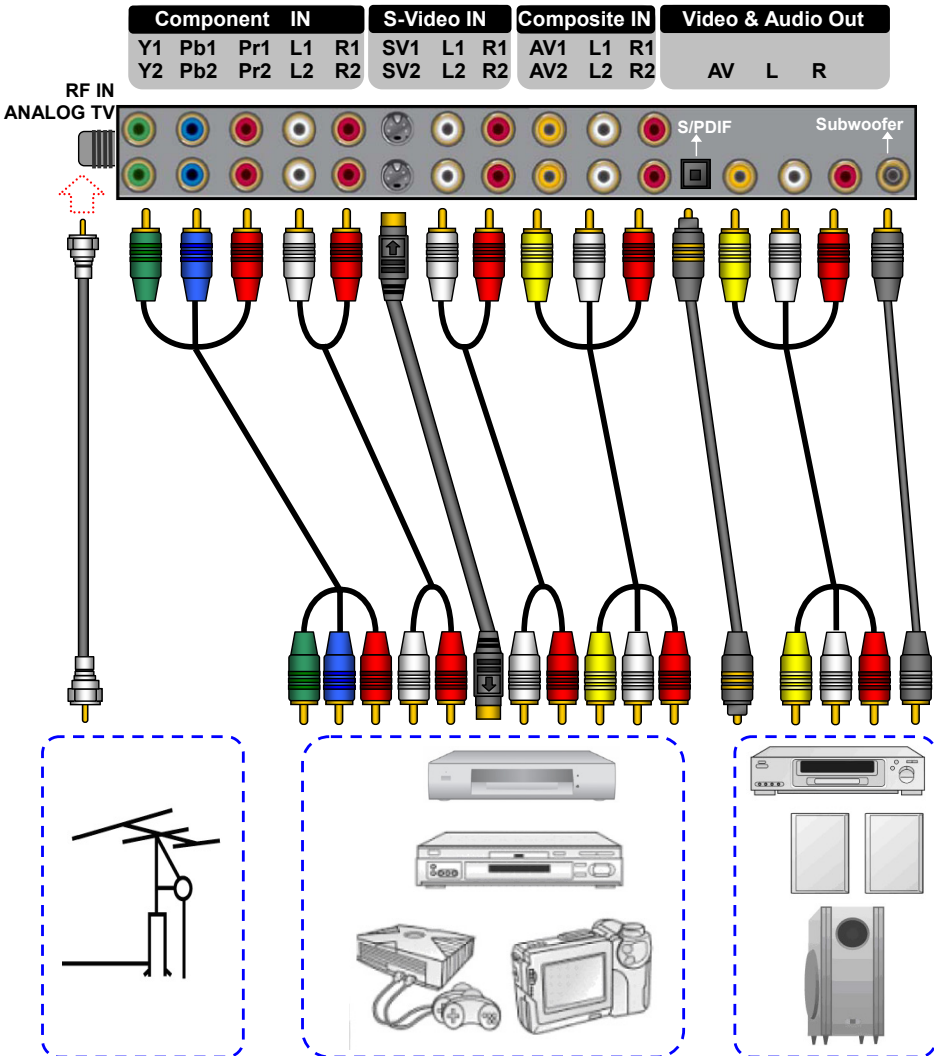

This TV accept different Video Input, if video device has a connector with better quality, please connect the better one. The sequence of video quality is Component, S-video, Video from the best quality to the normal one.

Controls & Adjustment

A. General Adjustment

Turning the LCD TV On and Off

Plug the power cable into the AC-in socket located on the left rear of the LCD TV. Plug the other end into an electrical socket. Press the main **POWER** button located on the back of the left speaker. Once the main power button is engaged, press the power button on the remote control or use the power button located within the control buttons panel on underside of the TV to turn the TV on.

The power status light found in the lower right hand corner of the TV indicates the following:

Power On (TV, Video mode)	---	Green light °
Power off	---	Red light °
PC mode	---	Green light °
Power Saving (PC mode)	---	Amber light °

Note: If “NO SIGNAL” appears for 10 minutes under TV or Video mode, the set will automatically power off.

Viewing the Menus and On-Screen Displays



1. With the **Power** on, press the **Menu** Button.
The main menu appears on the screen.

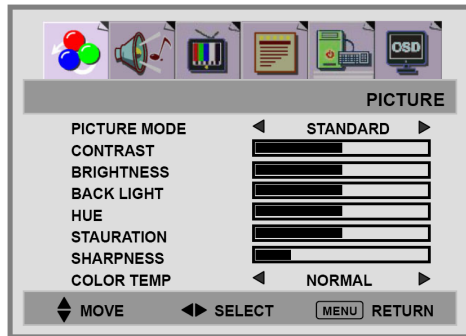

2. Press the ◀ or ▶ button to select one of the menu options. Then press the ▲ or ▼ button to access the sub-menu.
3. Press the ◀ or ▶ button to make adjustments.
4. Press the **Exit** button to exit from the menu or Press the **Menu** to return to the previous screen.

Switching PC/HD / Video / S-Video/ TV / Component Modes

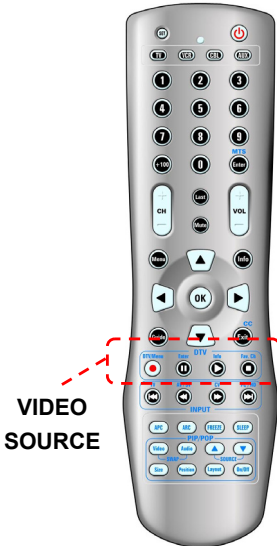

VIDEO
SOURCE

1. Turn on the power.
2. Select an input source as described below:

TV	button	to switch to TV mode.
PC/HD	button	to switch to PC and HDMI mode. (Analog or Digital)
AV/SV	button	to switch to AV and S-Video mode.
CV	button	to switch to YPBPR mode (Component).
DTV/Menu	button	to switch to DTV mode (ATSC).

Switching Language Modes

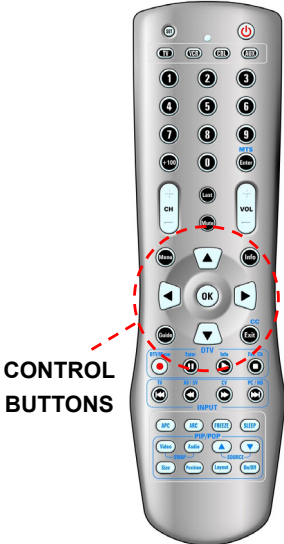

CONTROL
BUTTONS

1. Press the **Menu** button to display **OSD** from the main menu.
2. Press the \triangle or ∇ button to access **LANGUAGE** options.

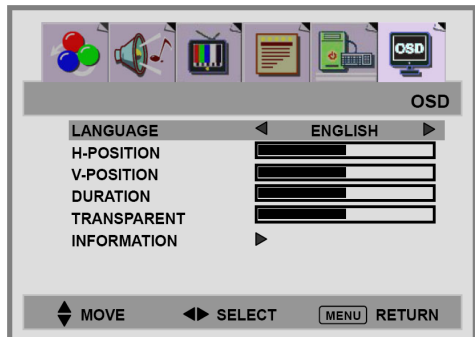

3. Press the \triangleleft or \triangleright button to select the desired language mode.
4. Press the **Exit** button to exit from the menu or press the **Menu** to return to the previous screen.

Setting the Sleep Timer



You can set the Sleep Timer to automatically turn off the LCD TV.

1. Press the **SLEEP** button to display the Sleep Timer screen.
2. Press the **SLEEP** button to set the sleep timer (in 10 minute increments).

10 min → 20 min → 30 min → 40 min → 50 min
 → 60 min → 70 min → 80min → 90min → 100min
 → 110min → 120min → OFF

Note:

1. The Sleep Timer screen automatically disappears in 10 seconds.
2. The TV will automatically power off if no signal is detected for 10 minutes.

Adjusting the Volume



Using Volume Control

Press the **VOL (+)** or **VOL (-)** button to increase or decrease the volume level.

Using Mute

At any time, you can temporarily turn off the sound using the **Mute** button.

1. Press the **Mute** button and the sound turns off. A MUTE text will appear on the screen denoting the sound is muted.
2. Press **Mute** again or the **VOL (+)** or **VOL (-)** button to return audio back to the previous level.

B. PC Mode Adjustment

Adjusting the Contrast & Black light Settings

Each viewing mode supports separate adjustments for black light and contrast levels. PC mode is best viewed with middle black light and contrast levels as compared to other modes.

Adjusting PC Settings



CONTROL
BUTTONS

ANALOG INPUT

1. Press the **PC / HD** button to set the main display to PC mode. Press the **Menu** button to display **PC** from the main menu.
2. Press the \triangle or ∇ button to access **PC** sub-menu.
3. Press the \triangleleft or \triangleright button to select the settings for adjustment.
4. Press the **Exit** button to exit from the menu or press the **Menu** to return to the previous screen.

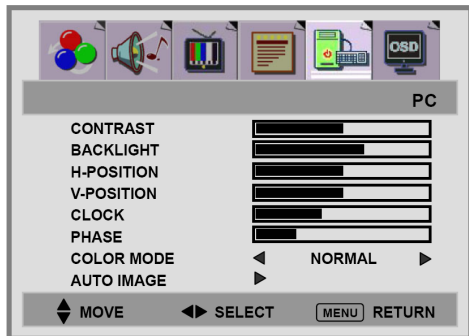

Adjusting Sound Settings

1. Press the **Menu** button to display **SOUND** from the main menu.

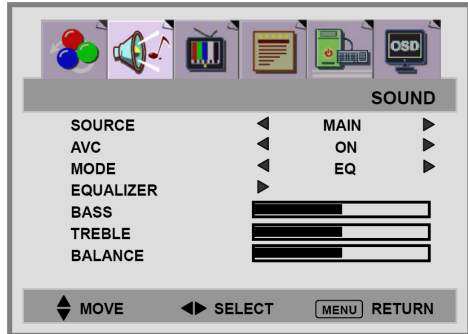
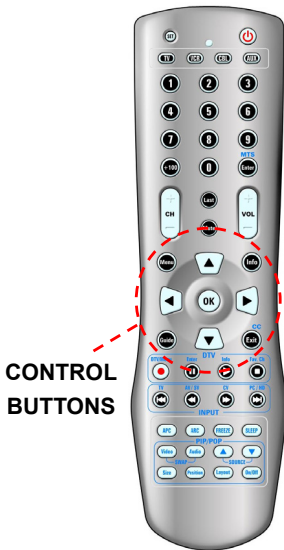

2. Press the \triangle or ∇ button to access **SOUND** sub-menu.
3. Press the \triangleleft or \triangleright button to select the settings.
4. Press the **Exit** button to exit from the menu or press the **Menu** to return to the previous screen.

AVC:

You can set AVC(Auto Volume Control) options to ON or OFF.

- a. ON – For general use, like commercial advertisement, AVC can avoid the sound turns up or down suddenly.

OFF– For special sound effect, like opera or symphony, volume can be performed in accordance with the original sound level.

EQUALIZER:

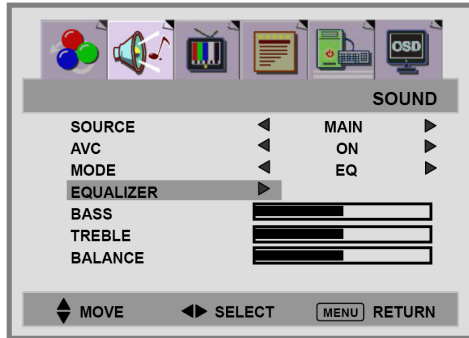
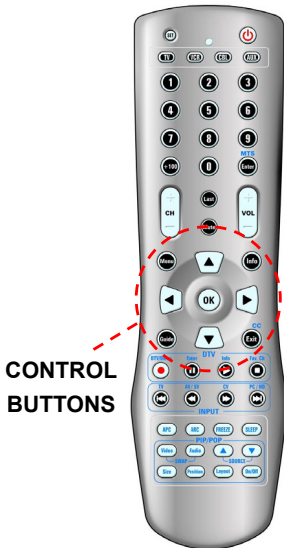

- a. Press the \triangle or ∇ button to access EQUALIZER option.
- b. Press the \triangleright button to enter EQUALIZER menu.
- c. There are 6 EQUALIZER modes available:
 { **MANUAL** }, { **POP** }, { **JAZZ** }
 { **VOICE** }, { **ROCK** }, { **CLASSIC** }
- d. Selecting the **MANUAL** pre-set allows you to manually adjust the frequency response.
- e. Settings for POP, JAZZ, VOICE, ROCK and CLASSIC are pre-configured. You can't change these settings. The frequency response are as below:

MANUAL:

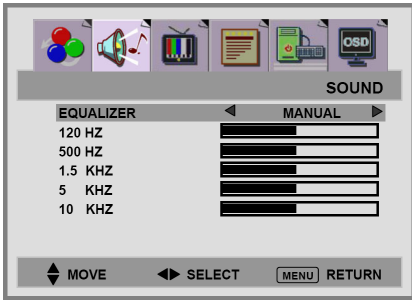

POP:

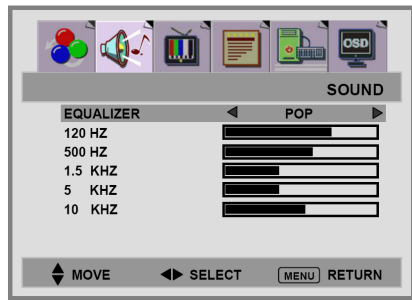

JAZZ:

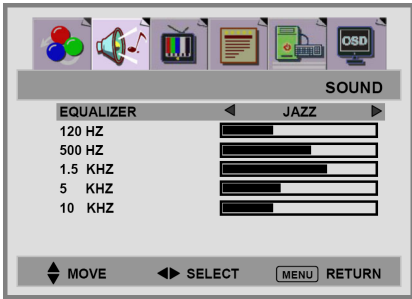

VOICE:

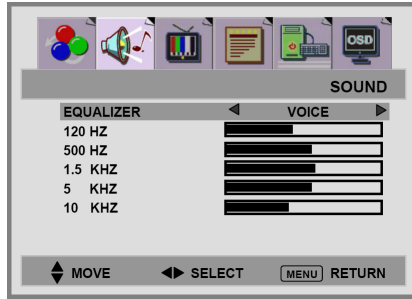

ROCK:

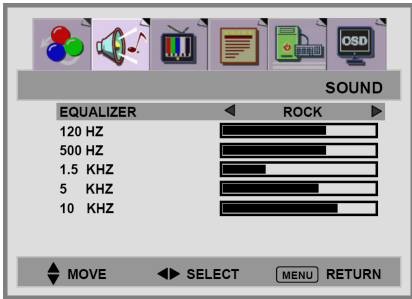

CLASSIC:

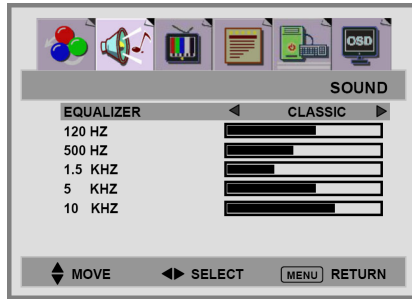

Viewing Picture-in-Picture (PIP)

PIP: While viewing content on the main display, you have the option to select a secondary signal as a sub-display in a picture in picture. This feature allows you to watch two video sources simultaneously.

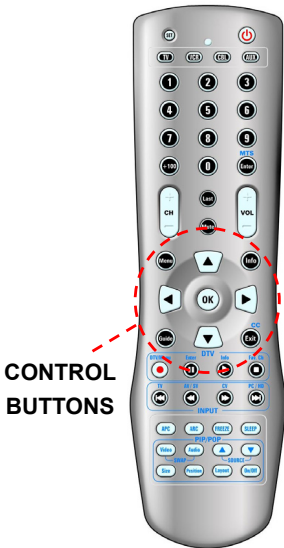

**CONTROL
BUTTONS**

Activating Picture-in-Picture

1. Press the **Menu** button to display FUNCTION From the main menu.
2. Press the \triangle or ∇ button to access FUNCTION sub-menu.
3. Press the ∇ button to select MULTI MODE option.
4. Press the \triangleleft or \triangleright button to select the PIP or POP mode.

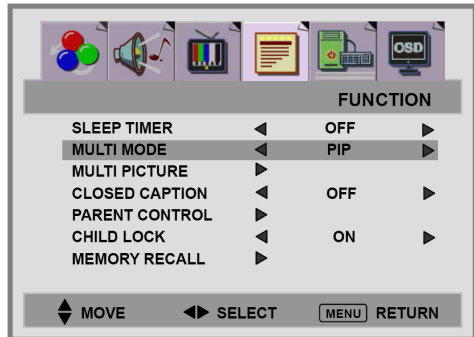

- OFF: Only show the primary source (No PIP/POP).
- PIP: Show PIP in a window.

Note: Used the Remote Control to Enable the PIP function

1. Press the **PIP ON/OFF** button.
2. Press the \triangle or ∇ button to select the PIP source.



- POP: Show PIP side by side with the main source.

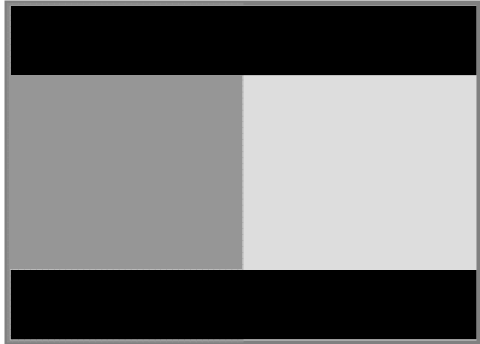

Note: Numbers of Video source cannot be displayed at the same time.(refer to the Table on page25)

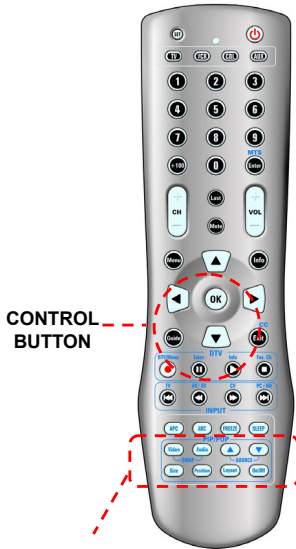

CONTROL
BUTTON

PIP Function
Control Key

Note: Used the Remote Control to Enable the PIP function

1. Press the **PIP ON/OFF** button.
2. Press the \triangle or ∇ button to select the PIP source.

5. Press the \triangle or ∇ and \triangleright button to access **MULTI PICTURE** option.

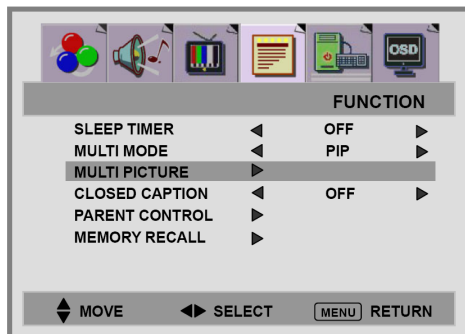

6. Press the \triangle or ∇ button to select the settings for adjustment.

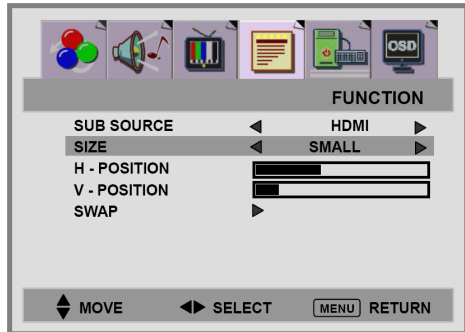

- SUB SOURCE : You can select PIP source.
- SIZE : Three different PIP sizes. (SMALL) , (MIDDLE) , (LARGE)
- H-POSITION / V-POSITION : Press the \blacktriangleleft / \blacktriangleright button can make PIP window move from corner to corner on the TV screen.
- SWAP: To exchange the display of main source and sub-source.

● Table

Sub Main	PC	HDMI	YPBPR 1	YPBPR 2	DTV	SV1	SV2	AV1	AV2	TV
PC	X	X	X	X	X	O	O	O	O	O
HDMI	X	X	X	X	X	O	O	O	O	O
YPBPR 1	X	X	X	X	X	O	O	O	O	O
YPBPR 2	X	X	X	X	X	O	O	O	O	O
DTV	X	X	X	X	X	O	O	O	O	O
SV1	O	O	O	O	O	X	X	X	X	X
SV2	O	O	O	O	O	X	X	X	X	X
AV1	O	O	O	O	O	X	X	X	X	X
AV2	O	O	O	O	O	X	X	X	X	X
TV	O	O	O	O	O	X	X	X	X	X

C. General TV Mode Adjustment

Adjusting the TV settings

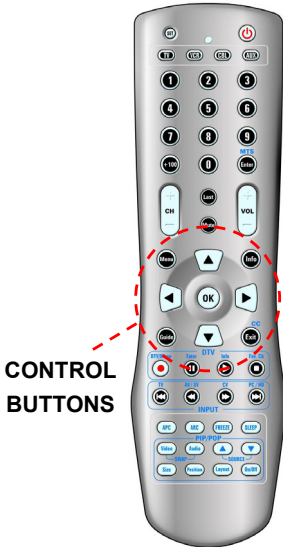

1. Press the TV button to set the main display to TV mode. Press the **Menu** button to display **TV CHANNEL** from the main menu.

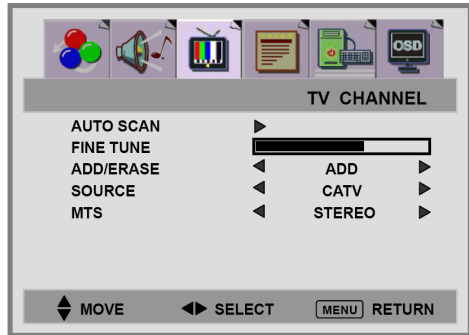

Sound Options

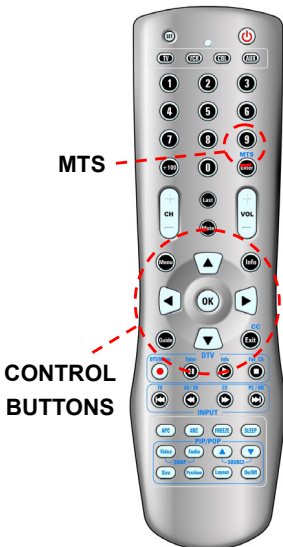

Choosing a Multi-Channel Sound (MTS) Soundtrack

Depending on the particular program being broadcast, you can listen to Stereo, Mono or a Separate Audio Program. (SAP audio is usually a foreign-language translation).

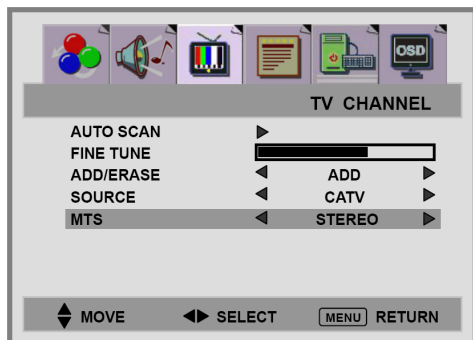

Adjusting Picture Settings

1. Press the **Menu** button to display **PICTURE** from the main menu. Then press the \triangle or ∇ button to select **PICTURE MODE** option.

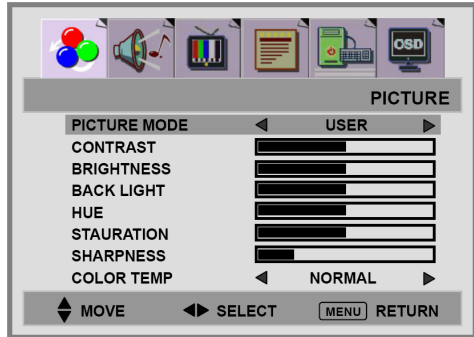
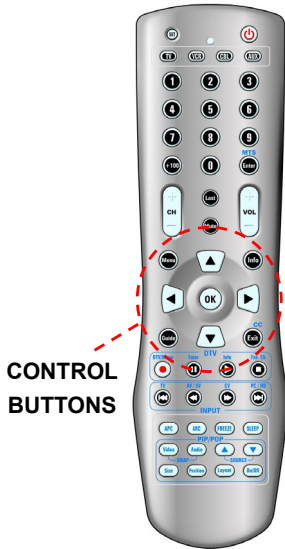

2. Press the \triangleleft or \triangleright button to enter the **USER** menu.
3. Press the \triangle or ∇ button to select the desired item. Then press the \triangleleft or \triangleright button to adjust ranges from minimum to maximum
4. Press the **Menu** button to return to the previous screen or exit from the sub-menu.

Memorizing Channels

Your TV can memorize and store all of the available channels for both standard broadcast (antenna) and cable channels. After the available channels are memorized press the \triangle or ∇ button to view stored channels. You can also view any channel (even non-memorized) by directly entering the channel digits via the remote control.

There are three steps to memorizing channels:

1. Selecting a TV signal input source
2. Memorizing the available channels (automatically)
3. Adding/Erasing channels (manually)

Selecting the TV Signal Source

Before your television can begin to memorize available channels, you must specify the type of signal source that is connected to the TV (i.e., an antenna or a cable system).

1. Press the TV button to set the main display to TV mode. Press the **Menu** button to display TV from the main menu.
2. Press the \triangle or ∇ button to select the **SOURCE** option.
3. Press the \triangleleft or \triangleright button to select between Antenna, AIR , CATV , HRC , IRC source signals.

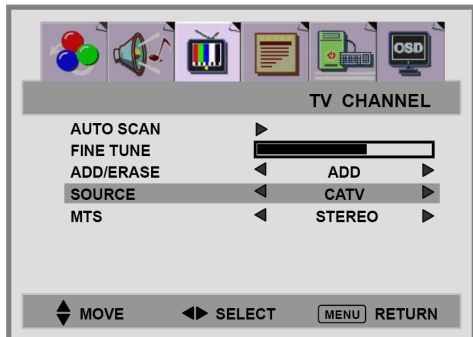
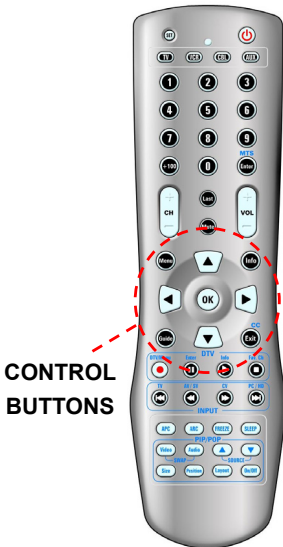

Storing Channels (Automatic Method)

1. Press the **Menu** bottom to display **TV CHANNEL** from the main menu .Then press the ∇ button to select the **AUTO SCAN** option.
2. Press the \triangleright button to run through all of the available channels and store them in memory.
It may take a few minutes to acquire the available channels.

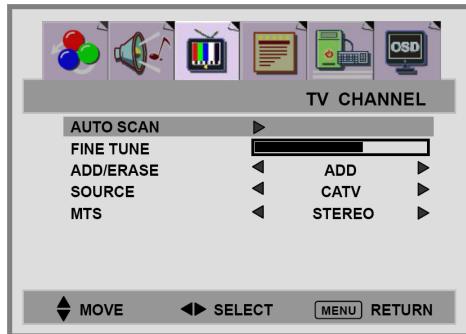
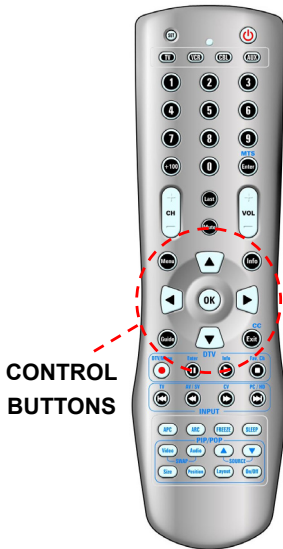

Adding and Erasing Channels (Manual Method)

1. Press the **Menu** bottom to display **TV CHANNEL** from the main menu .
2. Press the ∇ button to select the **ADD/ERASE** option.

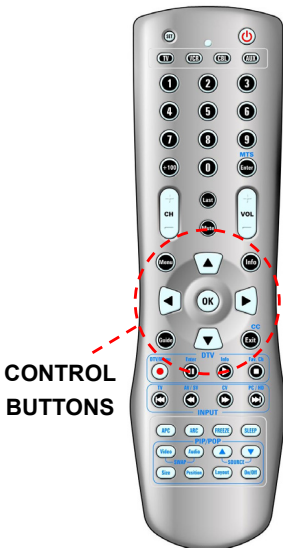

Changing Channels

This LCD TV tuner provides the ability to display up to 125 channels (1 to 125).

To select a channel, enter the channel number using 1 to 3 digit numbers.

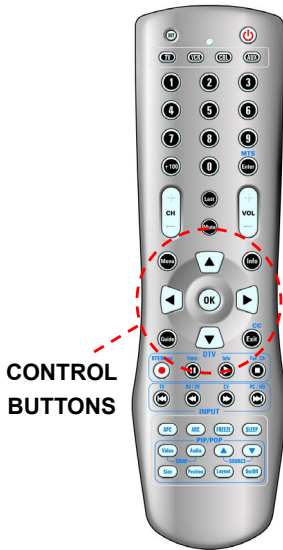

Using the Channel Buttons

1. Press the *channel (+)* or *channel (-)* button to change channels.

When you press the *channel (+)* or *channel (-)* button, the channels move up or down in sequence. You will see all the channels that have been memorized, (the channels must be memorized). You will not see channels that were either erased or not memorized.

Directly Accessing Channels

Enter the channel number using the numeric buttons to go directly to the channel desired.

For example, to go to channel 27, press “2” then “7”. The TV will change to channel 27.

Using the direct access method you can access any available channel including non-memorized and erased channels. To select a channel over 100, press the +100 button. (For example, to go to channel 122, press “+100”, then “2”, and then “2”).

Using Parent Control

The **Parent Control** feature allows you to block channels from being viewed unless an unlock PIN code is correctly entered.

Before Parent Control restrictions can be utilized, you must first create a PIN number.

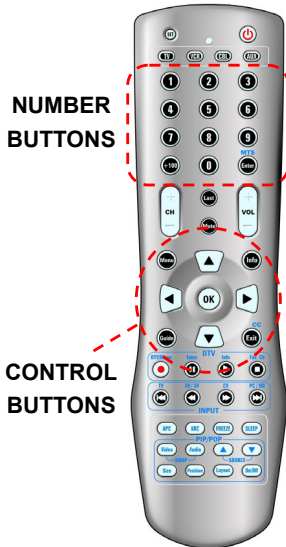

1. Press the **TV** button .
2. Press the **Menu** button to display **FUNCTION** from the main menu.
3. Press the ▾ button to select the **PARENT CONTROL** option.

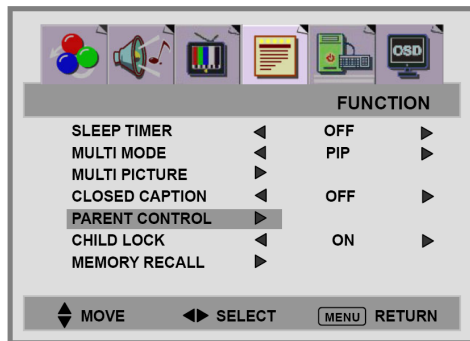

4. Press the ▷ button to enter the **BLOCKING PASSWORD** menu.

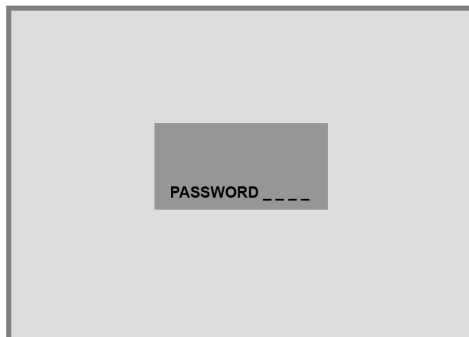

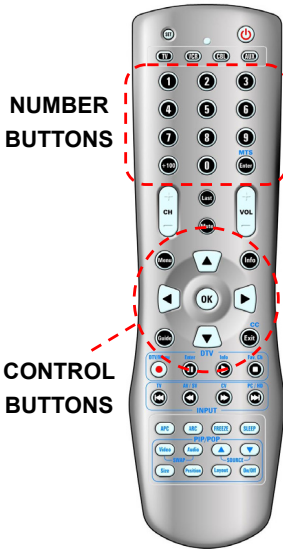

5. Enter your 4-digit PIN when you have finished entering the PIN. If the PIN is not correct, main menu will appear again.

NOTE: The factory default PIN code is 0000.

6. After entering a valid PIN number, the all of Parent Control sub options will appear. Press the \triangle or ∇ button to select the sub-menu.

Setting Up Your Personal ID Number (PIN)

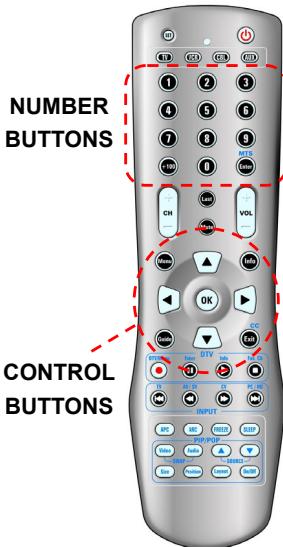

1. Press the \triangle or ∇ button to select the **CHANGE PASSWORD**.

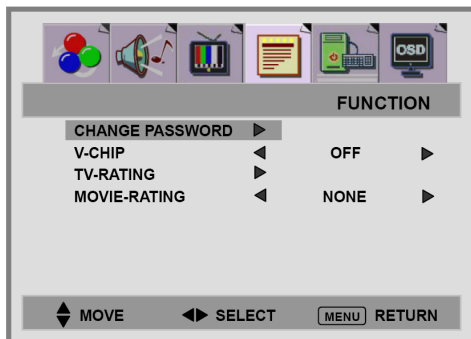

2. Press the  button to enter the **BLOCKING PASSWORD** menu.

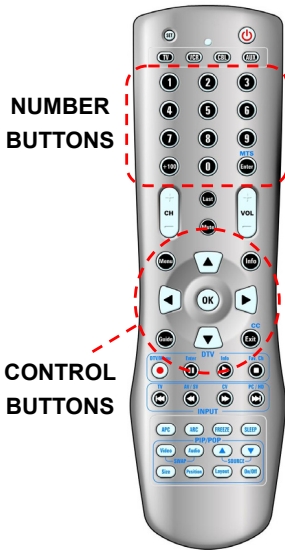

3. Enter your new 4-digit PIN XXXX, and the **BLOCKING CONFIRM** menu will be on the screen.

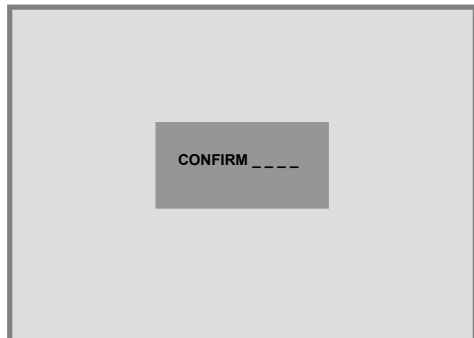

4. Enter the 4-digit PIN the same as step3 XXXX again, IF the PIN is correct, **“OK”** will be on the screen.

If the PIN is not correct, main menu will appear again.



- When you have finished entering the PIN, new setting to be operation.

How to Enable / Disable Parent Control

Under the **PARENT CONTROL** sub-options:

- Press the \triangle or ∇ button to select the **V-CHIP**.

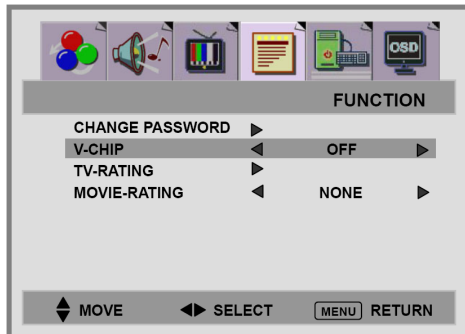

- Press the \triangleleft or \triangleright button to select the V-CHIP ON or OFF.
- Press the \triangle or ∇ button to select **TV-RATING**.

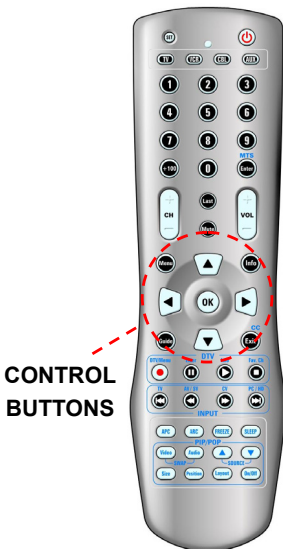

**CONTROL
BUTTONS**

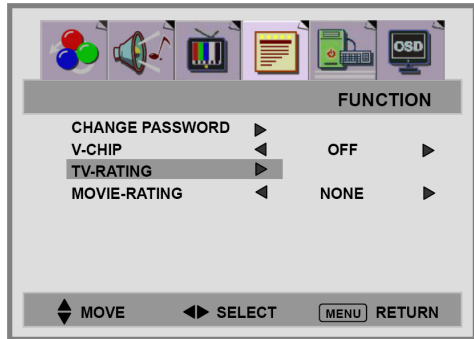

4. Press the \triangleright button to enter the **TV-RATING**, Rating menu will appear.

TV-Y	Young children
TV-Y7	Children 7 and over

TV-G	General audience
TV-PG	Parental guidance
TV-14	Viewers 14 and over
TV-MA	Mature audience
ALL :	
FV :	Fantasy violence
V :	Violence
S :	Sexual situation
L :	Adult language
D :	Sexual suggestive dialog

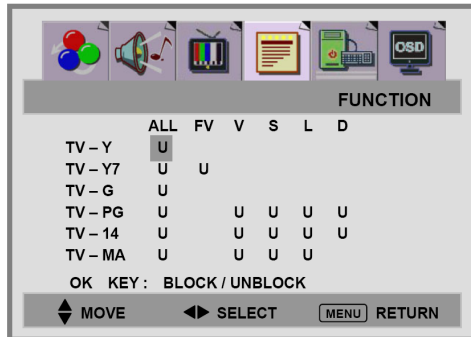

5. Press the **OK** key to select Content BLOCK or UNBLOCK.
6. Press the **Exit** or **Menu** buttons to jump-out the setting menu. TV-Rating function is operation.

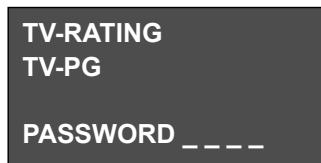

If the channel is set to a restricted channel, the parent control will automatically block it, and the BLOCK menu will appear.

Setting up restrictions using the "BLOCKING MOVIE" function.

The **MOVIE-RATING** option utilizes the Motion Picture Association of America (MPAA) ratings system for determining blocked programming. When the parent control lock is enabled, the TV will automatically block any programs that are coded with objectionable ratings.

Under the **PARENT CONTROL** sub-options:

1. Press the \triangle or ∇ button to select **MOVIE-RATING**.

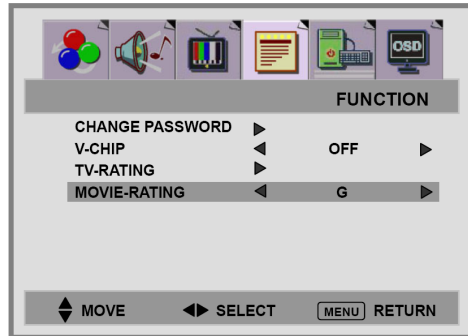
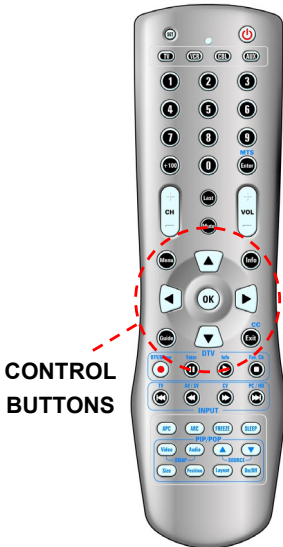

2. Press the \triangleleft or \triangleright buttons to select the rating level.
3. Press the *Exit* or *Menu* buttons to jump-out the setting menu. MOVIE-Rating function is operation.

If you want to disable the Parent Control ,Press the \triangleleft or \triangleright button to select the V-CHIP item to **OFF**. All locked channels will be released automatically.

MOVIE-RATING
R

PASSWORD _ _ _ _

If the channel is set to a restricted channel, the parent control will automatically block it, and the BLOCK menu will appear:

G : General audience (no restrictions).
PG : Parental guidance suggested.
PG13 : Parents strongly cautioned.
R : Restricted. Children under 17 should be accompanied by an adult.
NC17 : Adults only under 17.
X : No Children

Child Lock



**CONTROL
BUTTONS**

1. Press the **TV** button .
2. Press the **Menu** button to display **FUNCTION** from the main menu.
3. Press the ∇ button to select the **CHILD LOCK** option.
4. Press the \triangleleft or \triangleright buttons to enable / disable the function key of front cover.

[ON]: Function key is locked.

[OFF]: Function key is active.

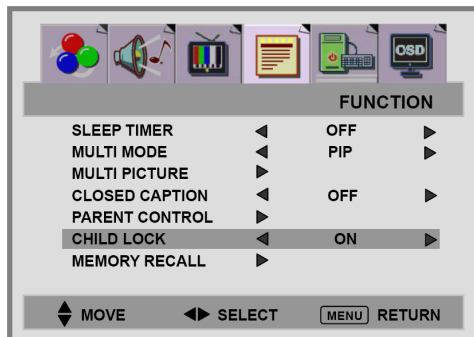

NOTE :You can use **MEMORY RECALL** to reset to factory settings.

Viewing Closed Captions

This LCD TV has the ability to decode and display closed caption content if supported by the program. These captions are usually used for the hearing impaired or for foreign language translations. Most VCR's can record the closed caption signal from television programs. Most pre-recorded commercial videotapes also provide closed captioning as well. Refer to the closed caption symbol within your television programming guide and on the videotape packaging in order to properly configure the closed captioning function:

Note: The Caption feature does not work with Component Video / PC / HDMI input source.

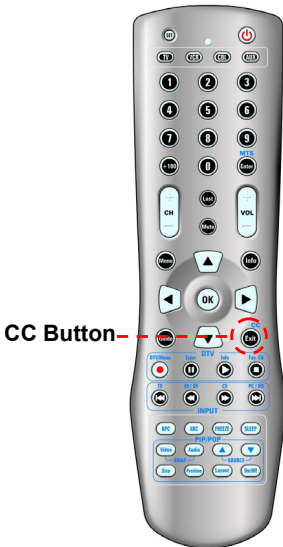

CC Button

You can press the *Exit* / *CC* button on remote control to select this function.

1. Press the TV button to set the main display to TV mode. Press the *Menu* button to display **FUNCTION** from the main menu .
2. Press the \triangle or ∇ button to select **CLOSED CAPTION** option.

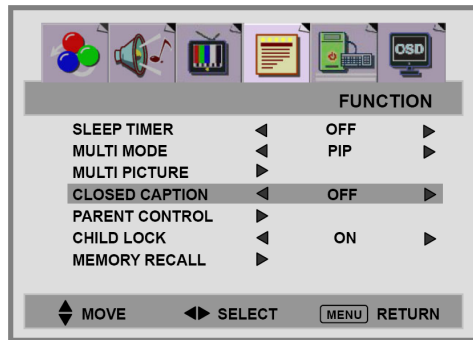

3. Press the \triangleleft or \triangleright button to select between closed captioning modes **CC1**, **CC2**, **CC3**, **CC4**, **TEXT1**, **TEXT2**, **TEXT3**, and **TEXT4**. If you don't want to display captions, set the caption mode to "OFF".
4. Press the *Exit* or *Menu* buttons to jump-out the setting menu. Closed-Caption function is operation.

D. DTV System

Channel Scan

Before you can use any of the channel buttons (*CH +/-*, *Fav.Ch*), the available channels must first be scanned and memorized.

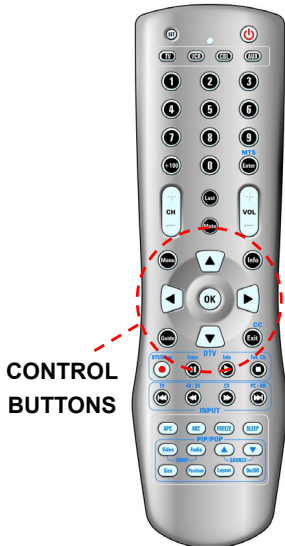

Initial Screen

The first time the receiver is powered on, you will see the message as below.



Press [Menu] key and then select channel to run Auto/Manual Scan.

As the signal is weak or the signal is not received, you will see the message as below.



Bad or No Signal.

1. Press the *Menu* button to display **DTV-CHANNEL** from the main menu. Then you will see the **DTV-CHANNEL** sub-menu.

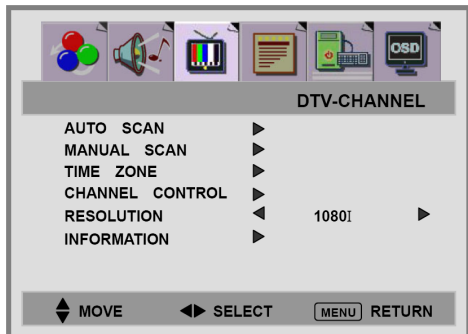

Auto Scan

To automatically scan your channels, follow these steps:

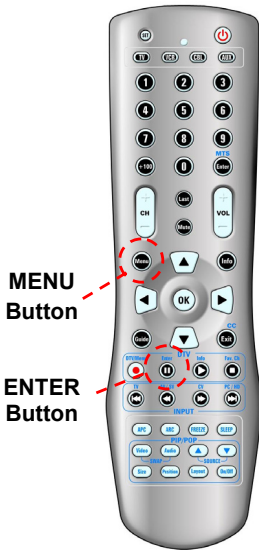

1. Press the **Menu** button to display **DTV-CHANNEL** from the main menu, and then press the \triangle or ∇ button to select **AUTO SCAN** option.

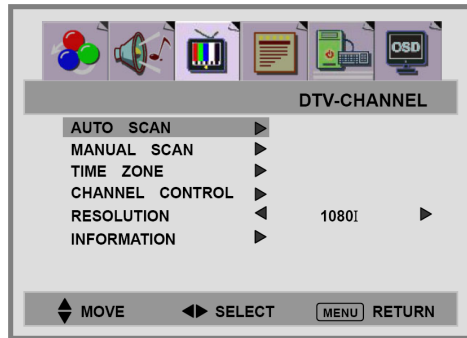

2. Press the \triangleleft or \triangleright button to enter the Auto Scan menu.

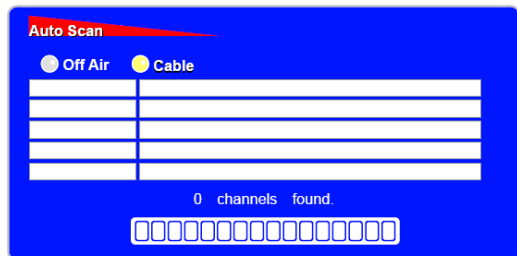
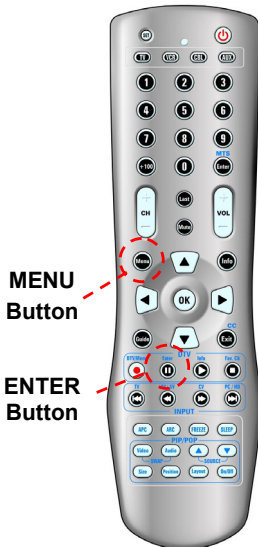

3. Press the Enter to search channel.

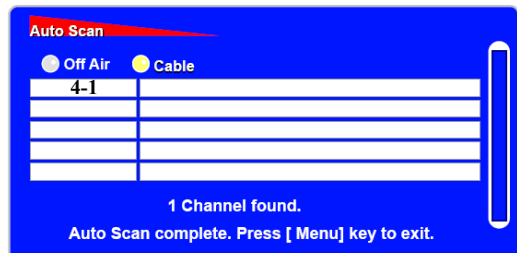

- Once the digital TV signal is scanned, the channel number and the program name are shown on the “Scan List”.
- No channel is found.
You will see the message as below:

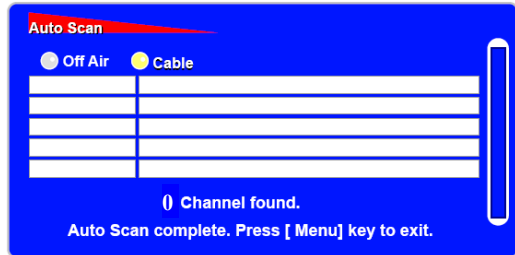

- Press the **Menu** button to exit the screen.

Manual Scan

You can add channels manually if they aren't detected by the Auto Scan utility using the following steps:

1. Press the **Menu** button to display **DTV-CANNEL** from the main menu.

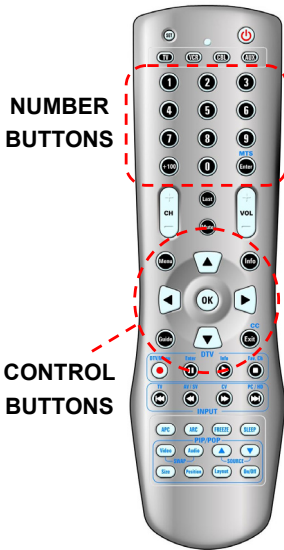
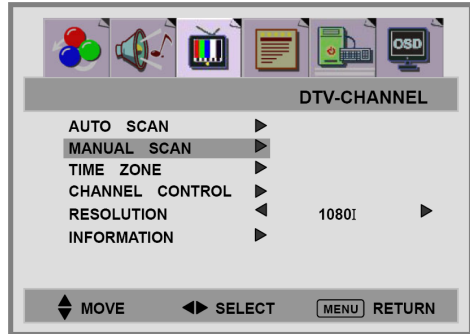

2. Press the **△** or **▽** button to select the **MANUAL SCAN** option, and then press the **▷** button to enter the Manual Scan menu.

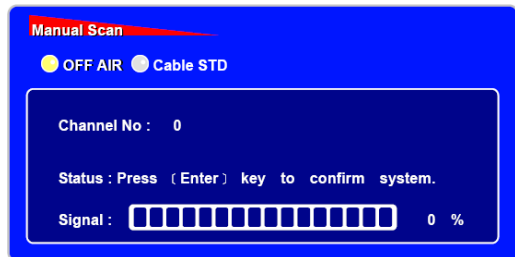

3. Press the **Enter** button when the messages "press [Enter] key to confirm system." are shown then insert the channel number.

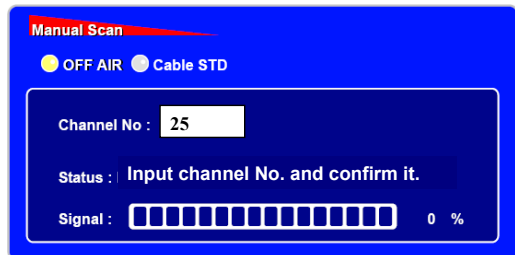

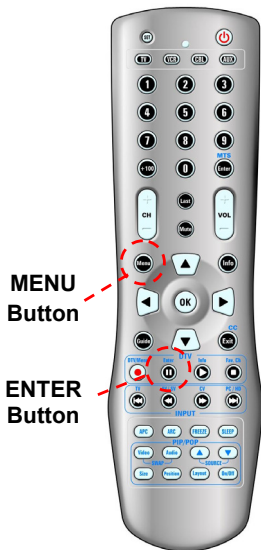

- If the ATSC signal is found and locked, you will see the Status message "Add No.XX 8VSB channel success". Press *Exit* or *Menu* to leave the menu and watch the program, or to scan other channels.

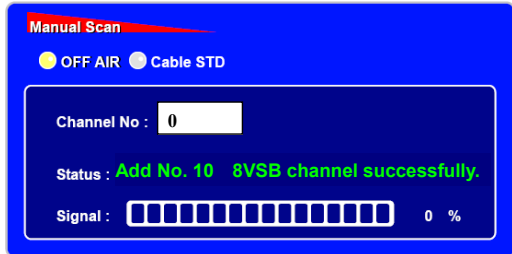

- If the signal is not locked, you will see a "no channel" message. You can scan the signal again or refer to the signal level bar "Signal" for aligning the direction of the antenna to improve the signal.
- When the signal is locked you can check the signal level.

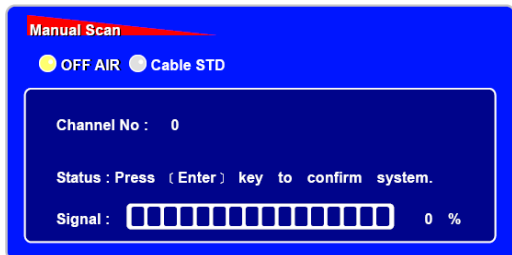

- Press the *Exit* button to return to the main menu or press the *Menu* button to exit the menu system.

Time Zone

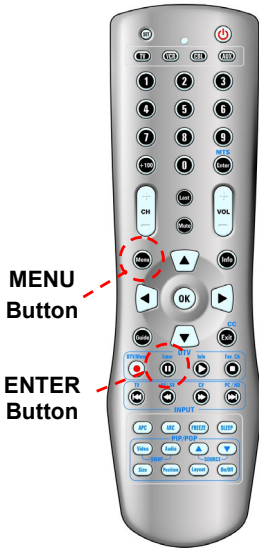

1. Press the **Menu** button to display **DTV-CHANNEL** from the main menu.
2. Press the \triangle or ∇ button to select **TIME ZONE** option.

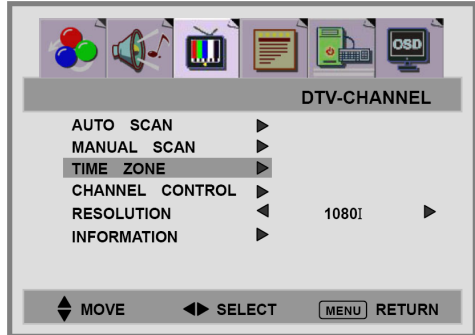

3. Press the \triangleright button to enter the **TIME ZONE** settings.



4. Press the **Enter** button to highlight the input column, and then press \triangleleft or \triangleright buttons to change the time zone 30 minutes at a time.
5. Press the **Menu** or **Exit** buttons to exit the menu system.

If you are receiving a digital signal, the Receivers time will be set automatically.

Channel Control

Change Passwords

1. Press the **Menu** button to display **DTV-CHANNEL** from the main menu.
2. Press the \triangle or ∇ button to select **CHANNEL CONTROL** option.



**CONTROL
BUTTONS**

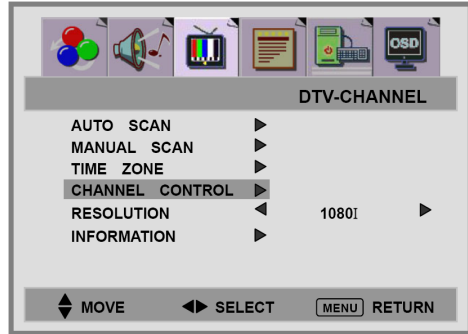

3. Press \triangleright button to enter the sub-menu.

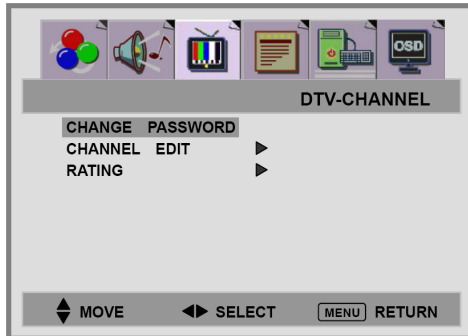

4. Press the  button to enter the **PASSWORD** menu.

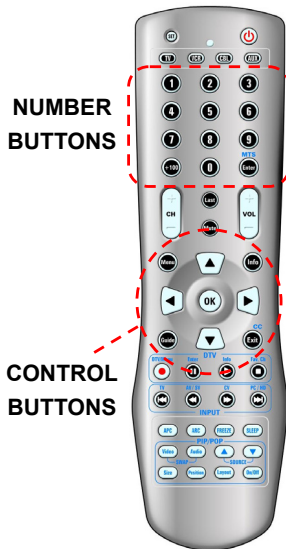

5. Enter your new 4-digit PIN twice. If the PIN is not correct, main menu will appear again.
6. when you have finished entering the PIN, new setting to be operation.

Edit Favorite Channel

You can block access to channels or add them to your favorites list using the following steps:

Under the **CHANNEL CONTROL** options:

1. Press the \triangle or ∇ button to select

CHANNEL EDIT item.

CONTROL
BUTTONS

Fav. CH
Button

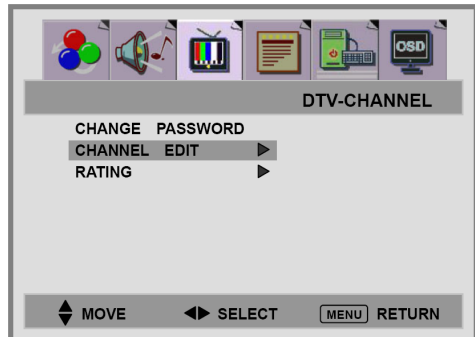

2. Press the \triangleright button to enter the **CHANNEL EDIT** menu.

Edit Channel			
No.	Channel Name	Block	Fav.
4-1			

3. On the “Edit Channel” menu, press \triangle or ∇ to highlight Edit, and then press **Enter**.
4. To block channels, press \triangleleft or \triangleright and \triangle or ∇ buttons to highlight the channel **BLOCK** column and press **Enter**.
5. To add channels to the favorite channel list, press \triangleleft or \triangleright and \triangle or ∇ buttons to highlight the **FAV.** column and press **Enter**.

DTV Rating Setting

This menu lists both MPAA and USTV (FCC) Parental ratings. You can independently lock the MPAA and TV ratings. The locked ratings are indicated by the lock symbol.

Under the **CHANNEL CONTROL** options:

1. Press the \triangle or ∇ button to select

RATING item.

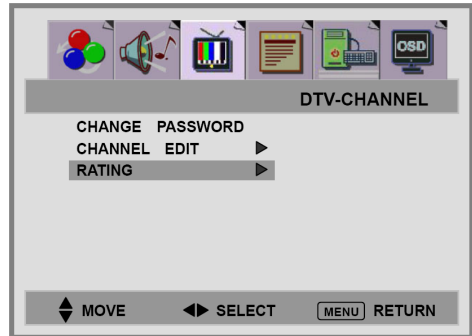
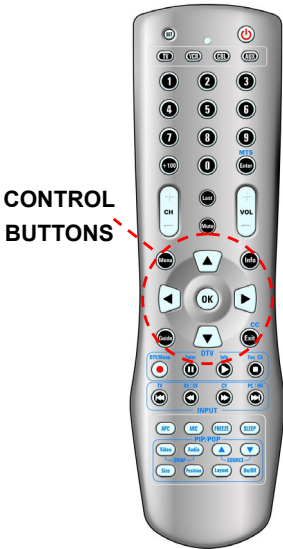

2. Press the \triangleright button to enter the **RATING CONTROL** menu.

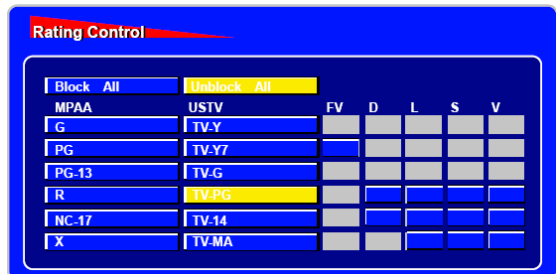

3. Press \triangleleft or \triangleright and \triangle or ∇ buttons and the ENTER button to activate the appropriate restrictions for either the MPAA rating system or the USTV(FCC) rating system.

Note: When a locked program is accessed, you will see the message "Program is rating blocked" on the screen.

Rating (Lock Programs by Rating)

Explanation of the MPAA and TV (FCC) Rating Systems:

USTV (FCC) Age-Based Ratings

- TV-Y** All children. The themes and elements in this program are specifically designed for a very young audience, including children from ages two to six.
- TV-Y7** Directed to older children. Themes and elements in this program may include mild physical or comedic violence, or may frighten children under the age of seven.
- TV-G** General audience. The program contains little or no violence, no strong language, and little or no sexual dialogue or situations.
- TV-PG** Parental guidance suggested. The program may contain infrequent coarse language, limited violence, some suggestive sexual dialogue and situations.
- TV-14** Parents strongly cautioned. This program may contain sophisticated themes, sexual content, strong language and more intense violence.
- TV-MA** Mature audiences only. This program may contain mature themes, profane language, graphic violence and explicit sexual content.

USTV (FCC) Content Category

V Violence.	S Sexual content.
L Offensive language.	D Dialogue and sexual innuendo.
FV Fantasy or cartoon violence.	

MPAA Rating System (Movies)

- G** General audience. No restriction.
- PG** Children under 13 should be accompanied by an adult.
- PG-13** Parental guidance suggested. Children under 13 should be accompanied by an adult.
- R** Restricted. Viewers should be 17 or older.
- NC-17** Not classified. Viewers should be 17 or older.
- X** Adults only.

* USTV (FCC) ratings: When the rating that you select is locked (as indicated by the green lock symbol), all of the content-based ratings are locked within the rating group. For example, locking the TV-G rating locks all of its contents (V, S, L, and D). More restrictive ratings (TV-PG, TV-14, and TV-MA) and all of their contents are also automatically locked.

* MPAA ratings: The particular rating that you have selected will be locked. In addition, more restrictive ratings will be locked as well.

* Neither USTV (FCC) ratings nor MPAA ratings apply to news programs.

Closed Caption Options

At Digital TV mode, follow these steps to turn on closed captioning:

You must use the remote control to enable / disable the function.

If the I-Plate indicates that there is Closed Caption data on the current channel, pressing the **CC** or **Exit / CC** button on the remote control will display the C.C. Options list on the TV screen.

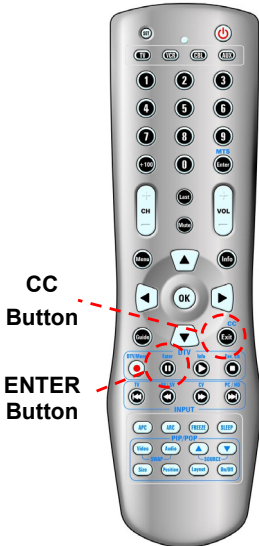

1. Press the **Exit / CC** button to display the C.C. Options.

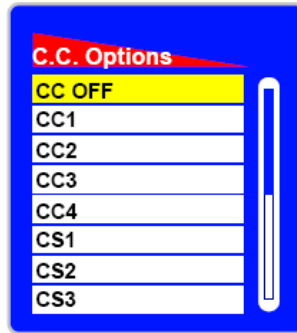

2. Press the \triangle or ∇ button to select C.C. rating.
3. Press the **Enter** button to confirm it.
4. Press the **Menu** or **Exit** to exit setting.

INFO (Information-Plate)

When you are watching digital channels, you can view the current program name and relevant information by pressing the “INFO” button to show I-Plate on screen.



Current Program

After pressing the *Info* button, the I-Plate appears including this information:

- TV Station Name
- Current Channel Number
- Current Local Time
- Program Name
- Program start and end time
- Picture resolution
- Closed Caption
- Audio System (PCM)
- Program Rating Information

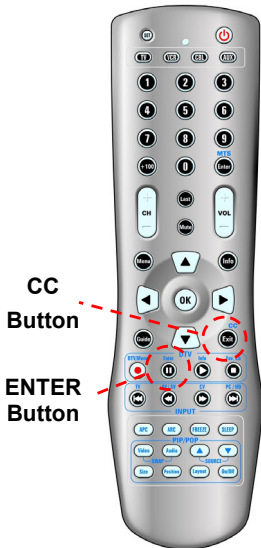

Next Program

Press the ▷ button to display information for the NEXT program. Press the ◁ button to display information for the PREVIOUS program.

Extended Program Information

1. Press the *Info* button again to display extended program information for the current TV channel.
2. Press the *Info* button again to close the I-Plate or Extension window, or press the *Exit* button to exit the I-Plate window.

MTS (Multitrack Language Selection-Design)

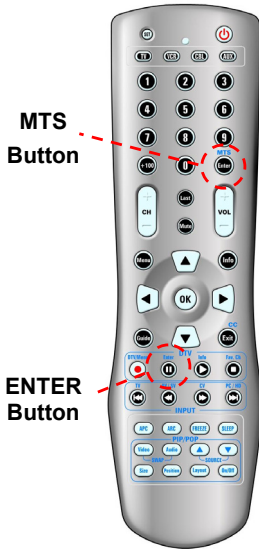

1. Press the **Enter / MTS** button to display the Multi-language window.
2. Use \triangle or ∇ keys to highlight the language you want and press **Enter**.
3. Press the **Exit** button to close the language window.



Favorite Channel List

Fav. CH
Button



1. When you are watching broadcast or cable TV channels, you can press the “FAV” button on the remote control to display the Favorite Channel List.
2. Use ◀ or ▶ keys to select the input source program lists.
3. Use ▲ or ▼ keys to highlight the program you want and press the *Enter* button.

ALL		OFFAIR		CABLE	
04-1		04-1			

Note: The channel table of the Receiver will follow settings in this menu. To view ATSC channels only, select the ATSC channel list. To browse all of the ATSC channels, select the “All” channel list. If you are browsing ATSC channels and would like to switch to.

Selecting Digital Channels



Selecting digital channel numbers is different from selecting traditional channel numbers. For example, To select digital channel number: 10 - 2

- (1) press numeric key “1” and “0”
- (2) press the “▷” button
- (3) press the numeric key “2”

Freezing the Picture



1. Press the “**FREEZE**” button on the remote control to freeze the picture. The "Freeze" message will appear in the upper right corner of the screen.
2. Pressing the “**FREEZE**” button again will release the picture.

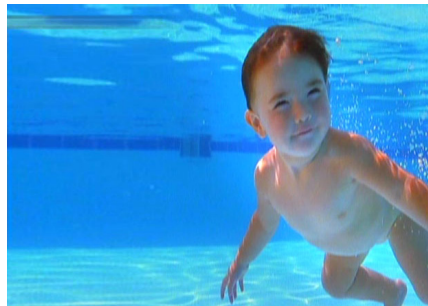

E. Other Functions

1. **Channel +/-** :

Under TV mode, *Channel +/-* keys are for changing channels.

2. **Volume +/-** :

Under any display mode, "*Volume +/-*" are for adjusting sound volume.

3. **ARC** (Aspect Ratio Control):

- **Full** : Expands 4:3 video sources both vertically and horizontally to fill the entire screen while keeping the original aspect ratio..
- **Normal** : Sets the aspect ratio to 4:3. There will be black bars to the left and right sides of the image.
- **Panorama** : This mode expands the width of 4:3 video sources evenly to fill the 16:9 screen. There will be distortion as all four edges of the image are stretched, creating less distortion at the center of the screen.
- **Zoom 1**: Extends the image height to fill the screen by stretching the image vertically.
- **Zoom 2**: Same as "16:9 Zoom", but the bottom edge of the screen pulls up a little for the subtitle purpose.

(In PC mode, only has Full and Normal)

4. **APC** (Automatic Picture Control):

Automatic Picture Control allows you to easily set the screen luminosity based upon your environment. If in a well lit viewing area it may be necessary to turn up the screen intensity via the APC "BRIGHT" setting to make the image viewable. Likewise if in a dark viewing area it may be necessary to turn down the screen intensity via the APC "MOVIE" setting. Toggle the **APC** button to scroll through the four APC modes to select the mode that best suits your situation.

5. **MTS** (Multi-Television-Sound):

- There are three supported MTS modes: "Mono", "Stereo" or "SAP" (Secondary Audio Program).
- This LCD TV has the ability to decode stereo or SAP broadcasts.

Programming Remote Control

A. Direct Device Code Setup

Although your Remote Control is set up to provide control of this TV, you can specify other devices to be controlled, according to the following steps.

[MODE] → <<SET>> (2 blinks) → 5- digit device codes (2 blinks)

STEP 1 Locate the desired device in the Device code list.

STEP 2 Select the [MODE] by pressing **VCR**, **CBL**, or **AUX**.

[MODE]	Device Assignment	Device Group no.
TV	Locked to this TV (Default)	-----
VCR	Universal VCR, DVD, PVR	2
CBL	Universal Cable, Satellite, Video Accessory	0
AUX	Universal Tuner, Amplifier, CD, Mini Disc. And Misc. Audio, Home Automation	3

STEP 3 Depress and hold <<SET>> button for a minimum of 3 seconds until LED blinks twice.

STEP 4 Enter the 5-digit code for the desired device. The LED blinks once for every digit entered except for the last digit, where it shall blink twice to confirm that a valid code has been programmed.

NOTE

- * Each digit must be entered within 10 seconds, or the Remote Control shall exit programming state.
- * Two short LED blinks indicate recognition of the code, after which device control via the remote is enabled.
- * A long LED display indicates non-recognition of the code, at which time the code should be re-entered.

Example: [VCR] → <<SET>> (2 blinks) → [2] → [0] → [0] → [3] → [5] (2 blinks).

B. Searching for a Device Code

If none of the codes listed under Device Codes list match your device, you can search for a set of commands that will work. Your Remote will sample all the codes in its system to find one that will allow you to control your device. As the Remote searches its library, it starts with the most popular device in the category and works through to the end. To cycle through each available device code and sample its functions:

[MODE] → <<SET>> (2 blinks) → [9] [9] [1] (2 blinks) → [Device Group No.] (2 blinks) → [POWER] → [CH +] → [CH +] → [CH +] → ... [SET] (2 blinks)

[MODE]	Device Assignment	Device Group No.
TV	Locked to this TV (Default)	-----
VCR	Universal VCR, DVD, PVR	2
CBL	Universal Cable, Satellite, Video Accessory	0
AUX	Universal Tuner, Amplifier, CD, Mini Disc. And Misc. Audio, Home Automation	3

- STEP 1** Select the [MODE] by pressing **VCR**, **CBL**, or **AUX**.
- STEP 2** Depress and hold <<SET>> button for a minimum of 3 seconds until LED blinks twice.
- STEP 3** Enter the code sequence [9][9][1]. The LED blinks once for every digit entered except for the last digit, where it shall blink twice to confirm that [9][9][1] are entered correctly.
- STEP 4** Press **POWER** button. Then, pressing **CH+** repeatedly to cycle through each corresponding function until your device turns off (or on).
- STEP 5** Pressing **SET** button will store the new device code and returns to normal operation. The LED blinks twice in confirmation.

Example:

[VCR] → <<SET>> (2 blinks) → [9] → [9] → [1] (2 blinks) → [2] (2 blinks) → [POWER] → [CH +] → [CH +] → ... [SET] (2 blinks).

C. Device Codes

The following sections list the available device codes for each device mode button. If there is more than one code listed for device, enter the first one, and then try the POWER button. If the device turns on (or off), the code is correct. If it does not, try the next code. Repeat until you find a code that works.

Cable Converters			
ABC	00003, 00008, 00014	Paragon	00000
Americast	00899	Philips	00317, 01305
Bell & Howell	00014	Pioneer	01877, 00877, 00144, 00533
Bell South	00899	Pulsar	00000
Clearmaster	00883	Quasar	00000
ClearMax	00883	RadioShack	00883
Coolmax	00883	Regal	00279, 00273
Daeryung	01877, 00877, 00477, 00008	Runco	00000
Digi	00637	Samsung	00000, 00144
Director	00476	Scientific Atlanta	01877, 00877, 00477, 00008
Dumont	00637	Sony	01006
Gehua	00476	Starcom	00003, 00014
General Instrument	00476, 00810, 00276, 00003, 00014	Supercable	00276
GoldStar	00144	Supermax	00883
Hamlin	00009, 00273	Tocom	00012
Hitachi	00014	Torx	00003
Jerrold	00476, 00810, 00276, 00003, 00012, 00014	Toshiba	00000
KNC	00008	Trans PX	00276
LG	00144	Tristar	00883
Memorex	00000	TS	00003
Motorola	00476, 00810, 00276, 01254, 01376	V2	00883
MultiVision	00012	Viewmaster	00883
Pace	01877, 00237	Vision	00883
Panasonic	00000, 00008, 00107	Vortex View	00883
Panther	00637	Zenith	00000, 00525, 00899

Satellite Receivers			
AlphaStar	00772	NEC	01270
Chaparral	00216	Next Level	00869
Crossdigital	01109	Panasonic	00247, 00701
DirecTV	00392, 00566, 00639, 01142, 00247, 00749, 01749, 00724, 00819, 01856, 01076, 01109, 00099, 01392, 01640, 01442, 01414, 01108	Paysat	00724
Dish Network System	01005, 00775, 01505	Philips	01142, 00749, 01749, 00724, 01076, 00722, 00099, 01442
Dishpro	01005, 00775, 01505	Proscan	00392, 00566
Echostar	01005, 00775, 01505	Proton	01535
Expressvu	00775	RadioShack	00869
GE	00566	RCA	00392, 00566, 00855, 00143, 01392
General Instrument	00869	Samsung	01276, 01109, 01108
GOI	00775	Sanyo	01219
Goodmans	01246	SKY	00856
Hisense	01535	Sony	00639, 01640
Hitachi	00819, 00222, 01250	Star Choice	00869
HTS	00775	Tivo	01142, 01442
Hughes Network Systems	01142, 00749, 01749, 01442	Toshiba	00749, 01749, 00790, 01285
I-Lo	01535	UltimateTV	01640, 01392
JVC	00775	Uniden	00724, 00722
LG	01414, 01226	US Digital	01535
Magnavox	00724, 00722	USDTV	01535
Memorex	00724	Voom	00869
Mitsubishi	00749	Zenith	00856, 01856
Motorola	00869	-----	-----

Audio Amplifiers			
Bose	30674	Sansui	30321
GE	30078	Shure	30264
JVC	30331	Sony	30689
Marantz	30321	Soundesign	30078
Nakamichi	30321	Victor	30331
NEC	30264	Wards	30078
Optimus	30395	Yamaha	30354, 30133
Realistic	30395	-----	-----

Audio Amp/Tuners			
ADC	30531	Onkyo	30842, 30135
Aiwa	31405, 31243, 30121	Optimus	31023, 30670, 30531, 31074
Anam	31609, 31074	Panasonic	31518, 30039
Audiotronic	31189	Philips	31189, 31269
Bose	31229	Pioneer	31023, 30150, 30014, 30630, 30531
Capetronic	30531	Proscan	31254
Carver	31189	Qisheng	31609
Coby	31263	Quasar	30039
Denon	31360, 31142, 30904	RadioShack	31263
Fonmix	31360	RCA	31023, 31609, 31254, 30531, 31074
Glory Horse	31263	Sharper Image	31263
Harman/Kardon	30110	Silsonic	30176
Hitachi	31273	Sony	31058, 31441, 31258, 31759
Inkel	30027	Soundesign	30670
Integra	30135	Stereophonics	31023
JBL	30110	Sunfire	31313
JVC	30074, 31263	Teac	31074, 31267
Kenwood	31313, 31570, 30027	Technics	31308, 31518, 30039
KLH	31428	Thorens	31189
Magnavox	31189, 31269, 30531	Victor	30074
Marantz	31189, 31269, 30039	Wards	30014
MCS	30039	Yamaha	30176, 31276, 31176

VCR			
ABS	21972	Gateway	21972
Admiral	20048, 20209	GE	20060, 20035, 20240
Aiko	20278	General	20045
Aiwa	20037, 20479	Go Video	20432
Alienware	21972	GoldStar	20037, 20209, 20038,
America Action	20278	Haojie	20240
American High	20035	Harman/Kardon	20081, 20038
Amoisonic	20479	Harwood	20072
Anam	20162, 20037, 20240,	Hewlett Packard	21972
Anam National	20162	HI-Q	20047
Asha	20240	Hitachi	20037, 20042, 20055
Audiovox	20037, 20278	Howard	21972
Beaumarck	20240	HP	21972
Bell & Howell	20104	Hughes Network Systems	20042, 20739
Broksonic	20184, 20121, 20209, 20002, 20479	iBUYPOWER	21972
Calix	20037	JVC	20045, 20067
Canon	20035	KEC	20037, 20278
Carver	20081	Kenwood	20067, 20038
CCE	20072, 20278	KLH	20072
Changhong	20048, 20081	Kodak	20035, 20037
Citizen	20037, 20278	Kolin	20043
Colt	20072	LG	20037, 20045, 20042, 20209, 20038
Craig	20037, 20047, 20240,	Logik	20072
Curtis Mathes	20060, 20035, 20162	LXI	20037
Cybermex	20240	Magnavox	20035, 20039, 20081
CyberPower	21972	Magnin	20240
Daewoo	20045, 20104, 20278	Marantz	20035, 20081
Dell	21972	Marta	20037
Denon	20042	Matsushita	20035, 20162
DirecTV	20739	Media Center PC	21972
Durabrand	20039, 20038	MEI	20035, 20162, 20037, 20048, 20039, 20047, 20240, 20104, 20209, 20479
Electrohome	20037	Memorex	20035
Electroponic	20037	MGA	20240, 20043
Emerex	20032	MGN Technology	20240
Emerson	20035, 20037, 20184, 20240, 20045, 20121, 20043, 20209, 20002, 20278, 20479	Microsoft	21972
Fisher	20047, 20104	Mind	21972
Fuji	20035, 20033	Minolta	20042
Fujitsu	20045	Mitsubishi	20067, 20043

VCR			
Motorola	20035, 20048	Scott	20184, 20045, 20121,
MTC	20240	Sears	20035, 20037, 20047, 20042, 20104
Multitech	20072	Sharp	20048, 20209
NEC	20035, 20037, 20048, 20104, 20067, 20038	Shintom	20072
Newave	20037	Shogun	20240
Nikko	20037	Singer	20072
Noblex	20240	Sonic Blue	20616
Northgate	21972	Sony	20035, 20032, 20033, 20636, 21972
Olympus	20035	STS	20042
Optimus	21062, 20162, 20037, 20048, 20104, 20432	Sylvania	20035, 20081, 20043
Orion	20184, 20209, 20002,	Systemax	21972
Panasonic	21062, 20035, 20162, 20616, 20225	Tagar Systems	21972
Penney	20035, 20037, 20240, 20042, 20038	Tashiko	20037
Pentax	20042	Tatung	20045, 20067
Philco	20035, 20479	Technics	20035, 20162
Philips	20035, 20081, 20739,	Teco	20035, 20037, 20048,
Pilot	20037	Teknika	20035, 20037
Pioneer	20042, 20067	Tivo	20636, 20618, 21503,
Polk Audio	20081	TMK	20240
Proffrionic	20240	Toshiba	20045, 20042, 20067, 20043, 21503 21008, 21972
Proscan	20060	Totevision	20037, 20240
Protec	20072	Touch	21972
Pulsar	20039	Unitech	20240
Qisheng	20060	Vector	20045
Quasar	20035, 20162	Vector Research	20038
Radix	20037	Victor	20067
Randex	20037	Video Concepts	20045
RCA	20060, 20035, 20240, 20042, 20880	Videomagic	20037
Realistic	20035, 20037, 20048, 20047, 20104	Videosonic	20240
ReplayTV	20616	Viewsonic	21972
Runco	20039	Wards	20060, 20035, 20048, 20047, 20081, 20240, 20042, 20072
Sampo	20037, 20048	White	20209, 20072
Samsung	20240, 20045, 20432	XR-1000	20035, 20072
Sanky	20048, 20039	Yamaha	20038
Sansui	20067, 20209, 20479	Zenith	20039, 20033, 20209,
Sanyo	20047, 20240, 20104	ZT Group	21972

DVD Player			
Aiwa	20641, 21912	Microsoft	20522
Akai	20770	Mintek	20717
Allegro	20869	Mitsubishi	21521, 20521
Apex Digital	20672, 20717, 20797, 21061, 20796, 21056, 21937, 20794, 21020, 21915	Nesa	20717
Blaupunkt	20717	Norcent	21003
Blue Parade	20571	Onkyo	20503, 20627, 21924,
Broksonic	20695	Oritron	20651, 21980
Changhong	20627, 21061	Panasonic	20490, 21762, 21990
CineVision	20869	Philips	20503, 20539, 20646,
Coby	21086	Pioneer	20525, 20571
Curtis Mathes	21087	Polaroid	21086, 21061
CyberHome	21024, 21023, 21129, 20816, 21117	Polk Audio	20539
Daewoo	20833, 21172, 20869	Portland	20770
Denon	20490	Proscan	20522
DVD2000	20521	Qwestar	20651
Emerson	20591, 20675	RCA	20522, 20571, 20717,
Enterprise	20591	Rio	20869
Fisher	21919	Rotel	20623
Funai	20675	Sampo	20752, 20698
Gateway	21158, 21073	Samsung	20490, 20573, 21932, 21075, 20820
GE	20522, 20717	Sansui	20695
Go Video	20744, 20833, 21099, 20783, 21075, 20869, 21730	Sanyo	20695
Greenhill	20717	Sharp	20630, 20752
Harman/Kardon	20582, 20702	Sharper Image	21117
Hitachi	20573, 20664, 21919	Sherwood	20770
Hiteker	20672	Shinco	20717
Initial	20717	Shinonic	20533
Integra	20627, 21924	Sonic Blue	20869, 21099
JBL	20702	Sony	20533, 20864, 21033, 21904, 21903
JVC	20558, 20623, 20867	SVA	20717
Kenwood	20490, 20534	Sylvania	20675
KLH	20717, 21020, 21149	Symphonic	20675
Koss	20651, 21980	Teac	20717, 21984, 20809
Lasonic	20798	Technics	20490
LG	20591, 20869, 20801	Theta Digital	20571
Liquid Video	21980	Toshiba	20503, 20695
Lite-On	21158, 21058	Urban Concepts	20503
Loewe	20511	Xbox	20522
Magnavox	20503, 20539, 21976, 21914, 20675	Yamaha	20490, 20539, 20545
Marantz	20539	Zenith	20503, 20591, 20869
Memorex	20695	-----	-----

Troubleshooting

There is no picture or sound.



- Make sure the AC adapter is connected.
- Verify that there is a valid source signal.
- Make sure the correct input mode is selected.
- Make sure the master power switch has been turned on.

There is no picture from AV.



- Make sure the BRIGHTNESS is properly adjusted.
- The florescent lamp may have reached the end of its life. Contact an authorized service center.
- Make sure the video source is plugged into the composite video-in port.

There is no sound.



- Make sure the volume is not set to minimum.
- Make sure the sound is not muted
- Make sure that headphones are not connected.

There is no picture or sound, just noise.

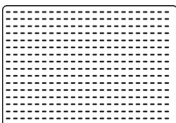

- The source signal may be weak.
- Your provider may be experiencing difficulties.
- Check your input connections.

Picture is not clear.



- The source signal may be weak.
- The provider may be experiencing difficulties.
- Check input connections.

Picture is light or improperly tinted.



- Check the Hue, Saturation and Color adjustments.
- Reset the TV to the factory default settings.

The picture is too dark.



- Select a different APC mode.
- Check the PICTURE and BRIGHTNESS adjustments.
- The fluorescent lamp may have reached the end of its life. Contact an authorized service center.

Remote control does not work.



- Install new batteries.
- Make sure the remote sensor window isn't blocked.

The picture is not sharp.



- The signal source may be weak.
- The provider may be experiencing difficulties.
- Check input connections.

The picture moves.



- The source signal may be weak.
- The provider may be experiencing difficulties.
- Check input connections.

The picture is doubled or tripled.



- The source signal may be weak.
- Check input connections.

The picture is spotted.



- There may be interference from other appliances nearby or around the LCD TV.

There are stripes on the screen or colors fade.



- There may be interference from other appliances.
- There may be interference between the video source cable and the power cable. Make sure the power and video cables are not touching.
- Check the Hue, Saturation and Color adjustments.

PC / DVI Timing Table

Mode No.	Mode Name Resolution	H. Freq (KHZ) V. Freq (HZ)	H. Polarity V. Polarity	Pixel CLK (MHZ)	Hor. Total	Hor. Display	H. Back Porch	Hor. Sync Width	Ver. Total	Ver. Display	V. Back Porch	Ver. Sync Width
1	VGA 60HZ 640*480	31.469 59.941	- -	25.175	800	640	48	96	525	480	33	2
2	MAC VGA 640*480	35.000 66.667	- -	30.24	864	640	96	64	525	480	39	3
3	VGA 75HZ 640*480	37.5 75.0	- +	31.5	840	640	120	64	500	480	16	3
4	US TEXT 720*400	31.469 70.087	- -	28.322	900	720	54	108	449	400	35	2
5	STB 768*576	31.250 50	- -	29.75	952	768	124	32	625	576	29	13
6	SVGA 60HZ 800*600	37.879 60.317	+ +	40.0	1056	800	88	128	628	600	23	4
7	SVGA 75HZ 800*600	46.875 75.0	+ +	49.5	1056	800	160	80	625	600	21	3
8	XGA 60HZ 1024*768	48.363 60.004	- -	65.0	1344	1024	160	136	806	768	29	6
9	XGA 70HZ 1024*768	56.476 70.069	- -	75.0	1328	1024	144	136	806	768	29	6
10	WSGA 1280*768	47.708 60	- -	80	1676	280	198	136	795	768	23	3
11	WSGA 1360*768	47.712 60.000	+ +	85	1792	1360	256	112	795	768	18	6

HDMI / HDCP Timing

Mode No.	Mode Name Resolution
1	480i
2	480p
3	720p
4	1080i

Specifications

ITEMS		SPECIFICATION	
Panel	Screen Size	37.07" TFT-LCD Panel (CMO)	
	Aspect Ratio	16 : 9	
	Resolution	1920 x 1080	
	Display Area (opening) H x V	820.8 mm x 461.7 mm	
	Pixel Pitch	0.1425 mm x 0.4275 mm x RGB	
	Display colors	16,777,216 colors	
	Contrast Ratio (for AI)	1000 : 1 (typ.)	
	Brightness (center)	600 cd / m ² (typ.)	
	Viewing Angle (CR>10)	176° Hor. / 176° Ver. (typ.)	
Response Time (GTG)	8 ms (typ.)		
TV Function	Broadcasting System	Analog : NTSC M / N ,	Digital* : ATSC
	Receiving Channel	Analog : PLL181Ch., CATV 125Ch	Digital* : 54M Hz~864M Hz
	Sound System	Analog : MTS+SAP ,	
	Resolution	Analog : 480i	Digital* : 1080i, 720p,480p, 480i
	Data Broadcasting	Close Caption , V - Chip	
Video Input	Composite Signal	CVBS	x 2
	Y, C Signal	S-Video	x 2
	Component Signal	Y Pb Pr	x 2 (720P / 1080i , HDTV ready)
PC Input	VGA Connection	D-Sub 15 pin	x 1
	Scanning Frequency	f _H = 31.5K ~ 75KHz / f _V = 56 ~ 75Hz	
Audio Input	Audio 1	Composite	x 2
		S - Video	x 2
	Audio 2	Component	x 2
	Audio 3	PC	x 1
HDMI Connection	HDMI 19 pin	x 1 (HDMI 1.0 / HDCP 1.1)	
Video Output	Composite (RCA jack)	TV (analog)	x 1
Audio Output	Speaker (build-in)	10W + 10W (rms) @THD < 10% (7W + 7W @ THD < 1%)	
	Line Out	Left / Right / Subwoofer	
	S / PDIF	Analog : None Digital : Dolby AC3 / PCM / MPEG	
Feature	Function Keys	Power , Source , Menu , Up/Down(Channel) , +/- (Volume) , Aspect .	
	Video Performance	Picture in Picture (PIP) , Picture on Picture (POP) , 3D Comb-filter , 3D De-interlace , Aspect Ratio Control (ARC) , Auto Picture Control Video Enhance , Noise Reduction .	
	Audio Performance	Equalizer , Subwoofer , Auto Volume Control (AVC) .	
	Other Control	Sleep Timer , Auto Power Off .	
Power	Power Supply	AC 100V ~ 240V , 50 / 60Hz	
	Power Consumption	250 W	
Dimension	W x H x D	1111.3mm * 632.3mm * 279.7mm	
Weight (net)	Without Accessories	26.5 Kg	

Planar Systems, Inc.

Customer Service

Online Support : <http://www.planar.com/support>

Email : PlanarSupport@planar.com

Tel : 1-866-PLANAR-1 (1-866-752-6271)

Hours : M-F, 8am-8pm Eastern Time (5am-5pm Pacific Time)

©2006 Planar Systems, Inc. Planar is a registered trademark of Planar Systems, Inc.

Other brands and names are the property of their respective owners.

Technical information in this document is subject to change without notice.

E030057208

Free Manuals Download Website

<http://myh66.com>

<http://usermanuals.us>

<http://www.somanuals.com>

<http://www.4manuals.cc>

<http://www.manual-lib.com>

<http://www.404manual.com>

<http://www.luxmanual.com>

<http://aubethermostatmanual.com>

Golf course search by state

<http://golfingnear.com>

Email search by domain

<http://emailbydomain.com>

Auto manuals search

<http://auto.somanuals.com>

TV manuals search

<http://tv.somanuals.com>