



G.SHDSL Bridge/Router

GRT-101/GRT-401/GRT-402

User's Manual



Copyright

Copyright (C) 2007 PLANET Technology Corp. All rights reserved.

The products and programs described in this User's Manual are licensed products of PLANET Technology. This User's Manual contains proprietary information protected by copyright, and this User's Manual and all accompanying hardware, software, and documentation are copyrighted.

No part of this User's Manual may be copied, photocopied, reproduced, translated, or reduced to any electronic medium or machine-readable form by any means by electronic or mechanical. Including photocopying, recording, or information storage and retrieval systems, for any purpose other than the purchaser's personal use, and without the prior express written permission of PLANET Technology.

Disclaimer

PLANET Technology does not warrant that the hardware will work properly in all environments and applications, and makes no warranty and representation, either implied or expressed, with respect to the quality, performance, merchantability, or fitness for a particular purpose.

PLANET has made every effort to ensure that this User's Manual is accurate; PLANET disclaims liability for any inaccuracies or omissions that may have occurred.

Information in this User's Manual is subject to change without notice and does not represent a commitment on the part of PLANET. PLANET assumes no responsibility for any inaccuracies that may be contained in this User's Manual. PLANET makes no commitment to update or keep current the information in this User's Manual, and reserves the right to make improvements to this User's Manual and/or to the products described in this User's Manual, at any time without notice.

If you find information in this manual that is incorrect, misleading, or incomplete, we would appreciate your comments and suggestions.

CE mark Warning

The is a class B device, In a domestic environment, this product may cause radio interference, in which case the user may be required to take adequate measures.

Trademarks

The PLANET logo is a trademark of PLANET Technology. This documentation may refer to numerous hardware and software products by their trade names. In most, if not all cases, these designations are claimed as trademarks or registered trademarks by their respective companies.

Revision

User's Manual for PLANET G.SHDSL Bridge/Router:

Model: GRT-101/ GRT-401/ GRT-402 (GRT series)

Rev: 4.0 (Nov. 2007)

Part No. EM-GRTV4

Table of Contents

Table of Contents	3
Chapter 1 Overview	1
SOFTWARE FEATURES	1
SOFTWARE SPECIFICATIONS	1
ATM Protocol.....	1
PPP Support	2
Routing Capability	2
Bridging	2
Configuration.....	2
Network Management	2
Hardware Specification	3
Chapter 2 Installation	4
2.1 Front Panel LEDs	4
2.2 Rear Panel Ports	5
2.3 Rear Panel Connections	5
2.4 Setting up the hardware environment.....	7
Chapter 3 Configuration	8
3.1 Purpose	8
3.2 Logon Procedure.....	8
3.2.1 <i>Serial console</i>	8
3.2.2 <i>Telnet</i>	9
3.2.3 <i>Web browser</i>	9
3.3 Web operation and Quick Installation Guide	10
3.3.1 <i>Bridge Mode</i>	10
Web UI Configuration	11
Console Configuration.....	12
3.3.2 <i>Routing Mode for PPPoA and PPPoE with IP Sharing</i>	12
Web UI Configuration	12
Console Configuration.....	15
3.3.3 <i>Routing Mode for IPoA or EoA</i>	16
Web UI Configuration	16
Console Configuration.....	18
3.3.4 <i>LAN-to-LAN Connection with Bridge Mode</i>	19
Web UI Configuration	19

STU-C (CPE) side	21
Console Configuration	21
3.3.5 <i>Advanced Setup</i>	22
SHDSL	22
WAN	22
Bridge	24
Route	24
NAT/DMZ	27
Virtual Server	28
3.3.6 <i>Administration</i>	29
Security	29
SNMP	30
Time Sync	31
Config Tool	32
Upgrade	33
Restart	33
3.3.7 <i>Status</i>	33
3.4 <i>Command Line Interface</i>	34
3.4.1 <i>Multi-level password protection</i>	35
3.4.2 <i>Menu Driven Command Line Interface</i>	36
3.4.3 <i>Command Line Interface Menu Tree</i>	36
3.4.4 <i>Status</i>	41
3.4.5 <i>Show</i>	41
3.4.6 <i>Write</i>	41
3.4.7 <i>Reboot</i>	42
3.4.8 <i>Ping</i>	42
3.5 <i>Administration</i>	42
3.5.1 <i>User Profile</i>	42
3.5.2 <i>Security</i>	43
3.5.3 <i>SNMP</i>	43
3.5.4 <i>Supervisor Password and ID</i>	43
3.5.5 <i>SNTP</i>	44
3.6 <i>Utility</i>	44
3.7 <i>Exit</i>	44
3.8 <i>Setup</i>	45
3.8.1 <i>Mode</i>	45
3.8.2 <i>SHDSL</i>	45
3.8.3 <i>WAN</i>	46

3.8.4 Bridge	47
3.8.5 Route	47
3.8.6 LAN.....	47
3.8.7 IP share	47
3.8.8 DHCP.....	48
3.8.9 DNS proxy	48
3.8.10 Host name	48
3.8.11 Default.....	48
3.9 Connection Mode	49
3.10 Bridging Mode	49
3.10.1 Bridge management	49
3.10.2 Static bridge table	50
3.11 Routing Mode	51
3.11.1 LAN setting	51
3.11.2 Static routing table.....	52
3.11.3 NAT/PAT.....	53
3.11.4 DHCP server.....	56
3.11.5 DNS proxy.....	56
3.12 WAN and ATM Virtual Connection.....	57
3.12.1 SHDSL operation.....	57
3.12.2 ATM virtual connection.....	58
3.12.3 ATM traffic shaping	60
3.12.4 WAN IP address	61
3.12.5 ISP profile for PPP.....	61
3.13 System Status and Performance	63
3.14 User Profile.....	64
3.15 Management Security	65
3.15.1 Telnet port number.....	65
3.15.2 Legal client IP	66
3.16 SNMP Support	67
3.16.1 SNMP community	67
3.16.2 SNMP trap	68
3.17 Backup and Restore Configuration.....	68
3.17.1 Backup configuration	68
3.17.2 Restore configuration.....	69
3.18 Software Upgrade	70

Chapter 1 Overview

Based on digital subscriber line (DSL) technology, PLANET's G.SHDSL products, GRT series provide an affordable, flexible, efficient Internet access solution for SOHO customers while reducing deployment and operational costs from service providers. Via sending and receiving user's datagram (often Internet service) over existing telephone lines, GRT series concentrates all traffic onto a single high-speed trunk for Internet activities or sharing a corporate intranet. Through the simple-yet-powerful management UI of GRT series, networks administrators can complete a managed network deployment just in seconds.

SOFTWARE FEATURES

- Easy configuration and management with password control for various application environments
- Efficient IP routing and transparent learning bridge to support broadband Internet services
- VPN pass-through for safeguarded connections
- DMZ host / Multi-DMZ / Multi-NAT enables multiple workstations on the LAN to access the Internet for the cost of IP address
- Fully ATM protocol stack implementation over SHDSL
- PPPoA and PPPoE support user authentication with PAP / CHAP / MS-CHAP
- SNMP management with SNMPv1 / SNMPv2 agent and MIB II
- Getting enhancements and new features via firmware upgrade
- Built-in 4-port 10/100Mbps switch on GRT-401/GRT-402
- 4-wire supported in model GRT-402 double the bandwidth

SOFTWARE SPECIFICATIONS

ATM Protocol

ATM adaptation layer type 5 (AAL5)

VC multiplexing and LLC encapsulation

Multi-protocol over AAL5 (RFC 1483/2684 bridged and routed PDU)

Classical IP over ATM (RFC 1577 with MTU = 1500)

Up to 8 PVCs

Traffic shaping CBR/UBR

UNI 3.1/4.0 PVC

I.610 OAM F5 loopback

PPP Support

PPP (RFC 1661)

PPP over AAL5 (RFC 2364)

PPP over Ethernet (RFC 2516)

User authentication with PAP/CHAP/MS-CHAP

Routing Capability

Support IP/TCP/UDP/ARP/ICMP/IGMP protocols

IP routing with static routing and RIPv1/RIPv2 (RFC1058/2453)

IP multicast and IGMP proxy (RFC1112/2236)

Network address translation (NAT/PAT) (RFC1631)

NAT ALGs for ICQ/Netmeeting/MSN/Yahoo Messenger

DNS relay and caching (RFC1034/1035)

DHCP server (RFC2131/2132)

Bridging

IEEE 802.1D transparent learning bridge

Up to 128 MAC learning addresses

Configuration

Local console (RS232)

Telnet access

Web-based GUI (HTTP)

Multi-level password protection

Network Management

Web-based GUI for express setup, configuration and management

Menu-driven interface/Command-line interface (CLI) for local console and Telnet access

Password protected management and access control list for administration

SNMP management with SNMPv1/SNMPv2c (RFC1157/1901/1905) agent and MIB II (RFC1213/1493)

Software upgrade via web-browser/TFTP server

Hardware Specification

WAN/LAN Ports	RJ-11 SHDSL WAN port x1 10/100Mbps LAN port x1 on GRT-101 10/100Mbps LAN port x4 on GRT-401/GRT-402
Connector	RJ-11 connector for WAN, RJ-45 connector for LAN
Cabling Requirement	G.SHDSL : AWG26 or higher 10 /100 Base T: UTP/STP Category 3 or 5
LEDs	SHDSL, Power Status, WAN Link and Action Status, LAN Link/Active (and 100M Status), Alarm
Speed	SHDSL: 64Kbps to 2.304Mbps or 128Kbps to 4.608Mbps (for GRT-402, 4-wire mode) LAN Switch: 10/100 Mbps
Power	External power adapter 9V DC, 1000mA
Environmental	Operating temperature: 0° to 45°C Storage temperature: -10° to 70°C
Housing	Plastic Case
Dimension	145 mm x 187 mm x 33 mm (L x W x H)

Chapter 2 Installation

2.1 Front Panel LEDs

The LEDs on the front panel indicate the operational status of GRT series.

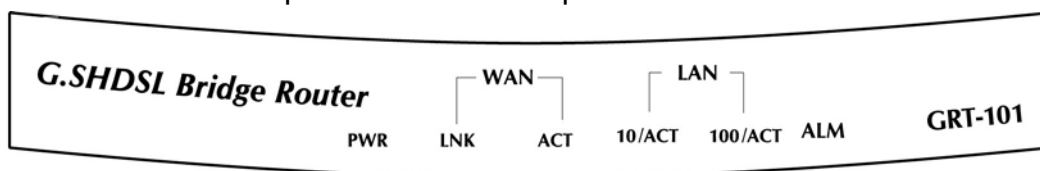

Figure 2-1 GRT-101 Front Panel

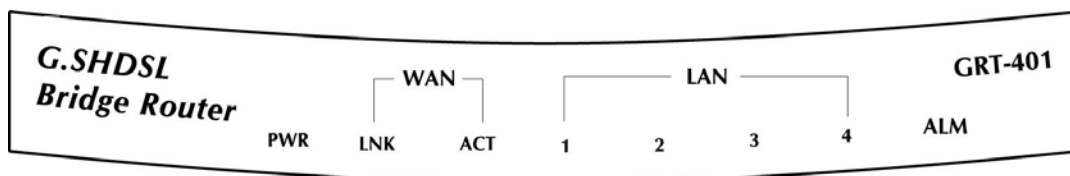

Figure 2-2 GRT-401 Front Panel

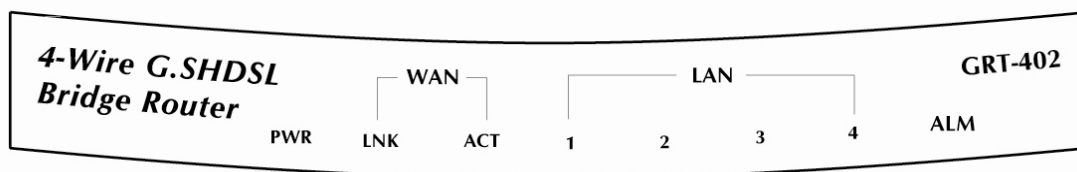

Figure 2-3 GRT-402 Front Panel

The following table describes the LEDs' functions:

Table 2-1 GRT-101 LED Functions

LEDs		Active	Color	Description
PWR		On	Green	Power adaptor is connected to GRT-101/GRT-401
WAN	LNK	On	Green	SHDSL line connection is established
	ACT	On	Green	Transmit or received data over SHDSL link
LAN	10/ACT	On	Green	LAN Speed operates in 10M
	100/ACT	On	Green	LAN Speed operates in 100M
ALM		On	Red	SHDSL connection disconnected

Table 2-2 GRT-401/GRT-402 LED Functions

	LEDs	Active	Color	Description
	PWR	On	Green	Power adaptor is connected to GRT-101/GRT-401
WAN	LNK	On	Green	SHDSL line connection is established
	ACT	On	Green	Transmit or received data over SHDSL link
LAN	1	On	Green	Transmit or received data over LAN 1
	2	On	Green	Transmit or received data over LAN 2
	3	On	Green	Transmit or received data over LAN 3
	4	On	Green	Transmit or received data over LAN 4
	ALM	On	Red	SHDSL connection disconnected

2.2 Rear Panel Ports

The connectors on the rear panel provide Power, LAN, CONSOLE and LINE interfaces.

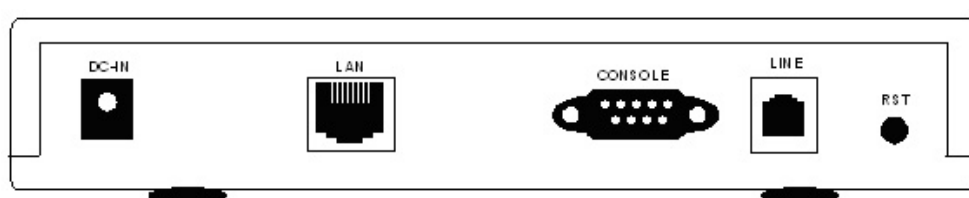

Figure 2-4 GRT-101 Rear Panel

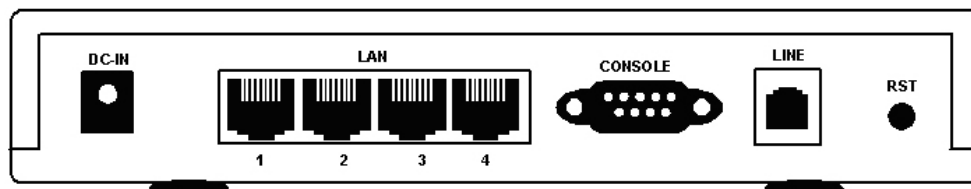

Figure 2-5 GRT-401/GRT-402 Rear Panel

The following table describes the connectors' functions:

Table 2-3 Connector Functions

Connectors	Description
DC-IN	Power adaptor inlet: Input voltage 9VDC
LAN	Ethernet interface for LAN port (RJ-45)
CONSOLE	RS- 232C (DB9) for system configuration and maintenance
LINE	SHDSL interface for WAN port (RJ-11)
RST	Reset button for factory default

2.3 Rear Panel Connections

The figure shows the rear panel connections of GRT series.

The STU-R is a standalone and can be placed on a desktop. All the external wiring shall be located at the rear panel. The LAN port is a 10 Base-T / 100Base-TX auto-sensing and half/full duplex Ethernet interface and complies with IEEE 802.3 / 802.3u respectively. The console (RS-232C) interface for configuration is menu-driven operation and can also be configured through Ethernet interface by Telnet or Web-based operation.

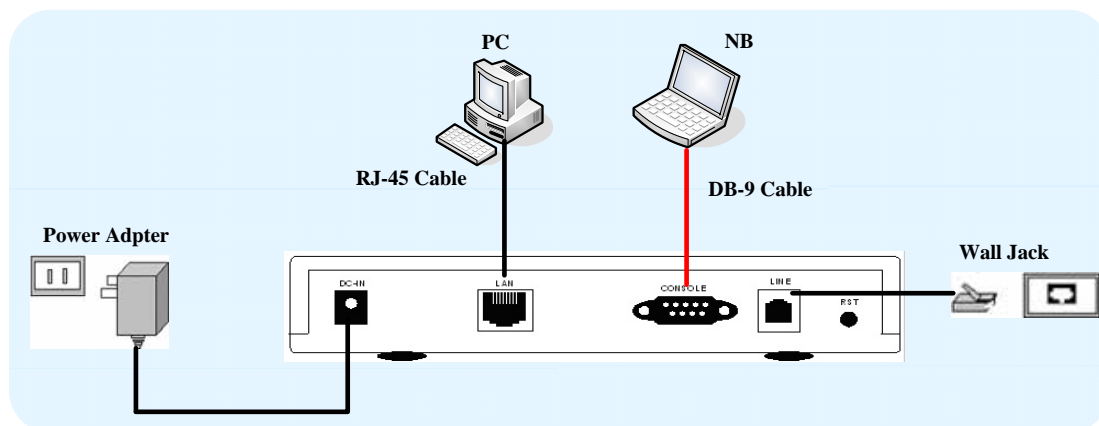

Figure 2-6 Direct Connection with PC or NB

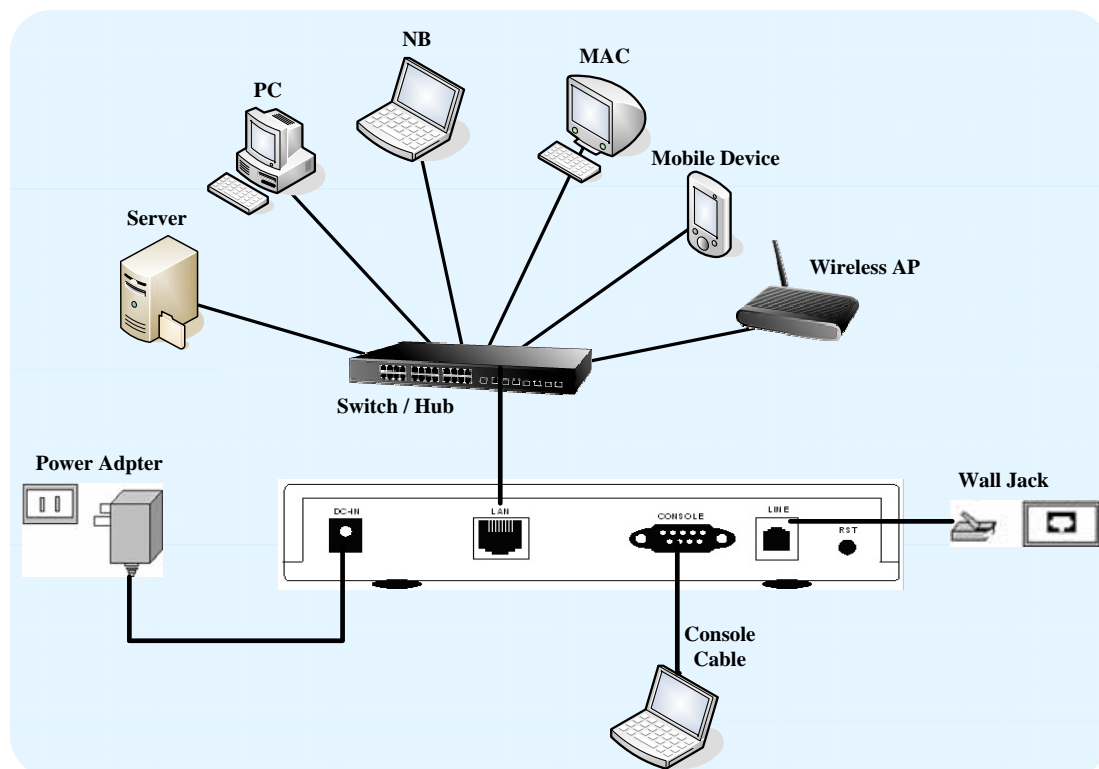

Figure 2-7 Connection with Switch or HUB

Note: GRT-401/GRT-402 support Auto-MDI (media dependence interface) that auto-detects MDI or MDI-cross with link partner, a standard straight wire UTP cable (EIA568) can be deployed to connect to a PC or Ethernet devices like hub/switches. GRT-101 supports MDI interface only.

2.4 Setting up the hardware environment

Step 1: Connect the power adapter to the port labeled DC-IN on the rear panel of the product.

Step 2: Connect the Ethernet cable.

If GRT-101 is directly connected to PC, the Ethernet cable has to be used cross over one (refer to figure 2-6). If the product is connected to hub or switch, be sure that the hub or switch supporting auto-MDI/MDI-X or not. If yes, both crossover and non-crossover Ethernet cable are suitable. If not, only non-crossover Ethernet cable could be used (refer to figure 2-7). Since GRT-401 and GRT-402's LAN port supports auto-MDI/MDI-X, both crossover and non-crossover Ethernet cable are suitable.

Step 3: Connect the phone cable to the product. Connect the other side of phone cable to wall jack.

Step 4: Connect male end of RS-232 cable to the product and female end to any free COM port in PC.

Step 5: Connect the power adapter by plugging power supply.

Chapter 3 Configuration

3.1 Purpose

This chapter provides information about configuring GRT series.

Note: After you have completed all necessary setting for GRT series, make sure to write the new configuration to NVRAM by **"write"** command and reboot the system, or all of your changes will not take effect.

3.2 Logon Procedure

There are three methods to logon to GRT series: serial console, Telnet, and web interface. For the first time configuration, perhaps only the serial console mode could be used because applications requiring Internet protocol (IP) communication, such as Telnet and web interface, are not available unless a management IP is configured properly for your local networking environment. After connecting all the necessary cables described in Chapter 2 Installation, power on GRT series and select one of the following procedures to access GRT series.

Note: It is recommended that only one configuration application is used to setup GRT series at any given time, that is, Telnet, serial console and the web management interfaces should not be used simultaneously.

3.2.1 Serial console

Check the connectivity of the RS-232 cable from your computer to the serial port of GRT series. Start your terminal access program with VT100 terminal emulation. Configure the serial link with baudrate of 9600, 8 data bits, no parity check, 1 stop bit, and no flow-control, and press the **SPACE** key until the login screen appears. When you see the login screen, you can logon to GRT series.

User: **admin**

Password: *****

Note: If you have not set any user profile for GRT series, enter the factory default user **"admin"**. When the system prompts you for a password, type **"admin"** to enter GRT series.

After you logon to GRT series and before proceeding any further, check the software version of GRT series by the command:

```
admin> show system
```

If firmware file is downloaded from our local distributor or FTP server, please refer to TFTP command in the section 3.18 Software Upgrade for more information on how to update GRT series firmware.

3.2.2 Telnet

Make sure the correct Ethernet cable is used for connecting the LAN port of your computer to GRT series. The LAN LNK indicator on the front panel shall light if a correct cable is used. Starting your Telnet client with VT100 terminal emulation and connecting to the management IP of GRT series, wait for the login screen appears. When you see the login screen, you can logon to GRT series.

User: **admin**

Password: *********

Note: The factory default management IP and subnet mask are of 192.168.0.1 and 255.255.255.0, respectively. To change these setting, see section 3.10.1 Bridge management and 3.11.1 LAN setting for routing mode operation. If you have not set any user profile for GRT series, enter the factory default user "**admin**". When the system prompts you for a password, type "**admin**" to enter GRT series. For more security issues for remote management interfaces such as Telnet and web interface, see section 3.15 Management Security.

3.2.3 Web browser

Make sure the correct Ethernet cable is used for connecting the LAN port of your computer to GRT series. The LAN LNK indicator on the front panel shall light if a correct cable is used. Starting your web browser and connecting to the management IP of GRT series, wait for the login screen appears. When you see the login screen, you can logon to GRT series.

Note: In this chapter, we use the GRT-101's Web UI for the examples.

Note: The factory default management IP and subnet mask are 192.168.0.1 and 255.255.255.0 respectively. To change these setting, see section 3.10.1 Bridge management and 3.11.1 LAN setting. If you have not change password setting for web interface, enter the factory default user "**root**". When GRT prompts you for a password, type "**root**". More security issues for remote management interfaces, please refer to section 3.15 Management Security.



3.3 Web operation and Quick Installation Guide

3.3.1 Bridge Mode

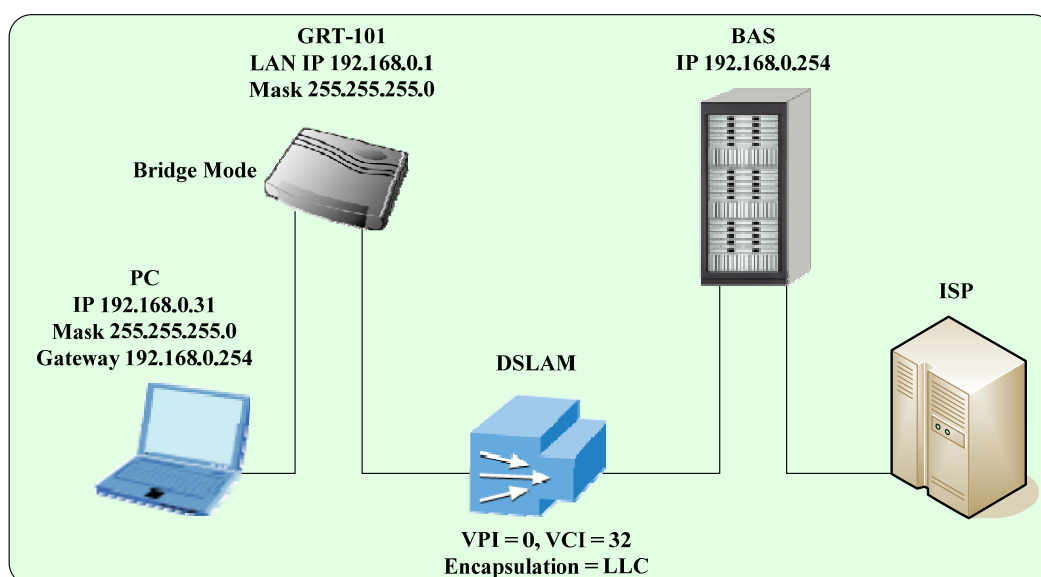

Web UI Configuration

After connection via web browser, click **BRIDGE** and **CPE Side** to setup Bridging mode of GRT series and then click **Next** for the next setting.

Home	Basic	Advanced	Status	Admin	Utility
BASIC - STEP1					
Operation Mode:					
System Mode: <input type="radio"/> ROUTE <input checked="" type="radio"/> BRIDGE					
SHDSL Mode: <input type="radio"/> CO Side <input checked="" type="radio"/> CPE Side					
<input type="button" value="Cancel"/> <input type="button" value="Reset"/> <input type="button" value="Next"/>					

1. Enter WAN1 VPI: 0 and VCI: 32.
2. Select WAN1 AAL5 Encap: **LLC**
3. Enter LAN IP: 192.168.0.1
4. Enter LAN Sub-net Mask: 255.255.255.0
5. Enter Gateway: 192.168.0.254
The Gateway is directly pointed to the BAS IP.
6. Click **Next**

Home	Basic	Advanced	Status	Admin	Utility
BASIC - STEP2					
LAN:					
IP Address: 192 . 168 . 0 . 1					
Subnet Mask: 255 . 255 . 255 . 0					
Gateway: 192 . 168 . 0 . 254					
Host Name: SOHO					
WAN1:					
VPI: 0					
VCI: 32					
Encap.: <input type="radio"/> VC-mux <input checked="" type="radio"/> LLC					
<input type="button" value="Back"/> <input type="button" value="Cancel"/> <input type="button" value="Reset"/> <input type="button" value="Next"/>					

7. The screen will prompt the new configured parameters. Check the parameters and click **Restart**, the router will reboot with the new setting or click **Continue** to configure other parameters.

Console Configuration

Do the following steps:

- 1 User : admin ← password: admin ←
- 2 enable ← supervisor password: root ←
- 3 setup ← mode ← *Bridge* ←
- 4 wan ← Interface number (1~8) : 1 ←
Protocol ← : *Ethernet* ←
vpi_vci : 0 ←
32 ←
encap : *LLC* ←
- 5 bridge ← gateway ← 192.168.0.254 ←
- 6 lan ← address ← 192.168.0.1 ←
255.255.255.0 ←
- 7 (back to root) write ← y ←
y ←(reboot)

3.3.2 Routing Mode for PPPoA and PPPoE with IP

Sharing

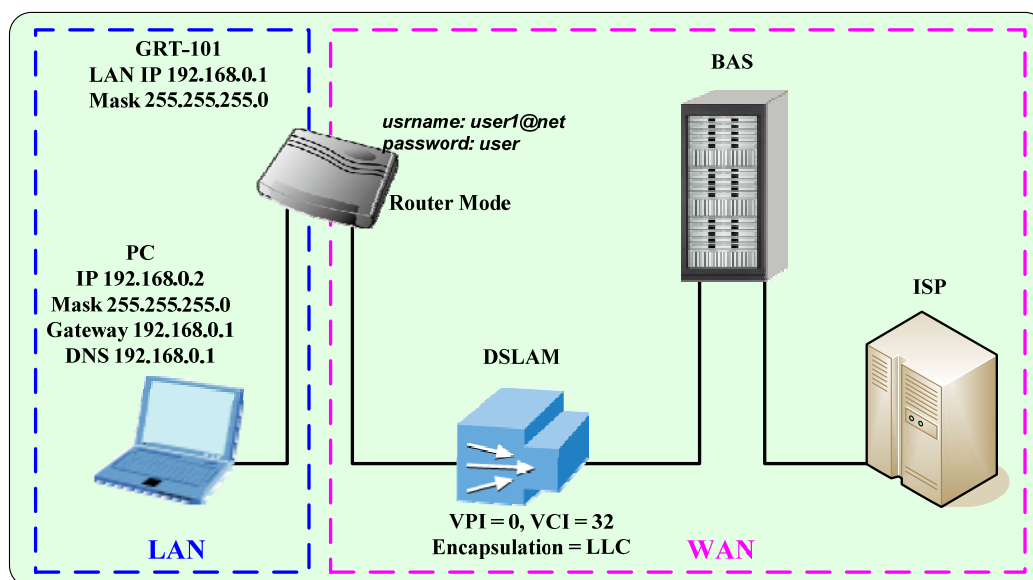

Web UI Configuration

For Route Mode with Point-to-Point Protocol over ATM and Ethernet, follow the following setting. First select **ROUTE** and **CPE Side**, and then click **Next** for setting others parameters.

Home	Basic	Advanced	Status	Admin	Utility
BASIC - STEP1					
Operation Mode:					
System Mode: <input checked="" type="radio"/> ROUTE <input type="radio"/> BRIDGE					
SHDSL Mode: <input type="radio"/> CO Side <input checked="" type="radio"/> CPE Side					
<input type="button" value="Cancel"/> <input type="button" value="Reset"/> <input type="button" value="Next"/>					

1. Enter LAN IP: 192.168.0.1
2. Enter LAN Sub-net Mask: 255.255.255.0
3. Host Name: SOHO
4. DHCP Server: Enable
5. Click **Next**

Home	Basic	Advanced	Status	Admin	Utility
BASIC - STEP2					
LAN:					
IP Type: <input checked="" type="radio"/> Fixed <input type="radio"/> Dynamic(DHCP Client)					
IP Address: <input type="text" value="192"/> . <input type="text" value="168"/> . <input type="text" value="0"/> . <input type="text" value="1"/>					
Subnet Mask: <input type="text" value="255"/> . <input type="text" value="255"/> . <input type="text" value="255"/> . <input type="text" value="0"/>					
Host Name: <input type="text" value="SOHO"/>					
Trigger DHCP Service: <input type="radio"/> Disable <input checked="" type="radio"/> Server <input type="radio"/> Relay					
<input type="button" value="Back"/> <input type="button" value="Cancel"/> <input type="button" value="Reset"/> <input type="button" value="Next"/>					

6. Enter DHCP Client Start IP: 192.168.0.2
7. Enter DHCP Client End IP: 192.168.0.51
8. Enter DNS Server: 192.168.0.1
9. The DNS server is embedded in GRT series.
10. Click **Next** to write the new setting.

Home	Basic	Advanced	Status	Admin	Utility
------	-------	----------	--------	-------	---------

BASIC - STEP3

DHCP SERVER:

- **General DHCP Parameter:**

Start IP Address: 192.168.0.

End IP Address: 192.168.0.

DNS Server 1:

DNS Server 2:

DNS Server 3:

Lease Time: hours
- **Table of Fixed DHCP Host Entries:**

Hint: The format of the MAC Address is 12:34:56:78:9A:BC

Index	MAC Address	IP Address
1	<input style="width: 90%;" type="text"/>	<input style="width: 90%;" type="text"/>
2	<input style="width: 90%;" type="text"/>	<input style="width: 90%;" type="text"/>
3	<input style="width: 90%;" type="text"/>	<input style="width: 90%;" type="text"/>

11. Enter WAN1 VPI: 0 and VCI: 32.
12. Select WAN1 AAL5 Encap: LLC
13. Select: PPPoA + NAT or PPPoE + NAT
14. Click Next

Home	Basic	Advanced	Status	Admin	Utility
------	-------	----------	--------	-------	---------

BASIC - STEP4

WAN1:

VPI:

VCI:

AAL5 Encap: VC-mux LLC

Protocol:

IPoA

IPoA+NAT

EoA

EoA+NAT

PPPoA+NAT

PPPoE+NAT

15. Enter user name provided by ISP: user1@net
16. Enter Password provided by ISP: user1
17. Re-enter Password for confirmation: user1

Home	Basic	Advanced	Status	Admin	Utility												
BASIC - STEP4																	
ISP1:																	
<table border="1"> <tr> <td>Username:</td> <td><input type="text" value="user1@net"/></td> </tr> <tr> <td>Password:</td> <td><input type="password" value="****"/></td> </tr> <tr> <td>Password Confirm:</td> <td><input type="password" value="****"/></td> </tr> <tr> <td>Idle Time:</td> <td><input type="text" value="10"/> minutes</td> </tr> <tr> <td>IP Type:</td> <td><input type="text" value="Dynamic"/></td> </tr> <tr> <td>IP Address:</td> <td><input type="text" value="192.168.1.1"/></td> </tr> </table>						Username:	<input type="text" value="user1@net"/>	Password:	<input type="password" value="****"/>	Password Confirm:	<input type="password" value="****"/>	Idle Time:	<input type="text" value="10"/> minutes	IP Type:	<input type="text" value="Dynamic"/>	IP Address:	<input type="text" value="192.168.1.1"/>
Username:	<input type="text" value="user1@net"/>																
Password:	<input type="password" value="****"/>																
Password Confirm:	<input type="password" value="****"/>																
Idle Time:	<input type="text" value="10"/> minutes																
IP Type:	<input type="text" value="Dynamic"/>																
IP Address:	<input type="text" value="192.168.1.1"/>																
<input type="button" value="Back"/> <input type="button" value="Cancel"/> <input type="button" value="Reset"/> <input type="button" value="Next"/>																	

18. The screen will prompt the new configured parameters. Check the parameters and click **Restart**, the router will reboot with the new setting or click **Continue** to configure other parameters.

Console Configuration

Do the following steps:

1. User : **admin** ← password: **admin** ←
2. enable ← supervisor password: **root** ←
3. setup ← mode ← **Route** ←
4. wan ← Interface number (1~8) : **1** ←
 protocol ← **PPPoA** or **PPPoE** ←
 vpi_vci: **0** ←
 32 ←
 encaps ← **LLC** ←
 isp ← account: **user1@net** ←
 password: **user1** ←
 idle time out: **0 ~ 600** ← (the unit is in minute)
5. lan ← address ← **192.168.0.1** ←
 255.255.255.0 ←
 attrib ← **Virtual** ←
6. (back to root) write ← **y** ←
 y ←(reboot)

3.3.3 Routing Mode for IPoA or EoA

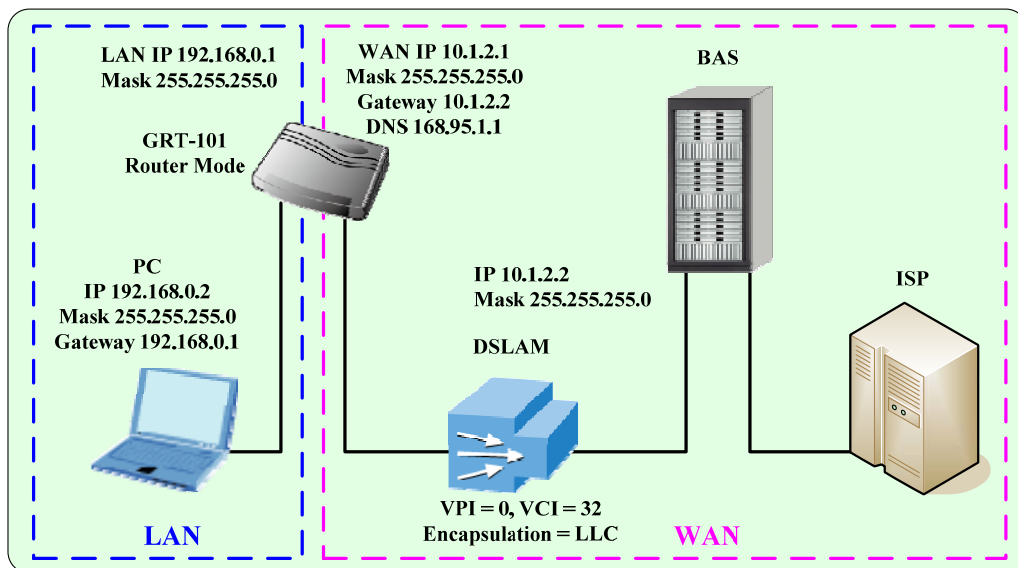

Web UI Configuration

For Route Mode with Classical IP over ATM and Ethernet over ATM, follow the following setting. First select **ROUTE** and **CPE Side**, and then click **Next** for setting others parameters.

Home	Basic	Advanced	Status	Admin	Utility
BASIC - STEP1					
Operation Mode:					
System Mode: <input checked="" type="radio"/> ROUTE <input type="radio"/> BRIDGE					
SHDSL Mode: <input type="radio"/> CO Side <input checked="" type="radio"/> CPE Side					
<input type="button" value="Cancel"/> <input type="button" value="Reset"/> <input type="button" value="Next"/>					

1. Enter LAN IP: 192.168.0.1
2. Enter LAN Sub-net Mask: 255.255.255.0
3. Host Name: SOHO
4. DHCP Server: Enable
5. Click **Next**

Home	Basic	Advanced	Status	Admin	Utility
BASIC - STEP2					
LAN:					
IP Type: <input checked="" type="radio"/> Fixed <input type="radio"/> Dynamic(DHCP Client)					
IP Address: <input type="text" value="192"/> <input type="text" value="168"/> <input type="text" value="0"/> <input type="text" value="1"/>					
Subnet Mask: <input type="text" value="255"/> <input type="text" value="255"/> <input type="text" value="255"/> <input type="text" value="0"/>					
Host Name: <input type="text" value="SOHO"/>					
Trigger DHCP Service: <input type="radio"/> Disable <input checked="" type="radio"/> Server <input type="radio"/> Relay					
<input type="button" value="Back"/> <input type="button" value="Cancel"/> <input type="button" value="Reset"/> <input type="button" value="Next"/>					

6. Enter DHCP Client Start IP: 192.168.0.2
7. Enter DHCP Client End IP: 192.168.0.51
8. Enter DNS Server: 192.168.0.1
9. The DNS server is embedded in GRT series.
10. Click **Next** to write the new setting.

BASIC - STEP3

DHCP SERVER:

- General DHCP Parameter:
 - Start IP Address: 192.168.0.2
 - End IP Address: 192.168.0.51
 - DNS Server 1: 192.168.0.1
 - DNS Server 2:
 - DNS Server 3:
 - Lease Time: 72 hours
- Table of Fixed DHCP Host Entries:

Hint: The format of the MAC Address is 12:34:56:78:9A:BC

Index	MAC Address	IP Address
1		
2		
3		

11. Enter WAN1 VPI: 0 and VCI: 32.
12. Select WAN1 AAL5 Encap: LLC
13. Select: IPoA, IPoA + NAT, EoA, or EoA + NAT
14. Click **Next**

BASIC - STEP4

WAN1:

VPI: 0
VCI: 32

AAL5 Encap: VC-mux LLC

Protocol: IPoA

- IPoA
- IPoA+NAT
- EoA
- EoA+NAT
- PPPoA+NAT
- PPPoE+NAT

Back Cancel Reset Next

15. Enter WAN1 IP: 10.1.2.1
16. Enter WAN1 Subnet Mask: 255.255.255.0
17. Enter Default Route Gateway: 10.1.2.2
18. Enter DNS Server: 168.95.1.1

Home	Basic	Advanced	Status	Admin	Utility		
BASIC - STEP5							
WAN1:							
IP Address:	10	.	1	.	2	.	1
Subnet Mask:	255	.	255	.	255	.	0
Gateway:	10	.	1	.	2	.	2
DNS Server 1:	168.95.1.1						
DNS Server 2:							
DNS Server 3:							
<input type="button" value="Back"/> <input type="button" value="Cancel"/> <input type="button" value="Reset"/> <input type="button" value="Next"/>							

19. The screen will prompt the new configured parameters. Check the parameters and click **Restart**, the router will reboot with the new setting or click **Continue** to configure other parameters.

Console Configuration

Do the following steps:

1. User : admin ← password: admin ←
2. enable ← supervisor password: root ←
3. setup ← mode ← *Route* ←
4. wan ← Interface number (1~8) : 1 ←
 - protocol ← *IPoA* or *EoA* ←
 - address ← 10.1.2.1 ←
 - 255.255.255.0 ←
 - vpi_vci: 0 ←
 - 32 ←
 - encap ← *LLC* ←
5. lan ← address ← 192.168.0.1 ←
 - 255.255.255.0 ←
 - attrib ← *virtual* ←
6. route ← static ← add ←
 - IP address: 0.0.0.0
 - Subnet mask: 0.0.0.0
 - Gateway: 10.1.2.2
7. (back to root) write ← y ←
 - y ← (reboot)

3.3.4 LAN-to-LAN Connection with Bridge Mode

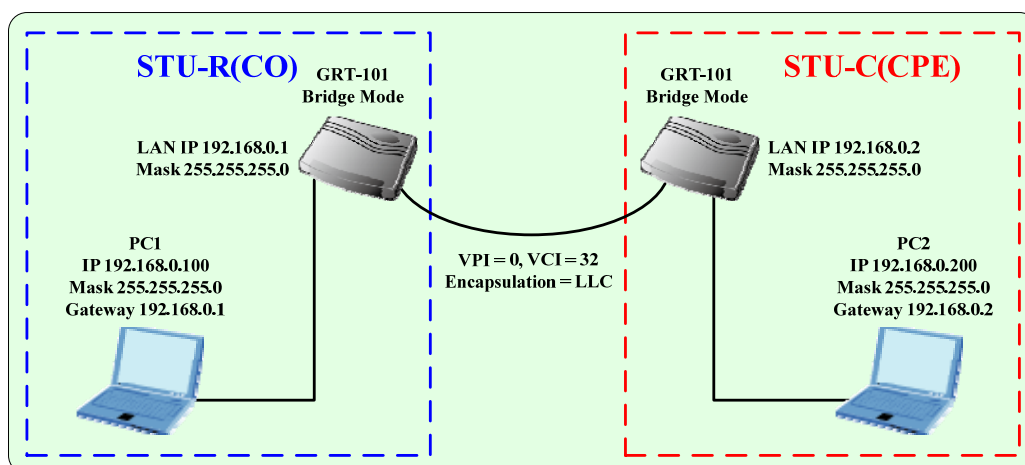

Web UI Configuration

STU-R (CO) side

Click setup to setup the **BRIDGE** as **CO Side**. Follow the instruction.

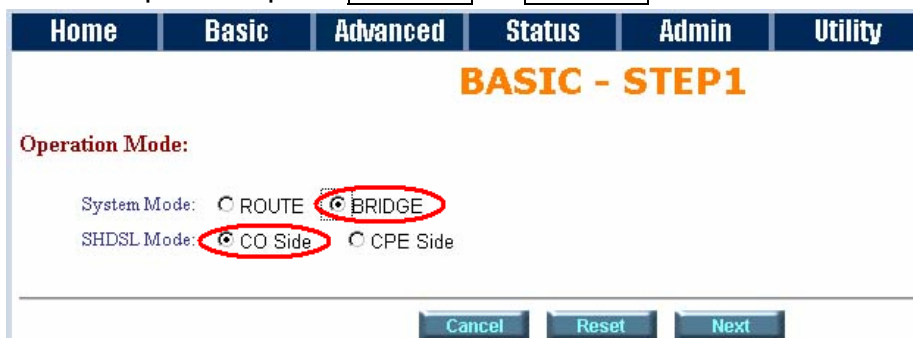

1. Enter WAN1 VPI: 0 and VCI: 32.
2. Select WAN1 AAL5 Encap: LLC
3. Enter LAN IP: 192.168.0.1
4. Enter LAN Sub-net Mask: 255.255.255.0
5. Enter Gateway: 192.168.0.2
6. Click Next

Home	Basic	Advanced	Status	Admin	Utility
------	-------	----------	--------	-------	---------

BASIC - STEP2

LAN:

IP Address: 192 . 168 . 0 . 1
 Subnet Mask: 255 . 255 . 255 . 0
 Gateway: 192 . 168 . 0 . 2
 Host Name: SOHO

WAN1:

VPI: 0
 VCI: 32
 Encap.: VC-mux LLC

7. Setup the CO Router in bridge mode (refer to bridge mode in section 2.1). The gateway of CO Router is pointed to LAN IP, 192.168.0.2, of CPE Router.

Home	Basic	Advanced	Status	Admin	Utility
------	-------	----------	--------	-------	---------

BASIC - STEP1

Operation Mode:

System Mode: ROUTE BRIDGE
 SHDSL Mode: CO Side CPE Side

Home	Basic	Advanced	Status	Admin	Utility
------	-------	----------	--------	-------	---------

BASIC - STEP2

LAN:

IP Address: 192 . 168 . 0 . 2
 Subnet Mask: 255 . 255 . 255 . 0
 Gateway: 192 . 168 . 0 . 1
 Host Name: SOHO

WAN1:

VPI: 0
 VCI: 32
 Encap.: VC-mux LLC

STU-C (CPE) side

Follow the above instruction. The only difference in this configuration is that users have to choose CPE SIDE instead of CO SIDE.

Setup the CPE Router in bridge mode. The gateway of CPE Router is pointed to LAN IP, 192.168.0.1, of CO Router.

Console Configuration

Do the following steps in STU-R side:

1. User : admin ← password: admin ←
2. enable ← supervisor password: root ←
3. setup ← mode ← Bridge ←
shdsl ← STU-R ←
4. wan ← Interface number (1~8) : 1 ←
Protocol ← : Ethernet ←
vpi_vci: 0 ←
encap: LLC ←
32 ←
5. lan ← address ← 192.168.0.1 ←
255.255.255.0 ←
6. (back to root) write ← y ←
y ←(reboot)

Do the following steps in STU-C side:

1. User : admin ← password: admin ←
2. enable ← supervisor password: root ←
3. setup ← mode ← Bridge ←
shdsl ← STU-C ←
4. wan ← Interface number (1~8) : 1 ←
Protocol ← : Ethernet ←
vpi_vci : 0 ←
33 ←
encap : LLC ←
5. lan ← address ← 192.168.0.2 ←
255.255.255.0 ←
6. (back to root) write ← y ←
y ←(reboot)

3.3.5 Advanced Setup

Advanced configuration contains SHDSL, WAN, Bridge, Route, NAT/DMZ and Virtual server parameters.

SHDSL

You can setup the Annex type, data rate and SNEXT margin for SHDSL parameters in SHDSL.

Click [SHDSL](#)

Annex Type: There are three Annex types, Annex A, Annex B and Annex AB in SHDSL.

Link Type: For GRT-402 only, support two link type, 4-wire mode with 4.608 Mbps data rate and 2-wire mode with 2.304 Mbps data rate.

Data Rate: you can setup the SHDSL data rate in the multiple of 64kbps.

SHDSL SNEXT margin: the margin range is from -10 to 10.

Home **Basic** **Advanced** **Status** **Admin** **Utility**

ADVANCED - SHDSL

Operation Mode:

- Setup Operation Mode:
 - Annex Type: Annex A Annex B Annex AB
 - Data Rate(n*64kbps): (range:0~36, n=0 for adaptive mode)
 - SNR margin: (range:-10~10)

The screen will prompt the parameters that will be written in machine. Be sure to confirm the modified parameters before rebooting and activating these changes in GRT series.

Press Restart button to restart GRT series working with new parameters or press continue to setup another parameter.

Home **Basic** **Advanced** **Status** **Admin** **Utility**

ADVANCED - SHDSL

SHDSL Parameters Review:
To let the configuration that you have changed take effect immediately, please click **Restart** button to rebo. continue the setup procedure, please click **Continue** button.

- SHDSL Mode:

Annex Type	Annex A
Data Rate	0 (adaptive mode)
SNEXT margin	0

WAN

GRT series supports up to 8 PVCs for WAN connections. You may specify

these parameters in WAN configuration menu. The WAN Number 1 will be the parameters setup in Basic Setup. If you want to setup another PVC, you can configure them in WAN 2 to WAN 8.

Please enter the necessary parameters.

After inserting the parameters, please press **Finish** to complete WAN configuration.

The screen will prompt the parameters that will be written in GRT series. Please confirm these parameters before writing in machine.

Home
Basic
Advanced
Status
Admin
Utility

ADVANCED - WAN

WAN Interface Parameters:

■ **Table of Current WAN Interface Parameter:**

No	WAN	VC	ISP
1	Protocol: IP over ATM IP Address: 10.1.2.1 Subnet Mask: 255.255.255.0	VPI: 0 VCI: 32 AAL5 Encap: LLC QoS Class: UBR QoS PCR: 2400	Username: test Password: **** Password Confirm: **** Idle Time: 10
2	Protocol: Disable IP Address: 192.168.2.1 Subnet Mask: 255.255.255.0	VPI: 0 VCI: 33 AAL5 Encap: LLC QoS Class: UBR QoS PCR: 2400	Username: test Password: **** Password Confirm: **** Idle Time: 10
3	Protocol: Disable IP Address: 192.168.3.1 Subnet Mask: 255.255.255.0	VPI: 0 VCI: 34 AAL5 Encap: LLC QoS Class: UBR QoS PCR: 2400	Username: test Password: **** Password Confirm: **** Idle Time: 10
4	Protocol: Disable IP Address: 192.168.4.1 Subnet Mask: 255.255.255.0	VPI: 0 VCI: 35 AAL5 Encap: LLC QoS Class: UBR QoS PCR: 2400	Username: test Password: **** Password Confirm: **** Idle Time: 10
5	Protocol: Disable IP Address: 192.168.5.1 Subnet Mask: 255.255.255.0	VPI: 0 VCI: 36 AAL5 Encap: LLC QoS Class: UBR QoS PCR: 2400	Username: test Password: **** Password Confirm: **** Idle Time: 10
6	Protocol: Disable IP Address: 192.168.6.1 Subnet Mask: 255.255.255.0	VPI: 0 VCI: 37 AAL5 Encap: LLC QoS Class: UBR QoS PCR: 2400	Username: test Password: **** Password Confirm: **** Idle Time: 10
7	Protocol: Disable IP Address: 192.168.7.1 Subnet Mask: 255.255.255.0	VPI: 0 VCI: 38 AAL5 Encap: LLC QoS Class: UBR QoS PCR: 2400	Username: test Password: **** Password Confirm: **** Idle Time: 10
8	Protocol: Disable IP Address: 192.168.8.1 Subnet Mask: 255.255.255.0	VPI: 0 VCI: 39 AAL5 Encap: LLC QoS Class: UBR QoS PCR: 2400	Username: test Password: **** Password Confirm: **** Idle Time: 10

Home
Basic
Advanced
Status
Admin
Utility

ADVANCED - WAN

WAN Interface Parameters Review:

To let the configuration that you have changed take effect immediately, please click **Restart** button to reb continue the setup procedure, please click **Continue** button.

■ **WANI Interface:**

Protocol	IP over ATM
IP Address	10.1.2.1
Subnet Mask	255.255.255.0
VPI/VCI	0/32
Encapsulation	LLC
QoS Class	UBR
QoS PCR	2400
ISP Username	test
ISP Password	****
Idle Time	10

Continue
Restart

Press Restart to restart GRT series working with new parameters or press continue to setup another parameter.

Bridge

The bridge mode can be setup the static bridge parameters. Click **Bridge** to start Bridge configuration.

Press **Add** to add the static bridge information.

ADVANCED - BRIDGE

Generic Bridge Parameters:

- General Parameter:
 - Default Gateway:

Static Bridge Parameters:

- Table of Current MAC Entries:

No	MAC Address	LAN	WAN1 - 4	WAN5 - 8
1	00:00:00:00:00:00	Filter	1. Filter 2. Filter 3. Filter 4. Filter	5. Filter 6. Filter 7. Filter 8. Filter

The screen will prompt the parameters that will be written in GRT series. Check the parameters before writing in machine.

Press **Restart** to restart GRT series working with new parameters or press **continue** to setup another parameter.

ADVANCED - BRIDGE

Bridge Parameters Review:

To let the configuration that you have changed take effect immediately, please click **Restart** button to reboot the sys continue the setup procedure, please click **Continue** button.

- Generic Bridge Parameter:
 - Default Gateway:
- Static Bridge Parameter:

No	MAC Address	LAN	WAN1	WAN2	WAN3	WAN4	WAN5	WAN6	WAN7	WAN8
Pool is Empty !										

Route

If GRT series is connected to more than one network, it may be necessary to set up a static route between them. A static route is a pre-determined pathway that network information must travel to reach a specific host or network.

With Dynamic Routing, you can enable GRT series to automatically adjust to physical changes in the network's layout. The Cable/DSL Firewall Router, using the RIP protocol, determines the network packets' route based on the fewest number of hops between the source and the destination. The RIP protocol regularly broadcasts routing information to other routers on the network.

Click **Route** to modify the routing information.

Home Basic **Advanced** Status Admin Utility

ADVANCED - ROUTE

Static Route and RIP Parameters:

- Table of Current Static Route Entries:

Index	Network Address	Subnet Mask	Gateway
1	0.0.0.0	0.0.0.0	10.1.2.2
2			
- General RIP Parameter:

RIP Mode: Disable Enable
 Auto RIP Summary: Disable Enable
- Table of Current Interface RIP Parameter:

Interface	RIP Mode	Version	Authentication Required	Poison Reverse	Authentication Code
LAN	Disable	2	None	Enable	None
WAN1	Disable	2	None	Enable	None
WAN2	Disable	--	None	Disable	None
WAN3	Disable	--	None	Disable	None

Home Basic **Advanced** Status Admin Utility

- General RIP Parameter:

RIP Mode: Disable Enable
 Auto RIP Summary: Disable Enable
- Table of Current Interface RIP Parameter:

Interface	RIP Mode	Version	Authentication Required	Poison Reverse	Authentication Code
LAN	Disable	2	None	Enable	None
WAN1	Disable	2	None	Enable	None
WAN2	Disable	--	None	Disable	None
WAN3	Disable	--	None	Disable	None
WAN4	Disable	--	None	Disable	None
WAN5	Disable	--	None	Disable	None
WAN6	Disable	--	None	Disable	None
WAN7	Disable	--	None	Disable	None
WAN8	Disable	--	None	Disable	None

To modify the RIP (Routing information protocol) Parameters:
 RIP Mode: **Enable**
 Auto RIP Summary: **Enable**
 Press **Modify**

RIP Mode: this parameter determines how the product handle RIP (Routing information protocol). RIP allows it to exchange routing information with other router. If set to Disable, the gateway does not participate in any RIP exchange with other router. If set Enable, GRT series broadcasts the routing table of GRT series on the LAN and incorporates RIP broadcast by other routers into it's routing table. If set silent, GRT series does not broadcast the routing table, but it accepts RIP broadcast packets that it receives.

Table of Current Interface RIP Parameter:

Interface	RIP Mode	Version	Authentication Required	Poison Reverse	Authentication Code
LAN	Disable	2	None	Enable	
WAN1	Disable	2	None	Enable	None
WAN2	Enable	--	None	Disable	None
WAN3	Silent	--	None	Disable	None
WAN4	Disable	--	None	Disable	None
WAN5	Disable	--	None	Disable	None
WAN6	Disable	--	None	Disable	None
WAN7	Disable	--	None	Disable	None
WAN8	Disable	--	None	Disable	None

RIP Version: It determines the format and broadcasting method of any RIP transmissions by the gateway.
RIP v1: it only sends RIP v1 messages only.
RIP v2: it send RIP v2 messages in multicast and broadcast format.

Table of Current Interface RIP Parameter:

Interface	RIP Mode	Version	Authentication Required	Poison Reverse	Authentication Code
LAN	Disable	2	None	Enable	
WAN1	Disable	1	None	Enable	None
WAN2	Disable	2	None	Disable	None
WAN3	Disable	--	None	Disable	None
WAN4	Disable	--	None	Disable	None
WAN5	Disable	--	None	Disable	None
WAN6	Disable	--	None	Disable	None
WAN7	Disable	--	None	Disable	None
WAN8	Disable	--	None	Disable	None

Authentication required.
None: for RIP, there is no need of authentication code.
Password: the RIP is protected by password, authentication code.
MD5: The RIP will be decoded by MD5 than protected by password, authentication code.

Table of Current Interface RIP Parameter:

Interface	RIP Mode	Version	Authentication Required	Poison Reverse	Authentication Code
LAN	Disable	2	None	Enable	
WAN1	Disable	2	None	Enable	None
WAN2	Disable	--	Password	Disable	None
WAN3	Disable	--	MD5	Disable	None
WAN4	Disable	--	None	Disable	None
WAN5	Disable	--	None	Disable	None
WAN6	Disable	--	None	Disable	None
WAN7	Disable	--	None	Disable	None
WAN8	Disable	--	None	Disable	None

Poison Reserve is for the purpose of promptly broadcast or multicast the RIP while the route is changed. (ex shutting down one of GRT series in routing table)
Enable: machine will actively broadcast or multicast the information.
Disable: machine will not broadcast or multicast the information.

Table of Current Interface RIP Parameter:

Interface	RIP Mode	Version	Authentication Required	Poison Reverse	Authentication Code
LAN	Disable	2	None	Enable	
WAN1	Disable	2	None	Disable	None
WAN2	Disable	--	None	Enable	None
WAN3	Disable	--	None	Disable	None
WAN4	Disable	--	None	Disable	None
WAN5	Disable	--	None	Disable	None
WAN6	Disable	--	None	Disable	None
WAN7	Disable	--	None	Disable	None
WAN8	Disable	--	None	Disable	None

After modifying the RIP parameters, press **finish**.
 The screen will prompt the modified parameter. Check the parameters and perss **Restart** to restart GRT series or press **Continue** to setup another parameters.

NAT/DMZ

NAT (Network Address Translation) is the translation of an Internet Protocol address (IP address) used within one network to a different IP address known within another network. One network is designated the inside network and the other is the outside. Typically, a company maps its local inside network addresses to one or more global outside IP addresses and reverse the global IP addresses of incoming packets back into local IP addresses. This ensure security since each outgoing or incoming request must go through a translation process, that also offers the opportunity to qualify or authenticate the request or match it to a previous request. NAT also conserves on the number of global IP addresses that a company needs and lets the company to use a single IP address of its communication in the Internet world.

DMZ (demilitarized zone) is a computer host or small network inserted as a “neutral zone” between a company private network and the outside public network. It prevents outside users from getting direct access to a server that has company private data.

In a typical DMZ configuration for an enterprise, a separate computer or host receives requests from users within the private network to access via Web sites or other companies accessible on the public network. The DMZ host then initiates sessions for these requests to the public network. However, the DMZ host is not able to initiate a session back into the private network. It can only forward packets that have already been requested.

Users of the public network outside the company can access only the DMZ host. The DMZ may typically also have the company's Web pages so these could serve the outside world. However, the DMZ provides access to no other company data. In the event that an outside user penetrated the DMZ host's security, the Web pages might be corrupted, but no other company information would be exposed.

Press **NAT/DMZ** to setup the parameters.

If you want to enable the NAT/DMZ functions, click Enable. Enable the DMZ host Function is used the IP address assigned to the WAN for enabling DMZ function for the virtual IP address.

Multi-DMZ: Some users who have two or more global IP addresses assigned by ISP can be used the multi DMZ. The table is for the mapping of global IP address and virtual IP address.

Multi-NAT: Some of the virtual IP

Home	Basic	Advanced	Status	Admin	Utility
ADVANCED - NAT/DMZ					
Network Address Translation and DMZ Hosts Parameters:					
■ NAT/DMZ function:					
NAT/DMZ Function: <input checked="" type="radio"/> Disable <input type="radio"/> Enable					
■ DMZ Host:					
DMZ Host Function: <input checked="" type="radio"/> Disable <input type="radio"/> Enable					
Virtual IP Address: <input type="text"/>					
Active Interface: <input type="text" value="WAN1"/>					
■ Multi-DMZ:					
ID	Virtual IP Address	Global IP Address	Interface		
1	<input type="text"/>	<input type="text"/>	<input type="text" value="WAN1"/>		
2	<input type="text"/>	<input type="text"/>	<input type="text" value="WAN1"/>		
3	<input type="text"/>	<input type="text"/>	<input type="text" value="WAN1"/>		
4	<input type="text"/>	<input type="text"/>	<input type="text" value="WAN1"/>		
5	<input type="text"/>	<input type="text"/>	<input type="text" value="WAN1"/>		
6	<input type="text"/>	<input type="text"/>	<input type="text" value="WAN1"/>		

addresses (eg: 192.168.0.10 ~ 192.168.0.50) collectively use two of the global IP addresses (eg: 69.210.1.9 and 69.210.1.10). The Multi-NAT table will be setup as;

Virtual Start IP Address: 192.168.0.10
 Count: 40
 Global Start IP Address: 69.210.1.9
 Count: 2

Press **Finish** to continue.

The screen will prompt the parameters that will be written in GRT series. Check the parameters before writing in GRT series. Press

Restart to restart GRT series working with new parameters or **Continue** to configure another parameter.

7	<input type="text"/>	<input type="text"/>	WAN1
8	<input type="text"/>	<input type="text"/>	WAN1
9	<input type="text"/>	<input type="text"/>	WAN1
10	<input type="text"/>	<input type="text"/>	WAN1

■ Multi-NAT:

ID	Virtual Start IP Address	Count	Global Start IP Address	Count	Interface
1	<input type="text"/>	<input type="text"/>	<input type="text"/>	<input type="text"/>	WAN1
2	<input type="text"/>	<input type="text"/>	<input type="text"/>	<input type="text"/>	WAN1
3	<input type="text"/>	<input type="text"/>	<input type="text"/>	<input type="text"/>	WAN1
4	<input type="text"/>	<input type="text"/>	<input type="text"/>	<input type="text"/>	WAN1
5	<input type="text"/>	<input type="text"/>	<input type="text"/>	<input type="text"/>	WAN1

Virtual Server

For example: Specific ports on the WAN interface are re-mapped to services inside the LAN. As only 69.210.1.8 (e.g., assigned to WAN from ISP) is visible to the Internet, but does not actually have any services (other than NAT of course) running on gateway, it is said to be a virtual server. Request with TCP made to 69.210.1.8:80 are remapped to the server 1 on 192.168.0.2:80, other requests with UDP made to 69.210.1.8:25 are remapped to server 2 on 192.168.0.3:25.

Click **Virtual Server** to configure the parameters.

Type the necessary parameters then click **Finish**.

Press **Restart** to restart GRT series or press **continue** to setup another function.

Home Basic **Advanced** Status Admin Utility

ADVANCED - VIRTUAL SERVER

Virtual Server Mapping Parameters:

■ Table of Current Virtual Server Entries:

Index	Protocol	Interface	Service Name	Port Number	Server IP Address	Server Port Number
1	DISABLE	WAN1	<input type="text"/>	<input type="text"/>	<input type="text"/>	<input type="text"/>
2	DISABLE	WAN1	<input type="text"/>	<input type="text"/>	<input type="text"/>	<input type="text"/>
3	DISABLE	WAN1	<input type="text"/>	<input type="text"/>	<input type="text"/>	<input type="text"/>
4	DISABLE	WAN1	<input type="text"/>	<input type="text"/>	<input type="text"/>	<input type="text"/>
5	DISABLE	WAN1	<input type="text"/>	<input type="text"/>	<input type="text"/>	<input type="text"/>
6	DISABLE	WAN1	<input type="text"/>	<input type="text"/>	<input type="text"/>	<input type="text"/>
7	DISABLE	WAN1	<input type="text"/>	<input type="text"/>	<input type="text"/>	<input type="text"/>
8	DISABLE	WAN1	<input type="text"/>	<input type="text"/>	<input type="text"/>	<input type="text"/>
9	DISABLE	WAN1	<input type="text"/>	<input type="text"/>	<input type="text"/>	<input type="text"/>
10	DISABLE	WAN1	<input type="text"/>	<input type="text"/>	<input type="text"/>	<input type="text"/>

3.3.6 Administration

This session introduces security and simple network management protocol (SNMP) and time synchronous.

Security

For system security, suggest to change the default user name and password in the first setup otherwise unauthorized persons can access GRT series and change the parameters.

There are three ways to configure GRT series, Web browser, telnet and serial console.

Press **Security** to setup the parameters.

For greater security, change the Supervisor ID and password for the gateway. If you don't set them, all users on your network can be able to access the gateway using the default IP and Password root.

You can authorize five legal users to access GRT series via telnet or console. There are two UI modes, menu driven mode and command mode to configure GRT series.

Legal address pool will setup the legal IP addresses from which authorized person can configure the gateway. This is the more secure function for network administrator to setup the legal address of configuration.

Click **Finish** to finish the setting.

The browser will prompt the configured parameters and check it before writing into GRT series.

Press **Restart** to restart the gateway working with the new parameters and press **Continue** to setup other parameters.

ADMIN - SECURITY

Supervisor Profile and Security Parameters:

- Supervisor ID and Password:**

Supervisor ID:

Supervisor Password:

Password Confirm:
- User Profile:**

ID	User Name	User Password	Password Confirm	UI Mode
1	admin	****	****	Menu
2	<input type="text"/>	<input type="password"/>	<input type="password"/>	Command
3	<input type="text"/>	<input type="password"/>	<input type="password"/>	Command
4	<input type="text"/>	<input type="password"/>	<input type="password"/>	Command
5	<input type="text"/>	<input type="password"/>	<input type="password"/>	Command
- General Parameters:**

Telnet Port:
- Trust Host List:**

ID	IP Address
1	<input type="text"/>
2	<input type="text"/>
3	<input type="text"/>
4	<input type="text"/>
5	<input type="text"/>
6	<input type="text"/>
7	<input type="text"/>
8	<input type="text"/>
9	<input type="text"/>
10	<input type="text"/>

Cancel Reset Finish

SNMP

Simple Network Management Protocol (SNMP) is the protocol not only governing network management, but also the monitoring of network devices and their functions.

GRT series can generate SNMP traps to indicate alarm conditions, and it relies on SNMP community strings to implement SNMP security. This gateway support MIB II.

Click **SNMP** to configure the parameters.

In the table of current community pool, you can setup the access authority.

In the table of current trap host pool, you can setup the trap host.

Press **Modify** to modify the community pool.

ADMIN - SNMP

SNMP Community and Trap Parameters:

- Table of current community pool:

Index	Status	Access Right	Community
1	Disable	---	---
2	Disable	---	---
3	Disable	---	---
4	Disable	---	---
5	Disable	---	---

Modify

- Table of current trap host pool:

Index	Version	IP Address	Community
1	Disable	---	---
2	Disable	---	---
3	Disable	---	---
4	Disable	---	---
5	Disable	---	---

Modify

Save Apply

SNMP status: Enable

SNMP Community and Trap Parameters:

- Table of current community pool:

Index	Status	Access Right	Community
1	Disable	Deny	private
2	Disable	---	---
3	Disable	---	---
4	Disable	---	---
5	Disable	---	---

Ok Cancel

Access Right: Deny for deny all access
 Access Right: Read for access read only
 Access Right: Write for access read and write.
 Community: it serves as password for

SNMP Community and Trap Parameters:

- Table of current community pool:

Index	Status	Access Right	Community
1	Disable	Deny	private
2	Disable	Deny	---
3	Disable	Read	---
4	Disable	Write	---
5	Disable	---	---

Ok Cancel

access right.

After configuring the community pool, press **OK**.

Click **Modify** to modify the trap host pool.

Version: select version for trap host.

IP: type the trap host IP

Community: type the community password.

Press **OK** to finish the setup.

Table of current trap host pool:

Index	Version	IP Address	Community
1	Disable	192.168.0.254	private
2	Disable	---	---
3	Version 1 Version 2	---	---
4	Disable	---	---
5	Disable	---	---

The browser will prompt the configured parameters and check it before writing into GRT series.

Press **Restart** to restart the gateway working with the new parameters and press **Continue** to setup other parameters.

Time Sync

Time synchronization is an essential element for any business that relies on an IT system. The reason for this is that these systems all have clocks that are the source of time for files or operations they handle. Without time synchronization, time on these systems varies with each other or with the correct time and this can cause-, firewall packet filtering schedule processes to fail, security to be compromised, system log exposures with wrong data.

Click **TIME SYNC**.

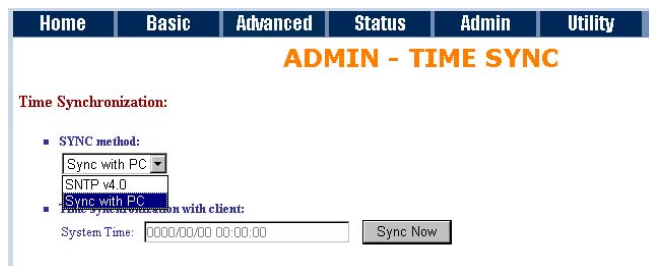

There are two synchronization modes: Simple Network Time Protocol (SNTP) and synchronization with PC. For synchronization with PC, select Sync with PC. The gateway will synchronize the time with the connecting PC.

SNTP is the acronym for Simple Network Time Protocol, which is an adaptation of the Network Time Protocol (NTP) used to synchronize computer clocks in



the Internet. SNTP can be used when the ultimate performance of the full NTP implementation.

For SNTP, select SNTP v4.0.

SNTP service: Enable

Time Server: All of the time server around the world can be used but suggest to use the time server nearby.

Time Zone: you have to choose the right time zone.

Press Finish to finish the setup. The browser will prompt the configured parameters and check it before writing into GRT series.

Config Tool

This configuration tool has three functions: load Factory Default, Restore Configuration and Backup Configuration.

Press **Config Tool**.

Choose the function and then press finish.

- Load Factory Default function: it will load the factory default parameters to the gateway.

Note: If this function is chosen, and activated. All of the settings in GRT series will be restored to factory default configurations.

- Restore Configuration: Sometime the configuration will be crushed unintentionally. Restore configuration will help you to recover the backup configuration easily.
 - ✧ Click Finish after selecting Restore Configuration.
 - ✧ Browse the route of backup file then press finish. GRT series will automatically restore the saved configuration.
- Backup Configuration: After configuration, suggest to use the function to backup your router parameters in the PC.
 - ✧ Select the Backup Configuration and then press Finish.

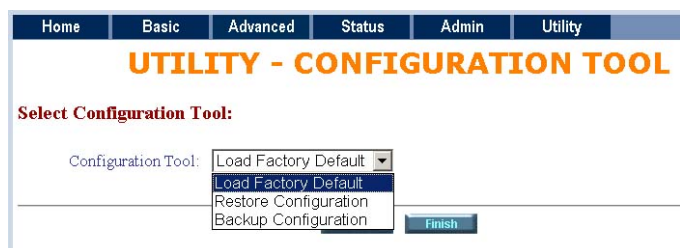

Browse the place of backup file named backup. Press Finish. GRT series will automatically backup the configuration.

Upgrade

You can upgrade the gateway using the upgrade function. Press **Upgrade**.

Browse the file and press OK button to upgrade. The system will reboot automatically after finishing.



Restart

For restarting GRT series, click the **Restart** in UTILITY menu.

Press **Restart** to reboot GRT series.



3.3.7 Status

You can monitor the SHDSL status including mode, Tx power and Bitrate and Performance information including SNR margin, attenuation and CRC error count.

LAN status will prompt the MAC address, IP address, Subnet mask and DHCP client table.

WAN status will display the WAN interface information.

You can view the routing table in the status of route.

Interface status includes LAN and WAN statistics information.

3.4 Command Line Interface

For serial console and Telnet management, GRT series implements two operational interfaces: command line interface (CLI) and menu driven interface. The CLI mode provides users a simple interface, which is better for working with script file. The menu driven interface is a user-friendly interface to general operations. The command syntax for CLI is the same as that of the menu driven interface. The only difference is that the menu driven interface shows you all of available commands for you to select. You don't need to remember the command syntax and save your time on typing the whole command line.

The following figure gives you an example of the menu driven interface. In the menu, you scroll up/down by pressing key `↑` / `↓`, select one command by key `→`, and go back to a higher level of menu by key `←`. For example, to show the system information, just logon to GRT series, move down the cursor by pressing key `↓` twice and select "show" command by key `→`, you shall see a submenu and select "system" command in this submenu, then the system will show you the general information.

In this chapter, all configuration procedures are explained by command line examples with necessary parameters. When operating in the menu driven interface, just select the corresponding command items from the menu hierarchy to configure the same setting.

Note: GRT series invokes menu driven interface when first time logon with default user profile "admin". Both

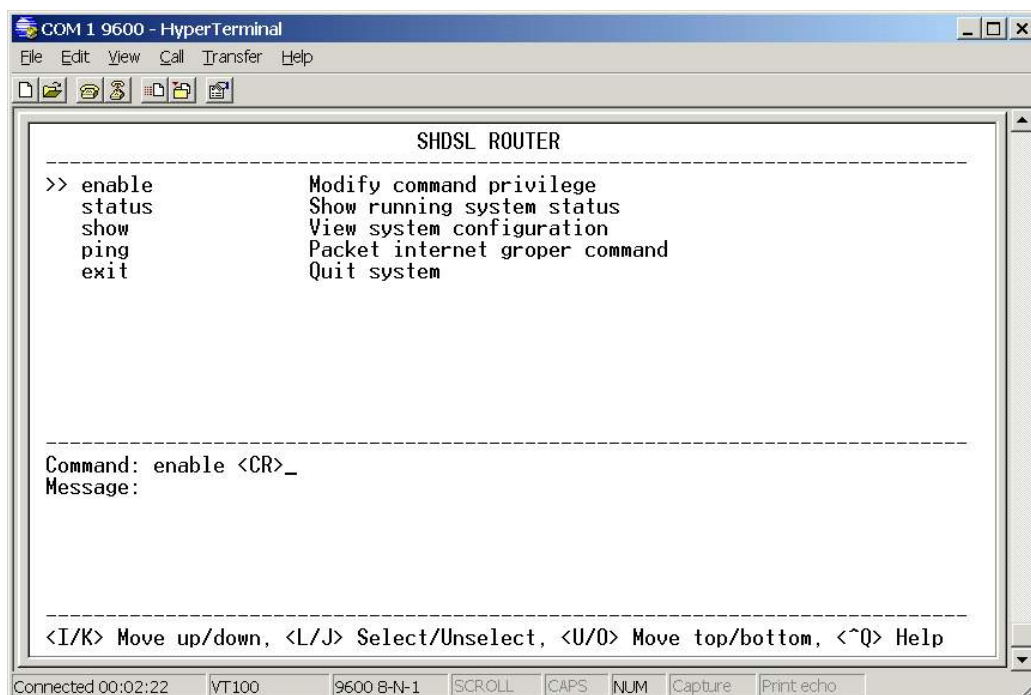

interfaces have on-line help information. To get on-line help, type "?" for CLI mode or press **CTRL+Q** for menu driven interface.

3.4.1 Multi-level password protection

When you login via serial console or Telnet, GRT series defaults to a program execution (read-only) privileges to you. To change the configuration and write changes to nonvolatile RAM (NVRAM), you must work in **enable** mode. Follow the steps below to invoke the **enable** mode:

```
admin> enable
```

```
Supervisor password: ****
```

Note: The supervisor password is the same as that for web management interface. If you have not change password setting for the web interface of GRT series, enter "**root**" to enter GRT series. For more security issues for remote management interfaces such as Telnet and web interface, see section 3.15 Management Security.

You are now in enable mode. The system prompt appears:

```
admin#
```

Follow the steps below to change the user interface:

To select menu driven interface for user profile 1 (default user profile), enter:

```
admin# admin user modify 1 attrib menu
```

The following command select CLI mode for user profile 1:

```
admin# admin user modify 1 attrib command
```

To save your changes enter:

```
admin# write
```

To enable your changes, reboot the system:

```
admin# reboot
```

For the menu interface, there is a method to enable CLI mode temporarily for script input. By pressing **CTRL+U** simultaneously, you can see the CLI system prompt in the command line window:

Command Line Window...

```
admin#
```

Press **CTRL+U** again in the command line window to back to the menu driven

interface.

Note: See section 3.14 User Profile for more information on how to add, delete, modify, and list user profile.

3.4.2 Menu Driven Command Line Interface

Before applying any changes into machine, it is suggested to ensure the modifications, and operations in GRT series' CLI menu driven configurations. Following table is the main CLI menu.

Keystroke	Description
[UP] or I	Move to above field in the same level menu.
[DOWN] or K	Move to below field in the same lever menu.
[LEFT] or J	Move back to previous menu.
[RIGHT] or L	Move forward to submenu.
[ENTER]	Move forward to submenu.
[TAB]	To choose another parameters.
Ctrl + C	To quit the configuring item.
Ctrl + Q	For help

3.4.3 Command Line Interface Menu Tree

Command line menu tree are shown in the following figures. All of the configuration commands are placed in the subdirectories of Enable protected by supervisor password. On the other hand, unauthorized user cannot change any configurations but viewing the status and configuration of GRT series and using ping command to make sure machine network status.

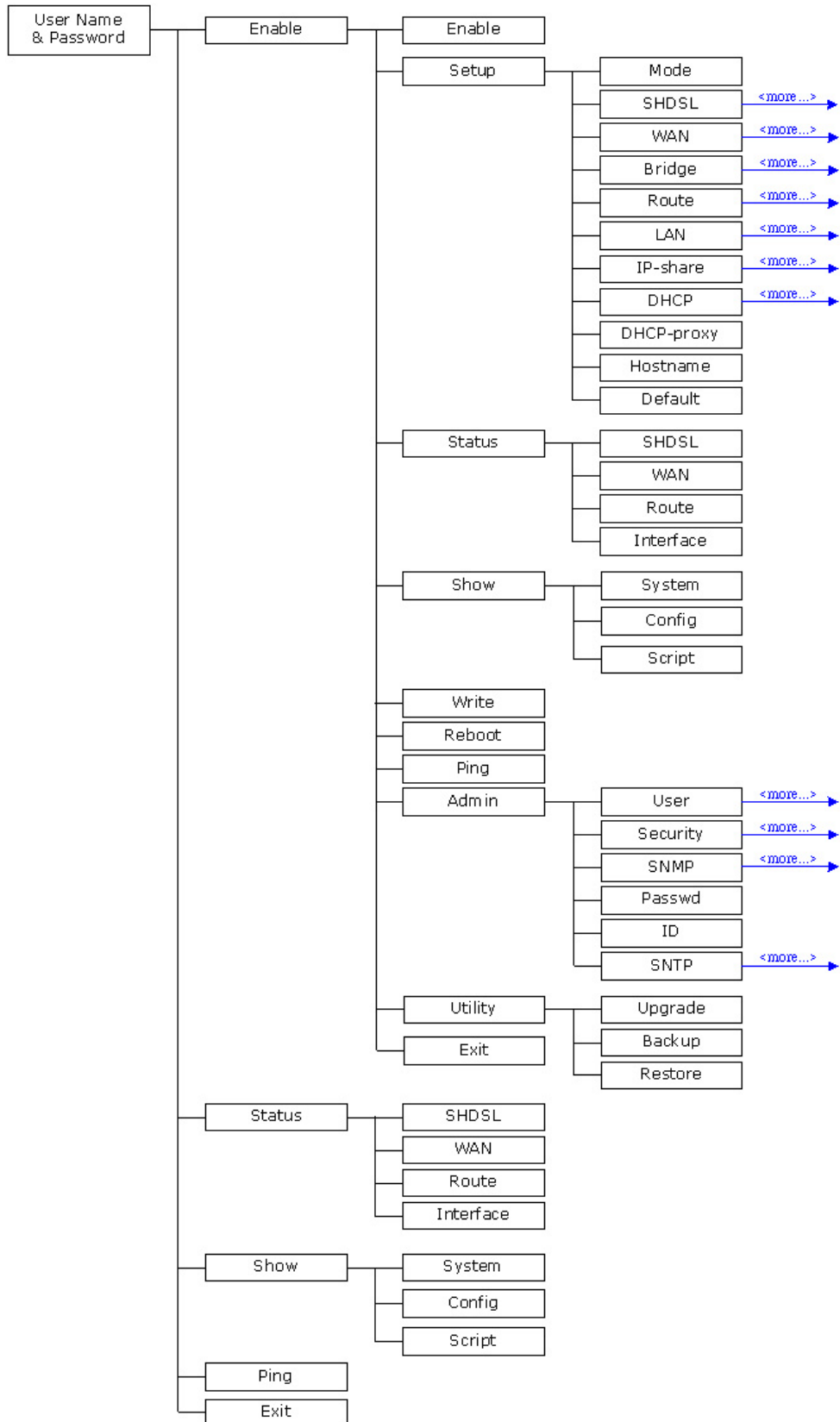

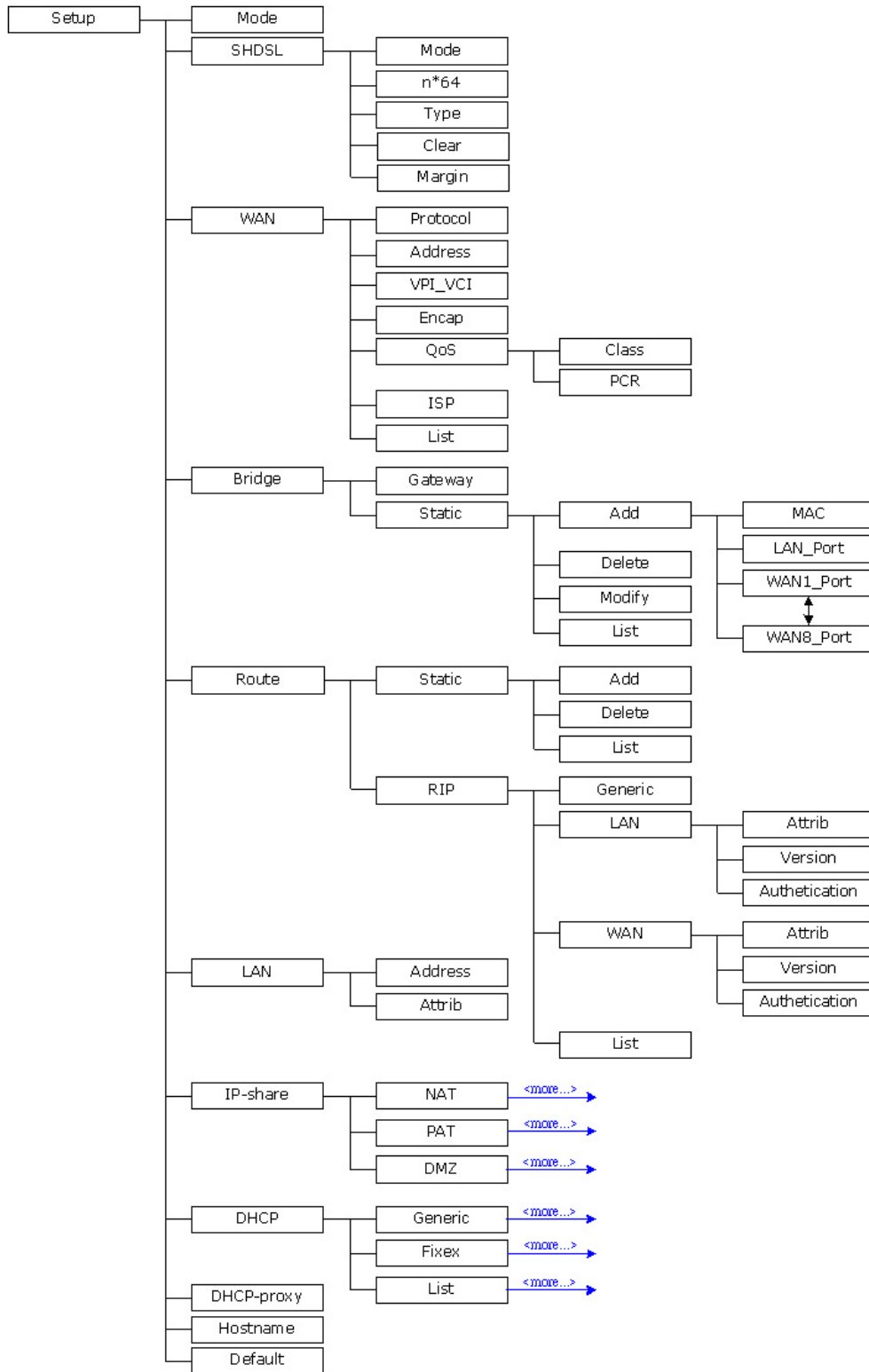

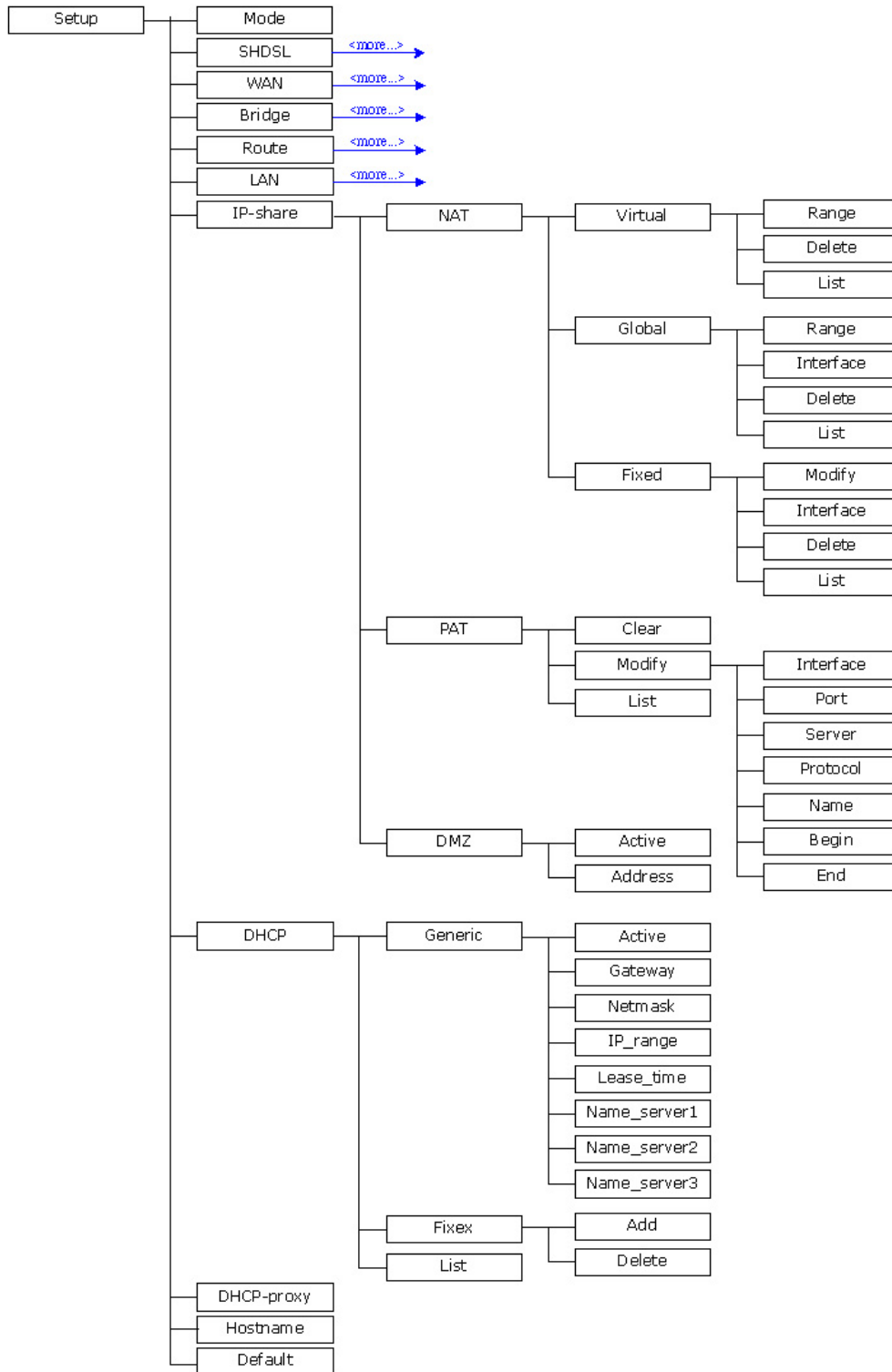

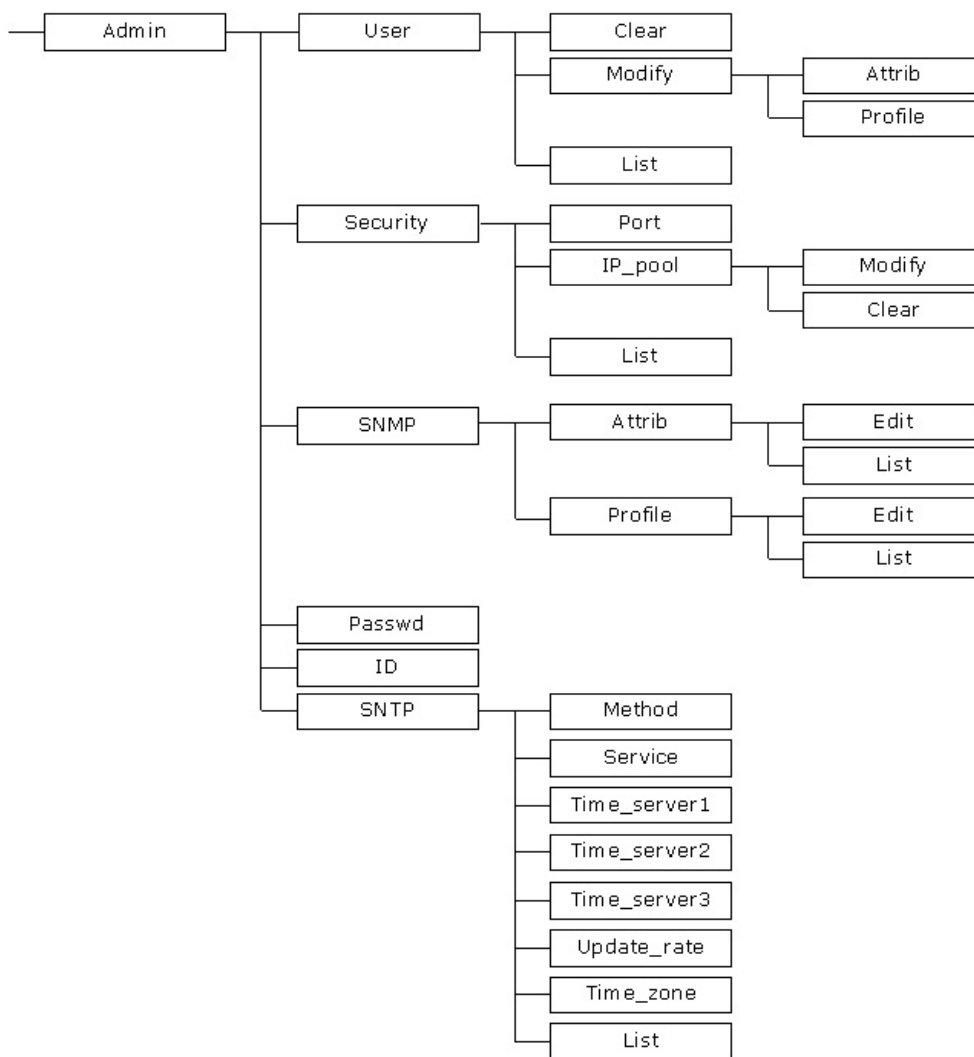

To start machine configuration, please move the cursor “>>” to **enable** and press enter key. GRT series will prompt for password for enable mode, insert the supervisor password. (Default supervisor password is **root.**) .

 Command: enable <CR>

Message: Please input the following information.

Supervisor password: ****

 In this sub menu, you can setup management parameters, upgrade machine firmware, backup and restore system configurations via **utility** menu.

 >> enable Modify command privilege
 setup Configure system
 status Show running system status
 show View system configuration
 write Update flash configuration

reboot	Reset and boot system
ping	Packet internet groper command
admin	Setup management features
utility	TFTP upgrade utility
exit	Quit system

3.4.4 Status

You can view running system status of SHDSL, WAN, route and interface via **status** command.

Move cursor ">>" to **status** and press enter.

>> shdsl	Show SHDSL status
wan	Show WAN interface status
route	Show routing table
interface	Show interface statistics status

3.4.5 Show

You can view the system information; configuration and configuration in command script by **show** command.

Move cursor ">>" to **show** and press enter.

>> system	Show general information
config	Show all configuration
script	Show all configuration in command script

3.4.6 Write

For any changes of configuration, you must write the new configuration to EPROM using **write** command and reboot GRT series to take affect.

Move cursor to ">>" to **write** and press enter.

Command: write <CR>

Message: Please input the following information.

Are you sure? (y/n): **y**

3.4.7 Reboot

To reboot GRT series, use **reboot** command. Move cursor to “ >> ” to **write** and press enter.

```
-----
Command: reboot <CR>
Message: Please input the following information.
```

```
Do you want to reboot? (y/n): y
-----
```

3.4.8 Ping

Ping command will be used to test the connection of router. Move cursor “ >> ” to **ping** and press enter.

```
-----
Command: ping <ip> [1~65534|-t] [1~1999]
Message: Please input the following information.
```

```
IP address <IP> : 10.0.0.1
Number of ping request packets to send (TAB select): 1~65534
Data size [1~1999]: 32
-----
```

3.5 Administration

You can modify the user profile, telnet access, SNMP (Simple Network Management Protocol), supervisor information and Sntp (Simple Network Time Protocol) in **machine enable mode**.

For configuration the parameters, move the cursor “ >> ” to **admin** and press enter.

```
-----
>> user          Manage user profile
   security      Setup system security
   snmp          Configure SNMP parameter
   passwd        Change supervisor password
   id            Change supervisor ID
   sntp          Configure time synchronization
-----
```

3.5.1 User Profile

You can use **user** command to clear, modify and list the user profile. You can setup at most five users to access GRT series via console port or telnet in user

profile table however users who have the supervisor password can change the configuration of GRT series. Move the cursor “>>” to **user** and press enter key.

>> clear	Clear user profile
modify	Modify the user profile
list	List the user profile

You can delete the user by number using **clear** command. If you do not make sure the number of user, you can use **list** command to check it. **Modify** command is to modify an old user information or add a new user to user profile.

3.5.2 Security

Security command can be configured ten legal IP address for telnet access and port number.

Move the cursor “>>” to **security** and press enter. The default legal address is 0.0.0.0. It means that there is no restriction of IP to access GRT series via telnet.

>> port	Configure telnet TCP port
ip_pool	Legal address IP address pool
list	Show security profile

3.5.3 SNMP

Simple Network Management Protocol (SNMP) is the protocol not only governing network management, but also the monitoring of network devices and their functions. GRT series can generate SNMP traps to indicate alarm conditions, and it relies on SNMP community strings to implement SNMP security. This router support MIB II.

Move the cursor “>>” to **snmp** and press enter.

>> community	Configure community parameter
trap	Configure trap host parameter

3.5.4 Supervisor Password and ID

The supervisor password and ID are the last door for security but the most important. Users who access GRT series via web browser, console port or telnet have to use the ID and password to configure GRT series. Suggest to change the ID and password.

3.5.5 SNTP

Time synchronization is an essential element for any business that relies on an IT system. The reason for this is that these systems all have clocks that are the source of time for files or operations they handle. Without time synchronization, time on these systems varies with each other or with the correct time and this can cause- virtual server schedule processes to fail and system log exposures with wrong data. There are two methods to synchronize time, synchronize with PC or SNTPv4. If you choose synchronize with PC, GRT series will synchronize with PC. If you choose SNTPv4, GRT series will use the protocol to synchronize with the time server.

Move the cursor “ >> “ to **sntp** and press enter.

```
>> method      Select time synchronization method
   service      Tigger SNTP v4.0 service
   time_server1 Configure time server 1
   time_server2 Configure time server 2
   time_server3 Configure time server 3
   updatarate   Configure update period
   time_zone    Configure GMT time zone offset
   list         Show SNTP configuration
```

3.6 Utility

There are three utility tools, upgrade, backup and restore, embedded in the firmware. You can update the new firmware via TFTP upgrade tools and backup the configuration via TFTP backup tool and restore the configuration via TFTP restore tool. For upgrade, TFTP server with the new firmware will be supported by supplier but for backup and restore, you must have your own TFTP server to backup and restore the file.

Move the cursor “ >> “ to **utility** and press enter.

```
>> upgrade     Upgrade main software
   backup      Backup system configuration
   Restore     Restore system configuration
```

3.7 Exit

If you want to exit the system without saving, use **exit** command to quit system.

3.8 Setup

All of the setup parameters are located in the subdirectories of setup. Move the cursor ">>" to **setup** and press enter.

>> mode	Switch system operation mode
shdsl	Configure SHDSL parameters
wan	Configure WAN interface profile
bridge	Configure transparent bridging
route	Configure routing parameters
lan	Configure LAN interface profile
ip_share	Configure NAT/PAT parameters
dhcp	Configure DHCP parameters
dns_proxy	Configure DNS proxy parameters
hostname	Configure local host name
default	Restore factory default setting

3.8.1 Mode

The product can act as routing mode or bridging mode. The default setting is routing mode. You can change the system operation mode by using mode command. Move the cursor ">>" to **mode** and press enter.

Command: setup mode <Route|Bridge>
 Message: Please input the following information.

System operation mode (TAB select) <Route>: **Route**

3.8.2 SHDSL

You can setup the SHDSL parameters by the command **shdsl**. Move the cursor ">>" to shdsl and press enter.

>> mode	Configure SHDSL mode
link (GRT-402 only)	Configure SHDSL link
n*64	Configure SHDSL data rate
type	Configure SHDSL annex type
clear	Clear current CRC error count
margin	Configure SHDSL SNR margin

There are two types of SHDSL mode, STU-R and STU-C. STU-R means the terminal of central office and STU-C customer premises equipment. GRT-402's link type will be 2-wire or 4-wire mode according to the product.

4-wire product can be worked under 2-wire mode.

You can setup the data rate by the multiple of 64Kbps- n is from 0 to 32. If you configure n is 0, the product will perform as adaptive mode.

There are two types of SHDSL Annex type, Annex-A and Annex-B.

Clear command can clear CRC error count.

Generally, you cannot need to change SNR margin, which range is from 0 to 10.

3.8.3 WAN

GRT series supports up to 8 PVC, private virtual circuit, and so you can setup eight WAN, WAN1 to WAN8. Move the cursor ">>" to **wan** and press enter. To setup WAN1, type **1**.

Command: setup wan <1~8>

Message: Please input the following information.

Interface number <1~8>: **1**

>> protocol	Link type protocol
address	IP address and subnet mask
vpi_vci	Configure VPI/VCI value
encap	Configure encapsulation type
qos	Configure VC QoS
isp	Configure account name, password and idle time
list	WAN interface configuration

There are four types of protocols, IPoA, EoA, PPPoA and PPPoE, which is supported by your ISP.

For PPPoA and PPPoE, you do not need to setup IP address and subnet mask.

There is an unique VPI and VCI value for Internet connection supported by ISP. The range of VPI is from 0 to 255 and VCI from 0 to 65535.

There are two types of encapsulation types, VC-Mux and LLC.

You can setup virtual circuit quality of service, VC QoS, using qos command.

There are two QoS class, UBR and CBR. The peak cell rate can be configured from 64kbps to 2400kbps.

ISP command can configure account name, password and idle time. Idle time are from 0 minute to 300 minutes.

You can review the WAN interface configuration via list command.

3.8.4 Bridge

You can setup the bridge parameters in bridge command. If the product is configured as a router, you do not want to setup the bridge parameters. Move the cursor “ >> ” to **bridge** and press enter.

>> gateway	Default gateway
static	Static bridging table

You can setup default gateway IP via gateway command.
You can setup 20 sets of static bridge in static command.

3.8.5 Route

You can setup the routing parameters in route command. If the product is configured as a bridge, you do not want to setup the route parameters. Move the cursor “ >> ” to **route** and press enter.

>> static	Configure static routing table
RIP	Configure RIP tool

You can setup 20 sets of static route in static command.

3.8.6 LAN

>> address	LAN IP address and subnet mask
attrib	NAT network type

3.8.7 IP share

>> nat	Configure network address translation
pat	Configure port address translation
dmz	Configure DMZ host function

For more NAT, PAT and DMZ information, review NAT/DMZ section.

3.8.8 DHCP

>> generic	Configure generic DHCP parameter
fixed	Configure fixed host IP address list
list	Show DHCP configuration

For more DHCP information, review DHCP server section.

3.8.9 DNS proxy

You can setup three DNS servers in the product. The number 2 and 3 DNS servers are option. Move cursor " >> " to dns_proxy and press enter.

Command: setup dns_proxy <IP> [IP] [IP]
 Message: Please input the following information.

DNS server 1 (ENTER for default) <168.95.1.1>: **10.0.10.1**
 DNS server 2: **10.10.10.1**
 DNS server 3:

3.8.10 Host name

Enter local host name via hostname command. Move cursor " >> " to **hostname** and press enter.

Command: setup hostname <name>
 Message: Please input the following information.

Local hostname (ENTER for default) <SOHO>: **test**

3.8.11 Default

If you want to restore factory default, first move the cursor " >> " to default and then press enter.

Command: setup default <name>
 Message: Please input the following information.

Are you sure? (Y/N): **y**

3.9 Connection Mode

GRT series supports two connection modes: bridging and routing. Currently, it comes pre-configured with routing mode. Note that, routing mode and bridging mode cannot be used simultaneously.

To let GRT series operate in bridging mode, type:

```
admin# setup mode bridge
```

To save changes enter:

```
admin# write
```

To enable your changes, reboot the system:

```
admin# reboot
```

To set GRT series operating in routing mode, enter:

```
admin# setup mode route
```

To save your changes enter:

```
admin# write
```

To enable your changes, reboot the system:

```
admin# reboot
```

3.10 Bridging Mode

Note: This section is for bridging mode operation only.

When GRT series operates in bridging mode, it behaves like a wire connecting a local PC directly to a service provider's network. Bridge data is encapsulated using the RFC1483 protocol to enable data transport. GRT series currently supports IEEE 802.1D transparent learning bridge.

3.10.1 Bridge management

You can manage GRT series using Telnet either from LAN interface or from Wide Area Network (WAN) interface. The following procedure shows how to

set up GRT series for bridging management with IP = 192.168.0.1, subnet mask = 255.255.255.0, and gateway IP = 192.168.0.254:

```
admin# setup lan 1 address 192.168.0.1 255.255.255.0
```

```
admin# setup bridge gateway 192.168.0.254
```

The IP address should be an IP address on the same network as that of the “far-end” station. The gateway IP address should be the IP address of the far-end station that is used to route the LAN packets.

To save your changes enter:

```
admin# write
```

To enable your changes, reboot the system:

```
admin# reboot
```

Note: The IP address that is assigned to GRT series, must be an IP address that is on the same network segment (subnet) that is being bridged. Assigning IP addresses in this fashion enables access via Telnet/web to GRT-101/GRT-401 for management functions. See section 3.15 Management Security for more information on security issues.

3.10.2 Static bridge table

This GRT series supports a transparent learning bridge, which will establish the bridge table automatically from the incoming data. Therefore, it is unnecessary to setup the static bridge table manually. In case you need to arrange the static bridge table, see the description below.

The following commands show how to setup the static bridge table by “add” command.

```
admin# setup bridge static add lan_port forward
```

```
admin# setup bridge static add wan1_port filter
```

```
admin# setup bridge static add mac 00:30:4f:00:00:01
```

Note: You must perform the above procedure in the sequence as shown, i.e., port attributes first and MAC finally.

To list the content of the table, use the “list” command:

```
admin# setup bridge static list
```

Static Bridging Parameters

1. MAC Address : 00:30:4f:00:00:01

<Interface Operation>

LAN 1(Forward)	WAN 1(Filter)	WAN 2(Filter)	WAN 3(Filter)
WAN 4(Filter)	WAN 5(Filter)	WAN 6(Filter)	WAN 7(Filter)
WAN 8(Filter)			

To modify the first entry in the table, use the “modify” command:

```
admin# setup bridge static modify 1 mac 00:30:4f:00:00:01  
admin# setup bridge static modify 1 lan_port filter  
admin# setup bridge static modify 1 wan1_port forward
```

To delete the first entry of the table, use the “delete” command:

```
admin# setup bridge static delete 1
```

To save your changes, enter:

```
admin# write
```

3.11 Routing Mode

Note: This section is for routing mode operation only.

Routing is often confused with bridging, which performs a similar function. The principal difference is that bridging occurs at a lower level (MAC layer) whereas routing occurs at a higher level, e.g., IP layer. And because routing occurs at a higher level, it can perform more complex analysis to determine the optimal path for the packet.

GRT series supports IP routing, which can be static and/or RIPv1/v2 updating. Also, several applications, such as NAT/PAT, DHCP server, and DNS proxy, etc., are included for LAN management and control.

3.11.1 LAN setting

To setup GRT series LAN interface with IP address of 192.168.0.1 and subnet mask of 255.255.255.0, use the following command:

```
admin# setup lan 1 address 192.168.0.1 255.255.255.0
```

To save your changes, enter:

```
admin# write
```

3.11.2 Static routing table

In order to pass data through a network and onto the Internet or WAN, you might need to add the IP addresses of gateways to the static routing table. Follow the instructions below to build a static routing table manually by adding or deleting entries in the table.

For example, to add a route to network address 140.182.1.0 with subnet mask of 255.255.255.0 via gateway at 140.182.2.254:

```
admin# setup route static add 140.182.1.0 255.255.255.0 140.182.2.254
```

To set a default route with gateway of 140.182.2.254, use the below command:

```
admin# setup route static add 0.0.0.0 0.0.0.0 140.182.2.254
```

In general, it is not recommended to add multiple entries with the format of default route (network address 0.0.0.0 with subnet mask of 0.0.0.0). If there are multiple entries with the format of default route in the static routing table, the system will automatically select only one entry to be the default route among these entries with resolvable gateway.

Note: For most WAN protocols, a valid default route with resolvable gateway on WAN side must be set to work properly. However, for PPP connections, GRT series will add default route to ISP gateway automatically, and hence it is unnecessary to add a default route manually.

To enable RIP updating with auto summary for routing table, type:

```
admin# setup route rip generic Enable Enable
```

For detailed configuration about RIPv1/RIPv2, please refer to the on-line help message by the following commands:

```
admin# setup route rip lan 1
```

```
admin# setup route rip wan 1
```

Note: Each WAN port could be configured independently for RIPv1/RIPv2 updating of routing table.

To show the configuration, use the list command:

```
admin# setup route rip list
```

To save your changes, enter:

```
admin# write
```

3.11.3 NAT/PAT

NAT can be used to share an Internet connection, to reduce the requirement for publicly assigned IP addresses, to expand an existing network without affecting existing IP based account schemes, and to hide an internal network schema from public networks.

It is often used in the situation where only one IP address could be assigned for the network, such as a PPP connection to an local ISP, e.g., when your local ISP uses protocols of "PPPoA" or "PPPoE" over the ATM VC, you get a dynamic public IP at the WAN port from your local ISP. All requests originating from the LAN (private network) have their source IP addresses replaced with the public IP address. Only one IP address is visible from the public network. To setup this GRT series working for the above example, enter:

```
admin# setup lan 1 attrib Virtual
```

Also, make sure to delete all entries in the NAT/PAT IP pools by the following commands:

```
admin# setup ip_share nat virtual delete <1~5>
```

```
admin# setup ip_share nat global delete <1~5>
```

```
admin# setup ip_share nat fixed delete <1~128>
```

```
admin# setup ip_share pat clear <1~10>
```

Note: The maximum number of hosts on the LAN (private network) is limited to be of 253 in dynamic NAT.

To save your changes, enter:

```
admin# write
```

In some cases, the number of externally visible IP addresses is greater than one and less than the host number being hidden behind GRT series. You could configure GRT series such that it acts as follows. Each time a request is made from a host on the LAN, which is included in virtual IP pool, e.g., pool 3: 192.168.0.2~192.168.0.25. GRT series chooses an external IP address already configured in the corresponding global IP pool 3 (e.g., 69.210.1.2~69.210.1.7, which is assigned from your local ISP) that is currently unused, and then performs the translation. This type of situation is only

possible when the number of hosts having concurrent requests to the external network is equal to or less than the number of external IP addresses on GRT series. To setup GRT series working for the above situation where WAN 1 is used to connect to the corresponding ISP, use the below commands:

```
admin# setup lan 1 attrib Virtual
```

```
admin# setup ip_share nat global interface 3 1
```

```
admin# setup ip_share nat global range 3 69.210.1.2 6
```

```
admin# setup ip_share nat virtual range 3 192.168.0.2 24
```

To show the configuration, use the list command:

```
admin# setup ip_share nat global list
```

```
admin# setup ip_share nat virtual list
```

Note: The IP translation only works between global and virtual IP pools with the same range number. Totally there are 5 NAT global and 5 NAT virtual IP pools for this purpose.

To save your changes, enter:

```
admin# write
```

In the above example, it might happen that packets from some hosts will be dropped when the number of hosts having concurrent requests to the external network is greater than the number of external IP addresses. If it is necessary to guarantee that some hosts (e.g., 192.168.0.31~192.168.0.33) can access Internet at any time, you can use the fixed IP address mapping pool with extra external IP addresses 69.210.1.8~69.210.1.10, also given from ISP via WAN 1:

```
admin# setup lan 1 attrib Virtual
```

```
admin# setup ip_share nat fixed interface 1 1
```

```
admin# setup ip_share nat fixed modify 1 192.168.0.31 69.210.1.8
```

```
admin# setup ip_share nat fixed interface 2 1
```

```
admin# setup ip_share nat fixed modify 2 192.168.0.32 69.210.1.9
```

```
admin# setup ip_share nat fixed interface 3 1
```

```
admin# setup ip_share nat fixed modify 3 192.168.0.33 69.210.1.10
```

To show the configuration, use the list command:

```
admin# setup ip_share nat fixed list
```

Note: The maximum number of entries in the NAT fixed IP address mapping pool is 128.

To save your changes, enter:

```
admin# write
```

Another function provided by this GRT series NAT/PAT is the virtual server mapping. Specific ports on the WAN interface (e.g., WAN 1) are re-mapped to services inside the LAN. As only 69.210.1.8 (e.g., assigned to WAN 1 from ISP) is visible to the Internet, but does not actually have any services (other than NAT off course) running on GRT series, it is said to be a virtual server. For example, requests with TCP made to 69.210.1.8:80 are remapped to the server 1 on 192.168.0.2:80, other requests with UDP made to 69.210.1.8:25 are remapped to server 2 on 192.168.0.3:25. To set GRT series for the above NAT function, use:

```
admin# setup lan 1 attrib Virtual
```

```
admin# setup ip_share pat modify 1 interface 1
```

```
admin# setup ip_share pat modify 1 port 80
```

```
admin# setup ip_share pat modify 1 server 192.168.0.2 80
```

```
admin# setup ip_share pat modify 1 protocol TCP
```

```
admin# setup ip_share pat modify 1 name httpd
```

```
admin# setup ip_share pat modify 2 interface 1
```

```
admin# setup ip_share pat modify 2 port 25
```

```
admin# setup ip_share pat modify 2 server 192.168.0.3 25
```

```
admin# setup ip_share pat modify 2 protocol UDP
```

```
admin# setup ip_share pat modify 2 name mail
```

To show the configuration, use the list command:

```
admin# setup ip_share pat list
```

Note: The maximum number of service mapping supported by GRT series is 10.

To save your changes, enter:

```
admin# write
```

3.11.4 DHCP server

The DHCP server application automatically assigns IP addresses to DHCP clients. Follow the steps below to enable the DHCP applications. The example sets a DHCP server, which could service 50 DHCP clients. The available IP addresses for DHCP clients are located from 192.168.0.2 to 192.168.0.51. In this example, the LAN environment is configured with gateway of 192.168.0.1 and subnet mask of 255.255.255.0. The IP address of 168.95.1.1 is set as a DNS server.

```
admin# setup dhcp generic active Enable
```

```
admin# setup dhcp generic ip_range 192.168.0.2 50
```

```
admin# setup dhcp generic gateway 192.168.0.1
```

```
admin# setup dhcp generic netmask 255.255.255.0
```

```
admin# setup dhcp generic name_server1 168.95.1.1
```

In most applications, the value of gateway IP address is the same as the LAN IP address of GRT series. The value of name server IP address should point towards a valid host that provides DNS lookup service. These parameters should be configured correctly, or computers on the LAN may not access Internet.

Note: If the DNS proxy has been configured properly, the "name_server1" field in the above DHCP configuration should be set with the LAN IP address of GRT series.

To save your changes, type:

```
admin# write
```

3.11.5 DNS proxy

DNS is the naming system for IP based networks and the naming service that is used to locate computers on the Internet. A DNS proxy receives DNS request from computers on the LAN, translates them into the encoding on DNS protocol, and forwards to the real DNS server. To enable the DNS proxy, please correctly set up the DNS proxy so that it can point towards real DNS servers on the Internet. The following example shows you how to setup the IP

addresses of real DNS servers:

```
admin# setup dns_proxy 168.95.1.1 168.95.192.1 140.92.61.55
```

Note: For PPP connections, GRT series will get DNS server IPs from ISP and assign them into DNS proxy automatically if they have been pre-configured by the local ISP.

The maximum number of DNS servers is limited to 3. To save your changes, enter:

```
admin# write
```

3.12 WAN and ATM Virtual Connection

GRT series has two types of WAN ports: physical WAN port (SHDSL) and logical WAN ports (WAN 1~8). The physical WAN port connects GRT series to the WAN. The logical WAN port or ports allow you to create virtual WAN connections for plural destinations. When configuring the physical WAN port, you can change the SHDSL physical layer protocol setting. To configure logical WAN ports, you must provision ATM virtual connections for each logical connection. The instructions for each are shown below.

3.12.1 SHDSL operation

There are two SHDSL operation modes: STU-R and STU-C. GRT series supports both operation modes and automatically trains up to the ideal line speed. This enables the maximum operative rate as determined by the central office SHDSL equipment, or you could configure the connection rate directly.

Note: Optimal line rates are dependent upon the central office equipment base and optimal line conditions.

Follow the procedure below to change SHDSL physical layer setting.

To set the SHDSL operation mode to STU-R, enter:

```
admin# setup shdsl mode STU-R
```

To set the SHDSL operation mode to STU-C, enter:

```
admin# setup shdsl mode STU-C
```

To set link type to 4 wire, enter:

Only GRT-402 support 4 wire phone line to connect, it also allow to assign link type by actually connection type.

```
admin# setup shdsl link 4-Wire
```

To set link type to 2 wire, enter:

```
admin# setup shdsl link 2-Wire
```

Also, GRT series allows you to assign the connection rate directly by setting the *N* parameter of “n*64” command:

```
admin# setup shdsl n*64 <0~36>
```

where “0” indicates that the adaptive mode will be used to automatically train up to the ideal line speed. The other valid value of *N* parameter ranges between 3 and 36. Do not set the *N* value to 1 or 2. For example, to configure the SHDSL physical layer data rate to 256kbps, enter:

```
admin# setup shdsl n*64 4
```

For different region, you might need to set up the SHDSL type to be “Annex_A” or “Annex_B” by the following command:

```
admin# setup shdsl type Annex_B
```

Note that, to let your setting take effect, you have to save your changes and reboot the system by enter:

```
admin# write
```

3.12.2 ATM virtual connection

There are two types of ATM connections: (1) virtual paths, identified by virtual path identifiers (VPI); and (2) virtual circuit, identified by the combination of a VPI and a virtual circuit identifier (VCI). Also, there are two encapsulation methods for carrying bridged and routed PDUs in the payload field of ATM adaptation layer (AAL) type 5, which are defined in RFC 1483, multi-protocol encapsulation over AAL 5. The LLC encapsulation method multiplexes multiple protocols on a single ATM virtual circuit. Each protocol is identified in the 802.2

LLC header of the packet. The VC based multiplexing method carries each protocol on a separate ATM virtual circuit. This method is sometimes used in private networks, in which PVC creation is very economical.

Note: Each VC is expressed as WAN x, where x is a number between 1 and 8. GRT series comes pre-configured with one ATM VC (WAN 1 with VPI/VCI = 0/32) already established. The WAN 1 port is ready to send and receive network traffic via IPoA protocol with LLC encapsulation. You may need to modify the pre-configured ATM VC when communicating across your local ISP network.

For bridging mode operation, you should select Ethernet over ATM (RFC 1483 bridged Ethernet) as the ATM protocol. For routing mode operation, GRT series supports Ethernet over ATM (RFC 1483 bridged Ethernet), IP over ATM (RFC 1483 routed IP/RFC 1577), PPP over ATM (RFC 2364), and PPP over Ethernet (RFC 2516). The following example enables the ATM VC WAN 3 with protocol of Ethernet over ATM:

```
admin# setup wan 3 protocol Ethernet
```

where the selectable parameters corresponding to the above ATM protocols are "Ethernet", "IPoA", "PPPoA", and "PPPoE". To disable the pre-configured ATM VC WAN 1, enter:

```
admin# setup wan 1 protocol Disable
```

The valid ranges for the VPI is from 0 to 255. For the VCI, it is between 0 and 65535.

The following example set the VPI/VCI = 0/135 for ATM VC WAN 3

```
admin# setup wan 3 vpi_vci 0 135
```

To change the encapsulation from default LLC to VC-Mux for ATM VC WAN 3

```
admin# setup wan 3 encap VC-Mux
```

To review the new configuration you have changed for WAN 3, type:

```
admin# setup wan 3 list
```

```
WAN Interface Parameters
```

Int.	Link	IP Address/	Netmask	VPI/	VCI	Encap.	QoS	PCR
WAN 1	Disable							
WAN 2	Disable							
WAN 3	Ethernet	192.168.3.1/	255.255.255.0	0/	135	VC-Mux	UBR	2400
WAN 4	Disable							
WAN 5	Disable							

WAN 6 Disable

WAN 7 Disable

WAN 8 Disable

To save the new WAN port configuration, enter:

admin# **write**

3.12.3 ATM traffic shaping

The objectives of ATM traffic management are to deliver quality-of-service (QoS) guarantees for the multimedia applications and provide overall optimization of network resources. Currently, GRT series supports two kinds of ATM QoS service: constant bit rate (CBR) and unspecified bit rate (UBR). The CBR connection involves a static amount of bandwidth allocated for those applications of video, voice, and circuit emulation. The bandwidth is characterized by the peak cell rate (PCR) in the configuration. The UBR connection allows you to define the PCR too. However, it has the lowest priority and is with no QoS guarantees. The range of the PCR is from 64 to 2400Kbps.

To set the class of the ATM traffic shaping for WAN 3 to CBR with PCR of 512Kbps, enter:

admin# **setup wan 3 qos class CBR**

admin# **setup wan 3 qos pcr 512**

To review the new configuration you have changed for WAN 3, type:

admin# **setup wan 3 list**

WAN Interface Parameters

Int.	Link	IP Address/	Netmask VPI/	VCI Encap.	QoS PCR
-----	-----	-----	-----	-----	-----
WAN 1	Disable				
WAN 2	Disable				
WAN 3	Ethernet	192.168.3.1/	255.255.255.0	0/ 135	VC-Mux CBR 512
WAN 4	Disable				
WAN 5	Disable				
WAN 6	Disable				
WAN 7	Disable				

WAN 8 Disable

To save the new WAN port configuration, enter:

admin# **write**

3.12.4 WAN IP address

Note: This sub-section is for routing mode operation with protocol of "Ethernet" and/or "IPoA" only. For PPP connections, it is unnecessary to set the WAN port IP address and subnet mask.

To set the WAN 3 with IP address of 192.168.3.3 and subnet mask of 255.255.255.0, follow the following example:

admin# **setup wan 3 address 192.168.3.3 255.255.255.0**

To review the new configuration you have configured, type:

admin# **setup wan 3 list**

WAN Interface Parameters

Int.	Link	IP Address/	Netmask VPI/	VCI Encap.	QoS PCR
-----	-----	-----	-----	-----	-----
WAN 1	Disable				
WAN 2	Disable				
WAN 3	Ethernet	192.168.3.3/	255.255.255.0	0/ 135	VC-Mux CBR 512
WAN 4	Disable				
WAN 5	Disable				
WAN 6	Disable				
WAN 7	Disable				
WAN 8	Disable				

To save the new WAN port configuration, enter:

admin# **write**

3.12.5 ISP profile for PPP

Note: This sub-section is for routing mode operation only.

If your local ISP uses protocols of “PPPoA” or “PPPoE” over the ATM VC, you may need to setup the username and password information provided from your local ISP. The maximum length of username and password for ISP setting is limited to 51. The following command configures the ISP profile for WAN 3 with username “pppoa3@isp.com”, password “Fuyg47ds”, and idle timeout of 10 minutes:

```
admin# setup wan 3 isp pppoa3@isp.com Fuyg47ds 10
```

To review the new configuration you have configured, type:

```
admin# setup wan 3 list
```

```
Int.      ISP account username      Idle time
-----
WAN 1
WAN 2
WAN 3          pppoa3@isp.com          10
WAN 4
WAN 5
WAN 6
WAN 7
WAN 8
```

Note: The ISP account information would not be shown if the corresponding WAN port is disabled. The account information is provided from your local ISP. Please ask your local ISP if you do not know the username and password.

The “PPPoA” and “PPPoE” protocols are designed based on the concept of “dial-on-demand”. Each time a request is made from a host on the LAN, GRT series checks the link status of the WAN ports and transfers the packets if the link status is active. When the link status is not active, it performs login procedure with the account information of ISP profiles and then transfers the packets if login successfully. Once the link has been established successfully, GRT series continuously monitors the traffic over WAN links. The “PPPoA” or “PPPoE” section will be cut off if there are no packets over the links during the period of idle timeout. The valid value for idle timeout is from 0 to 300 minutes. The idle timeout of “0” means that the session connects always even there is no traffic over the WAN link. To save the new WAN port configuration, enter:

```
admin# write
```

Note: Currently, the session timeout is set to be 10 minutes. Also, WAN 1 has the highest priority to dial if multiple WAN ports are enabled with PPPoA/PPPoE protocols while WAN 8 has the lowest one. In most applications,

PPPoA/PPPoE protocols must work with NAT/PAT. Please refer to section 3.11.3 NAT/PAT for details.

3.13 System Status and Performance

Use the “status” command to display GRT series activities. To see a list of applications and interfaces that provide status, enter:

```
admin# status ?
  shdsl <CR>          Show SHDSL status
  wan <CR>            Show WAN interface status
  route <CR>         Show routing table
```

To display specific information, for example, for the SHDSL interface status and performance, enter:

```
admin# status shdsl
```

```
<SHDSL Status>
```

```
SHDSL mode           :SHDSL CPE Side
Bitrate              :512kbps
Tx Power             :13.5dBm
Current SNR Margin   :10.8dB
Attenuation          :35.8dB
CRC Error Count      :0
```

```
SHDSL Remote Side Status
```

```
Current SNR margin   :10dB
Attenuation          :35dB
CRC Error Count      :0
```

These statistics are:

- CRC error count — The cyclic redundancy check error count.
- Attenuation —The difference in decibels (dB) between the power level received at the near end versus the power level transmitted from the far end.
- Signal-to-Noise (SNR) Margin — The SNR margin represents the amount of increased received signal (in decibels) relative to the noise power level that the unit is designed to tolerate without disconnecting from the network.

To display status of WAN ports, enter:

```
admin# status wan
```

```
WAN   IP address   /   NetMask   VPI/ VCI   Enc   Protocol   Active
```

```
-----
WAN1  192.168.  1.  1/255.255.255.  0  0/  32  LLC      IPoA    Yes
```

To list active route status currently, type:

```
admin# status route
```

```
Flag  Destination /      Netmask /  Gateway      Interface  Portname
-----
S      0.0.0.0/           0.0.0.0/  200.0.8.254  200.0.8.1  WAN1
C      200.0.8.0/ 255.255.255.0/  directly      200.0.8.1  WAN1
C      192.168.0.0/ 255.255.255.0/  directly      192.168.0.218  LAN
C      127.0.0.1/255.255.255.255/  directly      127.0.0.1 Loopback
```

3.14 User Profile

GRT series comes pre-configured with user profile 1 already established, that is, user “admin” with password of “admin” and menu driven user interface. The maximum number of user profiles is limited to 5. You can add, delete, modify, or list the user profiles with the commands in the following examples.

To change anyone of the user name and password, you must provide both items together. For example, to change the password only to “76gu94t” for user profile 1 (default user name “admin”), enter:

```
admin# admin user modify 1 profile admin 76gu94t
```

For user profile 1 with password “76gu94t”, to change the username to “titan” type:

```
admin# admin user modify 1 profile titan 76gu94t
```

Certainly, you can change both user name and password in one command line. The maximum length of user name and password is limited to 19.

To set the user interface for an existing user profile, e.g., user profile 1, use “modify” and “attrib” commands:

```
admin# admin user modify 1 attrib command
```

The following commands add a new user profile 2 “test” with password “83fdi7s”, and set the user interface to menu mode:

```
admin# admin user modify 2 attrib menu
```

```
admin# admin user modify 2 profile test 83fdi7s
```

Note: You must perform the above procedure in the sequence as shown.

To show all user profiles with attributes, type:

```
admin# admin user list
```

```
Legal access user profile
```

No	User Name	UI Mode
1	titan	Command
2	test	Menu
3	(Empty)	
4	(Empty)	
5	(Empty)	

To delete user profile 2, enter:

```
admin# admin user clear 2
```

To save your changes, enter:

```
admin# write
```

3.15 Management Security

Since you can manage GRT series using Telnet and web browser over the network either from LAN interface or from WAN interface, the management security is important that it prevents invalid access to GRT series from Internet. There are extra two levels of protection for GRT series Telnet and web servers except login password control:

3.15.1 Telnet port number

You can specify the TCP port number of the Telnet server other than the default TCP port number 23 so that Telnet access to default port number cannot reach GRT series. The example below shows you how to setup the Telnet TCP port number from default 23 to 47:

```
admin# admin security port 47
```

The valid range of the Telnet port number is between 1 and 65534. To show which TCP port number is set to allow access to GRT series, type

```
admin# admin security list
```

Configuration generic parameter

Telnet listening TCP port : 47

To save your changes, enter:

admin# **write**

3.15.2 Legal client IP

You could assign the legal client IP addresses such that only Telnet clients and web browsers at the legal client IP addresses can access GRT series. The following example specifies a legal IP address 192.168.0.6 in the pool.

admin# **admin security ip_pool modify 1 192.168.0.6**

The maximum number in the legal IP pool is limited to 10. To show how many legal client IP addresses are configured to allow access to GRT series, enter:

admin# **admin security list**

Legal client IP address

No	Legal IP Address
1	192.168.0.6
2	(Empty)
3	(Empty)
4	(Empty)
5	(Empty)
6	(Empty)
7	(Empty)
8	(Empty)
9	(Empty)
10	(Empty)

An empty table means there is not any constraint on the Telnet client and web browser IP addresses. The example below deletes the first IP entry from the legal IP address pool.

admin# **admin security ip_pool clear 1**

To save your changes, enter:

admin# **write**

Note: GRT series comes pre-configured without any constraint on the legal access IP addresses of Telnet clients and web browsers for convenience. However, it is very important to setup management security to prevent invalid access to GRT series from Internet.

3.16 SNMP Support

In addition to managing GRT series by means of the command-line applications and web browsers, you can manage the unit by using a simple network management protocol (SNMP) management station. GRT series can generate SNMP traps to indicate alarm conditions, and it relies on SNMP community strings to implement SNMP security. Currently, SNMP (RFC 1157) and SNMPv2c (RFC 1901) agents are implemented. Also, the management information bases (MIBs) supported by GRT series include MIB II right now.

3.16.1 SNMP community

The below example adds GRT series into a SNMP community "private", with read/write access right for SNMP managers in the same community.

```
admin# admin snmp community 1 edit enable private read_write
```

To show the setting of SNMP communities with access right, type:

```
admin# admin snmp community 1 list
```

```
SNMP Community Pool
```

No	Community	Access Right
1	private	Read_Write
2	(Empty)	
3	(Empty)	
4	(Empty)	
5	(Empty)	

To disable the SNMP community 1, enter the following command:

```
admin# admin snmp community 1 edit disable private read_write
```

To save your changes, enter:

```
admin# write
```

3.16.2 SNMP trap

GRT series can generate alarm conditions to SNMP manager via SNMP traps. The following example configures trap 1 with SNMPv2c encapsulation. The SNMP manager is located at 192.168.0.254 with community "private".

```
admin# admin snmp trap 1 edit 2 192.168.0.254 private
```

To show the setting of SNMP communities with access right, type:

```
admin# admin snmp trap 1 list
```

SNMP Trap Host Pool

No	Trap	IP Address	Version
1	private	192.168.0.254	2
2	(Empty)		
3	(Empty)		
4	(Empty)		
5	(Empty)		

To disable the SNMP trap 1, enter the following command:

```
admin# admin snmp trap 1 edit disable 192.168.0.254 private
```

To save your changes, enter:

```
admin# write
```

3.17 Backup and Restore Configuration

Remember to backup a copy of your configuration file after you have completed configuration of GRT series so you can easily recover it when necessary.

3.17.1 Backup configuration

Use "show script" command to dump the system current configuration in script commands. The following is an example.

```
admin# show script
```

Showing System Configuration...

```
setup mode Route
setup shdsl mode STU-R
setup shdsl n*64 0
setup shdsl type Annex_A
setup shdsl margin 0
setup wan 1 protocol IPoA
setup wan 1 address 192.168.1.1 255.255.255.0
setup wan 1 vpi_vci 0 32
setup wan 1 encap LLC
setup wan 1 qos class UBR
setup wan 1 qos pcr 2400
setup wan 1 isp test test 10
...
admin snmp trap 3 edit Disable 192.168.0.254 private
admin snmp trap 4 edit Disable 192.168.0.254 private
admin snmp trap 5 edit Disable 192.168.0.254 private
admin#
```

After dumping the configuration, use the copy and paste function provided by your terminal access program or Telnet program to save it to a text file. Don't miss any script command line, or you would loss part of the configuration.

Note: With "show script" command, the password is printed with "*" instead of the real password characters for security. Therefore, the backup configuration does not contain the password information. Remember to recover correct password information manually after the backup procedure by a text editor. There is no command that could show the password information. You should save your password in a safe place for any eventuality.

3.17.2 Restore configuration

Before you restore the old configuration back to GRT series, make sure to clear the whole setting back to the factory defaults first with the following command:

```
admin# setup default
Are you sure? (y/n): y
Set OK!
admin#
```

To restore the configuration, copy the content of the whole configuration file, which was saved according to section 3.17.1 Backup configuration, and paste them into the console CLI via your Telnet program or terminal access program.

Watch the system messages to ensure every command was accepted by the system successfully.

Note: The Telnet program is recommended during backup process. If only the serial port could be used, carefully add some delay by adjust the line and/or character delay for your terminal access program so that all command could be accepted by the system without error. Also, the configuration file backup with "show script" command has the password printed with "*" instead of the real password characters for security. Therefore, remember to recover correct password information manually before the restore procedure.

To save your restored configuration and let it take effect, enter:

```
admin# write
```

and reboot the system.

3.18 Software Upgrade

You check the software version of GRT series by the command:

```
admin# show system
```

General system information

```
Model           :08A2
Software Version :101029E4
CPU             :MPC850SR(rev.B)
RAM            :4MB
Flash          :2MB
Chipset        :AD20msp930
Firmware Version :3130BE6B
Hostname       :SOHO
System Time    :152DAY/18HR/12MIN
```

If GRT series is out of date, get the latest version from your service provider by the trivial file transfer protocol (TFTP). The TFTP allows you to transfer new software images to upgrade GRT series. Refer to section 3.17.1 Backup configuration to backup a copy of your configuration file before upgrading it so you can easily recover the configuration when necessary.

The following example shows you how to get a kernel software image from a TFTP server 192.168.0.200, where the image file name is "kernel.bin":

```
admin# upgrade kernel 192.168.0.200 kernel.bin
```

```
TFTP server IP address: 192.168.0.200
```

```
Upgrade filename: kernel.bin
```

```
Connecting...
```

Download

Byte Transferred : 624641 bytes

Complete

Transfer Complete, Replace Now? (y/n): **y**

Writing flash..... OK!

Do you want to reboot? (y/n): **y**

Be sure to write the new image to NVRAM and immediately reboot the device to activate it. When you log back onto GRT series after the reboot, then you can use the “show system” command to verify the version of the new firmware that is active, and restore your configuration.

Note: All configurations will be cleared during the upgrading procedure. Make sure that you have a backup configuration file before you start the upgrading procedure. See section 3.17.1 Backup configuration for details.

Free Manuals Download Website

<http://myh66.com>

<http://usermanuals.us>

<http://www.somanuals.com>

<http://www.4manuals.cc>

<http://www.manual-lib.com>

<http://www.404manual.com>

<http://www.luxmanual.com>

<http://aubethermostatmanual.com>

Golf course search by state

<http://golfingnear.com>

Email search by domain

<http://emailbydomain.com>

Auto manuals search

<http://auto.somanuals.com>

TV manuals search

<http://tv.somanuals.com>