



54M Wireless VPN Firewall Router

VRT-401G

User's Manual

Copyright

Copyright (C) 2005 PLANET Technology Corp. All rights reserved.

The products and programs described in this User's Manual are licensed products of PLANET Technology, This User's Manual contains proprietary information protected by copyright, and this User's Manual and all accompanying hardware, software, and documentation are copyrighted.

No part of this User's Manual may be copied, photocopied, reproduced, translated, or reduced to any electronic medium or machine-readable form by any means by electronic or mechanical. Including photocopying, recording, or information storage and retrieval systems, for any purpose other than the purchaser's personal use, and without the prior express written permission of PLANET Technology.

Disclaimer

PLANET Technology does not warrant that the hardware will work properly in all environments and applications, and makes no warranty and representation, either implied or expressed, with respect to the quality, performance, merchantability, or fitness for a particular purpose.

PLANET has made every effort to ensure that this User's Manual is accurate; PLANET disclaims liability for any inaccuracies or omissions that may have occurred.

Information in this User's Manual is subject to change without notice and does not represent a commitment on the part of PLANET. PLANET assumes no responsibility for any inaccuracies that may be contained in this User's Manual. PLANET makes no commitment to update or keep current the information in this User's Manual, and reserves the right to make improvements to this User's Manual and/or to the products described in this User's Manual, at any time without notice.

If you find information in this manual that is incorrect, misleading, or incomplete, we would appreciate your comments and suggestions.

CE mark Warning

This is a class B device, in a domestic environment, this product may cause radio interference, in which case the user may be required to take adequate measures.

WEEE Regulation



To avoid the potential effects on the environment and human health as a result of the presence of hazardous substances in electrical and electronic equipment, end users of electrical and electronic equipment should understand the meaning of the crossed-out wheeled bin symbol. Do not dispose of WEEE as unsorted municipal waste and have to collect such WEEE separately.

Trademarks

The PLANET logo is a trademark of PLANET Technology.

This documentation may refer to numerous hardware and software products by their trade names. In most, if not all cases, these designations are claimed as trademarks or registered trademarks by their respective companies.

Revision

User's Manual for PLANET 54M Wireless VPN Firewall Router

Model: VRT-401G

Rev: 1.0 (Dec, 2005)

Part No. 2081-B42060-000

Table of Content

Introduction.....	5
Features.....	5
Minimum Requirements	5
Package Content.....	5
Get to know the Wireless VPN Firewall Router	6
Back Panel.....	6
Front Panel	6
Setup Diagram	7
Getting started	7
Chapter 1	16
Quick Setup.....	16
Step 1) Time Zone	16
Step 2) Broadband Type.....	17
1.1 Cable Modem	18
1.2 Fixed-IP xDSL.....	18
1.3 PPPoE	19
1.4 PPTP	21
1.5 L2TP	23
1.6 Telstra Big Pond	25
Chapter 2	27
General Settings	27
2.1 System	28
2.1.1 Time Zone	28
2.1.2 Password Settings.....	29
2.1.3 Remote Management.....	30
2.2 WAN	31
2.2.1 Dynamic IP	32
2.2.2 Static IP Address	32
2.2.3 PPPoE (PPP over Ethernet)	32
2.2.4 PPTP	32
2.2.5 L2TP	33
2.2.6 Telstra Big Pond	33
2.2.7 DNS	33
2.2.8 DDNS.....	34
2.3 LAN	34
2.4 Wireless	36
2.4.1 Basic Settings	36
2.4.2 Advanced Settings.....	41
2.4.3 Security.....	42
2.4.3.1 WEP only	42
2.4.3.2 802.1x only	44
2.4.3.3 802.1x WEP Static key	44
2.4.3.4 WPA Pre-shared key	45
2.4.3.5 WPA Radius.....	46
2.4.4 Access Control.....	47

2.5 QoS	48
2.6 NAT	50
2.6.1 Port Forwarding	52
2.6.2 Virtual Server	52
2.6.3 Special Applications	55
2.6.4 UPnP Settings	56
2.6.5 ALG Settings	57
2.6.6 Static Routing.....	58
2.7 Firewall	60
2.7.1 Access Control.....	60
2.7.2 URL Blocking	63
2.7.3 DoS (Denial of Service)	64
2.7.4 DMZ	66
2.8 VPN	67
2.8.1 IPsec Server	67
2.8.2 L2TP Server	71
2.8.3 PPTP Server	72
Chapter 3	74
Status	74
3.1 Status and Information	74
3.2 Internet Connection	75
3.3 Device Status	76
3.4 System Log	76
3.5 Security Log	77
3.6 Active DHCP Client	78
3.7 Statistics	78
Chapter 4	80
Tool	80
4.1 Configuration Tools	80
4.2 Firmware Upgrade	81
4.3 Reset	82
Appendix A	83
Glossary	84

Introduction

Congratulations on purchasing Planet 54M Wireless VPN Firewall Router – VRT-401G. It is a cost-effective VPN Firewall Router that enables multiple users to access the resource through VPN tunnel. Simply configure your Internet connection settings in the 54M Wireless VPN Firewall Router and plug your PC to the LAN port and you're ready to share files and access the Internet. The VRT-401G is embedded with an IEEE 802.11g/b access point that allows you to build up a wireless LAN. The 54M Wireless VPN Firewall Router provides a total solution for the Small and Medium-sized Business (SMB) and the Small Office/Home Office (SOHO) markets, giving you an instant network today, and the flexibility to handle tomorrow's expansion and speed.

Features

- Compliant with 802.11g / 802.11b standard
- AP / AP Client / WDS / Bridge modes supported
- Supports 64/128-bit WEP, WPA, WPA2 Encryption to protect the wireless data transmissions
- IPSec VPN gateway (ESP, IKE)
- Provides 3DES / AES encryption and MD5 and SHA1 authentication algorithms
- PPTP and L2TP server / client support
- VPN Pass Through (IPSec/PPTP/L2TP)
- QoS support
- DHCP/PPPOE/PPTP/L2TP/Fixed IP/Wireless allocation
- MAC/IP filter access control, URL blocking
- SPI firewall + DoS prevention protection
- Supports Virtual and DMZ function
- Supports UPnP function
- Supports DDNS function
- Supports DHCP Server for easy setup
- Easy to use Web-based GUI for configuration and remote management purposes
- Status monitoring includes: Active DHCP Client, Security Log and Device/Connection Status
- Equipped with four LAN ports (10/100M) and one WAN port (10/100M), Auto-MDI/MDI-X supported

Minimum Requirements

- One External xDSL (ADSL) or Cable modem with an Ethernet port (RJ-45)
- Network Interface Card (NIC) for each Personal Computer (PC)
- PCs with a Web-Browser (Internet Explorer 4.0 or higher, or Netscape Navigator 4.7 or higher)

Package Content

- 54M Wireless VPN Firewall Router unit x 1
- Quick Installation Guide x 1
- User Manual CD x 1
- Power Adapter x 1
- Accessories

Get to know the Wireless VPN Firewall Router

Back Panel

The diagram (fig1.0) below shows the VRT-401G's back panel. The router's back panel is divided into three sections, **LAN**, **WAN** and **Reset**:

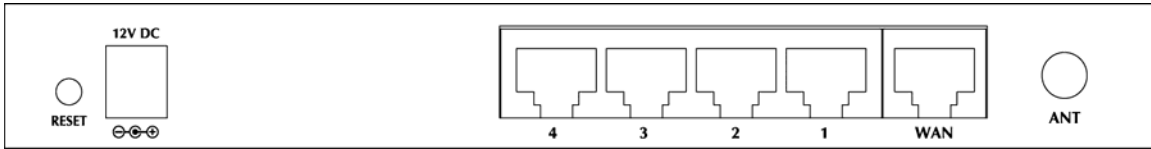

Figure 1.0

1) Local Area Network (LAN)

The VRT-401G's 4 LAN ports are where you connect your LAN's PCs, printer servers, hubs and switches etc.

2) Wide Area Network (WAN)

The WAN port is the segment connected to your xDSL or Cable modem and is linked to the Internet.

3) Reset

The Reset button allows you to do one of two things.

- 1) If problems occur with your router, press the router's reset button with a pencil tip (for less than 4 seconds) and the router will re-boot itself, keeping your original configurations.
- 2) If problems persist or you experience extreme problems or you forgot your password, press the reset button for longer than 4 seconds and the router will reset itself to the factory default settings (**warning**: your original configurations will be replaced with the factory default settings)

Front Panel

On the router's front panel there are LED lights that inform you of the router's current status. Below is an explanation of each LED and its description.



Figure 1.1

LED	Light Status	Description
PWR	ON	Router's power supply is on
WAN 10/100M	ON	WAN port 100Mbps is connected
	OFF	WAN port 10Mbps is connected
WAN LNK/ACT	ON	WAN is connected
	OFF	No WAN connection
	Flashing	WAN port has Activity (ACT), data being sent

LAN 10/100M (Port 1-4)	ON OFF	LAN port 100Mbps is connected LAN port 10Mbps is connected
LAN LNK/ACT (Port 1-4)	ON OFF Flashing	LAN is connected No LAN connection LAN port has Activity (ACT), data being sent
WLAN	ON OFF Flashing	Wireless LAN has been activated Wireless LAN is disabled Wireless LAN has Activity (ACT) data being sent

Setup Diagram

Figure 1.2 below shows a typical setup for a Local Area Network (LAN).

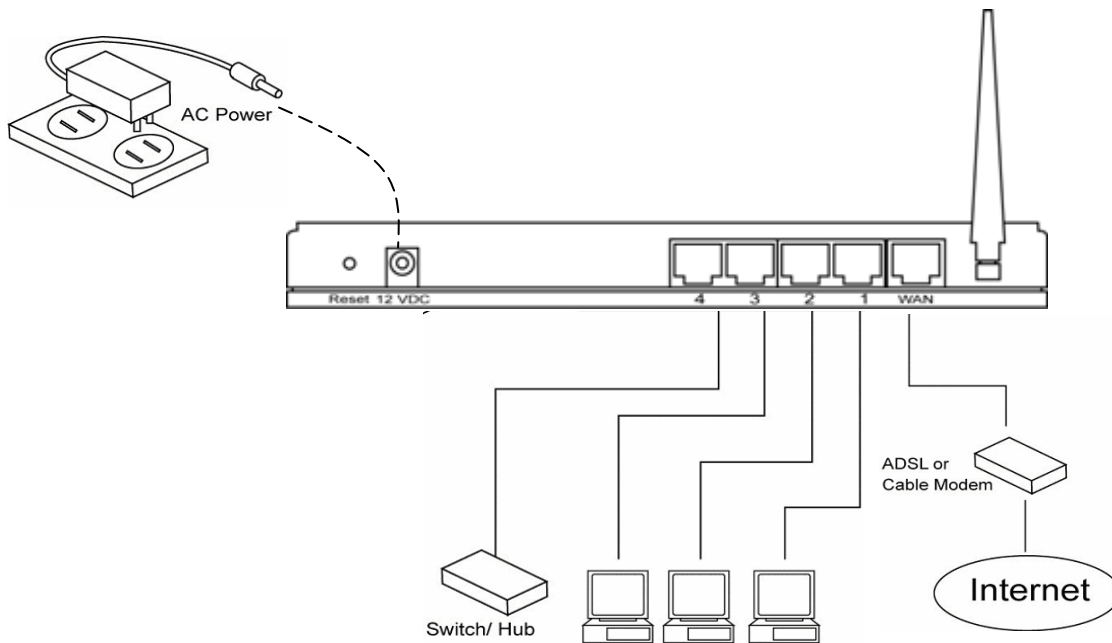

Figure 1.2

Getting started

This is a step-by-step instruction on how to start using the router and get connected to the Internet.

- 1) Setup your network as shown in the setup diagram above (fig 1.2).
- 2) You then need to set your LAN PC clients so that it can obtain an IP address automatically. All LAN clients require an IP address. Just like an address, it allows LAN clients to find one another. (If you have already configured your PC to obtain an IP automatically then proceed to step 3, page 13)

Configure your PC to obtain an IP address automatically

By default the VRT-401G's DHCP is on, this means that you can obtain an IP address automatically once you've configured your PC to obtain an IP address automatically. This section will show you how to configure your PC's so that it can obtain an IP address automatically for either Windows 95/98/Me, 2000 or NT operating systems. For other operating systems (Macintosh, Sun, etc.), follow the manufacturer's instructions. The following is a step-by-step illustration on how to configure your PC to obtain an IP address automatically for 2a) **Windows 95/98/Me**, 2b) **Windows XP**, 2c) **Windows 2000** and 2d) **Windows NT**.

2a) Windows 95/98/Me

- 1: Click the *Start* button and select *Settings*, then click *Control Panel*. The *Control Panel* window will appear.
- 2: Double-click *Network* icon. The *Network* window will appear.
- 3: Check your list of Network Components. If TCP/IP is not installed, click the *Add* button to install it now. If TCP/IP is installed, go to **step 6**.
- 4: In the *Network Component Type* dialog box, select *Protocol* and click *Add* button.
- 5: In the *Select Network Protocol* dialog box, select *Microsoft* and *TCP/IP* and then click the *OK* button to start installing the TCP/IP protocol. You may need your Windows CD to complete the installation.
- 6: After installing TCP/IP, go back to the *Network* dialog box. Select *TCP/IP* from the list of *Network Components* and then click the *Properties* button.
- 7: Check each of the tabs and verify the following settings:
 - **Bindings:** Check *Client for Microsoft Networks* and *File and printer sharing for Microsoft Networks*.
 - **Gateway:** All fields are blank.
 - **DNS Configuration:** Select *Disable DNS*.
 - **WINS Configuration:** Select *Disable WINS Resolution*.
 - **IP Address:** Select *Obtain IP address automatically*.

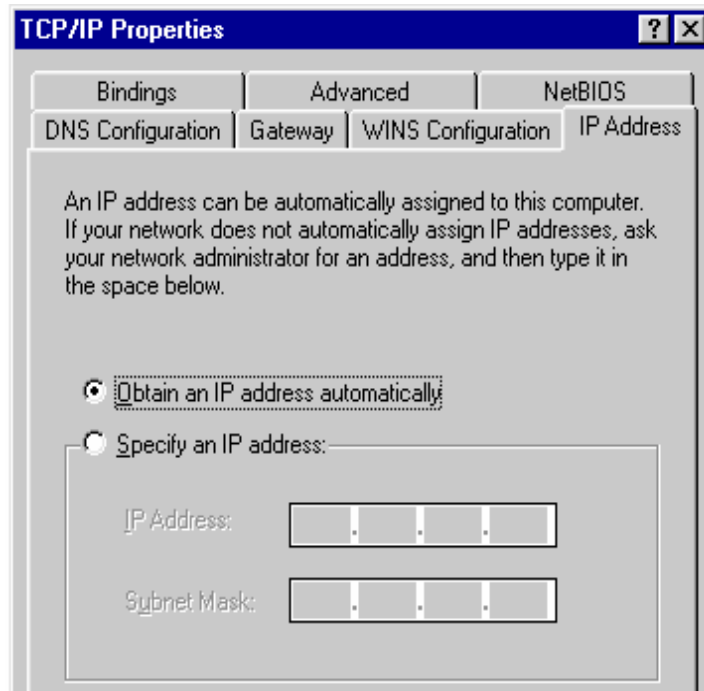

- 8: Reboot the PC. Your PC will now obtain an IP address automatically you're your Broadband Router's DHCP server.

Note: Please make sure that the Broadband router's DHCP server is the only DHCP server available on your LAN.

Once you've configured your PC to obtain an IP address automatically, please proceed to Step 3

2b) Windows XP

- 1: Click the *Start* button and select *Settings*, then click *Network Connections*. The *Network Connections* window will appear.
- 2: Double-click *Local Area Connection* icon. The *Local Area Connection* window will appear.
- 3: Check your list of Network Components. You should see *Internet Protocol [TCP/IP]* on your list. Select it and click the *Properties* button.
- 4: In the Internet Protocol (TCP/IP) Properties window, select *Obtain an IP address automatically* and *Obtain DNS server address automatically* as shown on the following screen.

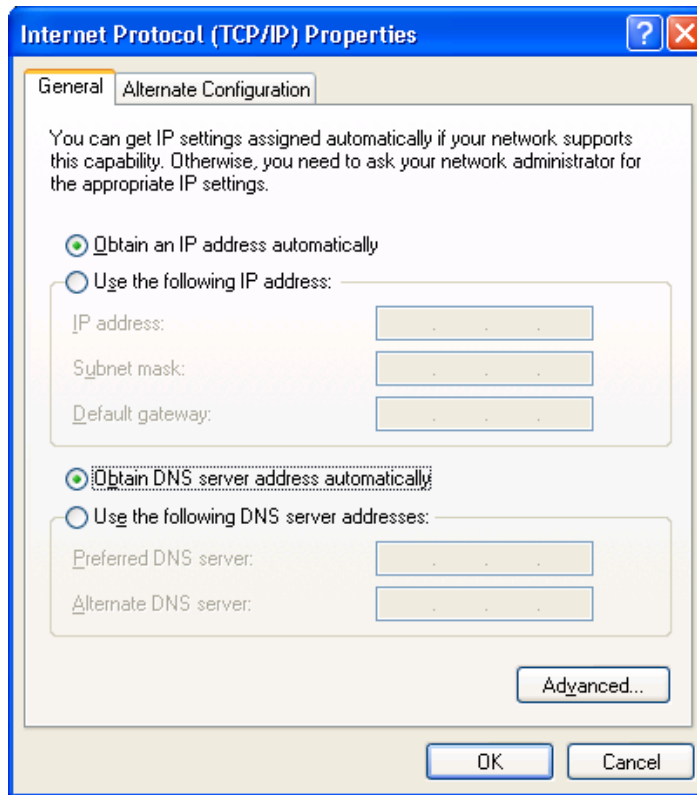

- 5: Click *OK* to confirm the setting. Your PC will now obtain an IP address automatically from your Broadband Router's DHCP server.

Note: Please make sure that the Broadband router's DHCP server is the only DHCP server available on your LAN.

Once you've configured your PC to obtain an IP address automatically, please proceed to Step 3.

2c) Windows 2000

- 1: Click the *Start* button and select *Settings*, then click *Control Panel*. The *Control Panel* window will appear.
- 2: Double-click *Network and Dial-up Connections* icon. In the *Network and Dial-up Connection* window, double-click *Local Area Connection* icon. The *Local Area Connection* window will appear.
- 3: In the *Local Area Connection* window, click the *Properties* button.
- 4: Check your list of Network Components. You should see *Internet Protocol [TCP/IP]* on your list. Select it and click the *Properties* button.
- 5: In the Internet Protocol (TCP/IP) Properties window, select *Obtain an IP address automatically* and *Obtain DNS server address automatically* as shown on the following screen.

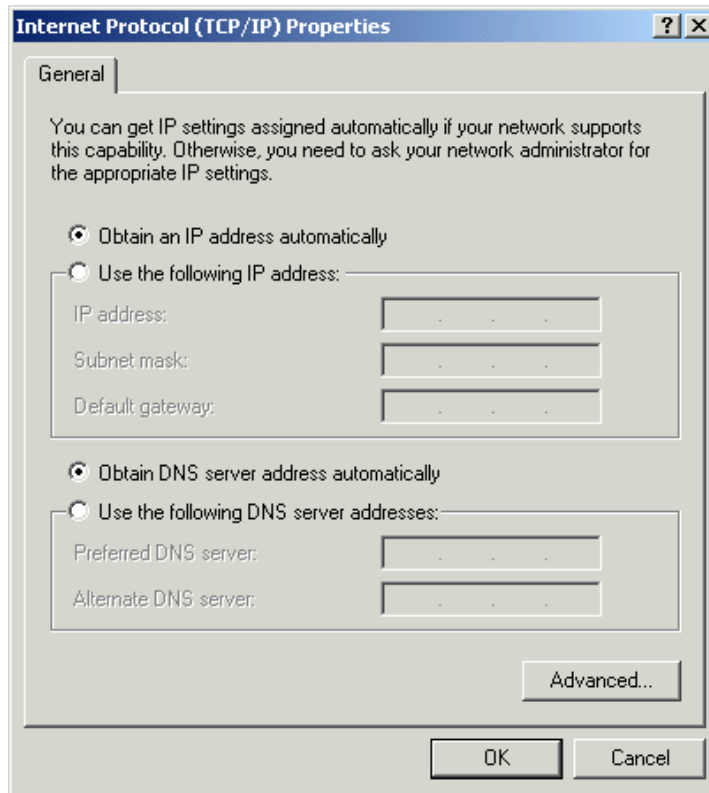

6: Click *OK* to confirm the setting. Your PC will now obtain an IP address automatically from your Broadband Router's DHCP server.

Note: Please make sure that the Broadband router's DHCP server is the only DHCP server available on your LAN.

Once you've configured your PC to obtain an IP address automatically, please proceed to Step 3.

2d) Windows NT

- 1: Click the *Start* button and select *Settings*, then click *Control Panel*. The *Control Panel* window will appear.
- 2: Double-click *Network* icon. The *Network* window will appear. Select the *Protocol* tab from the *Network* window.
- 3: Check if the *TCP/IP Protocol* is on your list of *Network Protocols*. If TCP/IP is not installed, click the *Add* button to install it now. If TCP/IP is installed, go to **step 5**.
- 4: In the *Select Network Protocol* window, select the *TCP/IP Protocol* and click the *Ok* button to start installing the TCP/IP protocol. You may need your Windows CD to complete the installation.
- 5: After you install TCP/IP, go back to the *Network* window. Select *TCP/IP* from the list of *Network Protocols* and then click the *Properties* button.

6: Check each of the tabs and verify the following settings:

- **IP Address:** Select *Obtain an IP address from a DHCP server*.
- **DNS:** Let all fields be blank.
- **WINS:** Let all fields be blank.
- **Routing:** Let all fields be blank.

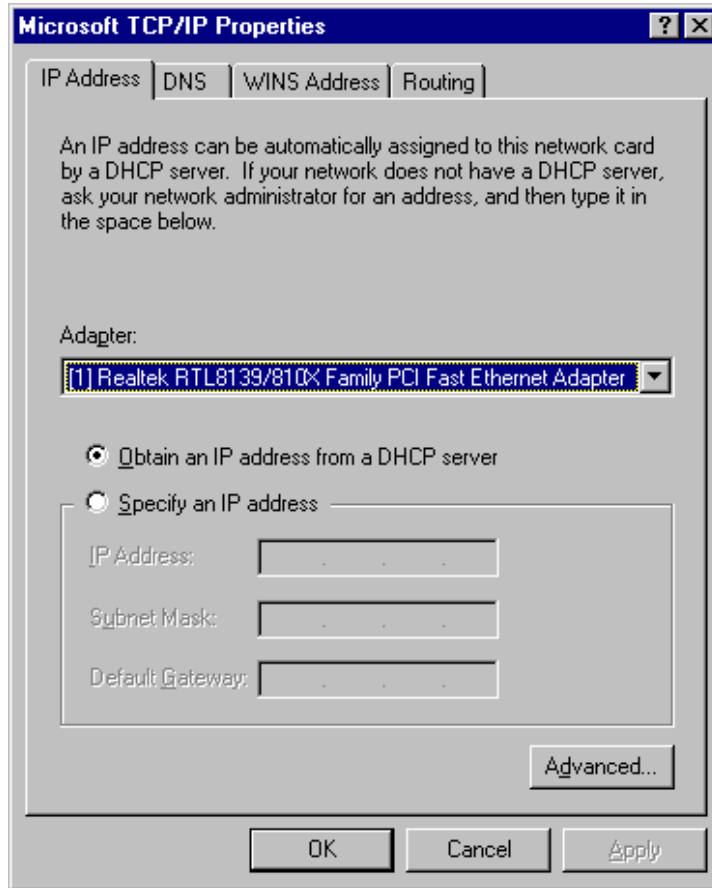

7: Click *OK* to confirm the setting. Your PC will now obtain an IP address automatically from your Broadband Router's DHCP server.

Note: Please make sure that the Broadband router's DHCP server is the only DHCP server available on your LAN.

Once you've configured your PC to obtain an IP address automatically, please proceed to Step 3.

- 3) Once you have configured your PCs to obtain an IP address automatically, the router's DHCP server will automatically give your LAN clients an IP address. By default the VRT-401G's DHCP server is enabled so that you can obtain an IP address automatically. To see if you have obtained an IP address, see Appendix A.

Note: Please make sure that the VRT-401G's DHCP server is the only DHCP server available on your LAN. If there is another DHCP on your network, then you'll need to switch one of the DHCP servers off. (To disable the VRT-401G's DHCP server see chapter 2 LAN Port)

- 4) Once your PC has obtained an IP address from your router, enter the default IP address **192.168.0.1** (VRT-401G's IP address) into your PC's web browser and press <enter>
- 5) The login screen below will appear. Enter the "User Name" and "Password" and then click <OK> to login.

Note: By default the user name is "admin" and the password is "admin". For security reasons it is recommended that you change the password as soon as possible (in General setup/system/password, see chapter 2)



- 6) The **HOME** page screen below will appear. The **Home** Page is divided into four sections, **Quick Setup Wizard**, **General Setup**, **Status Information** and **Tools**.

Quick Setup Wizard (*Chapter 1*)

If you only want to start using the VRT-401G as an Internet Access device then you **ONLY** need to configure the screens in the Quick Setup Wizard section.

General Setup (*Chapter 2*)

If you want to use more advanced features that the VRT-401G has to offer, then you'll need to configure the Quick Setup Wizard and the General Setup section. Alternatively, you can just configure the General Setup section, since the General Setup/WAN and the Quick Setup Wizard contain the same configurations.

Status Information (*Chapter 3*)

The Status Information section is for you to monitor the router's current status information only.

Tools (*Chapter 4*)

If you want to Reset the router (because of problems) or save your configurations or upgrade the firmware then the Tools section is the place to do this.



Menu	Description
Quick Setup Wizard (<i>Chapter 1</i>)	Select your Internet connection type and then input the configurations needed to connect to your Internet Service Provider (ISP).
General Setup (<i>Chapter 2</i>)	This section contains configurations for the VRT-401G's advance functions such as: Address Mapping, Virtual Server, Access Control, Hacker Attack Prevention, DMZ, Special applications and other functions to meet your LAN requirements.
Status Information (<i>Chapter 3</i>)	In this section you can see the VRT-401G's system information, Internet Connection, Device Status, System Log, Security Log and DHCP client information.
Tools (<i>Chapter 4</i>)	This section contains the VRT-401G's Tools - Tools include Configuration tools , Firmware upgrade and Reset . Configuration tools allow you to Backup (save), Restore , or Restore to Factory Default setting for your VRT-401G. The Firmware upgrade tool allows you to upgrade your VRT-401G's firmware. The RESET tool allows you to reset your VRT-401G.
Logout	Selecting logout will return you to the LOGIN page

- 7) **Click on Quick Setup Wizard (see chapter 1) to start configuring settings required by your ISP so that you can start accessing the Internet. The other sections (General Setup, Status Information and Tools) do not need to be configured unless you wish to implement/monitor more advance features/information.**

Select the section (Quick Setup Wizard, General Setup, Status Information and Tools) you wish to configure and proceed to the corresponding chapter. Use the selections on the web management's top right hand page (see below) to navigate around the web-based management User Interface.

[HOME](#) | [General Setup](#) | [Status](#) | [Tool](#)

Chapter 1

Quick Setup

The Quick Setup section is designed to get you using the VRT-401G as quickly as possible. In the Quick Setup you are required to fill in only the information necessary to access the Internet. Once you click on the **Quick Setup Wizard** in the HOME page, you should see the screen below.

Step 1) Time Zone

The Time Zone allows your router to be configured base on its time settings, this will affect functions such as Log entries and Firewall settings.

The screenshot shows the configuration interface for the Planet Internet Broadband Router. The page title is "Internet Broadband Router" and the navigation menu includes "HOME", "General Setup", "Status", and "Tools". The main heading is "1. Time Zone". Below the heading, there is a descriptive text: "Set the time zone of the Broadband router. This information is used for log entries and firewall settings." The configuration fields are: "Set Time Zone" with a dropdown menu showing "(GMT)Greenwich Mean Time: Dublin, Edinburgh, Lisbon, London"; "Time Server Address" with a text input field containing "192.43.244.18"; and "Daylight Savings" with a checkbox labeled "Enable Function" and two date pickers for "Times From" and "To", both set to "January 1". A "Next" button is located at the bottom right of the form.

Parameter	Description
Set Time Zone	Select the time zone of the country you are currently in. The router will set its time based on your selection.
Time Server Address	You can manually assign time server address if the default time server does not work.
Enable Daylight Savings	The router can also take Daylight savings into account. If you wish to use this function, you must check/tick the enable box to enable your daylight saving configuration (below).
Start Daylight Savings Time	Select the period in which you wish to start daylight Savings Time
End Daylight Savings Time	Select the period in which you wish to end daylight Savings Time

Click on **NEXT** to proceed to the next page (step 2) Broadband Type.

Step 2) Broadband Type

In this section you have to select one of four types of connections that you will be using to connect your VRT-401G's WAN port to your ISP (see screen below).

Note: Different ISP's require different methods of connecting to the Internet, please check with your ISP as to the type of connection it requires.

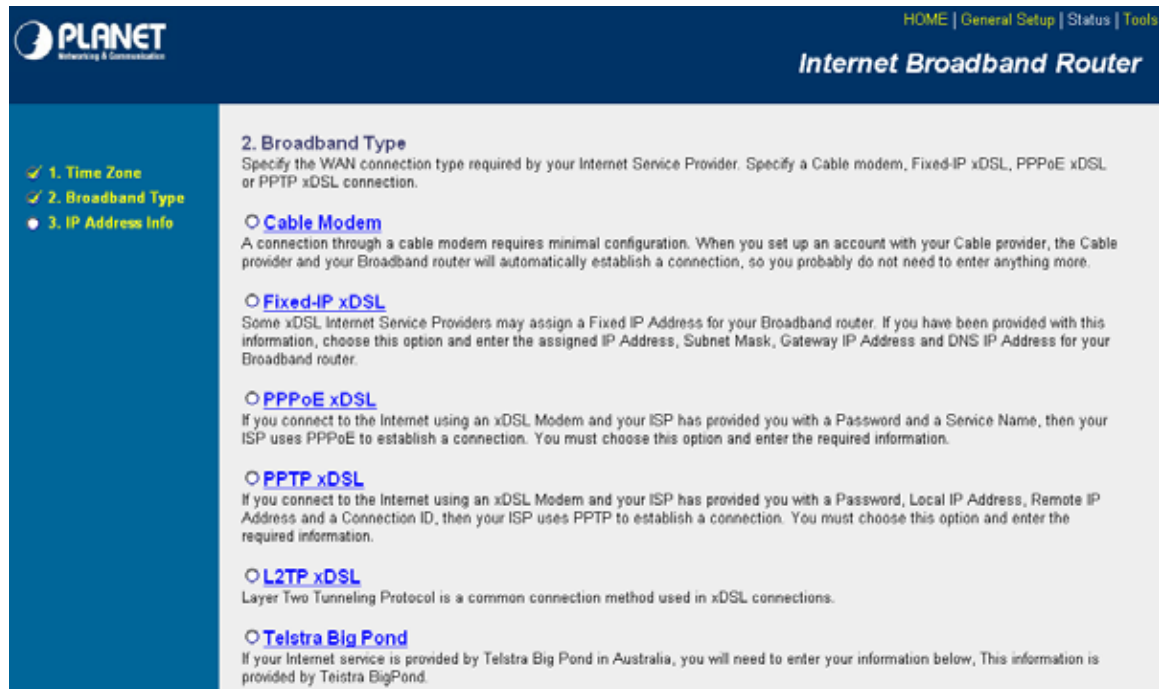

The screenshot shows the configuration interface for a Planet Internet Broadband Router. The page title is "Internet Broadband Router" and the navigation menu includes "HOME | General Setup | Status | Tools". The left sidebar shows a progress indicator with three steps: "1. Time Zone" (checked), "2. Broadband Type" (checked), and "3. IP Address Info" (active). The main content area is titled "2. Broadband Type" and instructs the user to "Specify the WAN connection type required by your Internet Service Provider. Specify a Cable modem, Fixed-IP xDSL, PPPoE xDSL or PPTP xDSL connection." There are six radio button options, each with a brief description: "Cable Modem", "Fixed-IP xDSL", "PPPoE xDSL", "PPTP xDSL", "L2TP xDSL", and "Telstra Big Pond".

Menu	Description
1.1 Cable Modem	Your ISP will automatically give you an IP address
1.2 Fixed-IP xDSL	Your ISP has given you an IP address already
1.3 PPPoE	Your ISP requires you to use a Point-to-Point Protocol over Ethernet (PPPoE) connection.
1.4 PPTP	Your ISP requires you to use a Point-to-Point Tunneling Protocol (PPTP) connection.
1.5 L2TP	Your ISP requires you to use a Layer Two Tunneling Protocol (L2TP) connection.
1.6 Telstra Big Pond	This Protocol only used for Australia's ISP connection.

Click on one of the WAN type and then proceed to the manual's relevant sub-section (**1.1**, **1.2**, **1.3**, **1.4**, **1.5** or **1.6**). Click on **Back** to return to the previous screen.

1.1 Cable Modem

Choose Cable Modem if your ISP will automatically give you an IP address. Some ISP's may also require that you fill in additional information such as Host Name and MAC address (see screen below).

Note: The Host Name and MAC address section is *optional* and you can skip this section if your ISP does not require these settings for you to connect to the Internet.

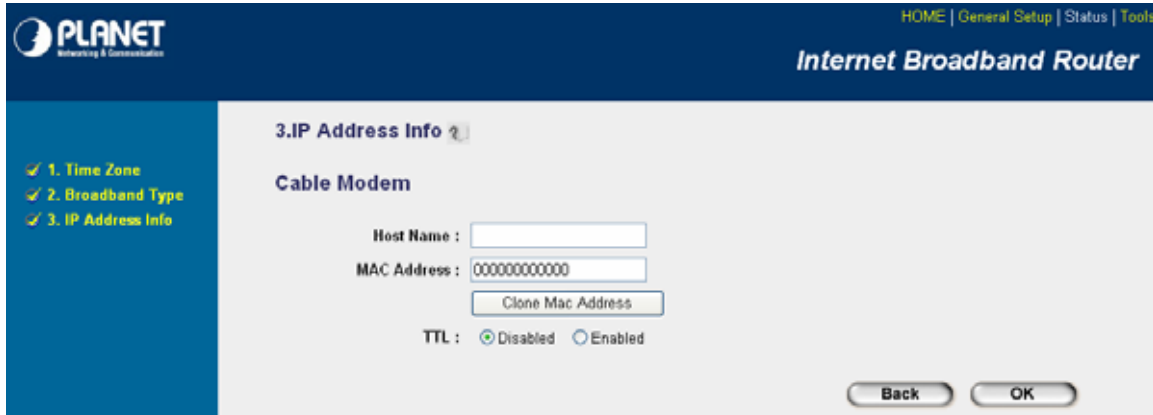

Parameters	Description
Host Name	If your ISP requires a Host Name, type in the host name provided by your ISP, otherwise leave it blank if your ISP does not require a Host Name.
MAC Address	Your ISP may require a particular MAC address in order for you to connect to the Internet. This MAC address is the PC's MAC address that your ISP had originally connected your Internet connection to. Type in this MAC address in this section or use the " Clone MAC Address " button to replace the WAN MAC address with the MAC address of that PC (you have to be using that PC for the Clone MAC Address button to work). To find out the PC's MAC address see Appendix A. (see Glossary for an explanation on MAC address)
TTL	This is optional. Some ISP will check the TTL response to build up the connection. When you select Enabled, VRT-401G will respond the TTL time plus 1.

Click **<OK>** when you have finished the configuration above. **Congratulations!** You have completed the configuration for the Cable Modem connection. You can start using the router now, if you wish to use some of the advance features supported by this router see chapter 2, 3, 4.

1.2 Fixed-IP xDSL

Select Fixed-IP xDSL if your ISP has given you a specific IP address for you to use. Your ISP should provide all the information required in this section.

HOME | General Setup | Status | Tools

Internet Broadband Router

- ✓ 1. Time Zone
- ✓ 2. Broadband Type
- ✓ 3. IP Address Info

3. IP Address Info ?

Fixed-IP xDSL
Enter the IP Address, Subnet Mask, Gateway IP Address and DNS IP Address provided to you by your ISP in the appropriate fields.

IP address assigned by your Service Provider :	<input type="text" value="192.168.99.99"/>
Subnet Mask :	<input type="text" value="255.255.255.0"/>
DNS Address :	<input type="text" value="168.95.1.1"/>
Service Provider Gateway Address :	<input type="text" value="192.168.99.253"/>
TTL :	<input checked="" type="radio"/> Disabled <input type="radio"/> Enabled

Parameters	Description
IP	This is the IP address that your ISP has given you.
Subnet Mask	Enter the Subnet Mask provided by your ISP (e.g. 255.255.255.0)
DNS	This is the ISP's DNS server IP address
Gateway IP	This is the ISP's IP address gateway
TTL	This is optional. Some ISP will check the TTL response to build up the connection. When you select Enabled, VRT-401G will respond the TTL time plus 1.

Click **<OK>** when you have finished the configuration above. **Congratulations!** You have completed the configuration for the Fixed-IP x DSL connection. You can start using the router now, if you wish to use some of the advance features supported by this router see chapter 2, 3, 4.

1.3 PPPoE

Select PPPoE if your ISP requires the PPPoE protocol to connect you to the Internet. Your ISP should provide all the information required in this section.

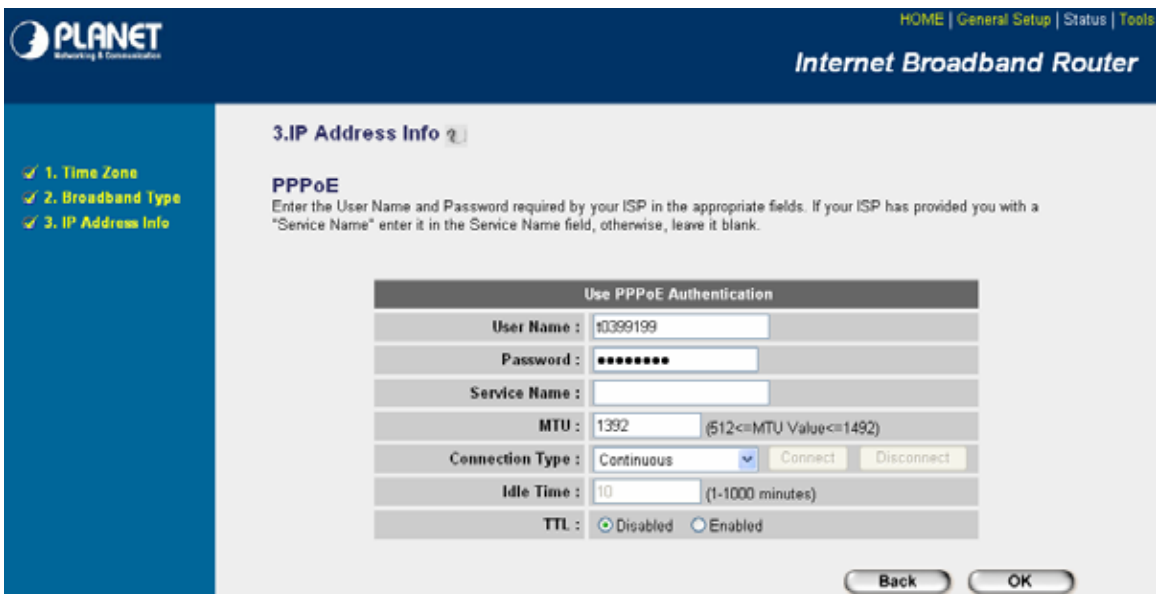

Parameter	Description
User Name	Enter the User Name provided by your ISP for the PPPoE connection
Password	Enter the Password provided by your ISP for the PPPoE connection
Service Name	This is optional. Enter the Service name should your ISP requires it, otherwise leave it blank.
MTU	This is optional. You can specify the maximum size of your transmission packet to the Internet. Leave it as it is if you to not wish to set a maximum packet size.
Connection Type	If you select "Continuous", the router will always connect to the ISP. If the WAN line breaks down and links again, the router will auto-reconnect to the ISP. If you select "Connect On Demand", the router will auto-connect to the ISP when someone want to use the Internet and keep connected until the WAN idle timeout. The router will close the WAN connection if the time period that no one is using the Internet exceeds the "Idle Time". If you select "Manual", the router will connect to ISP only when you click "Connect" manually from the Web user interface. The WAN connection will not disconnect due to the idle timeout. If the WAN line breaks down and latter links again, the router will not auto-connect to the ISP.
Idle Time	You can specify an idle time threshold (minutes) for the WAN port. This means if no packets have been sent (no one using the Internet) during this specified period, the router will automatically disconnect the connection with your ISP.

Note: This “idle timeout” function may not work due to abnormal activities of some network application software, computer virus or hacker attacks from the Internet. For example, some software sends network packets to the Internet in the background, even when you are not using the Internet. So please turn off your computer when you are not using it. This function also may not work with some ISP. So please make sure this function can work properly when you use this function in the first time, especially your ISP charge you by time used.

TTL

This is optional. Some ISP will check the TTL response to build up the connection. When you select Enabled, VRT-401G will respond the TTL time plus 1

Click <OK> when you have finished the configuration above. **Congratulations!** You have completed the configuration for the PPPoE connection. You can start using the router now, if you wish to use some of the advance features supported by this router see chapter 2, 3, 4.

1.4 PPTP

Select PPTP if your ISP requires the PPTP protocol to connect you to the Internet. Your ISP should provide all the information required in this section.

The screenshot shows the configuration interface for a Planet Internet Broadband Router. The page title is "Internet Broadband Router" and the navigation menu includes "HOME", "General Setup", "Status", and "Tools". The current page is "3. IP Address Info", which is part of a sequence of steps: "1. Time Zone", "2. Broadband Type", and "3. IP Address Info".

The "PPTP" section is active, with the description: "Point-to-Point Tunneling Protocol is a common connection method used in xDSL connections." It is divided into two main sections:

- WAN Interface Settings:**
 - Obtain an IP address automatically:
 - Host Name: []
 - MAC Address: 000000000000 [Clone Mac]
 - Use the following IP address:
 - IP Address: 0.0.0.0
 - Subnet Mask: 0.0.0.0
 - Default Gateway: 0.0.0.0
- PPTP Settings:**
 - User ID: []
 - Password: []
 - PPTP Gateway: 0.0.0.0
 - Connection ID: [] (Optional)
 - MTU: 1392 (512<=MTU Value<=1492)
 - BEZEQ-ISRAEL: Enable (for BEZEQ network in ISRAEL use only)
 - Connection Type: Continuous [Connect] [Disconnect]
 - Idle Time Out: 10 (1-1000 minutes)

At the bottom right, there are "Back" and "OK" buttons.

Parameter	Description
Obtain an IP address automatically	The ISP requires you to obtain an IP address by DHCP before connecting to the PPTP server.
MAC Address	Your ISP may require a particular MAC address in order for you to connect to the Internet. This MAC address is the PC's MAC address that your ISP had originally connected your Internet connection to. Type in this MAC address in this section or use the "Clone MAC Address" button to replace the WAN MAC address with the MAC address of that PC (you have to be using that PC for the Clone MAC Address button to work). To find out the PC's MAC address see Appendix A. (see Glossary for an explanation on MAC address)
Use the following IP address	The ISP gives you a static IP to be used to connect to the PPTP server.
IP Address	This is the IP address that your ISP has given you to establish a PPTP connection.
Subnet Mask	Enter the Subnet Mask provided by your ISP (e.g. 255.255.255.0)
Gateway	Enter the IP address of the ISP Gateway
User ID	Enter the User Name provided by your ISP for the PPTP connection. Sometimes called a Connection ID
Password	Enter the Password provided by your ISP for the PPTP connection
PPTP Gateway	If your LAN has a PPTP gateway, then enter that PPTP gateway IP address here. If you do not have a PPTP gateway then enter the ISP's Gateway IP address above
Connection ID	This is the ID given by ISP. This is optional.
MTU	This is optional. You can specify the maximum size of your transmission packet to the Internet. Leave it as it is if you do not wish to set a maximum packet size.
BEZEQ-ISRAEL	Select this item if you are using the service provided by BEZEQ in Israel.
Connection Type	If you select "Continuous", the router will always connect to the ISP. If the WAN line breaks down and links again, the router will auto-reconnect to the ISP. If you select "Connect On Demand", the router will auto-connect to the ISP when someone wants to use the Internet and keep connected until the WAN idle timeout. The router will close the WAN connection if the time period that no one is using the Internet exceeds the "Idle Time". If you select "Manual", the router will connect to ISP only when you click "Connect" manually from the Web user interface. The

WAN connection will not disconnect due to the idle timeout. If the WAN line breaks down and latter links again, the router will not auto-connect to the ISP.

Idle Time

You can specify an idle time threshold (minutes) for the WAN port. This means if no packets have been sent (no one using the Internet) throughout this specified period, then the router will automatically disconnect the connection with your ISP.

Note: This “idle timeout” function may not work due to abnormal activities of some network application software, computer virus or hacker attacks from the Internet. For example, some software sends network packets to the Internet in the background, even when you are not using the Internet. So please turn off your computer when you are not using it. This function also may not work with some ISP. So please make sure this function can work properly when you use this function in the first time, especially your ISP charge you by time used.

Click <OK> when you have finished the configuration above. **Congratulations!** You have completed the configuration for the PPTP connection. You can start using the router now, if you wish to use some of the advance features supported by this router see chapter 2, 3, 4.

1.5 L2TP

Select L2TP if your ISP requires the L2TP protocol to connect you to the Internet. Your ISP should provide all the information required in this section.

The screenshot shows the configuration interface for a Planet Internet Broadband Router. The page title is "Internet Broadband Router" and the navigation menu includes "HOME | General Setup | Status | Tools". The current page is "3. IP Address Info", which is highlighted in the left sidebar. The sidebar also shows "1. Time Zone" and "2. Broadband Type" as completed steps. The main content area is titled "L2TP" and includes a description: "Layer Two Tunneling Protocol is a common connection method used in xDSL connections." Under "WAN Interface Settings", the "Obtain an IP address automatically" option is selected. The "Use the following IP address" option is unselected. The "L2TP Settings" section includes fields for "User ID", "Password", "L2TP Gateway", "MTU" (set to 1392), "Connection Type" (set to Continuous), and "Idle Time Out" (set to 10 minutes). The "Connect" and "Disconnect" buttons are visible next to the "Connection Type" dropdown. At the bottom right, there are "Back" and "OK" buttons.

Parameter	Description
Obtain an IP address automatically	The ISP requires you to obtain an IP address by DHCP before connecting to the L2TP server.
MAC Address	Your ISP may require a particular MAC address in order for you to connect to the Internet. This MAC address is the PC's MAC address that your ISP had originally connected your Internet connection to. Type in this MAC address in this section or use the "Clone MAC Address" button to replace the WAN MAC address with the MAC address of that PC (you have to be using that PC for the Clone MAC Address button to work). To find out the PC's MAC address see Appendix A. (see Glossary for an explanation on MAC address)
Use the following IP address	The ISP gives you a static IP to be used to connect to the L2TP server.
IP Address	This is the IP address that your ISP has given you to establish a L2TP connection.
Subnet Mask	Enter the Subnet Mask provided by your ISP (e.g. 255.255.255.0)
Gateway	Enter the IP address of the ISP Gateway
User ID	Enter the User Name provided by your ISP for the L2TP connection. Sometimes called a Connection ID
Password	Enter the Password provided by your ISP for the L2TP connection
L2TP Gateway	If your LAN has a L2TP gateway, then enter that L2TP gateway IP address here. If you do not have a L2TP gateway then enter the ISP's Gateway IP address above
MTU	This is optional. You can specify the maximum size of your transmission packet to the Internet. Leave it as it is if you do not wish to set a maximum packet size.
Connection Type	<p>If you select "Continuous", the router will always connect to the ISP. If the WAN line breaks down and links again, the router will auto-reconnect to the ISP.</p> <p>If you select "Connect On Demand", the router will auto-connect to the ISP when someone want to use the Internet and keep connected until the WAN idle timeout. The router will close the WAN connection if the time period that no one is using the Internet exceeds the "Idle Time".</p> <p>If you select "Manual", the router will connect to ISP only when you click "Connect" manually from the Web user interface. The WAN connection will not be disconnected due to the idle timeout. If the WAN line breaks down and latter links again, the router will not auto-connect to the ISP.</p>

Idle Time Out

The WAN "idle timeout" auto-disconnect function may not work due to abnormal activities of some network application software, computer virus or hacker attacks from the Internet. For example, some software sends network packets to the Internet in the background, even when you are not using the Internet. This function also may not work with some ISP. So please make sure this function can work properly when you use this function in the first time, especially your ISP charge you by time used. Due to the many uncontrollable issues, we do not guarantee the WAN "idle timeout" auto-disconnect function will always work. In order to prevent from extra fee charged by ISP, please **TURN OFF THE ROUTER WHEN YOU FINISHED USING THE INTERNET.**

Click **<OK>** when you have finished the configuration above. **Congratulations!** You have completed the configuration for the L2TP connection. You can start using the router now, if you wish to use some of the advance features supported by this router see chapter 2, 3, 4.

1.6 Telstra Big Pond

Select Telstra Big Pond if your ISP requires the Telstra Big Pond protocol to connect you to the Internet. Your ISP should provide all the information required in this section. Telstra Big Pond protocol is used by the ISP in Australia.

The screenshot shows the configuration interface for a Planet Internet Broadband Router. The page title is "Internet Broadband Router" and the section is "3. IP Address Info". Underneath, it is titled "Telstra Big Pond (Australia Only)" and includes a note: "If your Internet service is provided by Telstra Big Pond in Australia, you will need to enter your information below, This information is provided by Telstra BigPond." The form contains the following fields: "User Name" (text input), "Password" (password input), a checkbox labeled "User decide login server manually", and "Login Server" (text input with "0000" pre-filled). At the bottom right, there are "Back" and "OK" buttons. A sidebar on the left lists navigation options: "1. Time Zone", "2. Broadband Type", and "3. IP Address Info" (which is currently selected).

Parameter	Description
User Name	Enter the User Name provided by your ISP for the Telstra Big Pond connection.
Password	Enter the Password provided by your ISP for the Telstra Big Pond connection.
User decide login server manually	Select if you want to assign the IP of Telstra Big Pond's login server manually.
Login Server	The IP of the Login Server.

Click **<OK>** when you have finished the configuration above. **Congratulations!** You have completed the configuration for the Telstra Big Pond connection. You can start using the router now, if you wish to use some of the advance features supported by this router see chapter 2, 3, 4.

Chapter 2

General Settings

Once you click on the **General Setup** button at the Home Page, you should see the screen below.

If you have already configured the Quick Setup Wizard you do NOT need to configure anything thing in the General Setup screen for you to start using the Internet.

The General Setup contains advanced features that allow you to configure the router to meet your network's needs such as: Wireless, Address Mapping, Virtual Server, Access Control, Hacker Attack Prevention, Special Applications, DMZ and other functions.

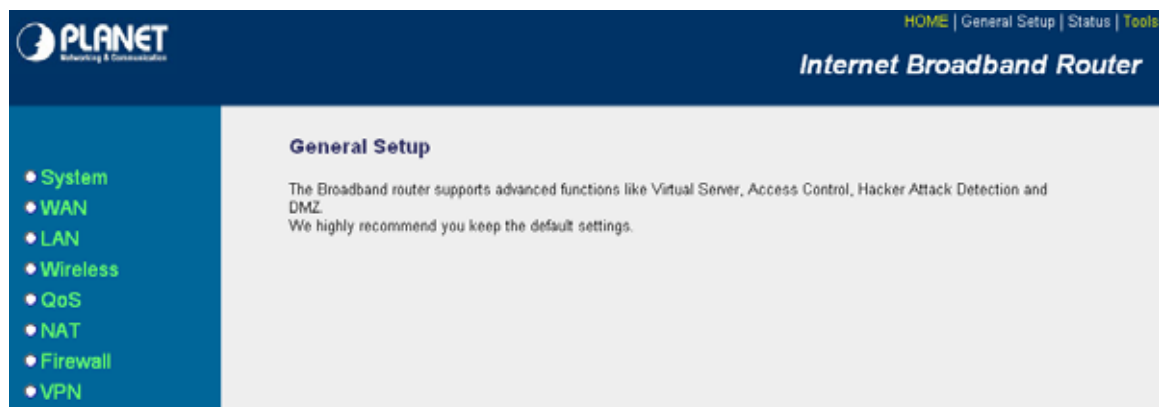

Below is a general description of what advance functions are available for this broadband router.

Menu	Description
2.1 System	This section allows you to set the VRT-401G's system Time Zone, Password and Remote Management Administrator.
2.2 WAN	This section allows you to select the connection method in order to establish a connection with your ISP (same as the Quick Setup Wizard section)
2.3 LAN	You can specify the LAN segment's IP address, Subnet Mask, enable/disable DHCP and select an IP range for your LAN
2.4 Wireless	You can setup the wireless LAN's SSID, WEP key, MAC filtering.
2.5 QoS	You can setup the QoS bandwidth control policy.
2.6 NAT	You can configure the Address Mapping, Virtual Server and Special Applications functions in this section. This allows you to specify what user/packet can pass your router's NAT.
2.7 Firewall	The Firewall section allows you to configure Access Control, Hacker Prevention and DMZ.
2.8 VPN	The VPN section allows you to configure VPN Server.

Select one of the above five General Setup selections and proceed to the manual's relevant sub-section

2.1 System

The system screen allows you to specify a time zone, to change the system password and to specify a remote management user for the VRT-401G

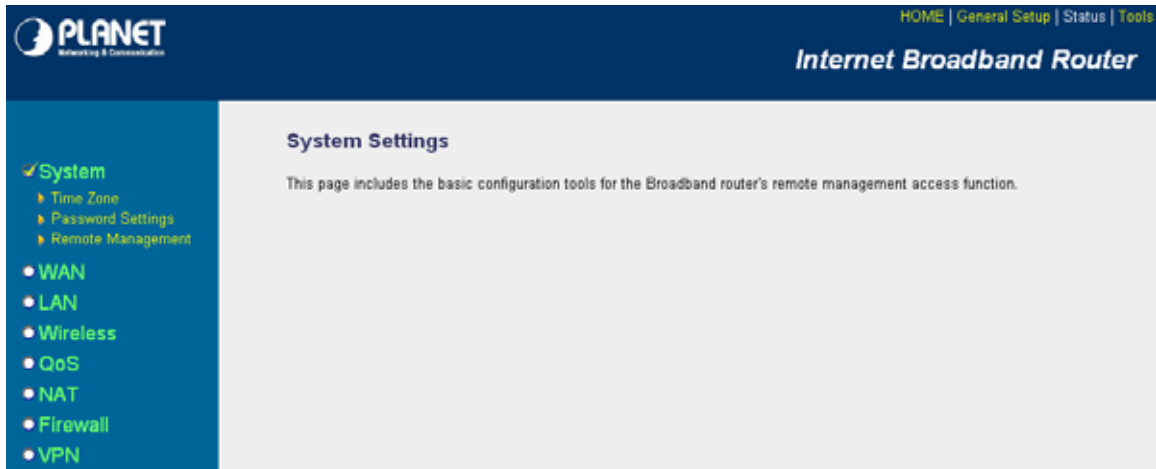

Parameters	Description
<i>System Settings</i>	
2.1.1 Time Zone	Select the time zone of the country you are currently in. The router will set its time based on your selection.
2.1.2 Password Settings	Allows you to select a password in order to access the web-based management website.
2.1.3 Remote Management	You can specify a Host IP address that can perform remote management functions.

Select one of the above three system settings selections and proceed to the manual's relevant sub-section

2.1.1 Time Zone

The Time Zone allows your router to refer or base its time on the settings, which will affect functions such as Log entries and Firewall settings.

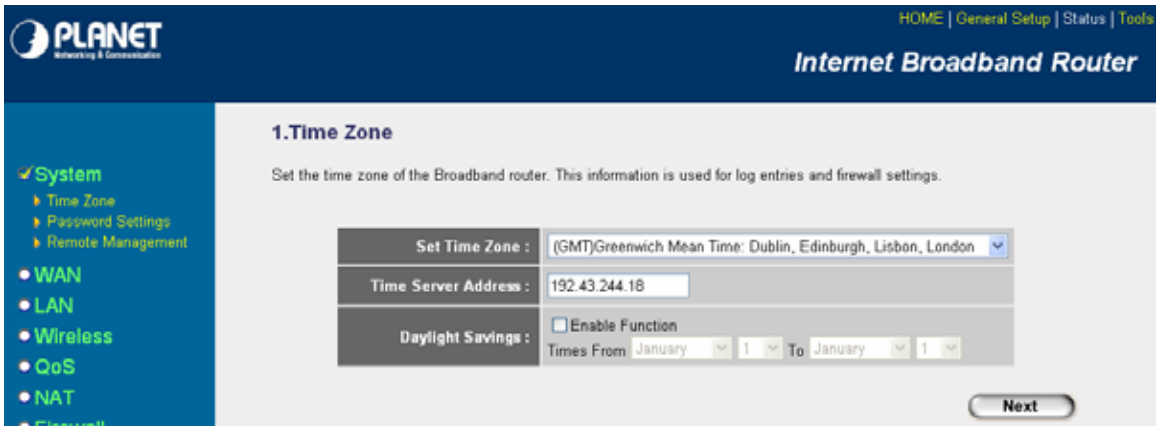

Parameter	Description
Set Time Zone	Select the time zone of the country you are currently in. The router will set its time based on your selection.
Time Server Address	The router default the "Time Server Address" is "192.43.244.18"
Enable Daylight Savings	The router can also take Daylight savings into account. If you wish to use this function, you must check/tick the enable box to enable your daylight saving configuration (below).
Start Daylight Savings Time	Select the period in which you wish to start daylight Savings Time
End Daylight Savings Time	Select the period in which you wish to end daylight Savings Time

Click **<Apply>** at the bottom of the screen to save the above configurations. You can now configure other advance sections or start using the router (with the advance settings in place)

2.1.2 Password Settings

You can change the password required to log into the VRT-401G's system web-based management. By default, the password is admin. So please assign a password to the Administrator as soon as possible, and store it in a safe place. Passwords can contain 0 to 12 alphanumeric characters, and are case sensitive.

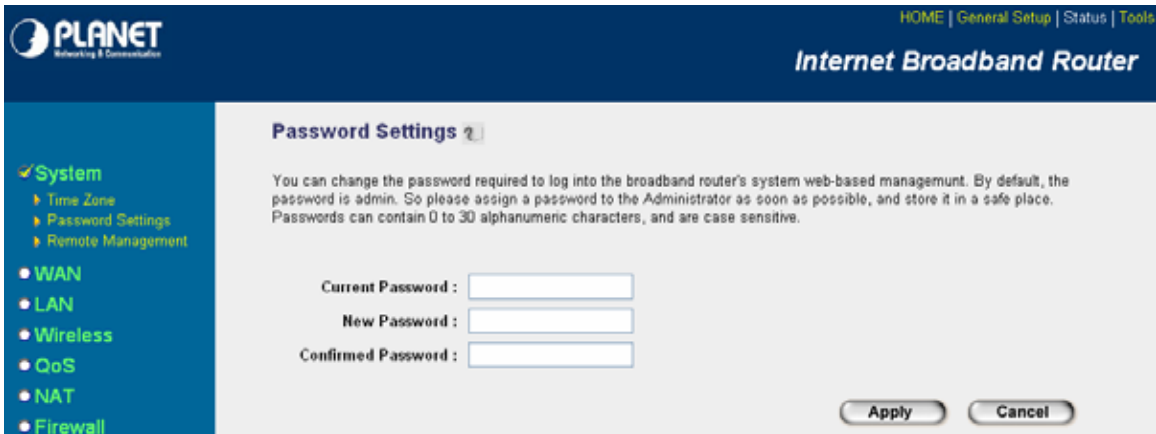

Parameters	Description
Current Password	Enter your current password for the remote management administrator to login to your VRT-401G. Note: By default the password is admin
New Password	Enter your new password
Confirmed Password	Enter your new password again for verification purposes Note: If you forget your password, you'll have to reset the router to the factory default with the reset button (see router's back panel)

Click <**Apply**> at the bottom of the screen to save the above configurations. You can now configure other advance sections or start using the router (with the advance settings in place)

2.1.3 Remote Management

The remote management function allows you to designate a host in the Internet the ability to configure the VRT-401G from a remote site. Enter the designated host IP Address in the Host IP Address field.

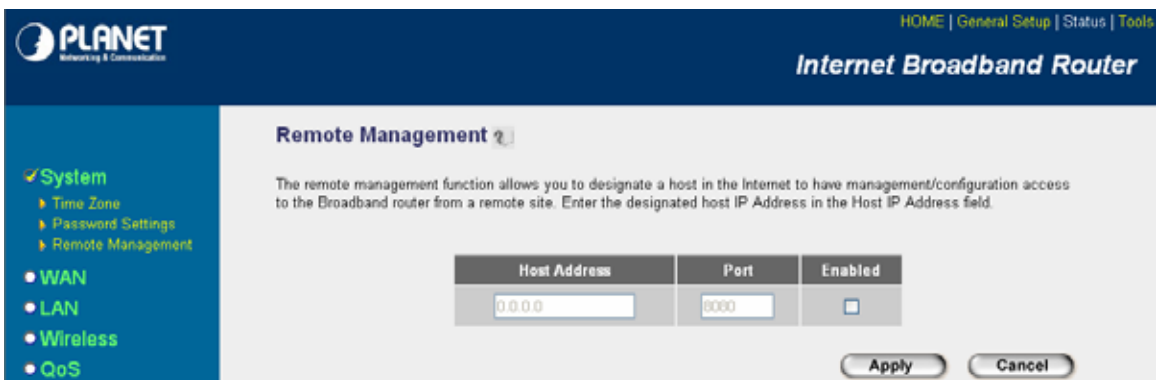

Parameters	Description
------------	-------------

Host Address This is the IP address of the host in the Internet that will have management/configuration access to the VRT-401G from a remote site. This means if you are at home and your home IP address has been designated the Remote Management host IP address for this router (located in your company office), then you are able to configure this router from your home. If the Host Address is left **0.0.0.0** this means anyone can access the router's web-based configuration from a remote location, providing they know the password.

Click the **Enabled** box to enable the Remote Management function.

Note: When you want to access the web-based management from a remote site, you must enter the router's WAN IP address (e.g. 10.0.0.1) into your web-browser followed by port number 8080, e.g. <http://10.0.0.1:8080>. You'll also need to know the password set in the Password Setting screen in order to access the router's web-based management.

Port The port number of remote management web interface.

Enabled Select "Enabled" to enable the remote management function.

Click **<Apply>** at the bottom of the screen to save the above configurations. You can now configure other advance sections or start using the router (with the advance settings in place)

2.2 WAN

Use the WAN Settings screen if you have already configured the Quick Setup Wizard section and you would like to change your Internet connection type. The WAN Settings screen allows to specify the type of WAN port connect you want to establish with your ISP. The WAN settings offer the following selections for the router's WAN port, **Dynamic IP**, **Static IP Address**, **PPPoE**, **PPTP**, **L2TP**, **Telstra Big Pond**, **DNS** and **DDNS**.

The screenshot shows the WAN Settings page of a Planet Internet Broadband Router. The page has a dark blue header with the Planet logo and navigation links (HOME, General Setup, Status, Tools). The main content area is titled 'WAN Settings' and includes a sub-header: 'The Broadband router can be connected to your Service Provider through the following methods:'. Below this, there are six radio button options, each with a description:

- Dynamic IP**: Obtains an IP Address automatically from your Service Provider.
- Static IP Address**: Uses a Static IP Address. Your Service Provider gives a Static IP Address to access Internet services.
- PPPoE**: PPP over Ethernet is a common connection method used in xDSL connections.
- PPTP**: Point-to-Point Tunneling Protocol is a common connection method used in xDSL connections.
- L2TP**: Layer Two Tunneling Protocol is a common connection method used in xDSL connections.
- Telstra Big Pond**: Telstra Big Pond is a Internet service is provided in Australia.

At the bottom of the list is a button labeled 'More Configuration'.

Parameters	Description
2.2.1 Dynamic IP address	Your ISP will automatically give you an IP address
2.2.2 Static IP address	Your ISP has given you an IP address already
2.2.3 PPPoE	Your ISP requires PPPoE connection.
2.2.4 PPTP	Your ISP requires you to use a Point-to-Point Tunneling Protocol (PPTP) connection.
2.2.5 L2TP	Your ISP requires L2TP connection.
2.2.6 Telstra Big Pond	Your ISP requires Telstra Big Pond connection.
2.2.7 DNS	You can specify a DNS server that you wish to use
2.2.8 DDNS	You can specify a DDNS server that you wish to use and configure the user name and password provided by you DDNS service provider.

Once you have made a selection, click **<More Configuration>** at the bottom of the screen, and proceed to the manual's relevant sub-section

2.2.1 Dynamic IP

Choose the Dynamic IP selection if your ISP will automatically give you an IP address. Some ISP's may also require you to fill in additional information such as Host Name, Domain Name and MAC address (see chapter 1 "Cable Modem" for more detail)

2.2.2 Static IP Address

Select Static IP address if your ISP has given you a specific IP address for you to use. Your ISP should provide all the information required in this section. (See chapter 1 "Fixed IP" for more detail)

2.2.3 PPPoE (PPP over Ethernet)

Select PPPoE if your ISP requires the PPPoE protocol to connect you to the Internet. Your ISP should provide all the information required in this section. (See chapter 1 "PPPoE" for more detail)

2.2.4 PPTP

Select PPTP if your ISP requires the PPTP protocol to connect you to the Internet. Your ISP should provide all the information required in this section. (See chapter 1 "PPTP" for more detail)

2.2.5 L2TP

Select L2TP if your ISP requires the L2TP protocol to connect you to the Internet. Your ISP should provide all the information required in this section. (See chapter 1 “L2TP” for more detail)

2.2.6 Telstra Big Pond

Select Telstra Big Pond if your ISP requires the Telstra Big Pond protocol to connect you to the Internet. Your ISP should provide all the information required in this section. Telstra Big Pond protocol is used by the ISP in Australia. (See chapter 1 “Telstra Big Pond” for more detail)

2.2.7 DNS

A Domain Name System (DNS) server is like an index of IP addresses and Web addresses. If you type a Web address into your browser, such as www.router.com, a DNS server will find that name in its index and the matching IP address. Most ISPs provide a DNS server for speed and convenience. If your Service Provider connects you to the Internet with dynamic IP settings, it is likely that the DNS server IP address is provided automatically. However, if there is a DNS server that you would rather use, you need to specify the IP address of that DNS server here.

PLANET
Networking & Communication

HOME | General Setup | Status | Tools

Internet Broadband Router

DNS

A Domain Name System (DNS) server is like an index of IP Addresses and Web Addresses. If you type a Web address into your browser, such as www.broadbandrouter.com, a DNS server will find that name in its index and find the matching IP address. Most ISPs provide a DNS server for speed and convenience. Since your Service Provider may connect you to the Internet through dynamic IP settings, it is likely that the DNS server IP Address is also provided dynamically. However, if there is a DNS server that you would rather use, you need to specify the IP Address of that DNS server. The primary DNS will be used for domain name access first, in case the primary DNS access failures, the secondary DNS will be used. Has your Internet service provider given you a DNS address?

Domain Name Server (DNS) Address :

Secondary DNS Address (optional) :

Apply Cancel

- System
- ✓ WAN
 - Dynamic IP
 - Static IP
 - PPPoE
 - PPTP
 - L2TP
 - Telstra Big Pond
 - DNS
 - DDNS
- LAN
- Wireless
- OnS

Parameters	Description
Domain Name Server (DNS) Server	This is the ISP's DNS server IP address that they gave you; or you can specify your own preferred DNS server IP address
Secondary DNS Address (optional)	This is optional. You can enter another DNS server's IP address as a backup. The secondary DNS will be used should the above DNS fail.

Click **<Apply>** at the bottom of the screen to save the above configurations. You can now configure other advance sections or start using the router (with the advance settings in place)

2.2.8 DDNS

DDNS allows you to map the static domain name to a dynamic IP address. You must get an account, password and your static domain name from the DDNS service providers. This router supports DynDNS, TZO and other common DDNS service providers.

The screenshot shows the DDNS configuration interface. At the top left is the Planet logo. The top right has navigation links: HOME | General Setup | Status | Tools. The page title is 'Internet Broadband Router'. The left sidebar lists menu items: System, WAN (selected), LAN, Wireless, QoS, NAT. The main area is titled 'DDNS' and contains a help icon and a paragraph explaining DDNS. Below this is a form with the following fields: 'Dynamic DNS' with radio buttons for 'Enable' and 'Disable'; 'Provider' with a dropdown menu set to 'DynDNS'; 'Domain Name' with a text input field; 'Account / E-Mail' with a text input field; and 'Password / Key' with a text input field. At the bottom right are 'Apply' and 'Cancel' buttons.

Parameters	Default	Description
Enable/Disable	Disable	Enable/Disable the DDNS function of this router
Provider		Select a DDNS service provider
Domain name		Your static domain name that use DDNS
Account/E-mail		The account that your DDNS service provider assigned to you
Password/Key		The password you set for the DDNS service account above

Click **<Apply>** at the bottom of the screen to save the above configurations. You can now configure other advance sections or start using the router (with the advance settings in place)

2.3 LAN

The LAN Port screen below allows you to specify a private IP address for your router's LAN ports as well as a subnet mask for your LAN segment.

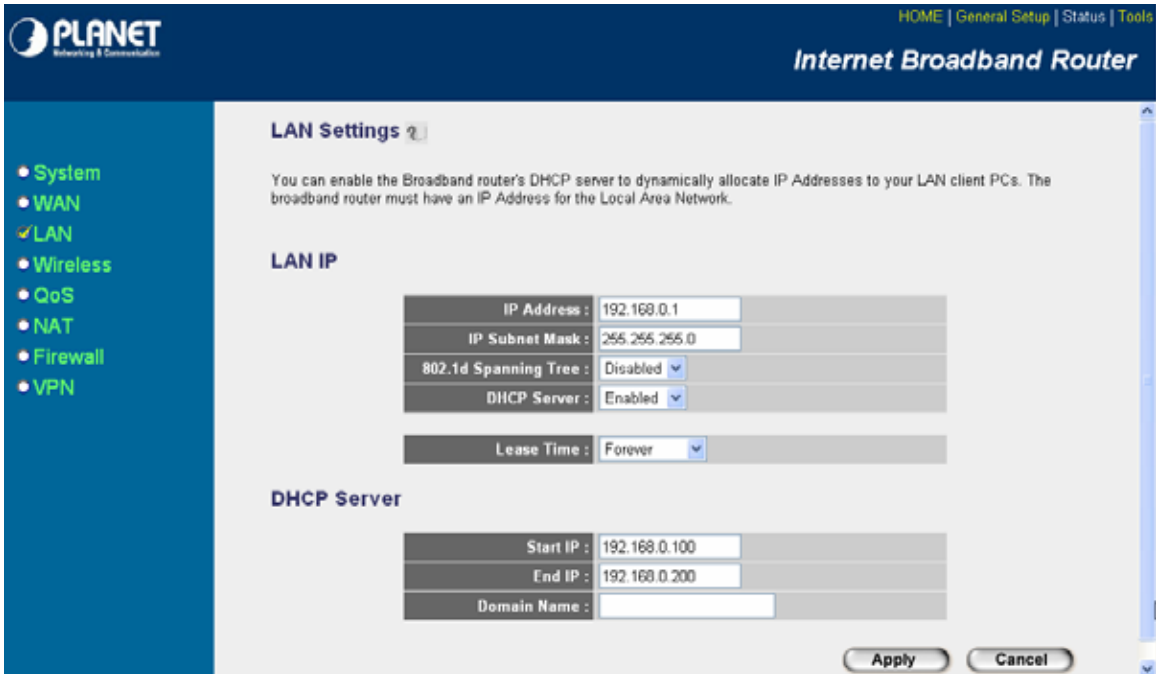

Parameters	Default	Description
LAN IP		
IP address	192.168.0.1	This is the router's LAN port IP address (Your LAN clients default gateway IP address)
IP Subnet Mask	255.255.255.0	Specify a Subnet Mask for your LAN segment
802.1d Spanning Tree	Disabled	If 802.1d Spanning Tree function is enabled, this router will use the spanning tree protocol to prevent from network loop happened in the LAN ports.
DHCP Server	Enabled	You can enable or disable the DHCP server. By enabling the DHCP server the router will automatically give your LAN clients an IP address. If the DHCP is not enabled then you'll have to manually set your LAN client's IP addresses; make sure the LAN Client is in the same subnet as VRT-401G, if you want the router to be your LAN client's default gateway.
Lease Time		The DHCP when enabled will temporarily give your LAN clients an IP address. In the Lease Time setting you can specify the time period that the DHCP lends an IP address to your LAN clients. The DHCP will change your LAN client's IP address when this time threshold period is reached.
IP Address Pool		You can select a particular IP address range for your DHCP server to issue IP addresses to your LAN Clients.

Note: By default the IP range is from: Start IP **192.168.0.100** to End IP **192.168.0.200**. If you want your PC to have a static/fixed IP address then you'll have to choose an IP address outside this IP address Pool.

Domain Name You can specify a Domain Name for your LAN

Click **<Apply>** at the bottom of the screen to save the above configurations. You can now configure other advance sections or start using the router (with the advance settings in place)

2.4 Wireless

Wireless Access Point builds a wireless LAN and can let all PCs equipped with IEEE 802.11b or 801.11g wireless network adaptor connect to your Intranet. It supports WEP and WPA2 encryption to enhance the security of your wireless network.

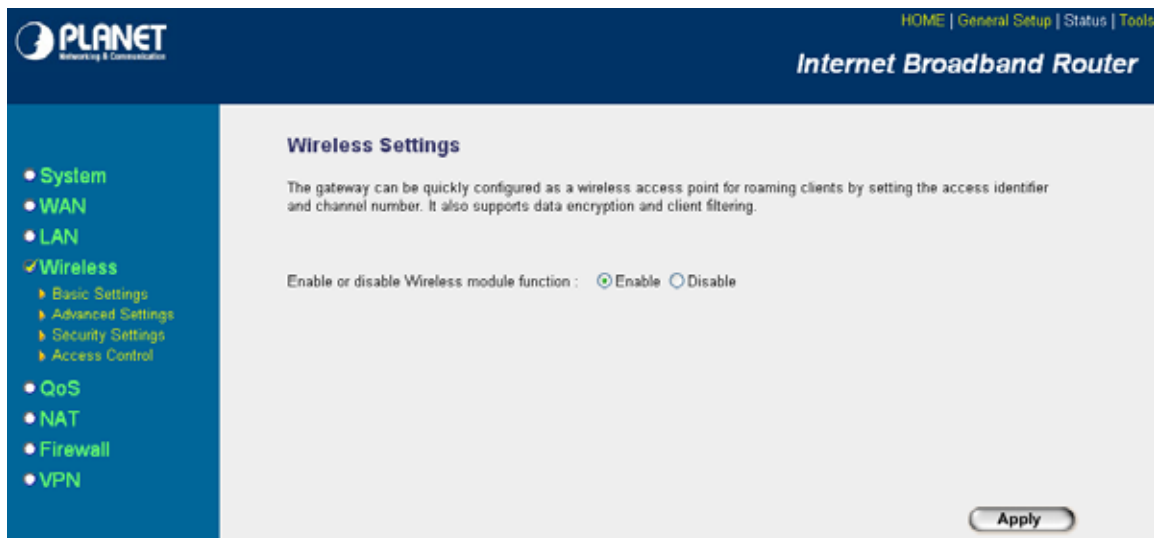

Parameters	Default	Description
Enable or disable Wireless module function	Enable	You can select to enable or disable the wireless access point module of this router.

Click **<Apply>** at the bottom of the screen to save the above configurations. You can now configure other advance sections or start using the router (with the advance settings in place)

2.4.1 Basic Settings

You can set parameters that are used for the wireless stations to connect to this router. The parameters include Mode, ESSID, Channel Number and Associated Client.

AP Mode setting Page:

PLANET
Networking & Communication

HOME | General Setup | Status | Tools

Internet Broadband Router

Wireless Setting

This page allows you to define ESSID, and Channel for the wireless connection. These parameters are used for the wireless stations to connect to the Access Point.

Mode :	AP
Band :	2.4 GHz (B+G)
ESSID :	default
Channel Number :	11
Associated Clients :	Show Active Clients

Apply Cancel

Station-Ad Hoc mode setting page:

PLANET
Networking & Communication

HOME | General Setup | Status | Tools

Internet Broadband Router

Wireless Setting

This page allows you to define ESSID, and Channel for the wireless connection. These parameters are used for the wireless stations to connect to the Access Point.

Mode :	Station-Ad Hoc
Band :	2.4 GHz (B+G)
ESSID :	default
Channel Number :	11
WLAN MAC :	000000000000 Clone MAC

Apply Cancel

Station-Infrastructure mode setting page:

PLANET
Networking & Communication

HOME | General Setup | Status | Tools

Internet Broadband Router

Wireless Setting

This page allows you to define ESSID, and Channel for the wireless connection. These parameters are used for the wireless stations to connect to the Access Point.

Mode :	Station-Infrastructure	
Band :	2.4 GHz (B+G)	
ESSID :	default	
WLAN MAC :	000000000000	Clone MAC

Apply Cancel

AP Bridge-Point to Point mode setting page:

PLANET
Networking & Communication

HOME | General Setup | Status | Tools

Internet Broadband Router

Wireless Setting

This page allows you to define ESSID, and Channel for the wireless connection. These parameters are used for the wireless stations to connect to the Access Point.

Mode :	AP Bridge-Point to Point
Band :	2.4 GHz (B+G)
Channel Number :	11
MAC Address 1 :	000000000000
Set Security :	Set Security

Apply Cancel

AP Bridge-Point to Multi-Point mode setting page:

PLANET
Networking & Communication

HOME | General Setup | Status | Tools

Internet Broadband Router

- System
- WAN
- LAN
- Wireless**
 - Basic Settings
 - Advanced Settings
 - Security Settings
 - Access Control
- QoS
- NAT
- Firewall
- VPN

Wireless Setting

This page allows you to define ESSID, and Channel for the wireless connection. These parameters are used for the wireless stations to connect to the Access Point.

Mode :	AP Bridge-Point to Multi-Point
Band :	2.4 GHz (B+G)
Channel Number :	11
MAC Address 1 :	000000000000
MAC Address 2 :	000000000000
MAC Address 3 :	000000000000
MAC Address 4 :	000000000000
MAC Address 5 :	000000000000
MAC Address 6 :	000000000000
Set Security :	Set Security

Apply Cancel

AP Bridge-WDS mode setting page:

PLANET
Networking & Communication

HOME | General Setup | Status | Tools

Internet Broadband Router

- System
- WAN
- LAN
- Wireless**
 - Basic Settings
 - Advanced Settings
 - Security Settings
 - Access Control
- QoS
- NAT
- Firewall
- VPN

Wireless Setting

This page allows you to define ESSID, and Channel for the wireless connection. These parameters are used for the wireless stations to connect to the Access Point.

Mode :	AP Bridge-WDS
Band :	2.4 GHz (B+G)
ESSID :	default
Channel Number :	11
Associated Clients :	Show Active Clients
MAC Address 1 :	000000000000
MAC Address 2 :	000000000000
MAC Address 3 :	000000000000
MAC Address 4 :	000000000000
MAC Address 5 :	000000000000
MAC Address 6 :	000000000000
Set Security :	Set Security

Apply Cancel

Parameters	Default	Description
Mode		It allows you to set the AP to AP, Station, Bridge or WDS mode.
Band		It allows you to set the AP fix at 802.11b or 802.11g mode. You also can select B+G mode to allow the AP select 802.11b and 802.11g connection automatically.
ESSID	default	This is the name of the wireless LAN. All the devices in the same wireless LAN should have the same ESSID.
Channel Number	11	The channel used by the wireless LAN. All devices in the same wireless LAN should use the same channel.
Associated Clients		Click "Show Active Clients" button, then an "Active Wireless Client Table" will pop up. You can see the status of all active wireless stations that are connecting to the access point.
WLAN MAC		This is the MAC address used by the Wireless interface of this AP when it is in the station modes.
Clone MAC		Click the "Clone MAC" button will copy the MAC address of your PC, that you are using to configure the AP, to the WLAN MAC.
MAC address		If you want to bridge more than one networks together with wireless LAN, you have to set this access point to "AP Bridge-Point to Point mode", "AP Bridge-Point to Multi-Point mode" or "AP Bridge-WDS mode". You have to enter the MAC addresses of other access points that join the bridging work.
Set Security		Click the "Set Security" button, then a "WDS Security Settings" will pop up. You can set the security parameters used to bridge access points together here when your AP is in AP Bridge modes. You can refer to section 4.3 "Security Settings" for how to set the parameters.

Click **<Apply>** at the bottom of the screen to save the above configurations. You can now configure other advance sections or start using the router (with the advance settings in place)

2.4.2 Advanced Settings

You can set advanced wireless LAN parameters of this router. The parameters include Authentication Type, Fragment Threshold, RTS Threshold, Beacon Interval, Preamble Type You should not change these parameters unless you know what effect the changes will have on this router.

PLANET
Networking & Communication

HOME | General Setup | Status | Tools

Internet Broadband Router

Advanced Settings

These settings are only for more technically advanced users who have a sufficient knowledge about wireless LAN. These settings should not be changed unless you know what effect the changes will have on your Broadband router.

Authentication Type :	<input type="radio"/> Open System	<input type="radio"/> Shared Key	<input checked="" type="radio"/> Auto
Fragment Threshold :	2346	(256-2346)	
RTS Threshold :	2347	(0-2347)	
Beacon Interval :	100	(20-1024 ms)	
Data Rate :	Auto		
Preamble Type :	<input checked="" type="radio"/> Long Preamble	<input type="radio"/> Short Preamble	
Broadcast ESSID :	<input checked="" type="radio"/> Enabled	<input type="radio"/> Disabled	
IAPP :	<input checked="" type="radio"/> Enabled	<input type="radio"/> Disabled	
802.11g Protection :	<input type="radio"/> Enabled	<input checked="" type="radio"/> Disabled	

Apply Cancel

Parameters	Description
Authentication Type	There are two authentication types: "Open System" and "Shared Key". When you select "Open System", wireless stations can associate with this wireless router without WEP encryption. When you select "Shared Key", you should also setup WEP key in the "Encryption" page and wireless stations should use WEP encryption in the authentication phase to associate with this wireless router. If you select "Auto", the wireless client can associate with this wireless router by using any one of these two authentication types.
Fragment Threshold	"Fragment Threshold" specifies the maximum size of packet during the fragmentation of data to be transmitted. If you set this value too low, it will result in bad performance.
RTS Threshold	When the packet size is smaller the RTS threshold, the wireless router will not use the RTS/CTS mechanism to send this packet.
Beacon Interval	The interval of time that this wireless router broadcast a beacon. Beacon is used to synchronize the wireless network.

Data Rate	The “Data Rate” is the rate this access point uses to transmit data packets. The access point will use the highest possible selected transmission rate to transmit the data packets.
Preamble Type	The “Long Preamble” can provide better wireless LAN compatibility while the “Short Preamble” can provide better wireless LAN performance.
Broadcast ESSID	If you enable “Broadcast ESSID”, every wireless station located within the coverage of this access point can discover this access point easily. If you are building a public wireless network, enabling this feature is recommended. Disabling “Broadcast ESSID” can provide better security.
IAPP	If you enable “IAPP”, it will allow wireless station roaming between IAPP enabled access points within the same wireless LAN.
802.11g Protection	This is also called CTS Protection. It is recommended to enable the protection mechanism. This mechanism can decrease the rate of data collision between 802.11b and 802.11g wireless stations. When the protection mode is enabled, the throughput of the AP will be a little lower due to many of frame traffic should be transmitted.

Click **<Apply>** at the bottom of the screen to save the above configurations. You can now configure other advance sections or start using the router.

2.4.3 Security

This Access Point provides complete wireless LAN security functions, include WEP, IEEE 802.11x, IEEE 802.11x with WEP, WPA with pre-shared key and WPA with RADIUS. With these security functions, you can prevent your wireless LAN from illegal access. Please make sure your wireless stations use the same security function.

2.4.3.1 WEP only

When you select 64-bit or 128-bit WEP key, you have to enter WEP keys to encrypt data. You can generate the key by yourself and enter it. You can enter four WEP keys and select one of them as default key. Then the router can receive any packets encrypted by one of the four keys

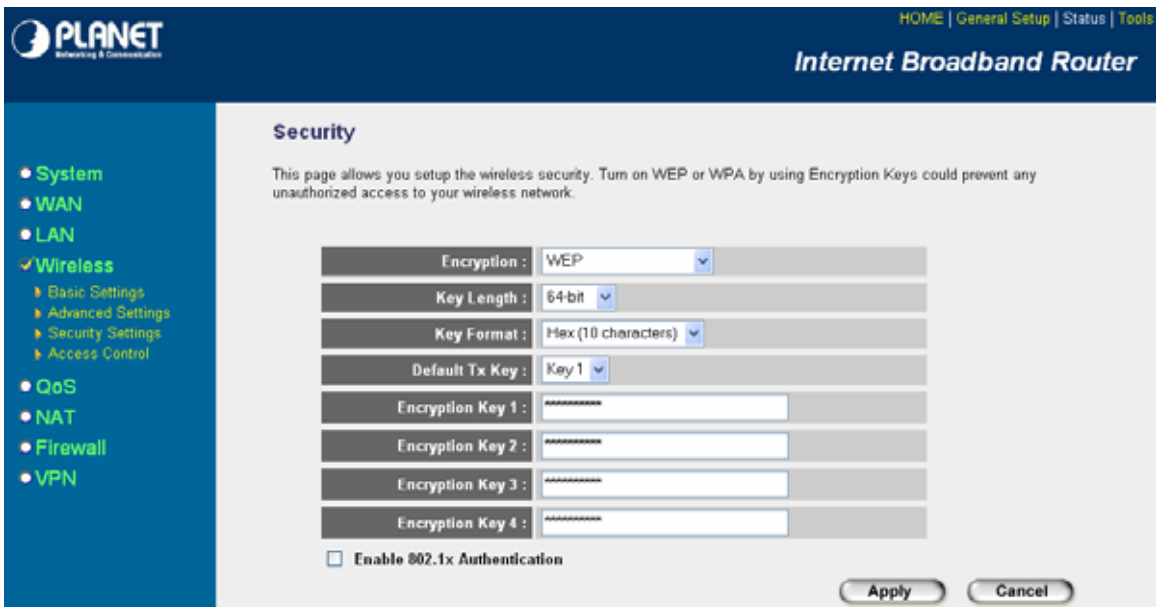

Parameters	Default	Description
Key Length	64-bit	You can select the WEP key length for encryption, 64-bit or 128-bit. Larger WEP key length will provide higher level of security, but the throughput will be lower.
Key Format		You may select to choose ASCII Characters (alphanumeric format) or Hexadecimal Digits (in the "A-F", "a-f" and "0-9" range) to be the WEP Key. For example: ASCII Characters: guest Hexadecimal Digits: 12345abcde
Default Key		Select one of the four keys to encrypt your data. Only the key you select it in the "Default key" will take effect.
Key 1 - Key 4		The WEP keys are used to encrypt data transmitted in the wireless network. Fill the text box by following the rules below. 64-bit WEP: input 10-digit Hex values (in the "A-F", "a-f" and "0-9" range) or 5-digit ASCII character as the encryption keys. 128-bit WEP: input 26-digit Hex values (in the "A-F", "a-f" and "0-9" range) or 13-digit ASCII characters as the encryption keys.

Click **<Apply>** at the bottom of the screen to save the above configurations. You can now configure other advance sections or start using the router (with the advance settings in place)

2.4.3.2 802.1x only

IEEE 802.1x is an authentication protocol. Every user must use a valid account to login to this Access Point before accessing the wireless LAN. The authentication is processed by a RADIUS server. This mode only authenticates user by IEEE 802.1x, but it does not encryption the data during communication.

The screenshot shows the configuration interface for the Planet Internet Broadband Router. The page is titled "Security" and includes a navigation menu on the left with options like System, WAN, LAN, Wireless, QoS, NAT, and Firewall. The main content area contains the following settings:

- Encryption: Disable (dropdown menu)
- Enable 802.1x Authentication
- RADIUS Server IP address: [Empty text box]
- RADIUS Server Port: 1812 (text box)
- RADIUS Server Password: [Empty text box]

Buttons for "Apply" and "Cancel" are located at the bottom right of the configuration area.

Parameters	Default	Description
RADIUS Server IP address		The IP address of external RADIUS server.
RADIUS Server Port		The service port of the external RADIUS server.
RADIUS Server Password		The password used by external RADIUS server.

Click **<Apply>** at the bottom of the screen to save the above configurations. You can now configure other advance sections or start using the router (with the advance settings in place)

2.4.3.3 802.1x WEP Static key

IEEE 802.1x is an authentication protocol. Every user must use a valid account to login to this Access Point before accessing the wireless LAN. The authentication is processed by a RADIUS server. This mode also uses WEP to encrypt the data during communication.

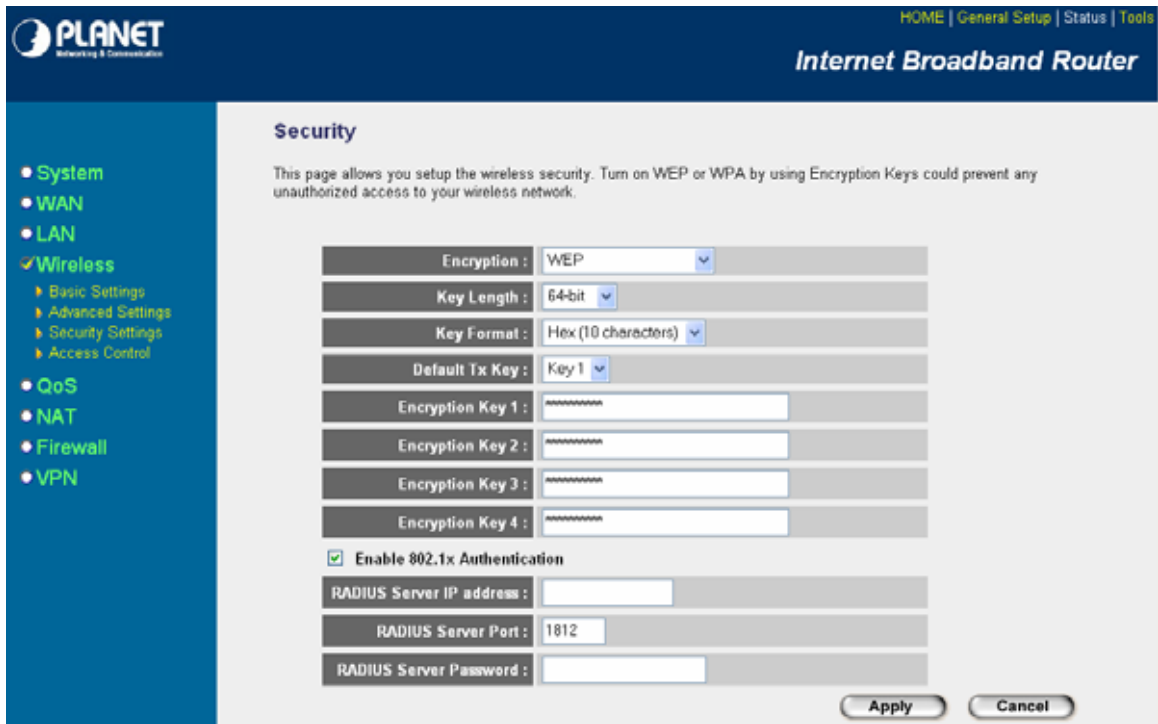

For the WEP settings, please refer to section 2.4.3.1 “WEP only”. For the 802.1x settings, please refer to section 2.4.3.2 “802.1x only”.

2.4.3.4 WPA Pre-shared key

Wi-Fi Protected Access (WPA) is an advanced security standard. You can use a pre-shared key to authenticate wireless stations and encrypt data during communication. It uses TKIP or CCMP (AES) to change the encryption key frequently. So the encryption key is not easy to be broken by hackers. This can improve security very much.

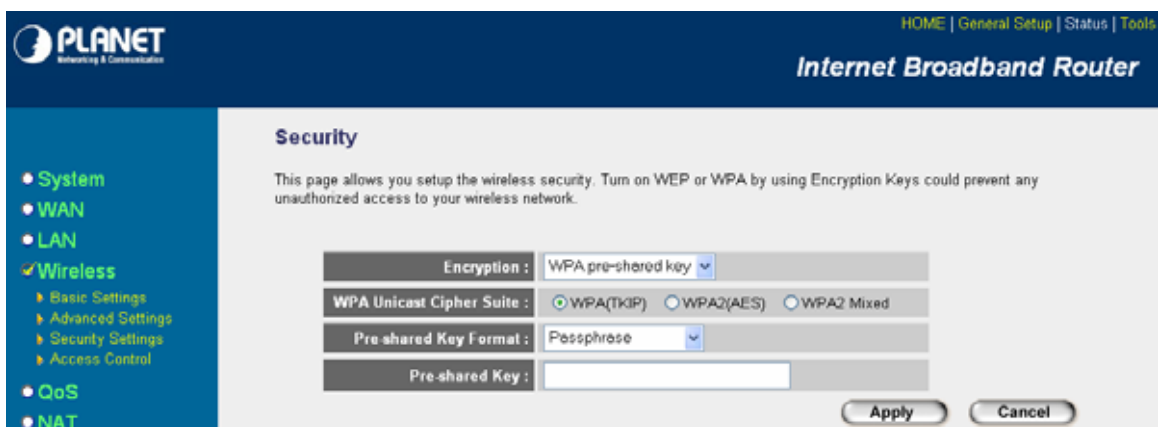

Parameters	Default	Description
WPA(TKIP)		TKIP can change the encryption key frequently to enhance the wireless LAN security.

WPA2(AES)	This use CCMP protocol to change encryption key frequently. AES can provide high level encryption to enhance the wireless LAN security.
WPA2 Mixed	This will use TKIP or AES based on the other communication peer automatically.
Pre-shared Key Format	You may select to select Passphrase (alphanumeric format) or Hexadecimal Digits (in the "A-F", "a-f" and "0-9" range) to be the Pre-shared Key. For example: Passphrase: iamguest Hexadecimal Digits: 12345abcde
Pre-shared Key	The Pre-shared key is used to authenticate and encrypt data transmitted in the wireless network. Fill the text box by following the rules below. Hex WEP: input 64-digit Hex values (in the "A-F", "a-f" and "0-9" range) or at least 8 character pass phrase as the pre-shared keys.

Click **<Apply>** at the bottom of the screen to save the above configurations. You can now configure other advance sections or start using the router (with the advance settings in place)

2.4.3.5 WPA Radius

Wi-Fi Protected Access (WPA) is an advanced security standard. You can use an external RADIUS server to authenticate wireless stations and provide the session key to encrypt data during communication. It uses TKIP or CCMP (AES) to change the encryption key frequently. This can improve security very much.

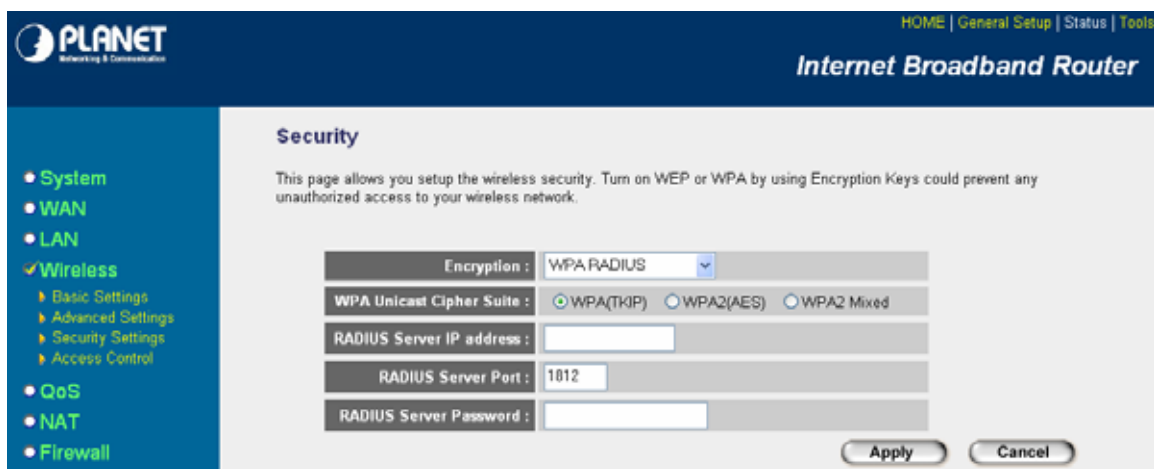

Parameters	Default	Description
WPA(TKIP)		TKIP can change the encryption key frequently to enhance the wireless LAN security.

WPA2(AES)	This use CCMP protocol to change encryption key frequently. AES can provide high level encryption to enhance the wireless LAN security.
WPA2 Mixed	This will use TKIP or AES based on the other communication peer automatically.
RADIUS Server IP address	The IP address of external RADIUS server.
RADIUS Server Port	The service port of the external RADIUS server.
RADIUS Server Password	The password used by external RADIUS server.

Click **<Apply>** at the bottom of the screen to save the above configurations. You can now configure other advance sections or start using the router (with the advance settings in place)

2.4.4 Access Control

This wireless router provides MAC Address Control, which prevents the unauthorized MAC Addresses from accessing your wireless network.



Parameters	Description
Enable wireless access control	Enable wireless access control
Add MAC address into the list	Fill in the "MAC Address" and "Comment" of the wireless station to be added and then click "Add". Then this wireless station will be added into the "Current Access Control List" below. If you find any issues before adding it and want to retype again. Just click "Clear" and both "MAC Address" and "Comment" fields will be cleared.

Remove MAC address from the list

If you want to remove some MAC address from the "Current Access Control List ", select the MAC addresses you want to remove in the list and then click "Delete Selected". If you want remove all MAC addresses from the table, just click "Delete All" button. Click "Reset" will clear your current selections.

Click **<Apply>** at the bottom of the screen to save the above configurations. You can now configure other advance sections or start using the router (with the advance settings in place)

2.5 QoS

The QoS can let you classify Internet application traffic by source/destination IP address and port number. You can assign priority for each type of application and reserve bandwidth for it. The packets of applications with higher priority will always go first. Lower priority applications will get bandwidth after higher priority applications get enough bandwidth. This can let you have a better experience in using critical real time services like Internet phone, video conference ...etc. All the applications not specified by you are classified as rule name "Others". The rule with smaller priority number has higher priority; the rule with larger priority number has lower priority. You can adjust the priority of the rules by moving them up or down.

Note: If the total assigned bandwidth of higher priority applications is larger than the maximum bandwidth provided by the WAN port, the other applications will not get any bandwidth.

PLANET
Networking & Communications

HOME | General Setup | Status | Tools

Internet Broadband Router

QoS

Quality of Service (QoS) refers to the capability of a network to provide better service to selected network traffic. The primary goal of QoS is to provide priority including dedicated bandwidth, controlled jitter and latency (required by some real-time and interactive traffic), and improved loss characteristics. Also important is making sure that providing priority for one or more flows does not make other flows fail.

Enable QoS

Current QoS Table:

Priority	Rule Name	Upload Bandwidth	Download Bandwidth	Select
----------	-----------	------------------	--------------------	--------

Add Edit Delete Selected Delete All Move Up Move Down Reset

Apply Cancel

Parameters	Description
Enable/Disable QoS	You can check "Enable QoS" to enable QoS function for the WAN port. You also can uncheck "Enable QoS" to disable QoS function for the WAN port.

Add a QoS rule into the table

Click "Add" then you will enter a form of the QoS rule. Click "Apply" after filling out the form and the rule will be added into the table.

Remove QoS rules from the table

If you want to remove some QoS rules from the table, select the QoS rules you want to remove in the table and then click "Delete Selected". If you want remove all QoS rules from the table, just click "Delete All" button. Click "Reset" will clear your current selections.

Edit a QoS rule

Select the rule you want to edit and click "Edit", then you will enter the detail form of the QoS rule. Click "Apply" after editing the form and the rule will be saved.

Adjust QoS rule priority

You can select the rule and click "Move Up" to make its priority higher. You also can select the rule and click "Move Down" to make its priority lower.

Edit QoS Rule:

You can assign packet classification criteria by its local IP range, remote IP range, traffic type, protocol, local port range and remote port range parameters. The parameters that you leave as blank will be ignored. The priority of this rule will be applied to packets that match classification criteria of this rule. You can limit bandwidth consumed by packets that match this rule or guarantee bandwidth required by packets that match this rule.

PLANET
Networking & Communications

HOME | General Setup | Status | Tools

Internet Broadband Router

QoS

This page allows users to add/modify the QoS rule's settings.

Rule Name :	<input type="text"/>
Bandwidth :	Download <input type="text"/> Kbps Guarantee <input type="text"/>
Local IP Address :	<input type="text"/>
Local Port Range :	<input type="text"/>
Remote IP Address :	<input type="text"/>
Remote Port Range :	<input type="text"/>
Traffic Type :	None <input type="text"/>
Protocol :	TCP <input type="text"/>

Save Reset

Parameters	Description
Rule Name	The name of this rule.

Bandwidth	You can assign the download or upload bandwidth by the unit of Kbps (1024 bit per second). You can limit the maximum bandwidth consumed by this rule by selecting "Maximum". You also can reserve enough bandwidth for this rule by selecting "Guarantee".
Local IP Address	Enter the local IP address range of the packets that this rule will apply to. If you assign 192.168.2.3 – 192.168.2.5, it means 3 IP addresses: 192.168.2.3, 192.168.2.4 and 192.168.2.5
Local Port Range	Enter the local port range of the packets that this rule will apply to. You can assign a single port number here or assign a range of port numbers by assigning the first port number and the last port number of the range. The two numbers are separated by a dash "-", for example "101-150" means from port number 100 to port number 150 – the range of 50 port numbers.
Remote IP Address	Enter the remote IP address range of the packets that this rule will apply to. If you assign 192.168.2.3 – 192.168.2.5, it means 3 IP addresses: 192.168.2.3, 192.168.2.4 and 192.168.2.5
Remote Port Range	Enter the remote port range of the packets that this rule will apply to. You can assign a single port number here or assign a range of port numbers by assigning the first port number and the last port number of the range. The two numbers are separated by a dash "-", for example "101-150" means from port number 100 to port number 150 – the range of 50 port numbers.
Traffic Type	Select the traffic type of the packets that this rule will apply to. We list some popular applications here to ease the configuration. You also can get the same result by using other parameters, for example source or destination port number, if you are familiar with the application protocol.
Protocol	Select the protocol type of the packets that this rule will apply to.
Save	Save and exit the form.
Reset	Clear the content of this form.

Click **<Apply>** at the bottom of the screen to save the above configurations. You can now configure other advance sections or start using the router (with the advance settings in place)

2.6 NAT

Network Address Translation (NAT) allows multiple users at your local site to access the Internet through a single Public IP Address or multiple Public IP Addresses. NAT provides Firewall protection from hacker attacks and has the flexibility to allow you to map Private IP Addresses to Public IP Addresses for key services such as Websites and FTP.

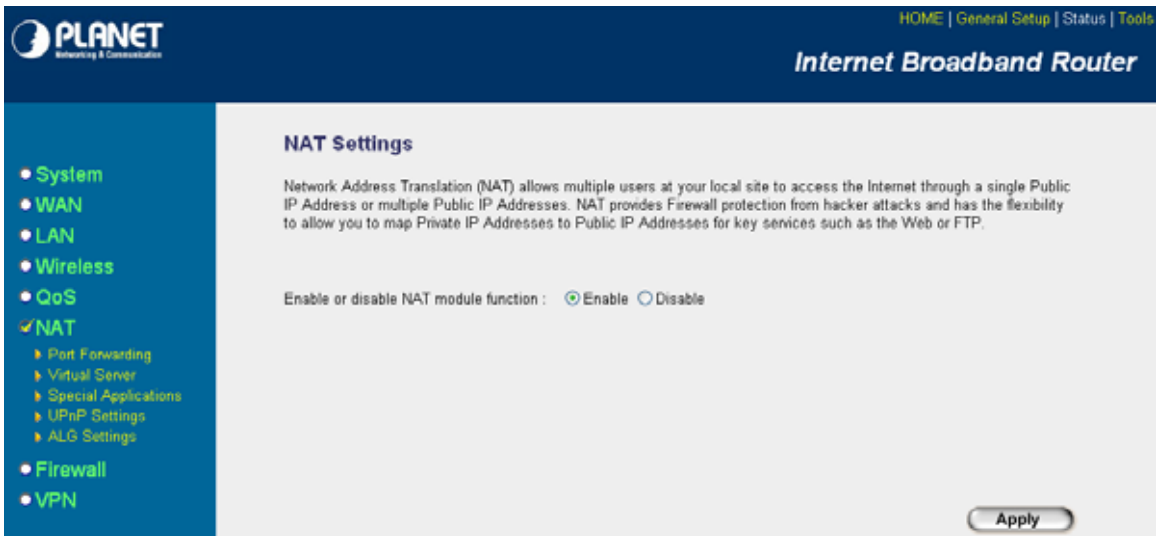

Parameter	Description
2.6.1 Port Forwarding	You can have different services (e.g. email, FTP, Web etc.) going to different service servers/clients in your LAN. The Port Forwarding allows you to re-direct a particular range of service port numbers (from the Internet/WAN Ports) to a particular LAN IP address.
2.6.2 Virtual Server	You can have different services (e.g. email, FTP, Web etc.) going to different service servers/clients in your LAN. The Virtual Server allows you to re-direct a particular service port number (from the Internet/WAN Port) to a particular LAN IP address and its service port number.
2.6.3 Special Applications	Some applications require multiple connections, such as Internet games, video conferencing, Internet telephony and others. In this section you can configure the router to support these types of applications.
2.6.4 UPnP Setting	It allows to Enable or Disable UPnP feature here. After you enable the UPnP feature, all client systems that support UPnP, like Windows XP, can discover this router automatically and access the Internet through this router without any configuration. The NAT Traversal function provided by UPnP can let applications that support UPnP smoothly connect to Internet sites without any incompatibility problem due to the NAT port translation.
2.6.5 ALG Setting	You can select special applications that need "Application Layer Gateway" to support here.
2.6.6 Static Routing	You can disable NAT function and setup the routing rules manually.

Click on one of the three NAT selections and proceed to the manual's relevant sub-section.

2.6.1 Port Forwarding

The Port Forwarding allows you to re-direct a particular range of service port numbers (from the Internet/WAN Ports) to a particular LAN IP address. It helps you to host some servers behind the router NAT firewall.

Parameter	Description
Enable Port Forwarding	Enable Port Forwarding
Private IP	This is the private IP of the server behind the NAT firewall. Note: You need to give your LAN PC clients a fixed/static IP address for Port Forwarding to work properly.
Type	This is the protocol type to be forwarded. You can choose to forward “TCP” or “UDP” packets only or select “both” to forward both “TCP” and “UDP” packets.
Port Range	The range of ports to be forward to the private IP.
Comment	The description of this setting.

Click <**Apply**> at the bottom of the screen to save the above configurations. You can now configure other advance sections or start using the router (with the advance settings in place)

2.6.2 Virtual Server

Use the Virtual Server function when you want different servers/clients in your LAN to handle different service/Internet application type (e.g. Email, FTP, Web server etc.) from the Internet.

Computers use numbers called port numbers to recognize a particular service/Internet application type. The Virtual Server allows you to re-direct a particular service port number (from the Internet/WAN Port) to a particular LAN private IP address and its service port number. (See Glossary for an explanation on Port number)

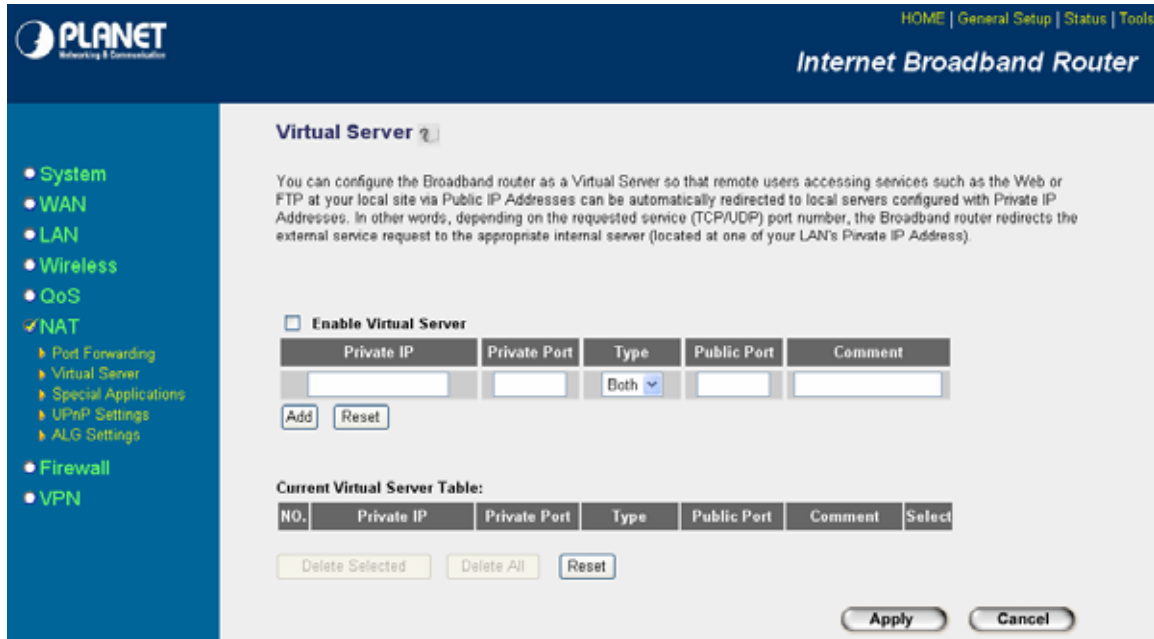

Parameters	Description
Enable Virtual Server	Enable Virtual Server.
Private IP	This is the LAN client/host IP address that the Public Port number packet will be sent to. Note: You need to give your LAN PC clients a fixed/static IP address for Virtual Server to work properly.
Private Port	This is the port number (of the above Private IP host) that the below Public Port number will be changed to when the packet enters your LAN (to the LAN Server/Client IP)
Type	Select the port number protocol type (TCP, UDP or both). If you are unsure, then leave it to the default both protocols.
Public Port	Enter the service (service/Internet application) port number from the Internet that will be re-directed to the above Private IP address host in your LAN Note: Virtual Server function will have priority over the DMZ function if there is a conflict between the Virtual Server and the DMZ settings.
Comment	The description of this setting.
Add Virtual Server	Fill in the "Private IP", "Private Port", "Type", "Public Port" and "Comment" of the setting to be added and then click "Add", the Virtual Server setting will be added into the "Current Virtual

Server Table" below. If you find any typo before adding it and want to change the setting, just click "Clear" and retype it again..

Remove Virtual Server

If you want to remove some Virtual Server settings from the "Current Virtual Server Table", select the Virtual Server settings you want to remove in the table and then click "Delete Selected". If you want remove all Virtual Server settings from the table, just click "Delete All" button. Click "Reset" will clear your current selections.

Click **<Apply>** at the bottom of the screen to save the above configurations. You can now configure other advance sections or start using the router (with the advance settings in place)

Example: Virtual Server

The diagram below demonstrates one of the ways you can use the Virtual Server function. Use the Virtual Server when you want the web server located in your private LAN to be accessible to Internet users. The configuration below means that any request coming form the Internet to access your web server will be translated to your LAN's web server (192.168.2.2). **Note:** For the virtual server to work properly Internet/remote users must know your global IP address. (For websites you will need to have a fixed/static global/public IP address)

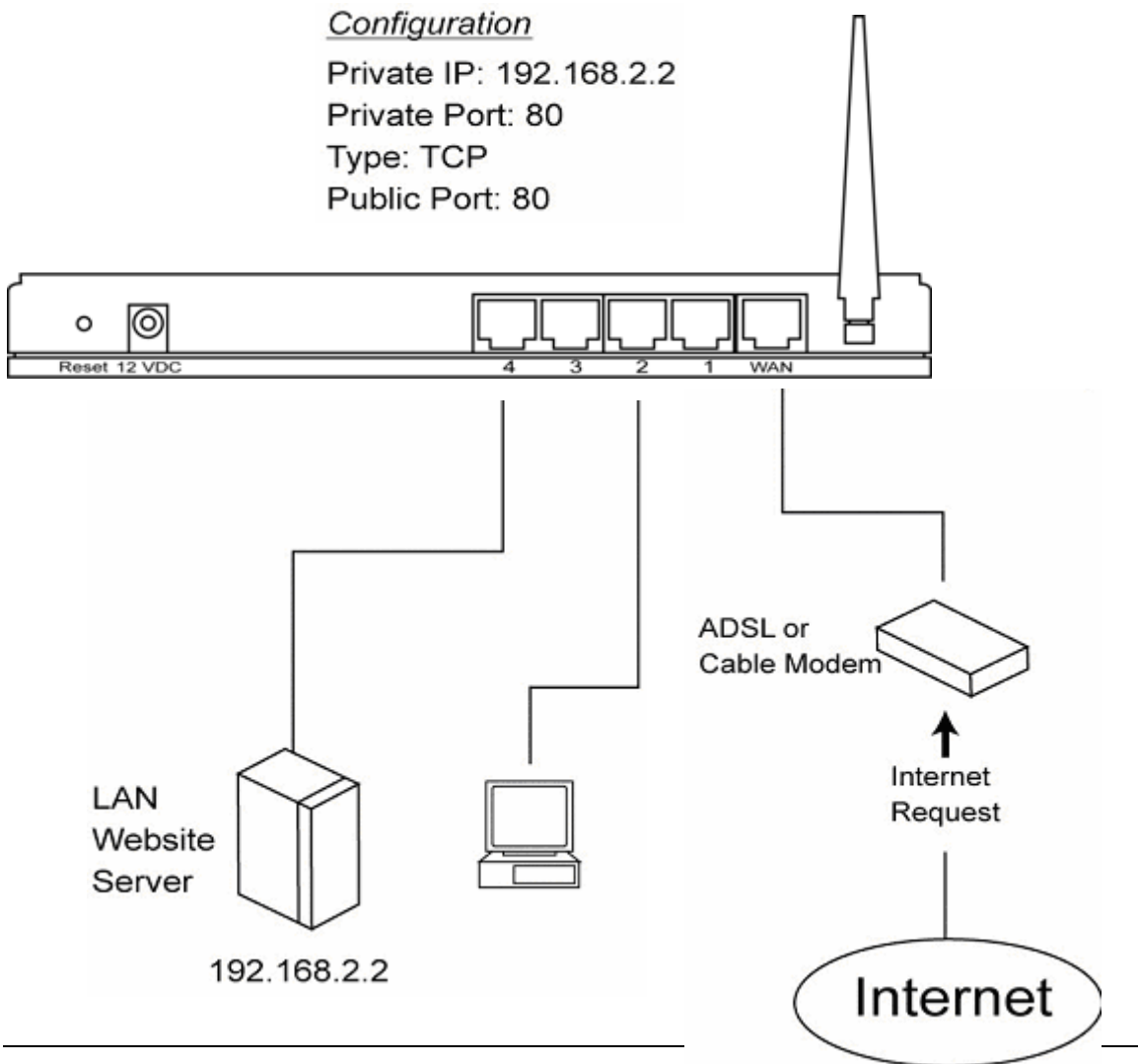

2.6.3 Special Applications

Some applications require multiple connections, such as Internet games, video conferencing, Internet telephony and others. In this section you can configure the router to support multiple connections for these types of applications.

Parameters	Description
Enable Trigger Port	Enable the Special Application function.
Trigger Port	This is the out going (Outbound) range of port numbers for this particular application
Trigger Type	Select whether the outbound port protocol is “TCP”, “UDP” or both.
Public Port	Enter the In-coming (Inbound) port or port range for this type of application (e.g. 2300-2400, 47624) Note: Individual port numbers are separated by a comma (e.g. 47624, 5775, 6541 etc.). To input a port range use a “dash” to separate the two port number range (e.g. 2300-2400)
Public Type	Select the Inbound port protocol type: “TCP”, “UDP” or both
Comment	The description of this setting.
Popular applications	This section lists the more popular applications that require multiple connections. Select an application from the Popular Applications selection. Once you have selected an application, select a location (1-10) in the Copy to selection box and then click the Copy to button. This will automatically list the Public

Ports required for this popular application in the location (1-10) you'd specified.

Add Special Application

Fill in the "Trigger Port", "Trigger Type", "Public Port", "Public Type", "Public Port" and "Comment" of the setting to be added and then click "Add". Then this Special Application setting will be added into the "Current Trigger-Port Table" below. If you find any typo before adding it and want to retype again, just click "Clear" and the fields will be cleared.

If you want to add a popular application, select one "Popular Application" and then click "Add".

Remove Special Application

If you want to remove some Special Application settings from the "Current Trigger-Port Table", select the Special Application settings you want to remove in the table and then click "Delete Selected". If you want remove all Special Application settings from the table, just click "Delete All" button. Click "Reset" will clear your current selections.

Click **<Apply>** at the bottom of the screen to save the above configurations. You can now configure other advance sections or start using the router (with the advance settings in place)

Example: Special Applications

If you need to run applications that require multiple connections, then specify the port (outbound) normally associated with that application in the "Trigger Port" field. Then select the protocol type (TCP or UDP) and enter the public ports associated with the trigger port to open them up for inbound traffic.

Example:

ID	Trigger Port	Trigger Type	Public Port	Public Type	Comment
1	28800	UDP	2300-2400, 47624	TCP	MSN Game Zone
2	6112	UDP	6112	UDP	Battle.net

In the example above, when a user trigger's port 28800 (outbound) for MSN Game Zone then the router will allow incoming packets for ports 2300-2400 and 47624 to be directed to that user.

Note: Only one LAN client can use a particular special application at a time.

2.6.4 UPnP Settings

With UPnP, all PCs in you Intranet will discover this router automatically. So you do not have to do any configuration for your PC and can access the Internet through this router easily.

PLANET
Networking & Communication

HOME | General Setup | Status | Tools

Internet Broadband Router

- System
- WAN
- LAN
- Wireless
- QoS
- NAT
 - Port Forwarding
 - Virtual Server
 - Special Applications
 - UPnP Settings
 - ALG Settings
- Firewall
- VPN

UPnP

UPnP is more than just a simple extension of the Plug and Play peripheral model. It is designed to support zero-configuration, "invisible" networking, and automatic discovery for a breadth of device categories from a wide range of vendors.

With UPnP, a device can dynamically join a network, obtain an IP address, convey its capabilities, and learn about the presence and capabilities of other devices-all automatically, truly enabling zero configuration networks. Devices can subsequently communicate with each other directly, thereby further enabling peer to peer networking

UPnP Feature : ENABLE DISABLE

Apply Cancel

Parameters	Default	Description
UPnP Feature	Disable	You can Enable or Disable UPnP feature here. After you enable the UPnP feature, all client systems that support UPnP, like Windows XP, can discover this router automatically and access the Internet through this router without any configuration. The NAT Traversal function provided by UPnP can let applications that support UPnP smoothly connect to Internet sites without any incompatibility problem due to the NAPT port translation.

Click **<Apply>** at the bottom of the screen to save the above configurations. You can now configure other advance sections or start using the router (with the advance settings in place)

2.6.5 ALG Settings

You can select applications that need "Application Layer Gateway" to support.

HOME | General Setup | Status | Tools

Internet Broadband Router

- System
- WAN
- LAN
- Wireless
- QoS
- ✓ NAT
 - ▶ Port Forwarding
 - ▶ Virtual Server
 - ▶ Special Applications
 - ▶ UPnP Settings
 - ▶ ALG Settings
- Firewall
- VPN

Application Layer Gateway ?

Below are applications that need router's special support to make them work under the NAT. You can select applications that you are using.

Enable	Name	Comment
<input checked="" type="checkbox"/>	Amanda	Support for Amanda backup tool protocol.
<input checked="" type="checkbox"/>	Egg	Support for eggdrop bot networks.
<input checked="" type="checkbox"/>	FTP	Support for FTP.
<input checked="" type="checkbox"/>	H323	Support for H323/netmeeting.
<input checked="" type="checkbox"/>	IRC	Allows DCC to work though NAT and connection tracking.
<input checked="" type="checkbox"/>	MMS	Support for Microsoft Streaming Media Services protocol.
<input checked="" type="checkbox"/>	Quake3	Support for Quake III Arena connection tracking and nat.
<input checked="" type="checkbox"/>	Talk	Allows netfilter to track talk connections.
<input checked="" type="checkbox"/>	TFTP	Support for TFTP.
<input checked="" type="checkbox"/>	Starcraft	Support for Starcraft/Battle.net game protocol.
<input checked="" type="checkbox"/>	MSN	Support for MSN file transfer.

Parameters	Default	Description
Enable		You can select to enable "Application Layer Gateway", then the router will let that application correctly pass though the NAT gateway.

Click **<Apply>** at the bottom of the screen to save the above configurations. You can now configure other advance sections or start using the router (with the advance settings in place)

2.6.6 Static Routing

This router provides Static Routing function when NAT is disabled. With Static Routing, the router can forward packets according to your routing rules. The IP sharing function will not work any more in Static Routing mode.

Note: The DMZ function of firewall will not work if static routing is enabled.

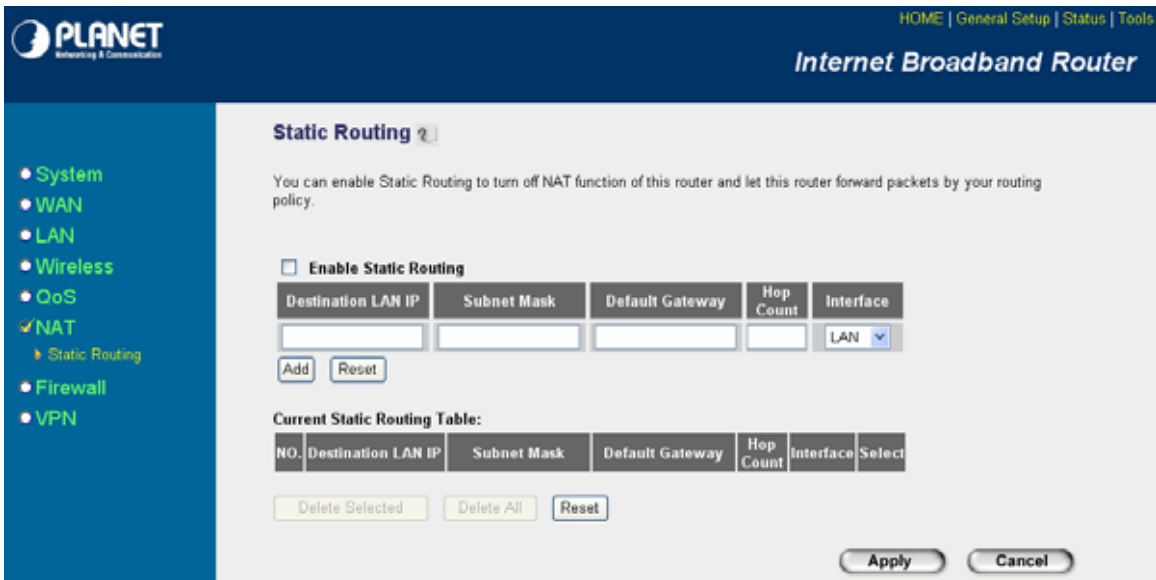

Parameter	Description
Enable Static Routing	Static Routing function is default disabled. You have to enable the Static Routing function before your routing rules take effect.
Destination LAN IP	The network address of destination LAN.
Subnet Mask	The subnet mask of destination LAN.
Default Gateway	The next stop gateway of the path toward the destination LAN. This is the IP of the neighbor router that this router should communicate with on the path to the destination LAN.
Hop Count	The number of hops (routers) to pass through to reach the destination LAN.
Interface	The interface that go to the next hop (router).
Add a Rule	Fill in the "Destination LAN IP", "Subnet Mask", "Default Gateway", "Hop Count" and "Interface" of the rule to be added and then click "Add". Then this rule of Static Routing will be added into the "Static Routing Table" below. If you find any typo before adding it and want to retype again, just click "Reset" and the fields will be cleared.
Remove a Rule	If you want to remove some routing rules from the "Static Routing Table", select the rules you want to remove in the table and then click "Delete Selected". If you want remove all rules from the table, just click "Delete All" button. Click "Reset" will clear your current selections.

Click **<Apply>** at the bottom of the screen to save the above configurations. You can now configure other advance sections or start using the router (with the advance settings in place)

2.7 Firewall

The VRT-401G provides extensive firewall protection by restricting connection parameters, thus limiting the risk of hacker attack, and defending against a wide array of common Internet attacks. However, for applications that require unrestricted access to the Internet, you can configure a specific client/server as a Demilitarized Zone (DMZ).

Note: To enable the Firewall settings select **Enable** and click **Apply**

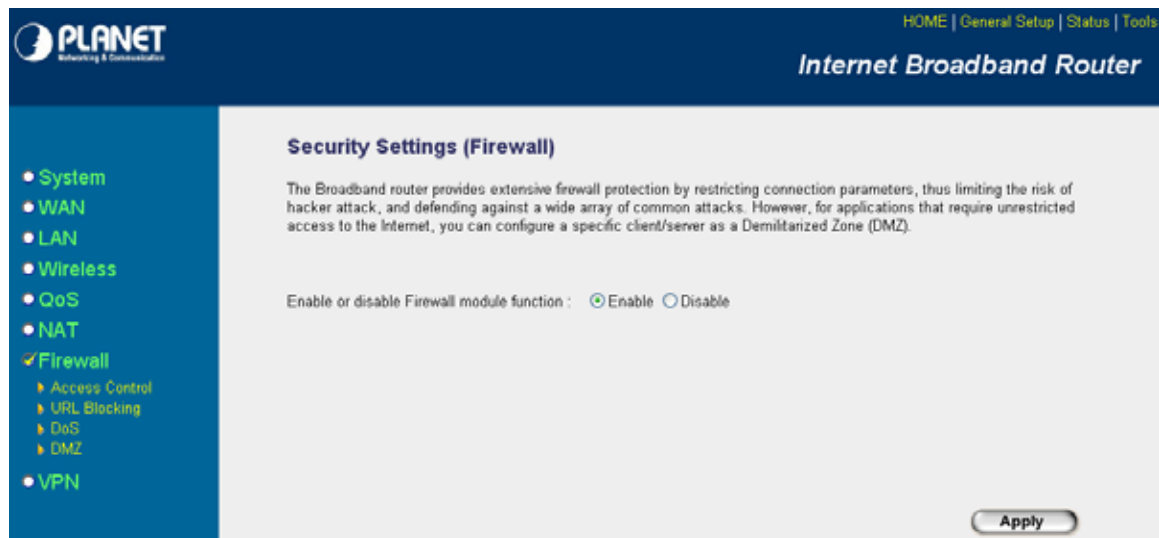

Parameters	Description
2.7.1 Access Control	Access Control allows you to specify which hosts users can or cannot have access to certain Internet applications
2.7.2 URL Blocking	URL Blocking allows you to specify which URLs can not be accessed by users.
2.7.3 DoS	The VRT-401G's firewall can block common hacker attacks and can log the attack activities.
2.7.4 DMZ	The DMZ function allows you to re-direct all packets going to your WAN port IP address to a particular IP address in your LAN.

Click on one of the firewall selections and proceed to the manual's relevant sub-section

2.7.1 Access Control

If you want to restrict users from accessing certain Internet applications/services (e.g. Internet websites, email, FTP etc.), then this is the place to set that configuration. Access Control allows

users to define the traffic type permitted in your LAN. You can control which PC client can have access to these services.

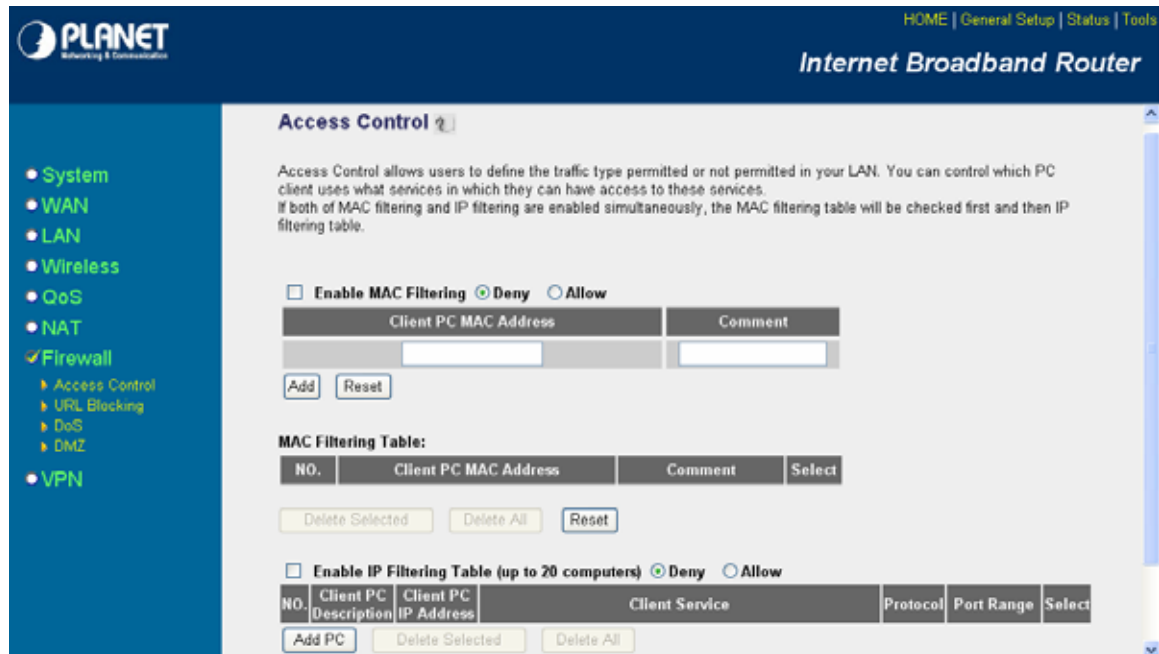

Parameters	Description
Deny	If select "Deny" then all PCs will be allowed to access Internet accept for the PCs in the list below.
Allow	If select "Allow" then all PCs will be denied to access Internet accept for the PCs in the list below.
Filter client PC by MAC address	Check "Enable MAC Filtering" to enable MAC Filtering.
Add PC	Fill in "Client PC MAC Address" and "Comment" of the PC that is allowed to access the Internet, and then click "Add". If you find any typo before adding it and want to retype again, just click "Reset" and the fields will be cleared.
Remove PC	If you want to remove some PC from the "MAC Filtering Table", select the PC you want to remove in the table and then click "Delete Selected". If you want remove all PCs from the table, just click "Delete All" button. If you want to clear the selection and re-select again, just click "Reset".
Filter client PCs by IP	Fill "IP Filtering Table" to filter PC clients by IP.
Add PC	You can click Add PC to add an access control rule for users by IP addresses.
Remove PC	If you want to remove some PC from the "IP Filtering Table", select the PC you want to remove in the table

and then click "Delete Selected". If you want remove all PCs from the table, just click "Delete All" button.

You can now configure other advance sections or start using the router (with the advance settings in place)

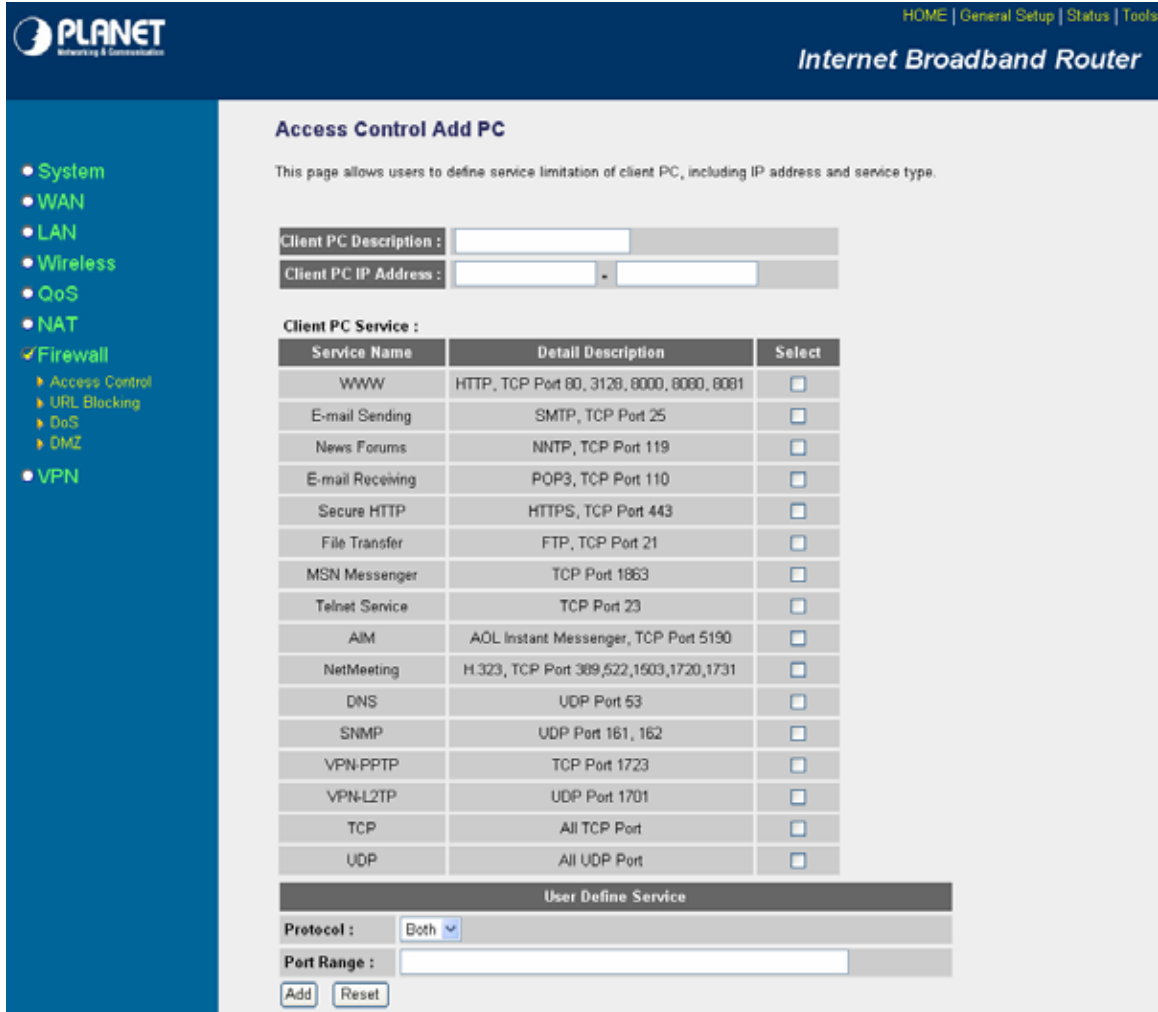

Add PC

Parameters	Description
Client PC Description	The description for this client PC rule.
Client PC IP Addresses	Enter the IP address range that you wish to apply this Access Control rule. This is the user's IP address(es) that you wish to setup an Access Control rule. Note: You need to give your LAN PC clients a fixed/static IP address for the Access Control rule to work properly.
Client PC Service	You can block the clients from accessing some Internet services by checking the services you want to block.

Protocol	This allows you to select UDP, TCP or both protocol types you want to block.
Port Range	It can be assigned up to five port ranges. The router will block clients from accessing Internet services that use these ports.
Apply Changes	Click "Apply Changes" to save the setting.
Reset	Click "Reset" to clear all fields.

Click **<Apply Changes>** at the bottom of the screen to save the above configurations. You can now configure other advance sections or start using the router (with the advance settings in place)

Example: Access Control

In the example below, LAN client A can only access websites that use Port 80. However, LAN client B is able to access websites and any other service that uses ports between 80 and 999.

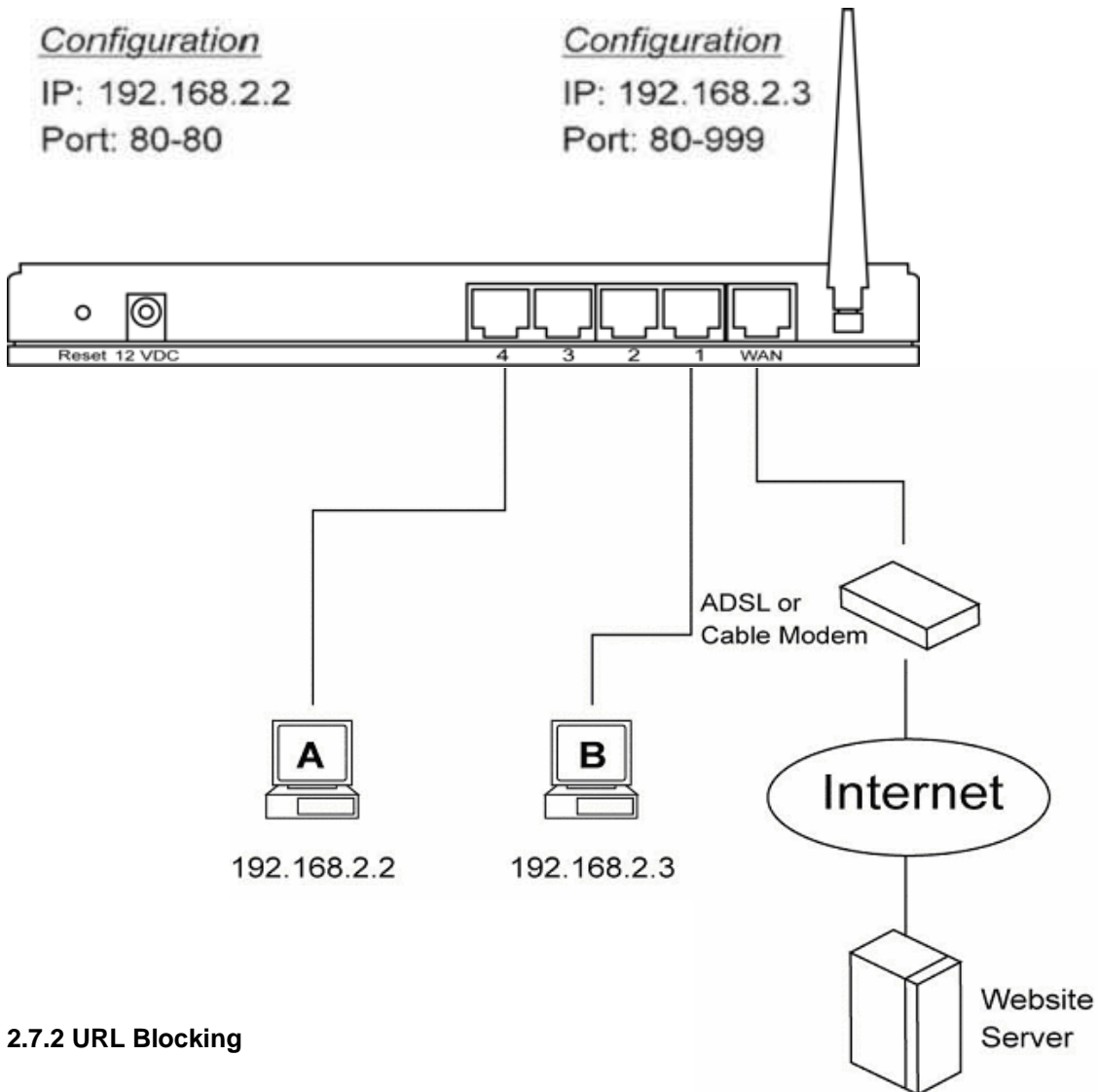

2.7.2 URL Blocking

You can block access to some Web sites from particular PCs by entering a full URL address or just keyword of the Web site.

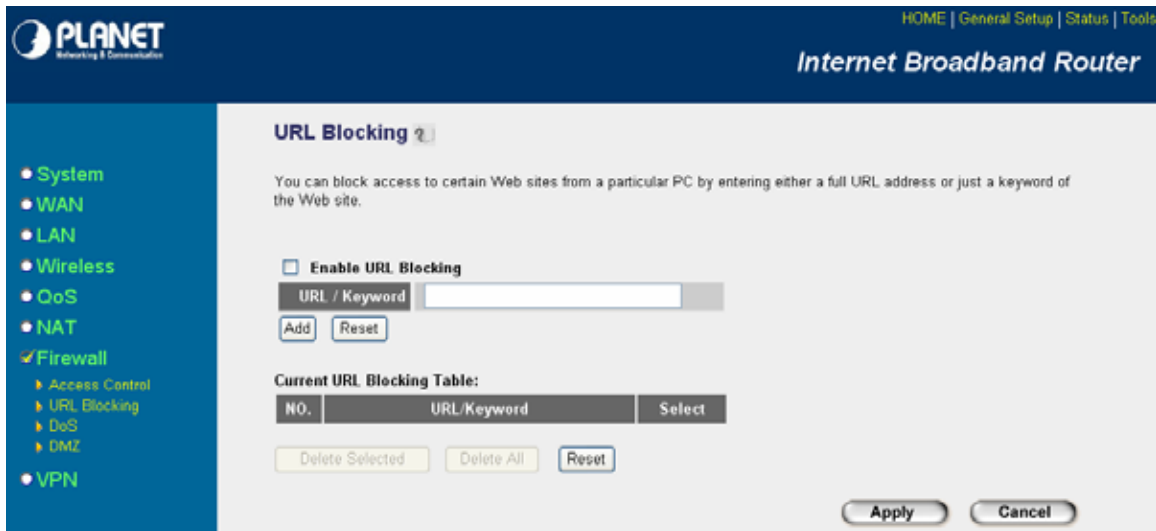

Parameters	Description
Enable URL Blocking	Enable/disable URL Blocking
Add URL Keyword	Fill in "URL/Keyword" and then click "Add". You can enter the full URL address or the keyword of the web site you want to block. If you find any typo before adding it and want to retype again, just click "Reset" and the field will be cleared.
Remove URL Keyword	If you want to remove some URL keyword from the "Current URL Blocking Table", select the URL keyword you want to remove in the table and then click "Delete Selected". If you want remove all URL keyword from the table, just click "Delete All" button. If you want to clear the selection and re-select again, just click "Reset".

You can now configure other advance sections or start using the router (with the advance settings in place)

2.7.3 DoS (Denial of Service)

The VRT-401G's firewall can block common hacker attacks, including Denial of Service, Ping of Death, Port Scan and Sync Flood. If Internet attacks occur the router can log the events.

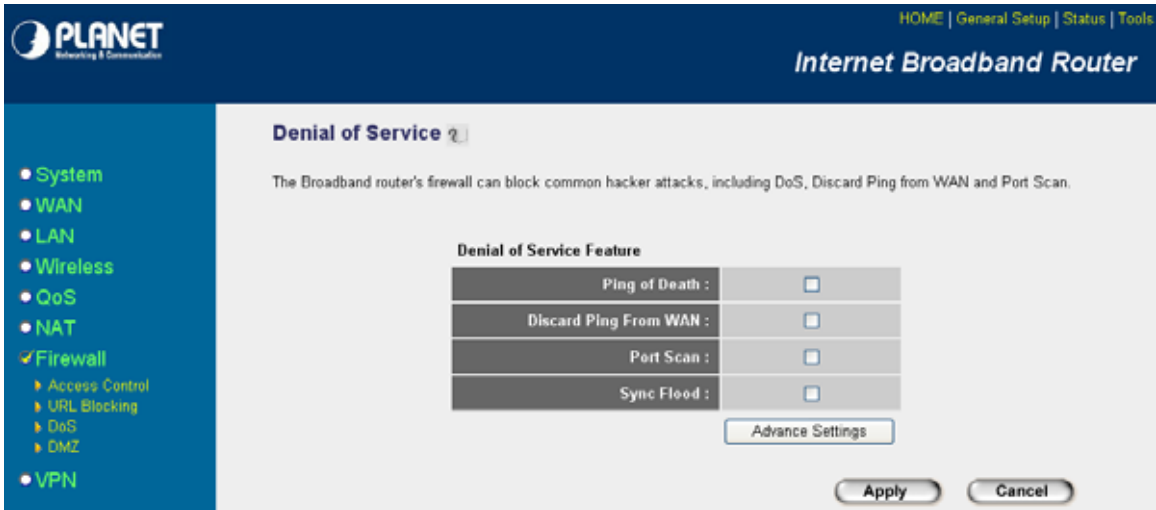

Parameters	Description
Denial of Service Feature	
Ping of Death	Protections from Ping of Death attack
Discard Ping From WAN	The router's WAN port will not respond to any Ping requests
Port Scan	Protection the router from Port Scan.
Sync Flood	Protection the router from Sync Flood attack.

Click **<Apply>** at the bottom of the screen to save the above configurations. You can now configure other advance sections or start using the router (with the advance settings in place)

Note: You can press **Advance Settings** to configure more detail settings per each DoS feature if necessary.

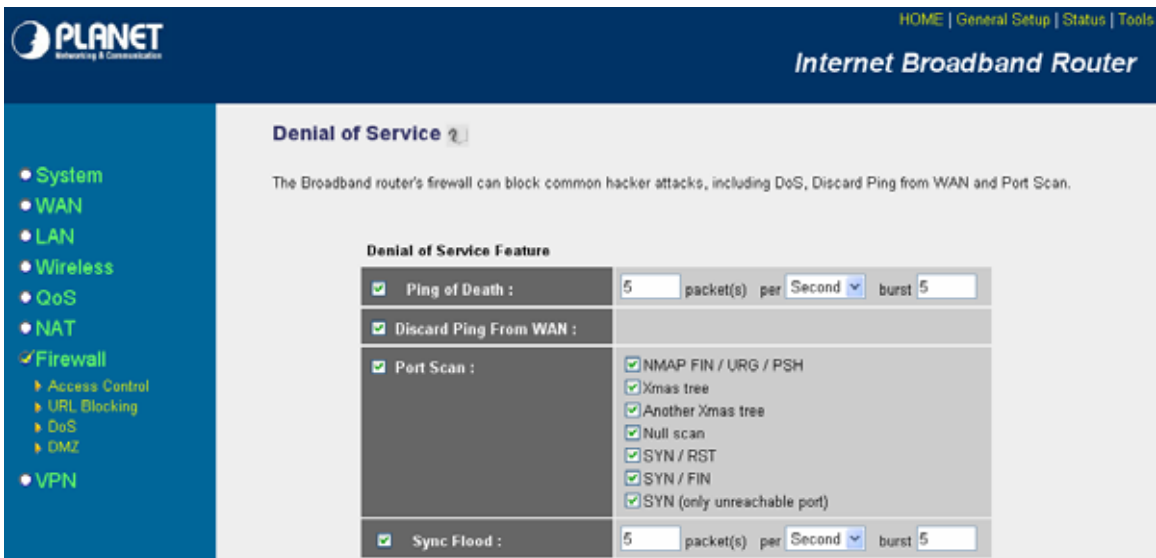

2.7.4 DMZ

If you have a local client PC that cannot run an Internet application (e.g. Games) properly from behind the NAT firewall, then you can open the client up to unrestricted two-way Internet access by defining a DMZ Host. The DMZ function allows you to re-direct all packets going to your WAN port IP address to a particular IP address in your LAN. The difference between the virtual server and the DMZ function is that the virtual server re-directs a particular service/Internet application (e.g. FTP, websites) to a particular LAN client/server, whereas DMZ re-directs all packets (regardless of services) going to your WAN IP address to a particular LAN client/server.

Parameters	Description
Enable DMZ	Enable/disable DMZ Note: If there is a conflict between the Virtual Server and the DMZ setting, then Virtual Server function will have priority over the DMZ function.
Public IP Address	The IP address of the WAN port or any other Public IP addresses given to you by your ISP
Client PC IP Address	Input the IP address of a particular host in your LAN that will receive all the packets originally going to the WAN port/Public IP address above Note: You need to give your LAN PC clients a fixed/static IP address for DMZ to work properly.

You can now configure other advance sections or start using the router (with the advance settings in place

2.8 VPN

Virtual Private Network (VPN) provides a secure, private communication tunnel between two or more devices across the Internet. These VPN devices can be either a computer running VPN software or a special device like a VPN enabled router. It allows your home computer to be connected to your office network or can allow two home computers in different locations to connect to each over the Internet.

Note: To enable the VPN settings select **Enable** and click **Apply**



Parameters	Description
2.8.1 IPsec Server	IPsec Server allows you to set up a server that enables secure data transfer between two devices or private networks.
2.8.2 L2TP Server	L2TP Server allows you to set up a server that allows users connect with L2TP over IPsec protocol.
2.8.3 PPTP Server	PPTP Server allows you to set up a server that allows users connect with PPTP protocol.

Click on one of the VPN selections and proceed to the manual's relevant sub-section

2.8.1 IPsec Server

IPsec (IP Security Protocol) is an extended IP protocol which enables secure data transfer. It provides services similar to SSL/TLS, however, these services are provided on a network layer.

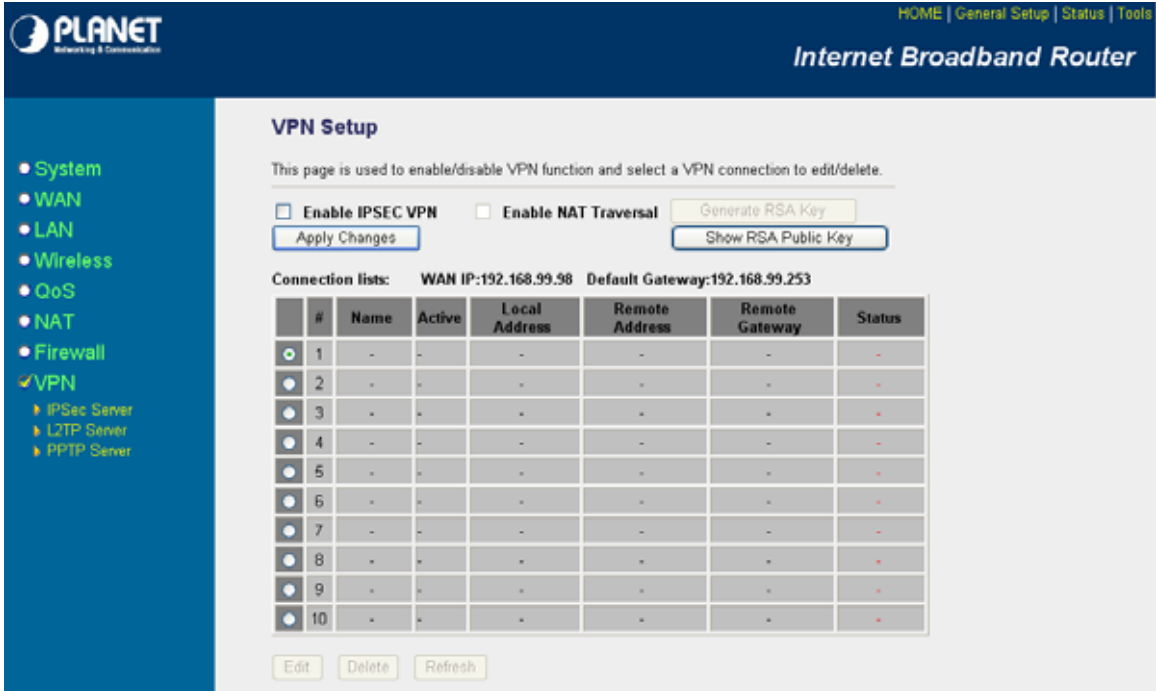

Parameters	Description
Enable IPSEC VPN	Enable the IPsec VPN Server.
Enable NAT Traversal	Enable the NAT Traversal function allows the clients behind NAT to connect to this VPN server.
Generate RSA Key	Automatically generate the RSA Public Key.
Show RSA Public Key	Click this button to show the RSA Public Key.



Current VPN Connection Table	This table shows the current tunnel settings and the status of each tunnel. The maximum number of tunnel is 10.
WAN IP	Shows the current WAN IP that this VPN Server listened on.
Edit a VPN Connection	Select the connection you want to edit and click "Edit", then you will enter the detail form of the Tunnel Setting. Click "Apply Changes" after editing the form and the tunnel setting will be saved.

Click **<Apply Changes>** at the bottom of the screen to save the above configurations. You can now configure other advance sections or start using the router (with the advance settings in place)

The screenshot shows the 'VPN Setup' configuration page on a Planet Internet Broadband Router. The page is divided into several sections:

- VPN Setup:**
 - Enable Tunnel 1**
 - Connection Name:** [Text Input]
 - Local Site:**
 - Subnet Address: [Dropdown]
 - Local IP/Network: [Text Input: 192.168.0.1]
 - Local Subnet Mask: [Text Input: 255.255.255.0]
 - Remote Site:**
 - Subnet Address: [Dropdown]
 - Remote IP/Network: [Text Input: 0.0.0.0]
 - Remote Subnet Mask: [Text Input: 0.0.0.0]
- Key Management:**
 - IKE Manual
 - Connection Type: [Dropdown: Responder]
- Local/Remote ID:**
 - Local ID Type: [Dropdown: IP]
 - Local ID: [Text Input]
 - Remote ID Type: [Dropdown: IP]
 - Remote ID: [Text Input]
- Auth Method:**
 - [Dropdown: PSK]
 - PreShared Key: [Text Input]
 - Remote RSA Key: [Text Input]
 - Status: **Disconnected**

At the bottom, there are buttons for 'Apply Changes', 'Reset', 'Refresh', and 'Back'.

Edit Connection

Parameters	Description
Enable Tunnel #	Check this check box to enable this tunnel setting.
Connection Name	The name of this connection. Note: The "Connection Name" can't be the same with other "Connection Name".
Local Site	You can choose which type of the local site is. It can be a single site or a subnet.
Remote Site	You can choose which type of the remote site is. It can be a single site, a subnet, any address, NAT Traversal any address, or L2TP Client. When you choose single site or subnet, you must specify the remote IP Address.
Network Management	Choose the key exchange method. It can be IKE or Manual setting.
Advanced	Press this button for the advanced setting of IKE.

Connection Type	When select the Initiator, the tunnel will automatically connect at the boot time. When select the Responder, the tunnel will connect only when you pressed the "Connect" button.
Local/Remote ID	Specify the ID of local site and remote site. It can be IP address, Domain Name, or E-Mail address.
Auth Method	Choose PSK or RSA and fill the key for the authentication.

Click **<Apply Changes>** at the bottom of the screen to save the above configurations. You can now configure other advance sections or start using the router (with the advance settings in place)



Advanced VPN Setting

Parameters	Description
Encryption	Choose the encryption type with the remote peer. It can be 3DES or AES128. Note: If you choose the wrong method, the connection may not be established.
Hash/Authentication	Choose the hash method with the remote peer. It can be MD5 or SHA1. Note: If you choose the wrong method, the connection may not be established.

Diffie Hellman

You can choose which Diffie Hellman protocol you want to use at the Phase 1.

Key Life Time

Enter the life time for the key. After this time, the key will expire.

PFS

If you turn on this option, the keys that protect data transmission are not used to derive additional keys. Also, seeds used to create data transmission keys are not reused.

Click <OK> at the bottom of the screen to save the above configurations.

2.8.2 L2TP Server

Layer Two Tunneling Protocol (L2TP) is an extension of the Point-to-Point Tunneling Protocol (PPTP). By enable this server, we can enable the operation of a virtual private network (VPN) over the Internet.

PLANET
Networking & Communications

HOME | General Setup | Status | Tools

Internet Broadband Router

L2TP Settings

You can enable the Broadband router's L2TP server to provide Remote-Access VPN service.

L2TP Server

Enable L2TP Server

Server IP Address :	0.0.0.0
Client IP Pool :	0.0.0.0 ~ 0.0.0.0
Authentication :	<input checked="" type="radio"/> PAP <input type="radio"/> CHAP <input type="radio"/> MS-CHAP
Encryption :	IPSec

VPN Users

ID	User Name	Password
1		
2		
3		
4		
5		
6		
7		
8		
9		
10		

Apply Cancel

L2TP Settings

Parameters	Description
Enable L2TP Server	By enable this server, we can enable the operation of a virtual private network (VPN) over the Internet.
Server IP Address	Specify the IP Address that the L2TP clients talked with. Note: The Server IP Address can be different to LAN IP or WAN IP.
Client IP Pool	Specify the IP Address for L2TP clients to use.
Authentication	You can use PAP, CHAP, or MSCHAP for authentication.
VPN Users	You can input up to ten usernames and passwords for the L2TP/PPTP clients here.

Click <**Apply**> at the bottom of the screen to save the above configurations.

Note: L2TP client IP address must be public IP.

2.8.3 PPTP Server

PPTP is a protocol from Microsoft that is used to create a virtual private network (VPN) over the Internet. It uses Microsoft's Point-to-Point Encryption (MPPE), which is based on RSA's RC4.

- System
- WAN
- LAN
- Wireless
- QoS
- NAT
- Firewall
- ✓ VPN
 - ▶ IPsec Server
 - ▶ L2TP Server
 - ▶ PPTP Server

PPTP Settings

You can enable the Broadband router's PPTP server to provide Remote-Access VPN service.

PPTP Server

Enable PPTP Server

Server IP Address :	<input type="text" value="0.0.0.0"/>
Client IP Pool :	<input type="text" value="0.0.0.0"/> ~ <input type="text" value="0.0.0.0"/>
Authentication :	<input checked="" type="radio"/> PAP <input type="radio"/> CHAP <input type="radio"/> MS-CHAP
Encryption :	<input checked="" type="radio"/> None <input type="radio"/> MPPE

VPN Users

ID	User Name	Password
1	<input type="text"/>	<input type="text"/>
2	<input type="text"/>	<input type="text"/>
3	<input type="text"/>	<input type="text"/>
4	<input type="text"/>	<input type="text"/>
5	<input type="text"/>	<input type="text"/>
6	<input type="text"/>	<input type="text"/>
7	<input type="text"/>	<input type="text"/>
8	<input type="text"/>	<input type="text"/>
9	<input type="text"/>	<input type="text"/>
10	<input type="text"/>	<input type="text"/>

PPTP Settings

Parameters	Description
Enable PPTP Server	By enable this server, we can enable the operation of a virtual private network (VPN) over the Internet.
Server IP Address	Specify the IP Address that the PPTP clients talked with. Note: The Server IP Address can be different to LAN IP or WAN IP.
Client IP Pool	Specify the IP Address for PPTP clients to use.
Authentication	You can use PAP, CHAP, or MSCHAP for authentication.
Encryption	When you choose MSCHAP for Authentication, you can use MPPE (Microsoft's Point-to-Point Encryption) to encryption the PPTP connection.
VPN Users	You can input up to ten usernames and passwords for the L2TP/PPTP clients here.

Click **<Apply>** at the bottom of the screen to save the above configurations.

Chapter 3

Status

The Status section allows you to monitor the current status of your router. You can use the Status page to monitor: the connection status of the VRT-401G's WAN/LAN interfaces, the current firmware and hardware version numbers, any illegal attempts to access your network, and information on all DHCP client PCs currently connected to your network.

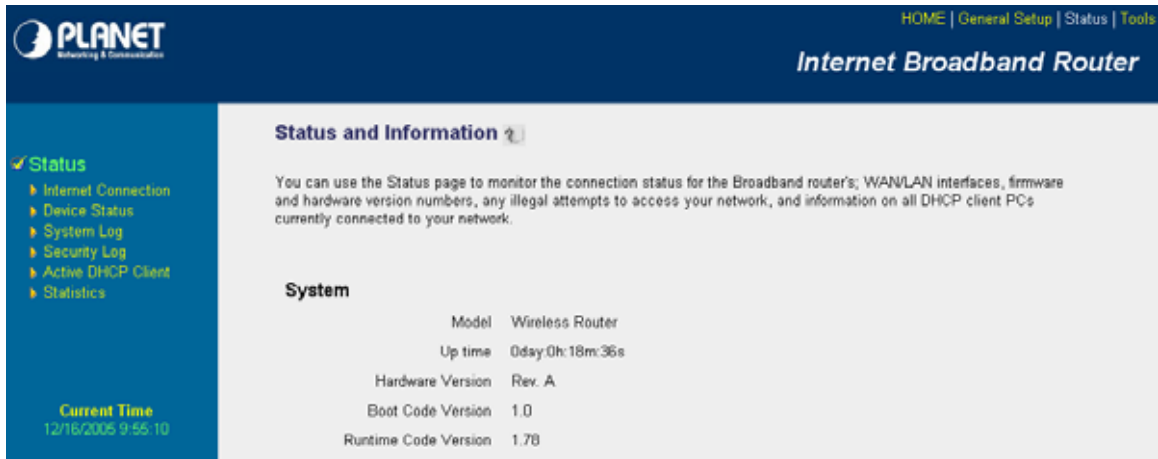

Parameters	Description
3.1 Status and Information	Shows the router's system information
3.2 Internet Connection	View the VRT-401Gs current Internet connection status and other related information
3.3 Device Status	View the VRT-401G's current setting status
3.4 System Log	View the VRT-401G's system log
3.5 Security Log	View any attempts that have been made to illegally gain access to your network.
3.6 Active DHCP Client	View your LAN client's information that is currently linked to the VRT-401G's DHCP server
3.7 Statistics	Shows the statistics

Select one of the above five Status selections and proceed to the manual's relevant sub-section

3.1 Status and Information

The Status and Information section allows you to view the router's system information

PLANET Networking & Communication

HOME | General Setup | Status | Tools

Internet Broadband Router

Status and Information

You can use the Status page to monitor the connection status for the Broadband router's; WAN/LAN interfaces, firmware and hardware version numbers, any illegal attempts to access your network, and information on all DHCP client PCs currently connected to your network.

System

Model	Wireless Router
Up time	0day:0h:18m:36s
Hardware Version	Rev. A
Boot Code Version	1.0
Runtime Code Version	1.7B

Current Time
12/16/2005 9:55:10

Parameters	Description
Information	You can see the router's system information such as the router's: LAN MAC Address, WAN MAC Address, Hardware version, Serial Number, Boot code Version, Runtime code Version

3.2 Internet Connection

View the VRT-401G's current Internet connection status and other related information

PLANET Networking & Communication

HOME | General Setup | Status | Tools

Internet Broadband Router

Internet Connection

View the current internet connection status and related information.

Attain IP Protocol :	Fixed IP connect
IP Address :	192.168.99.98
Subnet Mask :	255.255.255.0
Default Gateway :	192.168.99.253
MAC Address :	00:30:4F:64:7B:45
Primary DNS :	168.95.1.1
Secondary DNS :	

Current Time
12/16/2005 10:1:41

Parameters	Description
Internet Connection	This page displays whether the WAN port is connected to a Cable/DSL connection. It also displays the router's WAN port information, such as WAN IP address, Subnet Mask , and ISP Gateway as well as the Primary DNS and Secondary DNS being used.

3.3 Device Status

View the VRT-401G's current configuration settings. The Device Status displays the settings you've configured in the **Quick Setup Wizard/General Setup** section.

The screenshot shows the Planet Internet Broadband Router web interface. The top navigation bar includes 'HOME | General Setup | Status | Tools'. The left sidebar shows a 'Status' menu with options: Internet Connection, Device Status (selected), System Log, Security Log, Active DHCP Client, and Statistics. Below the menu, the 'Current Time' is displayed as 12/16/2005 10:7:53. The main content area is titled 'Device Status' and contains the text: 'View the current setting status of this device.' Below this text are two tables: 'Wireless Configuration' and 'LAN Configuration'.

Wireless Configuration	
Mode	AP
ESSID	default
Channel Number	11
Security	Disable
Associated Clients	1
BSSID	00:0e:2e:64:7b:44

LAN Configuration	
IP Address	192.168.0.1
Subnet Mask	255.255.255.0
DHCP Server	Enabled
MAC Address	00:0e:2e:64:7b:44

Parameters	Description
Device Status	This page shows the VRT-401G's current device settings. This page displays the VRT-401G LAN port's current LAN IP Address and Subnet Mask . It also shows whether the DHCP Server function is enabled or disabled.

3.4 System Log

View the operation log of the system.

PLANET Networking & Communication HOME | General Setup | Status | Tools

Internet Broadband Router

✔ **Status**

- ▶ Internet Connection
- ▶ Device Status
- ▶ System Log
- ▶ Security Log
- ▶ Active DHCP Client
- ▶ Statistics

Current Time
 12/16/2005 10:9:29

System Log ?

View the system operation information. You can see the system start up time, connection process...etc. here.

```

Dec 16 09:37:28 ipsec_setup: ...Openswan IPsec stopped
Dec 16 09:37:33 ipsec_setup: KLIPS ipsec0 on eth1 192.168.99.98/255.255.255.0 broadca
Dec 16 09:37:35 ipsec_plutorun: Starting Pluto subsystem...
Dec 16 09:37:36 ipsec_setup: ...Openswan IPsec started
Dec 16 09:37:36 pluto[1117]: Starting Pluto (Openswan Version 1.0.1)
Dec 16 09:37:36 pluto[1117]: including X.509 patch with traffic selectors (Version
Dec 16 09:37:36 pluto[1117]: including NAT-Traversal patch (Version 0.6) [disabled]
Dec 16 09:37:36 pluto[1117]: ike_alg_register_enc(): Activating OAKLEY_AES_CBC: Ok (r
Dec 16 09:37:36 pluto[1117]: Changing to directory '/etc/ipsec.d/cacerts'
            
```

Parameters	Description
System Log	<p>This page shows the current system log of the VRT-401G. It displays any event occurred after system start up.</p> <p>At the bottom of the page, the system log can be saved <Save> to a local file for further processing or the system log can be cleared <Clear> or it can be refreshed <Refresh> to get the most updated situation. When the system is powered down, the system log will disappear if not saved to a local file.</p>

3.5 Security Log

View any attempts that have been made to illegally gain access to your network.

PLANET Networking & Communication HOME | General Setup | Status | Tools

Internet Broadband Router

✔ **Status**

- ▶ Internet Connection
- ▶ Device Status
- ▶ System Log
- ▶ Security Log
- ▶ Active DHCP Client
- ▶ Statistics

Current Time
 12/16/2005 10:11:24

Security Log ?

View any attempts that have been made to illegally gain access to your network.

```

[2000-01-01 00:00:23]: start Static IP
[2000-01-01 00:00:26]: [SNTP]: connect to TimeServer 192.43.244.10 ...
[2005-12-16 09:37:01]: [SNTP]: connect success!
[2005-12-16 09:37:01]: [SNTP]: set time to 2005-12-16 09:37:01
[2005-12-16 09:37:02]: [FIREWALL]: WAN IP is 192.168.99.98 setting firewall...
            
```

Parameters	Description
------------	-------------

Security Log

This page shows the current security log of the VRT-401G. It displays any illegal attempts to access your network.

At the bottom of the page, the security log can be saved <**Save**> to a local file for further processing or the security log can be cleared <**Clear**> or it can be refreshed <**Refresh**> to get the most updated situation. When the system is powered down, the security log will disappear if not saved to a local file.

3.6 Active DHCP Client

View your LAN client's information that is currently linked to the VRT-401G's DHCP server

The screenshot shows the PLANET Internet Broadband Router web interface. The main content area is titled "Active DHCP Client" and includes a table of active clients. The table has three columns: IP Address, MAC Address, and Time Expired(s). Two clients are listed: 192.168.0.100 (MAC: 00:0e:a6:0f:6b:92) and 192.168.0.101 (MAC: 00:d0:59:59:79:2d), both with a "forever" expiration time. A "Refresh" button is located below the table. The left sidebar contains a "Status" menu with options for Internet Connection, Device Status, System Log, Security Log, Active DHCP Client, and Statistics. The current time is displayed as 12/16/2005 10:13:46.

Parameters

Description

Active DHCP Client

This page shows all DHCP clients (LAN PCs) currently connected to your network. The "Active DHCP Client Table" displays the **IP** address and the **MAC** address and Time Expired of each LAN Client. Use the **Refresh** button to get the most updated situation

3.7 Statistics

View the statistics of packets sent and received on WAN, LAN and Wireless LAN.

✓ **Status**

- ▶ Internet Connection
- ▶ Device Status
- ▶ System Log
- ▶ Security Log
- ▶ Active DHCP Client
- ▶ **Statistics**

Current Time
12/16/2006 10:15:35

Statistics ?

This page shows the packet counters for transmission and reception regarding to networks.

Wireless LAN	Sent Packets	220
	Received Packets	22183
Ethernet LAN	Sent Packets	266
	Received Packets	360
Ethernet WAN	Sent Packets	90
	Received Packets	1511

Parameters	Description
Statistics	Shows the counters of packets sent and received on WAN, LAN and Wireless LAN.

Chapter 4

Tool

This page includes the basic configuration tools, such as Configuration Tools (save or restore configuration settings), Firmware Upgrade (upgrade system firmware) and Reset.

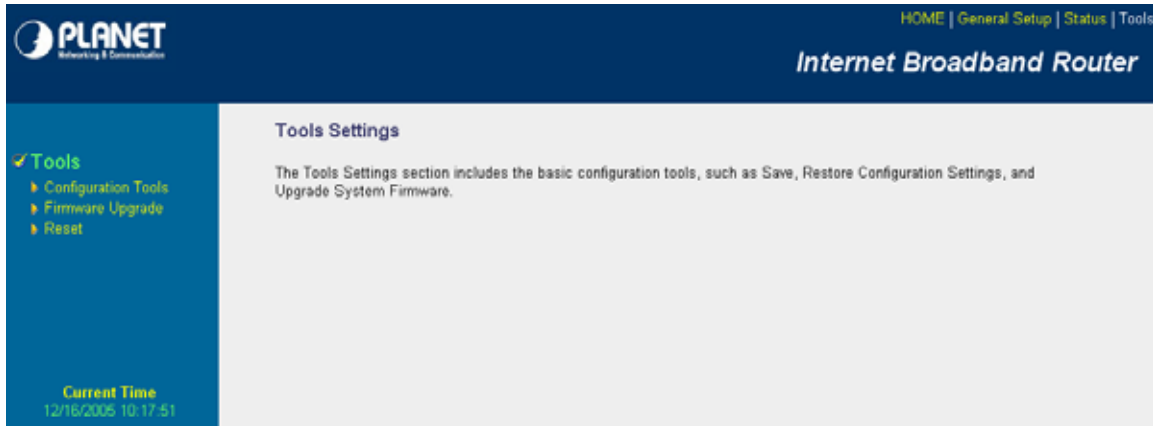

Parameters	Description
4.1 Configuration Tools	You can save the router's current configuration, restore the router's saved configuration files and restore the router's factory default settings
4.2 Firmware Upgrade	This page allows you to upgrade the router's firmware
4.3 Reset	You can reset the router's system should any problem exist

Select one of the above three **Tools Settings** selection and proceed to the manual's relevant sub-section

4.1 Configuration Tools

The Configuration Tools screen allows you to save (**Backup**) the router's current configuration setting. Saving the configuration settings provides an added protection and convenience should problems occur with the router and you have to reset to factory default. When you save the configuration setting (Backup) you can re-load the saved configuration into the router through the **Restore** selection. If extreme problems occur you can use the **Restore to Factory Defaults** selection, this will set all configurations to its original default settings (e.g. when you first purchased the router).

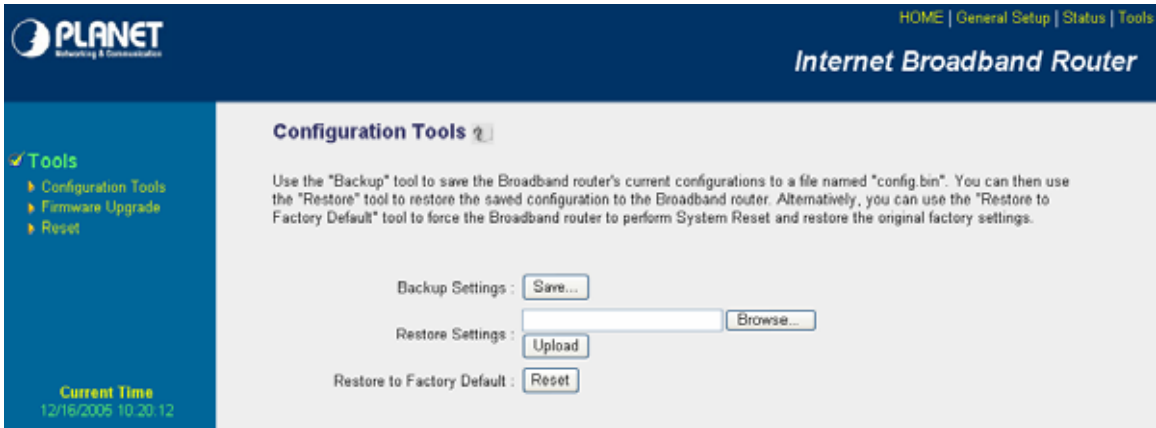

Parameters	Description
Configuration Tools	Use the " Backup " tool to save the VRT-401G current configuration to a file named "config.bin" on your PC. You can then use the " Restore " tool to restore the saved configuration to the VRT-401G. Alternatively, you can use the " Restore to Factory Defaults " tool to force the VRT-401G to perform a power reset and restore the original factory settings.

4.2 Firmware Upgrade

This page allows you to upgrade the router's firmware

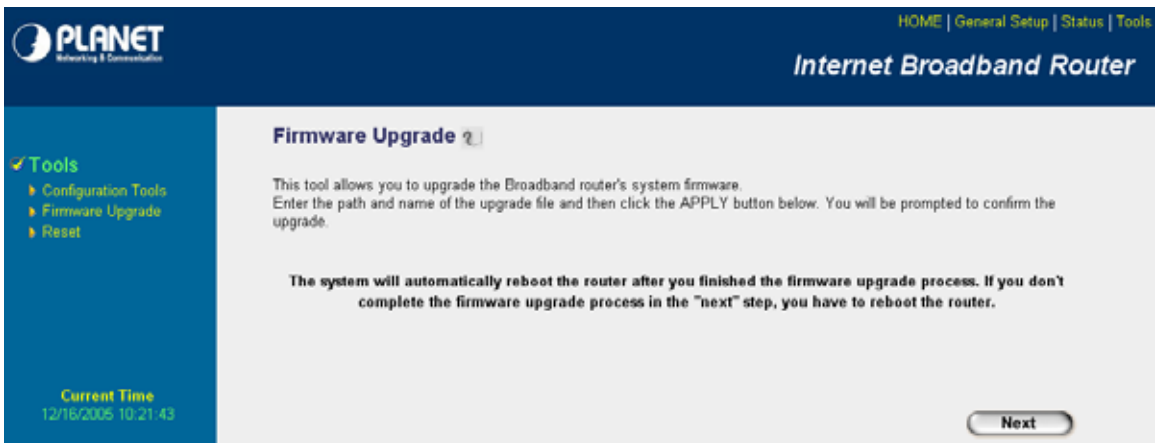

Parameters	Description
Firmware Upgrade	This tool allows you to upgrade the VRT-401G's system firmware. To upgrade the firmware of your device, you need to download the firmware file to your local hard disk, and enter that file name and path in the appropriate field on this page. You can also use the Browse button to find the firmware file on your PC.

Once you've selected the new firmware file, click <Apply> at the bottom of the screen to start the upgrade process. (You may have to wait a few minutes for the upgrade to complete). Once the upgrade is complete you can start using the router.

4.3 Reset

You can reset the router's system should any problem exist. The reset function essentially re-boots your router's system



Parameters	Description
Reset	In the event that the system stops responding correctly or in some way stops functioning, you can perform a reset. Your settings will not be changed. To perform the reset, click on the <APPLY> button, you will be asked to confirm your decision. The reset will be complete when the power light stops blinking. Once the reset process is complete you may start using the router again.

Appendix A

How to Manually find your PC's IP and MAC address

- 1) In Window's open the Command Prompt program

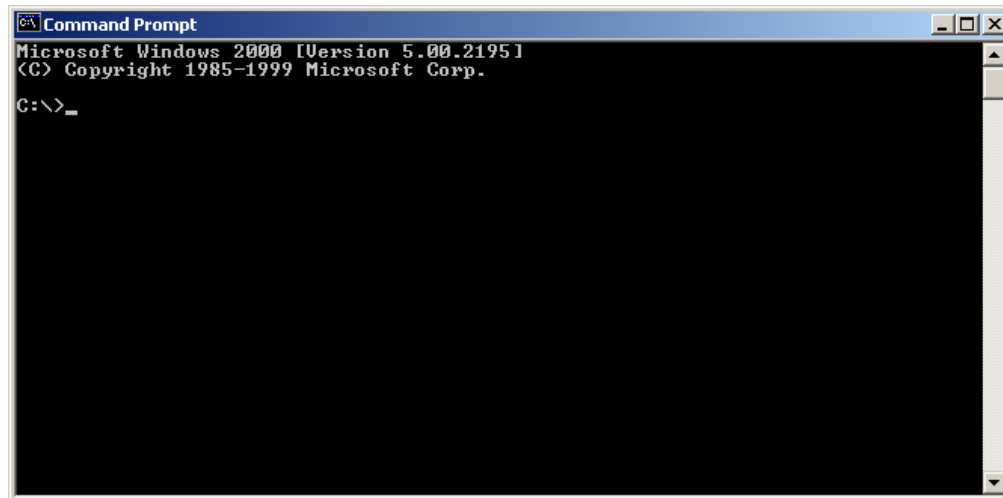

```
Command Prompt
Microsoft Windows 2000 [Version 5.00.2195]
(C) Copyright 1985-1999 Microsoft Corp.

C:\>_
```

- 2) Type **Ipconfig /all** and <enter>

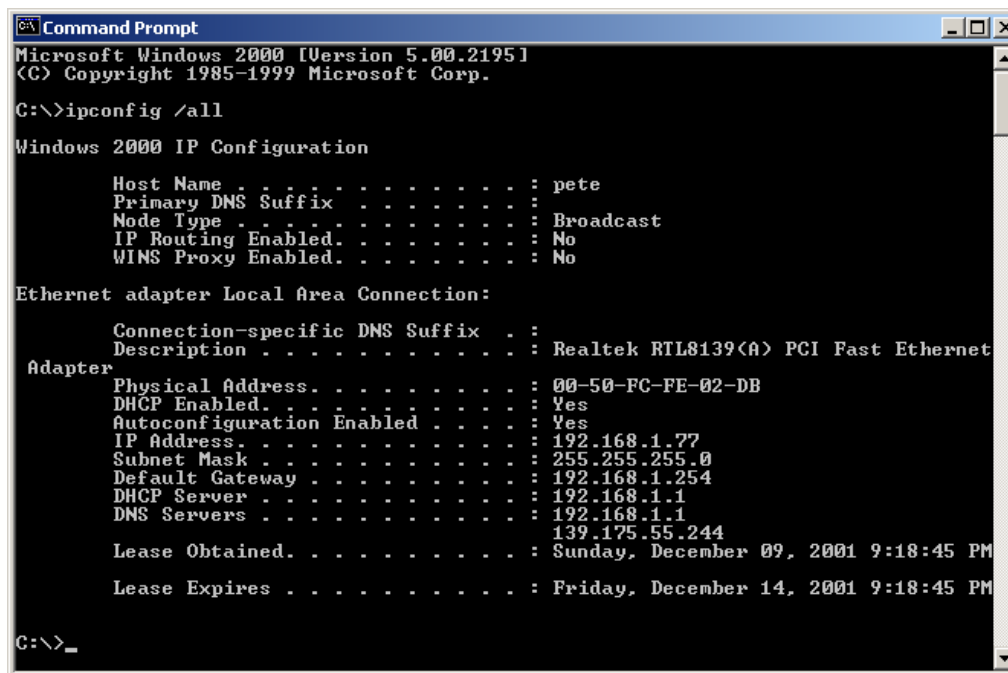

```
Command Prompt
Microsoft Windows 2000 [Version 5.00.2195]
(C) Copyright 1985-1999 Microsoft Corp.

C:\>ipconfig /all

Windows 2000 IP Configuration

    Host Name . . . . . : pete
    Primary DNS Suffix . . . . . :
    Node Type . . . . . : Broadcast
    IP Routing Enabled. . . . . : No
    WINS Proxy Enabled. . . . . : No

Ethernet adapter Local Area Connection:

    Connection-specific DNS Suffix . :
    Description . . . . . : Realtek RTL8139(A) PCI Fast Ethernet
    Adapter
    Physical Address. . . . . : 00-50-FC-FE-02-DB
    DHCP Enabled. . . . . : Yes
    Autoconfiguration Enabled . . . . : Yes
    IP Address . . . . . : 192.168.1.77
    Subnet Mask . . . . . : 255.255.255.0
    Default Gateway . . . . . : 192.168.1.254
    DHCP Server . . . . . : 192.168.1.1
    DNS Servers . . . . . : 192.168.1.1
    . . . . . : 139.175.55.244
    Lease Obtained. . . . . : Sunday, December 09, 2001 9:18:45 PM
    Lease Expires . . . . . : Friday, December 14, 2001 9:18:45 PM

C:\>_
```

- Your PC's IP address is the one entitled **IP address** (192.168.1.77)
- The router's IP address is the one entitled **Default Gateway** (192.168.1.254)
- Your PC's MAC Address is the one entitled **Physical Address** (00-50-FC-FE-02-DB)

Glossary

Default Gateway (Router): Every non-router IP device needs to configure a default gateway's IP address. When the device sends out an IP packet, if the destination is not on the same network, the device has to send the packet to its default gateway, which will then send it out towards the destination.

DHCP: Dynamic Host Configuration Protocol. This protocol automatically gives every computer on your home network an IP address.

DNS Server IP Address: DNS stands for Domain Name System, which allows Internet servers to have a domain name (such as www.Broadbandrouter.com) and one or more IP addresses (such as 192.34.45.8). A DNS server keeps a database of Internet servers and their respective domain names and IP addresses, so that when a domain name is requested (as in typing "Broadbandrouter.com" into your Internet browser), the user is sent to the proper IP address. The DNS server IP address used by the computers on your home network is the location of the DNS server your ISP has assigned to you.

DSL Modem: DSL stands for Digital Subscriber Line. A DSL modem uses your existing phone lines to transmit data at high speeds.

Ethernet: A standard for computer networks. Ethernet networks are connected by special cables and hubs, and move data around at up to 10/100 million bits per second (Mbps).

Idle Timeout: Idle Timeout is designed so that after there is no traffic to the Internet for a pre-configured amount of time, the connection will automatically be disconnected.

IP Address and Network (Subnet) Mask: IP stands for Internet Protocol. An IP address consists of a series of four numbers separated by periods, that identifies a single, unique Internet computer host in an IP network. Example: 192.168.2.1. It consists of 2 portions: the IP network address, and the host identifier.

The IP address is a 32-bit binary pattern, which can be represented as four cascaded decimal numbers separated by ".": `aaa.aaa.aaa.aaa`, where each "aaa" can be anything from 000 to 255, or as four cascaded binary numbers separated by ".": `bbbbbbbb.bbbbbbbb.bbbbbbbb.bbbbbbbb`, where each "b" can either be 0 or 1.

A network mask is also a 32-bit binary pattern, and consists of consecutive leading 1's followed by consecutive trailing 0's, such as `11111111.11111111.11111111.00000000`. Therefore sometimes a network mask can also be described simply as "x" number of leading 1's.

When both are represented side by side in their binary forms, all bits in the IP address that correspond to 1's in the network mask become part of the IP network address, and the remaining bits correspond to the host ID.

For example, if the IP address for a device is, in its binary form, `11011001.10110000.10010000.00000111`, and if its network mask is, `11111111.11111111.11110000.00000000`

It means the device's network address is

`11011001.10110000.10010000.00000000`, and its host ID is, `00000000.00000000.00000000.00000111`. This is a convenient and efficient method for routers to route IP packets to their destination.

ISP Gateway Address: (see ISP for definition). The ISP Gateway Address is an IP address for the Internet router located at the ISP's office.

ISP: Internet Service Provider. An ISP is a business that provides connectivity to the Internet for individuals and other businesses or organizations.

LAN: Local Area Network. A LAN is a group of computers and devices connected together in a relatively small area (such as a house or an office). Your home network is considered a LAN.

MAC Address: MAC stands for Media Access Control. A MAC address is the hardware address of a device connected to a network. The MAC address is a unique identifier for a device with an Ethernet interface. It is comprised of two parts: 3 bytes of data that corresponds to the Manufacturer ID (unique for each manufacturer), plus 3 bytes that are often used as the product's serial number.

NAT: Network Address Translation. This process allows all of the computers on your home network to use one IP address. Using the broadband router's NAT capability, you can access the Internet from any computer on your home network without having to purchase more IP addresses from your ISP.

Port: Network Clients (LAN PC) uses port numbers to distinguish one network application/protocol over another. Below is a list of common applications and protocol/port numbers:

Application	Protocol	Port Number
Telnet	TCP	23
FTP	TCP	21
SMTP	TCP	25
POP3	TCP	110
H.323	TCP	1720
SNMP	UCP	161
SNMP Trap	UDP	162
HTTP	TCP	80
PPTP	TCP	1723
PC Anywhere	TCP	5631
PC Anywhere	UDP	5632

PPPoE: Point-to-Point Protocol over Ethernet. Point-to-Point Protocol is a secure data transmission method originally created for dial-up connections; PPPoE is for Ethernet connections. PPPoE relies on two widely accepted standards, Ethernet and the Point-to-Point Protocol. It is a communications protocol for transmitting information over Ethernet between different manufacturers

Protocol: A protocol is a set of rules for interaction agreed upon between multiple parties so that when they interface with each other based on such a protocol, the interpretation of their behavior is well defined and can be made objectively, without confusion or misunderstanding.

Router: A router is an intelligent network device that forwards packets between different networks based on network layer address information such as IP addresses.

Subnet Mask: A subnet mask, which may be a part of the TCP/IP information provided by your ISP, is a set of four numbers (e.g. 255.255.255.0) configured like an IP address. It is used to

create IP address numbers used only within a particular network (as opposed to valid IP address numbers recognized by the Internet, which must be assigned by InterNIC).

TCP/IP, UDP: Transmission Control Protocol/Internet Protocol (TCP/IP) and Unreliable Datagram Protocol (UDP). TCP/IP is the standard protocol for data transmission over the Internet. Both TCP and UDP are transport layer protocol. TCP performs proper error detection and error recovery, and thus is reliable. UDP on the other hand is not reliable. They both run on top of the IP (Internet Protocol), a network layer protocol.

WAN: Wide Area Network. A network that connects computers located in geographically separate areas (e.g. different buildings, cities, countries). The Internet is a wide area network.

Web-based management Graphical User Interface (GUI): Many devices support a graphical user interface that is based on the web browser. This means the user can use the familiar Netscape or Microsoft Internet Explorer to Control/configure or monitor the device being managed.

Free Manuals Download Website

<http://myh66.com>

<http://usermanuals.us>

<http://www.somanuals.com>

<http://www.4manuals.cc>

<http://www.manual-lib.com>

<http://www.404manual.com>

<http://www.luxmanual.com>

<http://aubethermostatmanual.com>

Golf course search by state

<http://golfingnear.com>

Email search by domain

<http://emailbydomain.com>

Auto manuals search

<http://auto.somanuals.com>

TV manuals search

<http://tv.somanuals.com>