

24-Port 10/100Mbps PoE + 2-Gigabit Web Smart Ethernet Switch

**FGSW-2402PVS
FGSW-2620PVS**

User's Manual



Trademarks

Copyright © PLANET Technology Corp. 2005.
Contents subject to revision without prior notice.

PLANET is a registered trademark of PLANET Technology Corp. All other trademarks belong to their respective owners.

Disclaimer

PLANET Technology does not warrant that the hardware will work properly in all environments and applications, and makes no warranty and representation, either implied or expressed, with respect to the quality, performance, merchantability, or fitness for a particular purpose.

PLANET has made every effort to ensure that this User's Manual is accurate; PLANET disclaims liability for any inaccuracies or omissions that may have occurred.

Information in this User's Manual is subject to change without notice and does not represent a commitment on the part of PLANET. PLANET assumes no responsibility for any inaccuracies that may be contained in this User's Manual. PLANET makes no commitment to update or keep current the information in this User's Manual, and reserves the right to make improvements to this User's Manual and/or to the products described in this User's Manual, at any time without notice.

If you find information in this manual that is incorrect, misleading, or incomplete, we would appreciate your comments and suggestions.

FCC Warning

This equipment has been tested and found to comply with the limits for a Class A digital device, pursuant to Part 15 of the FCC Rules. These limits are designed to provide reasonable protection against harmful interference when the equipment is operated in a commercial environment. This equipment generates, uses, and can radiate radio frequency energy and, if not installed and used in accordance with the Instruction manual, may cause harmful interference to radio communications. Operation of this equipment in a residential area is likely to cause harmful interference in which case the user will be required to correct the interference at his own expense.

CE Mark Warning

This is a Class A product. In a domestic environment, this product may cause radio interference, in which case the user may be required to take adequate measures.

Revision

PLANET 24-Port 10/100Mbps PoE + 2-Gigabit Web Smart Ethernet Switch User's Manual

FOR MODEL: FGSW-2402PVS / FGSW-2620PVS

Rev: 1.0(Feb. 2005)

Part No.: 2010-000031-000

TABLE OF CONTENTS

1. INTRODUCTION.....	1
1.1 PACKAGE CONTENTS.....	1
1.2 HOW TO USE THIS MANUAL	1
1.3 PRODUCT FEATURES.....	1
1.4 PRODUCT SPECIFICATIONS	2
2. INSTALLATION	4
2.1 PRODUCT DESCRIPTION	4
2.1.1 Product Overview.....	4
2.1.2 FGSW-2402PVS/FGSW-2620PVS Front Panel.....	4
2.1.3 LED Indicators	4
2.1.4 Extension Slots	5
2.1.5 FGSW-2402PVS/FGSW-2620PVS Rear Panel.....	5
2.2 INSTALLING FGSW-2402PVS/FGSW-2620PVS.....	5
2.2.1 Desktop Installation.....	5
2.2.2 Rack Mounting.....	6
3. CONSOLE CONFIGURATION	8
3.1 PREPARING FOR CONFIGURATION.....	8
3.1.1 Connecting a PC or Terminal to the RS-232 Port.....	8
3.1.2 Terminal Emulation Setup Program	8
3.1.3 Power-up Self-test Status	8
3.1.4 Login	9
3.2 GETTING STARTED	9
3.2.1 General Guidelines	9
3.2.2 Main Menu Screen	9
3.2.3 Port Status	10
3.2.4 Port Configuration.....	11
3.2.5 Trunk Configuration.....	12
3.2.6 VLAN Configure	12
3.2.7 Port Mirroring Configuration.....	17
3.2.8 QoS Configuration.....	18
3.2.9 Bandwidth Control.....	19
3.2.10 Misc Configuration	20
3.2.11 PoE Configuration.....	25
3.2.12 Logout.....	27
4. WEB CONFIGURATION	28
4.1 LOGIN IN TO THE SWITCH.....	28
4.2 MAIN MENU.....	28
4.3 PORT STATUS	29
4.4 PORT CONFIGURATION	29
4.5 TRUNK CONFIGURATION	30
4.6 VLAN CONFIGURATION	31
4.7 PORT MIRRORING CONFIGURATION.....	32
4.8 QOS CONFIGURATION	33
4.9 BANDWIDTH CONTROL.....	34
4.10 MISC CONFIGURATION.....	35
4.10.1 Advanced Switch Configuration	35
4.10.2 Password Setting	37
4.10.3 Reset System Default Setting	39
4.10.4 Reboot System.....	39
4.10.5 System Information	39
4.10.6 IP Configuration	40
4.11 POE CONFIGURATION.....	40
4.11.1 POE Ports.....	41
4.11.2 PoE Ports Status.....	41
4.12 LOGOUT.....	42
5. SWITCH OPERATION.....	43

5.1 ADDRESS TABLE	43
5.2 LEARNING	43
5.3 FORWARDING & FILTERING	43
5.4 STORE-AND-FORWARD	43
5.5 AUTO-NEGOTIATION	43
6. TROUBLESHOOTING.....	44
APPENDIX A	45
A.1 SWITCH'S RJ-45 PIN ASSIGNMENTS	45
A.2 10/100MBPS, 10/100BASE-TX	45

1. INTRODUCTION

1.1 Package Contents

Check the contents of your package for following parts:

- 24-Port 10/100Mbps PoE + 2-Gigabit Web smart Switch x1
- User's manual x1
- RS-232 cable x1
- Power cord x1
- Two Rack-Mounting Brackets with Attachment Screws x1

If any of these are missing or damaged, please contact your dealer immediately, if possible, retain the carton including the original packing material, and use them against to repack the product in case there is a need return to it to us for repairing.

1.2 How to Use This Manual

This 24-Port 10/100Mbps +2-Gigabit Web Smart Power over Ethernet Switch User's Manual is structured as follows:

- Section 2, **Installation**

It explains the functions of FGSW-2402PVS/FGSW-2620PVS and how to physically install the FGSW-2402PVS/FGSW-2620PVS.

- Section 3, **Console Configuration**

It contains information about the smart function from the console interface of FGSW-2402PVS/FGSW-2620PVS.

- Section 4, **Web Configuration**

It contains information about the smart function from the Web interface of FGSW-2402PVS/FGSW-2620PVS.

- Section 5 **Switch operation**

It explains the Switch operation of FGSW-2402PVS / FGSW-2620PVS.

- Section 6 **Troubleshooting**

It contains troubleshooting guide of FGSW-2402PVS / FGSW-2620PVS.

- **Appendix A**

It contains cable information of FGSW-2402PVS /FGSW-2620PVS.

In the following section, the term "**Switch**" means the two Switches, i.e. FGSW-2402PVS and FGSW-2620PVS; term of "**switch**" can be any third part switches.

1.3 Product Features

- Complies with the IEEE802.3, IEEE802.3u, IEEE802.3z, IEEE802.3ab Gigabit Ethernet, and IEEE802.3af Power over Ethernet standard
- 24-Port 10/100 Mbps Fast Ethernet Switch
- Each Switching ports support auto-negotiation-10/20, 100/200Mbps supported
- Support full 48VDC power for any remote IEEE802.3af powered device (PD) like Wireless LAN Access Point, IP phone, and LAN Camera.
- Supporting power supply of 260 watts that provides sufficient power to the 24 remote devices.
- Each Switching ports support full 48VDC power over unused twisted-pair wires to IEEE802.3af Powered Device.
- 2 open slots for 10/100Base-TX, 1000Base-T and 100Base-FX, 1000Base-SX/LX fiber-optic interface with various connection media and distances (FGSW-2402PVS only)

- 2 10/100/1000Mbps ports and 2 SFP interfaces (FGSW-2620PVS only)
- Auto-MDI/MDI-X detection on each RJ-45 port
- Prevents packet loss with back pressure (half-duplex) and 802.3x PAUSE frame flow control (full-duplex)
- High performance Store and Forward architecture, broadcast storm control, runt/CRC filtering eliminates erroneous packets to optimize the network bandwidth
- 6K MAC address table, automatic source address learning and ageing
- 4 Mbit embedded memory for packet buffers
- Console and Web interface for Switch basic management and setup
- Support up to 26 port-based VLAN groups
- Support up to 7 Trunk groups, each trunk for up to maximum 4 port with 800Mbps bandwidth
- Port mirroring allows monitoring of the traffic across any port in real time
- Support QoS and bandwidth control on each port
- Misc Configuration for Switch advanced configuration

1.4 Product Specifications

Model	FGSW-2402PVS /	FGSW-2620PVS
Hardware Specification		
Network ports	24 10/100Base-TX RJ-45 MDI/MDI-X ports	
Module slot (FGSW-2402PVS only)	2 open slots for 10/100Base-TX, 1000Base-T and 100Base-FX, 1000Base-SX/LX fiber-optic interface	
Gigabit ports (FGSW-2620PVS only)	2 10/100/1000Mbps ports and 2 SFP interfaces	
Console port	1 RS-232 DB-9 male	
Dimensions	440 x 200 x 44 mm (1U height)	
Weight	2.6 kg	
Power Requirement	100~240 (±10%) VAC, 50-60 (±3) Hz	
Power Consumption	30 Watts maximum / 102 BTU/hr maximum	
Switch Specification		
Switch architecture	Store-and-forward	
Address Table	6K entries, auto learning/ageing	
Shared data Buffer	4 Mbit embedded memory for packet buffers	
Flow Control	Back pressure for half duplex, IEEE 802.3x for full-duplex	
Packet Control	Runt & CRC filtering, Broadcast storm control	
Switching Fabric	8.8Gbps	
PoE power feeding	48VDC	
PoE power consumption	260 Watts max. / 800 BTU	
Switch Management		
Port Configuration	Port disable/enable. Auto-negotiation disable/enable. 10/100Mbps full and half duplex mode selection. Flow control disable/enable PoE power supply enable/disable, power feeding priority	
Port Status	Display each port's disable/enable status, each port's link status, and speed duplex mode. Flow control status PoE power consumption, power injection status	
Trunk	7-trunk groups with up to 4-port per trunk	
VLAN	26 Port-based VLAN groups	
Port Mirroring	1 Mirroring port to monitor several mirrored ports. The monitor modes are Disable, RX, TX, TX& RX	

QoS	Allow to assign low and high priority on each port
Bandwidth control	Allow to assign rate control on each port
PoE Configuration	Allow to Enable/Disable PoE function, setting power feeding priority, view PD power usage status.
Standards Conformance	
Network Standards	IEEE 802.3 (Ethernet), IEEE 802.3u (Fast Ethernet) IEEE 802.3z(Gigabit Ethernet) IEEE 802.3ab (Gigabit Ethernet) IEEE802.3x (Flow control) IEEE 802.1p QoS IEEE802.3af Power over Ethernet
Operating Temperature	0~50°C
Storage Temperature	-40~70°C
Humidity	5% to 95% (Non-condensing)
Regulation Compliance	FCC Class A, VCCI Class A, CISPR 22 Class A

2. INSTALLATION

This section describes the functionalities of FGSW-2402PVS/ FGSW-2620PVS components and guides how to install it on the desktop or shelf. Basic knowledge of networking is assumed. Please read this chapter completely before continuing.

2.1 Product Description

The PLANET Switch provides 24 10/100Mbps Fast Ethernet ports with 2 open slots or 2 fixed 10/100/1000Mbps ports (port25, 26). The two open slots can be installed by either 10/100Base-TX TP port or 1000Base-T TP port and 100Base-FX or 1000Base-SX/ LX fiber-optic interfaces. The distance range is 100 meters (TP) and 2 kilometers (Multi-mode, ST or SC), up to 15 kilometers (Single-mode, SC). The Switch with non-blocking backplane and simplifies the task of upgrading your LAN to cater for increased bandwidth demand.

Both switches are equipped with non-blocking 8.8Gbps backplane greatly simplify the tasks of upgrading your LAN to cater to increased bandwidth demands. The PoE, in-line power, following the standard IEEE802.3af, makes the both switches able to power 24 PoE devices at the distance up to 100 meters through the 4-pair Cat 5/5e UTP wire.

Equipped with console and Web interface, the Web Smart Ethernet Switch can be programmed for basic Switch management functions such as port speed configuration, Port Trunking, VLAN, Port Mirroring, QoS, bandwidth control, Misc Configuration.

2.1.1 Product Overview

The PLANET FGSW-2402PVS/FGSW-2620PVS are Web Smart Ethernet Switches with 24 RJ-45 10/100Mbps ports. The Switch also provides up to two 100Mbps or 1000Mbps fiber ports, and two 10/100Mbps TP or 1000Base-T ports for cost effective high-performance network connectivity. With its 8.8Gbps non-blocking switch fabric, the PLANET Switch can also provide a local, high bandwidth, Fast Ethernet network for your departmental backbone plus the ability to trunk four ports (800Mbps) to enable switch-to-switch backbone. The advanced functionality of the Switch eliminates traditional problems associated with the use of Ethernet. Users can be segregated using built-in VLAN functionality. These, coupled with the flexible fiber module options, make the Switch one of the best and most cost-effective MTU switch solutions for Multi-tenant service providers.

Complied IEEE802.3af standards, the switch support full 48VDC power for any remote IEEE802.3af powered device (PD) like Wireless LAN Access Point, IP phone, and LAN Camera. Supporting power supply of 260 watts, FGSW-2402PVS/FGSW-2620PVS provides sufficient power to the 24 remote devices.

This product also supports store-and-forward forwarding scheme to ensure low latency and high data integrity, eliminates unnecessary traffic and relieves congestion on critical network paths. With an intelligent address recognition algorithm, Switch could recognize up to 6K different MAC address and enables filtering and forwarding at full wire speed.

2.1.2 FGSW-2402PVS/FGSW-2620PVS Front Panel

Figure 2-1 shows front panel of FGSW-2402PVS.

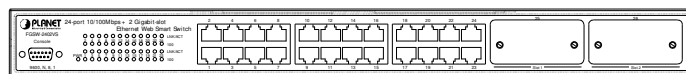

Figure 2-1 PLANET FGSW-2402PVS Front Panel

Figure 2-2 shows front panel of FGSW-2620PVS.

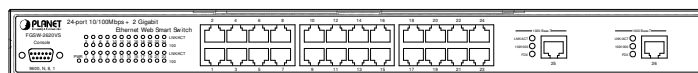

Figure 2-2 PLANET FGSW-2620PVS Front Panel

2.1.3 LED Indicators

System

LED	Color	Function
PWR	Green	Lit: Power on

Per 10/100Mbps port

LED	Color	Function
LNK/ACT	Green	Lit: indicate the link through that port is successfully established. Blink: indicate that the switch is actively sending or receiving data over that port.
100	Orange	Lit: indicate that the port is operating at 100Mbps. Off: indicate that the port is operating at 10Mbps.
PoE In-use	Green	Lit: indicate that the port is providing 48VDC to remote Powered Device

Per 10/100/1000Mbps port (FGSW-2620PVS only)

LED	Color	Function
LNK/ACT	Green	Lit: indicate the link through that port is successfully established. Blink: indicate that the switch is actively sending or receiving data over that port.
100/1000	Green / Orange	Orange: indicate that the port is operating at 1000Mbps. Green: indicate that the port is operating at 100Mbps.
FDX/COL	Green	Lit: indicate that port is operating in full-duplex mode. Off: indicate that port is operating in half-duplex mode. Blink: if a collision is detected when the port is in half-Duplex mode.

2.1.4 Extension Slots

The extension slots #25 and #26 of FGSW-2402PVS can be a 10/100Base-TX, 1000Base-T or 100Base-FX, 1000Base-SX/LX switching port as the extension module installed.

Please refer to the **section 3.2.4 Port Configuration** for the detailed installation and settings.

2.1.5 FGSW-2402PVS/FGSW-2620PVS Rear Panel

The rear panel of the Switch indicates an AC inlet power socket, which accepts input power from 100 to 240VAC, 50-60Hz. Figure 2-3 shows Rear panel of the Switch.



Figure 2-3 Rear Panel of FGSW-2402PVS/FGSW-2620PVS

Power Notice:

1. The device is a power-required device, it means, it will not work till it is powered. If your networks should active all the time, please consider using UPS (Uninterrupted Power Supply) for your device. It will prevent you from network data loss or network downtime.
2. In some area, installing a surge suppression device may also help to protect your Switch from being damaged by unregulated surge or current to the Switch or the power adapter.

2.2 Installing FGSW-2402PVS/FGSW-2620PVS

This part describes how to install your Web Smart Ethernet Switch and make connections to the Switch. Please read the following topics and perform the procedures in the order being presented.

To install your Switch on a desktop or shelf, simply complete the following steps.

2.2.1 Desktop Installation

To install a Switch on a desktop or shelf, simply complete the following steps:

Step1: Attach the rubber feet to the recessed areas on the bottom of the Switch.

Step2: Place the Switch on a desktop or shelf near an AC power source.

Step3: Keep enough ventilation space between the Switch and the surrounding objects

Note: When choosing a location, please keep in mind the environmental restrictions discussed in Chapter 1, Section 4, Specification.

Step4: Connect your Switch to network devices

- A. Connect one end of a standard network cable to the 10/100 RJ-45 ports on the front of the Switch.
- B. Connect the other end of the cable to the network devices such as printer servers, workstations or routers...etc.

Note: Connection to the Switch requires UTP Category 5 network cabling with RJ-45 tips. For more information, please see the Cabling Specification in **Appendix A**.

Step5: **Supply power to the Switch.**

- A. Connect one end of the power cable to the Switch
- B. Connect the power plug of the power cable to a standard wall outlet then power on the Switch.

When the Switch receives power, the Power LED should remain solid Green.

2.2.2 Rack Mounting

To install the Switch in a **19-inch** standard rack, follow the instructions described below.

Step1: Place your Switch on a hard flat surface, with the front panel positioned towards your front side.

Step2: Attach a rack-mount bracket to each side of the Switch with supplied screws attached to the package. Figure 2-4 shows how to attach brackets to one side of the Switch.

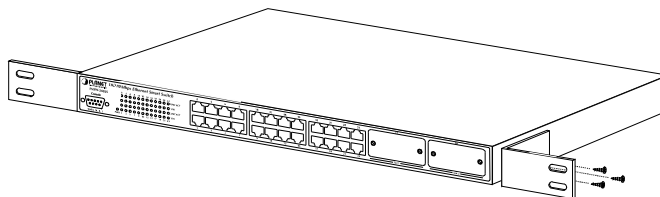

Figure 2-4 Attaching the brackets to the Switch

Caution: You must use the screws supplied with the mounting brackets. Damage caused to the parts by using incorrect screws would invalidate your warranty.

Step3: Secure the brackets tightly.

Step4: Follow the same steps to attach the second bracket to the opposite side.

Step5: After the brackets are attached to the Switch, use suitable screws to securely attach the brackets to the rack, as shown in figure 2-5.

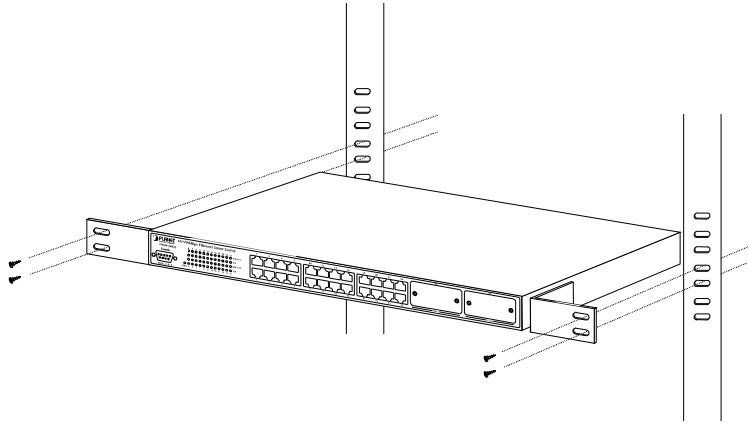

Figure 2-5 Mounting the Switch in a Rack

Step6: Proceed with the steps 4 and steps 5 of section **2.2.1 Desktop Installation** to connect the network cabling and supply power to your Switch.

3. CONSOLE CONFIGURATION

Unlike the unmanaged switch, FGSW-2402PVS/ FGSW-2620PVS performs series smart functions that make the Switch operate more effectively. This section will describe the common usage of the Switch Smart Configuration.

Note: The following section will base on the console screens of FGSW-2620PVS, for FGSW-2402PVS the display will be the same to FGSW-2620PVS.

3.1 Preparing for configuration

3.1.1 Connecting a PC or Terminal to the RS-232 Port

When you are ready to configure the smart functions of the Switch, make sure you had connected the supplied RS-232 serial cable to the RS-232 port at the front panel of your Switch and your PC.

3.1.2 Terminal Emulation Setup Program

In Windows 98/2000/XP, launch "HyperTerminal", create a new connection, and adjust settings as below:

- Emulation: VT-100 compatible
- Baud per second: 9600
- Data bits: 8
- Parity: None
- Stop bits: 1
- Flow Control: None

To get a demonstration, please see the figure 3-1.

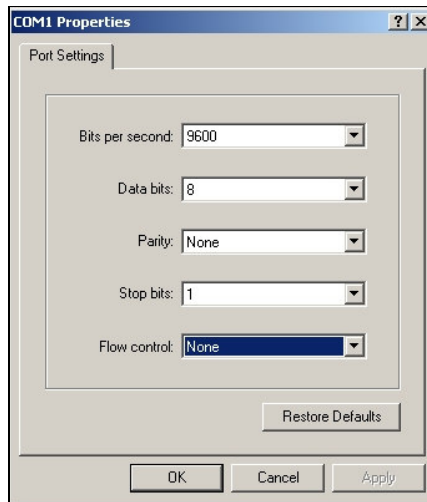

Figure 3-1 Console Port Settings for smart functions

3.1.3 Power-up Self-test Status

As the Switch powers on, it goes through a self-test process to ensure proper operations of the Switch hardware. The messages will be displayed to show the test progress. When the test completes successfully, the system will display a login screen. If any of the components fails during the test, you may need to contact your local dealer and have the Switch replaced. Figure 3-2 shows a successful Self-test menu of the Power-up System Self-diagnostic Process.

```

System Diagnosing:
Switch Register R/W Test ... PASS
Phy Register R/W Test ... PASS
SRAM Built_In_Self_Test ... PASS
EEPROM R/W Test ... PASS
EEPROM Content Check ... PASS
Initializing user configuration ... _

```

Figure 3-2 Power-up System Self-diagnostic screen

3.1.4 Login

After the self-test completes successfully, the screen in figure 3-3 appears. Login is required to access the console interface. The factory default username is "**admin**" without password. You may change it in the **Misc Configuration**. To access to the Main Menu, please always enter the correct username and password.

```

Welcome to PLANET FGSW-2620PVS
Ethernet Web Smart Switch

Username : admin
Password :

Copyright 2005 (c) PLANET Technology Corp. Rev 1.0

```

Figure 3-3 Switch Console Login screen

3.2 Getting Started

3.2.1 General Guidelines

Switch allows users to configure the device via menu screens. To work within the menu, please follow the guidelines shown in Table 3-1.

Item	Description
Value 0-9	Choose one item from the console screen.
TAB KEY	Choose next item from the console screen.
Arrows KEY	↑ ↓ ← → means up, down, left, right .
BACKSPACE	Back to previous item from the console screen.
ENTER KEY	Access the highlighted item from the console screen.
SPACE KEY	When a List item is performed, the Space key starts the selection and scrolls through the available choices.
ESC	Return to the actions menu.

Table 3-1 General Guideline within the Menu

3.2.2 Main Menu Screen

The main menu enables you to view and manage the Switch settings. Use the "**Tab**" keys to move the highlight over a selection. Press "**Enter**" key for chooses Smart function of Switch. After entering into any smart function screen, choose **<Edit>** for configuring. Then Press the "**Space Bar**" to toggle back and forth between the options. After setup completed, press "**ESC**" key to return to Actions menu and use the "**TAB**" key to choose the **<Save>** for save the current configuration. You can also choose each function through press the value 0-9 on your keyboard. Please refer to figure 3-4 for available options on main menu.



Figure 3-4 Main Menu Screen

1. Port Status

Display the port status, which allow you to view the port disable/enable status, current link status, speed/duplex mode, flow control status. Explained in **section 3.2.3**.

2. Port Configuration

Allow user to disable/enable each port, Auto-negotiation disable/enable on each port, per port 10/100Mbps full and half duplex mode selection. Flow control disable/enable on each port. Explained in **section 3.2.4**.

3. Trunk Configuration

Allow user to enable the trunk function and configure. Explained in **section 3.2.5**.

4. VLAN Configuration

Allow user to enable the port-based VLAN function and configure. Explained in **section 3.2.6**.

5. Port Mirroring Configuration

Allow user to enable the port mirroring function and configure. Explained in **section 3.2.7**.

6. QoS Configuration

Allow user to enable the QoS function and configure. Explained in **section 3.2.8**.

7. Bandwidth Control

Allow user to enable the bandwidth control function and configure. Explained in **section 3.2.9**.

8. Misc Configuration

Allow user to configure the advanced function. Explained in **section 3.2.10**.

9. PoE Configuration

Allow user to configure the Power over Ethernet function. Explained in **section 3.2.11**.

0. Logout

Allow user to logout the Switch console interface. Explained in **section 3.2.12**.

3.2.3 Port Status

Press **1** on your keyboard or use the **"TAB"** key to move the highlight to the **Port Status** and press **"Enter"** to access the screen of **Port Status** from the **Main Menu screen** (please see the figure3-4). The screen of **Port Status** in figure 3-5 appears. Table 3-2 describes the **Port Status** objects of Switch. This menu allows you to view the port status of the Switch.

Port	Enable	Link	Spd/Dplx	Flow Ctrl	Port	Enable	Link	Spd/Dplx	Flow Ctrl
PORT1	Enable	Down	----	---	PORT15	Enable	Down	----	---
PORT2	Enable	Down	----	---	PORT16	Enable	Down	----	---
PORT3	Enable	Down	----	---	PORT17	Enable	Down	----	---
PORT4	Enable	Down	----	---	PORT18	Enable	Down	----	---
PORT5	Enable	Down	----	---	PORT19	Enable	Down	----	---
PORT6	Enable	Down	----	---	PORT20	Enable	Down	----	---
PORT7	Enable	Down	----	---	PORT21	Enable	Down	----	---
PORT8	Enable	Down	----	---	PORT22	Enable	Down	----	---
PORT9	Enable	Down	----	---	PORT23	Enable	Down	----	---
PORT10	Enable	Down	----	---	PORT24	Enable	Down	----	---
PORT11	Enable	Down	----	---	PORT25	Enable	Down	----	---
PORT12	Enable	Down	----	---	PORT26	Enable	Down	----	---
PORT13	Enable	Down	----	---					
PORT14	Enable	Up	100F	0n					

Figure 3-5 Port Status Screen

Object	Description
Port	Indicate port 1 to port 24, and 2-module slot.
Enable	Display disable or enable on each port.
Link	Display current link status on each port.
Spd/Dpx	Display current speed duplex mode on each port.
Flow Ctrl	Display current flow control status on each port.

Table 3-2 Descriptions of the Port Status screen Objects

3.2.4 Port Configuration

Press **2** on your keyboard or use the **"TAB"** key to move the highlight to the **Port Configuration** and press **"Enter"** to access the screen of **Port Configuration** from the **Main Menu screen** (please see the figure3-4).

The screen of **Port Configuration** in figure 3-6 appears. Table 3-3 describes the **Port Configuration** objects. This menu allows you to change the port configuration of the Switch. The user can disable/enable each port and determine each port's auto-negotiation, mode, speed, duplex mode, flow control. Use the **"TAB"** key to choose the **<Edit>** then press **"Enter"**. Then start to modify these settings. Use the **"TAB"** key to move the highlight to the object and press the **"Space Bar"** key to toggle back and forth between the options. After setup completed, press **"ESC"** key to return to Actions menu and use the **"TAB"** key to choose the **<Save>** for saving the current configuration.

Port	Enable	Auto	Spd/Dpx	Flow Ctrl	Port	Enable	Auto	Spd/Dpx	Flow Ctrl
PORT1	Enable	Off	100F	On	PORT15	Enable	On	Auto	On
PORT2	Enable	On	Auto	On	PORT16	Enable	On	Auto	On
PORT3	Enable	On	Auto	On	PORT17	Enable	On	Auto	On
PORT4	Enable	On	Auto	On	PORT18	Enable	On	Auto	On
PORT5	Enable	On	Auto	On	PORT19	Enable	On	Auto	On
PORT6	Enable	On	Auto	On	PORT20	Enable	On	Auto	On
PORT7	Enable	On	Auto	On	PORT21	Enable	On	Auto	On
PORT8	Enable	On	Auto	On	PORT22	Enable	On	Auto	On
PORT9	Enable	On	Auto	On	PORT23	Enable	On	Auto	On
PORT10	Enable	On	Auto	On	PORT24	Enable	On	Auto	On
PORT11	Enable	On	Auto	On					
PORT12	Enable	On	Auto	On					
PORT13	Enable	On	Auto	On	PORT25	Enable	On	Auto	On
PORT14	Enable	On	Auto	On	PORT26	Enable	On	Auto	On

Actions-> <Quit> <Edit> <Save>
 ArrowKey/TAB/BACK=Move SPACE=Toggle ENTER=Select ESC=Back

Figure 3-6 Port Configuration Screen

Object	Description
Port	Indicate port 1 to port 24, and 2-module slot.
Enable	Allow user to disable or enable each port.
Auto	Allow user to disable or enable Auto negotiation feature on each port.
Spd/Dpx	Allow user to change the speed duplex mode on each port.
Flow Ctrl	Allow user to disable or enable flow control on each port.

Table 3-3 Descriptions of the Port Configuration Screen Objects

Due to the hardware restriction, port #25/ port # 26 of the Switch does not allow to configure the speed and duplex mode. The operation of the two ports will base on the table below.

Module-slot / Port #25, #26	Module / Port Type	Speed / Duplex
MII-TP	100Base-TX; RJ-45	Auto-negotiation
MII-GT / FGSW-2620PVS	10/100/100Base-T; RJ-45	Auto-negotiation
MII-SC / MII-Sxx ^{*1}	100Base-FX; SC	Force 100 Full-duplex mode
MII-ST	100Base-FX; ST	Force 100 Full-duplex mode
MII-SA20/SB20	100Base-FX; Single SC	Force 100 Full-duplex mode
MII-SX	1000Base-SX; SC	Force 1000 Full-duplex mode
MII-LX; MII-Lxx ^{*1}	1000Base-LX; SC	Force 1000 Full-duplex mode

Table 3-4 Operation of MII-series module

Note:

1. xx represents the maximum fiber-optic distance, for example MII-L40 for 40kilometers. For the available models, please consult your local dealer for the available modules.
2. For fiber module/interface, please also check the link partner is set to forced full-duplex for the connection.

3.2.5 Trunk Configuration

Press **3** on your keyboard or use the **"TAB"** key to move the highlight to the **Trunk Configuration** and press **"Enter"** to access the screen of **Trunk Configuration** from the **Main Menu screen** (please see the figure3-4).

The screen of **Trunk Configuration** in figure 3-7 appears. Table 3-5 shows the descriptions of the **Trunk Configuration** screen Objects. The Port Trunking Configuration menu controls the port trunking or the so-called Link Aggregation function. There are 7 Trunk groups in the Switch can be bundled together to form a high-speed trunk. Use the **"TAB"** key to choose the **<Edit>** and press **"Enter"**. Then start to modify these settings. Use the **"TAB"** key to move the highlight to the selection and press the **"Space Bar"** key to toggle back and forth between the options. After setup completed, press **"ESC"** key to return to Actions menu and use the **"TAB"** key to choose the **<Save>** for saving the current configuration.

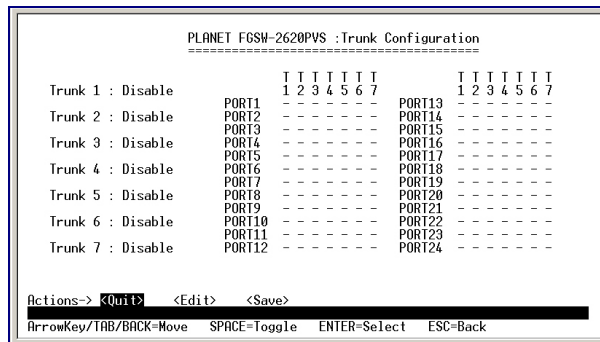

Figure 3-7 Trunk Configuration Screen

Object	Description
Trunk 1 to Trunk 7	Allow user to disable or enable trunk function in Trunk 1 to Trunk 7 groups.
Trunk Groups 1-7	From port 1 to port 24. Allow user to assign maximum 4 ports of each Trunk group.

Table 3-5 Descriptions of the Trunk Configuration screen Objects

3.2.6 VLAN Configure

Press **4** on your keyboard or use the **"TAB"** key to move the highlight to the **VLAN Configuration** and press **"Enter"** to access the screen of **VLAN Configuration** from the **Main Menu screen** (please see the figure3-4).

The screen of **VLAN Configuration** in figure 3-8 appears. Table 3-6 shows the descriptions of the **VLAN Configuration** Menu Objects.

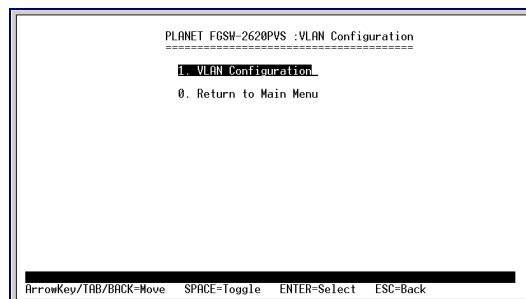

Figure 3-8 VLAN Configure screen

Object	Description
VLAN Configuration	Allow user to disable/enable the Port-based VLAN function. The available options are shown as below: Disabled: disable VLAN function of the Switch. PortBased: enable port-based VLAN function of the Switch. The available group ID from 1 to 255.
Return to Main Menu	Back to Main Menu screen.

Table 3-6 Descriptions of the VLAN Configuration screen Objects

3.2.6.1 Create a Port-Based VLAN Group

Choose “**PortBased**” from the VLAN mode of **VLAN Configure**. The screen in figure 3-9 appears with message “**Press SPACE to select and ENTER to set mode**”. Please press “**Enter**” to continue. The following screen in figure 3-10 appears with message “**Change mode will clear original VLAN setting! Continue? [Y/N]**”. Please press “**Y**” then the following screens in figure 3-11 & 3-12 appears.

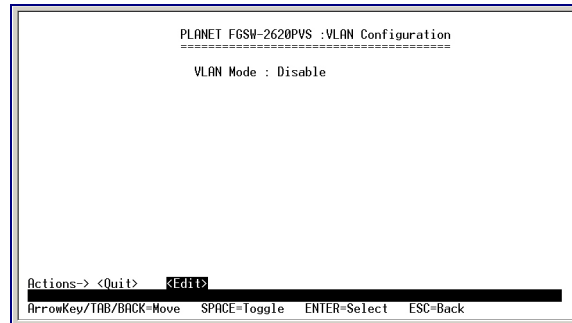

Figure 3-9 Create a port-based VLAN Group screen

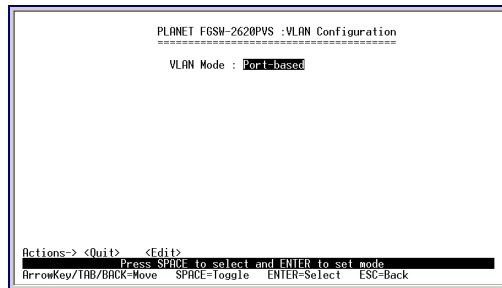

Figure 3-10 Create a port-based VLAN Group screen

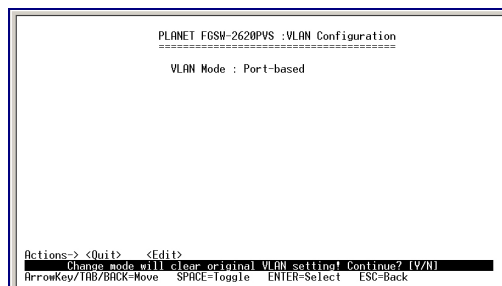

Figure 3-11 Create a port-based VLAN Group screen

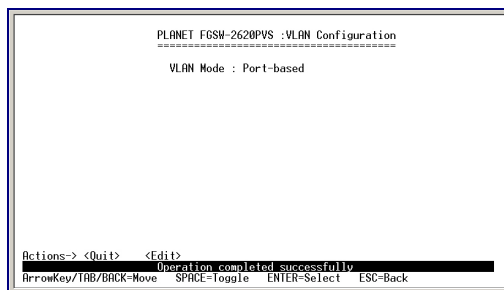

Figure 3-12 Create a port-based VLAN Group screen

Press “**Enter**” then the following screen in figure 3-13 appears.

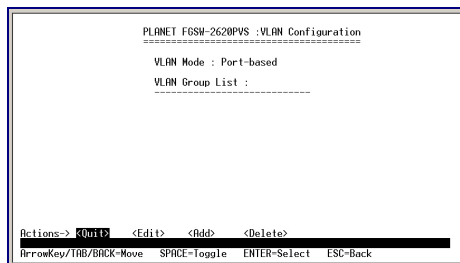

Figure 3-13 Create a port-based VLAN Group screen

Use the “**TAB**” key to move the highlight to the **Add** and press “**Enter**” to access the screen of **Add a PortBased VLAN Group**. Use the “**TAB**” key to move the highlight to the **<Edit>** and press “**Enter**” to modify these settings. Use the “**TAB**” key to move the highlight to the selection and press the “**Space Bar**” key to toggle back and forth between the options.

The screen of **Add a PortBased VLAN Group** in figure 3-14 appears. After setup completed, press “**ESC**” key to return to Actions menu and use the “**TAB**” key to choose the **<Save>** for saving the current configuration. The screen in figure 3-15 appears.

Note: The Switch support up to 26 port-based VLAN groups. And the group ID is 1-255.

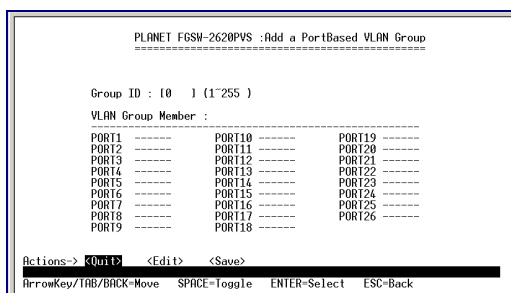

Figure 3-14 Create a port-based VLAN Group screen

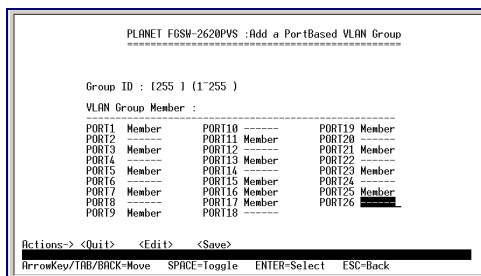

Figure 3-15 Create a port-based VLAN Group Successfully screen

Press “**Enter**” for back to the VLAN Configuration screen. The screen in figure 3-16 appears.

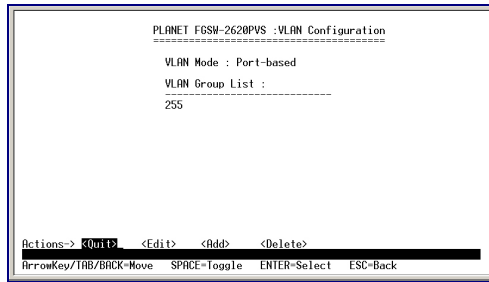

Figure 3-16 Create a port-based VLAN Group completed screen

3.2.6.2 Edit a VLAN Group

Use the "TAB" key to move the highlight to the <Edit> and press "Enter" to start editing the existence VLAN group. The screen in figure 3-17 appears.

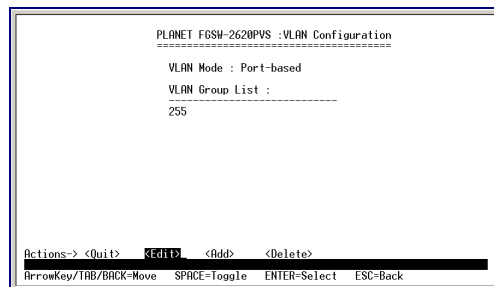

Figure 3-17 Edit existence VLAN Group Configuration Screen

Use the "Tab" and "Back space" to move forth and back between VLAN and press "Enter" to select the VLAN you want to edit. The screen in figure 3-18 appears. Please follow the same procedure as section 3.2.6.1 create a port-based VLAN Group to edit the VLAN group.

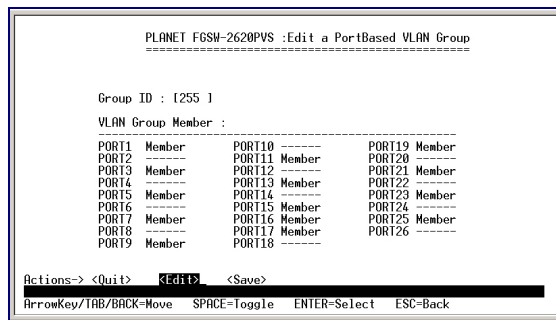

Figure 3-18 Edit existence VLAN Group Configuration Screen

After editing is completed, press "ESC" key to return to Actions menu and use the "TAB" key to choose the <Save> for saving the current configuration. The screen in figure 3-19 appears with message "Operation completed successfully"

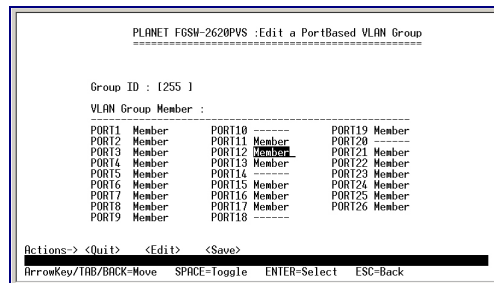

Figure 3-19 Save VLAN Configuration successfully screen

3.2.6.3 Delete a VLAN Group

Use the "TAB" key to move the highlight to the <Delete> and press "Enter" to start the deleting of existence VLAN group. The screen of Delete a VLAN Group in figure 3-20 appears.

```
PLANET F6SH-2620PVS :VLAN Configuration
=====
VLAN Mode : Port-based
VLAN Group List :
-----
255

Actions-> <Quit>  <Edit>  <Add>  <Delete>
Press ENTER to edit/delete group
ArrowKey/TAB/BACK=Move  SPACE=Toggle  ENTER=Select  ESC=Back
```

Figure 3-20 Delete existence VLAN group Screen

Use "TAB" or "Backspace" key to move the highlight to the VLAN you want to delete and press "Enter" to delete the VLAN. The screen similar to figure 3-21 appears with message " Press Enter to edit/delete group".

```
PLANET F6SH-2620PVS :VLAN Configuration
=====
VLAN Mode : Port-based
VLAN Group List :
-----
255

Actions-> <Quit>  <Edit>  <Add>  <Delete>
Press ENTER to edit/delete group
ArrowKey/TAB/BACK=Move  SPACE=Toggle  ENTER=Select  ESC=Back
```

Figure 3-21 Delete existence VLAN Group Screen

After press Enter, The screen similar to figure 3-22 appears with message "Continue deleting? [Y/N]"

```
PLANET F6SH-2620PVS :VLAN Configuration
=====
VLAN Mode : Port-based
VLAN Group List :
-----
255

Actions-> <Quit>  <Edit>  <Add>  <Delete>
Continue deleting? [Y/N]
ArrowKey/TAB/BACK=Move  SPACE=Toggle  ENTER=Select  ESC=Back
```

Figure 3-22 Delete existence VLAN Group Screen

After press "Y". The screen similar to figure 3-23 appears with message " Operation completed successfully!"

```
PLANET F6SH-2620PVS :VLAN Configuration
=====
VLAN Mode : Port-based
VLAN Group List :
-----
255

Actions-> <Quit>  <Edit>  <Add>  <Delete>
Operation completed successfully
ArrowKey/TAB/BACK=Move  SPACE=Toggle  ENTER=Select  ESC=Back
```

Figure 3-23 Delete existence VLAN Group successfully Screen

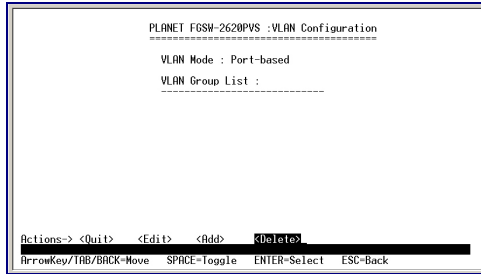

Figure 3-24 Delete existence VLAN Group successfully Screen

3.2.6.4 Return to Main Menu

Choose “Return to Main Menu” to return to **Main Menu** screen of the Switch. The screen in figure 3-25 appears.

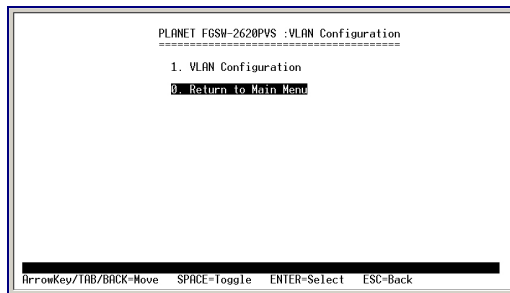

Figure 3-25 Return to Main Menu Screen

3.2.7 Port Mirroring Configuration

Press 5 on your keyboard or use the "TAB" key to move the highlight to the **Port Mirroring Configuration** and press “Enter” to access the screen of **Port Mirroring Configuration** from the **Main Menu** screen (please see the figure 3-4). Table 3-7 shows the descriptions of the **Port Mirroring Configuration** screen Objects.

The **Port Mirroring Configuration** provides Disable, RX, TX, RX&TX selection from Port Monitoring mode. Use the "TAB" key to choose the <Edit>, then start to modify these settings. Use the "TAB" key to move the highlight to the selection and press the "Space Bar" key to toggle back and forth between the options. The screen of **Port Mirroring Configuration** in figure 3-26 appears.

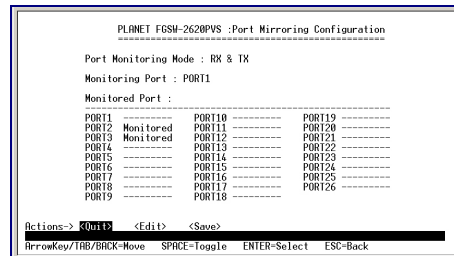

Figure 3-26 Port Mirroring Configuration Screen

Object	Description
Port Monitoring Mode	The available options are shown as below: Disable: port mirroring function disable. RX: this mode will duplicate the data from Monitored port and forward to the Monitoring port. TX: this mode will duplicate the data that send to the Monitored port and forward to the Monitoring port. RX&TX: this mode will duplicate the data send and receive from the Monitored port. Forward to the Monitoring port with 1:1 ratio.

Monitoring Port	Allow seeing all monitor port traffic; you can connect Monitoring port to LAN Explorer, Session Wall, Sniffer Pro or Netxray.
Monitored Port	Choose one or more specific port for monitor the traffic of RX and TX or both (RX and TX) from Monitoring port.

Table 3-7 Descriptions of the Port Mirroring Configuration Screen Objects

After setup is completed. Press "**ESC**" key to return to Actions menu and use the "**TAB**" key to choose the **<Save>** for saving the current configuration. The screen in figure 3-27 appears with message "**Operation completed successfully!**"

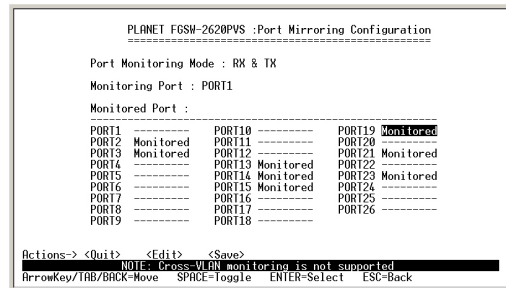

Figure 3-27 Port Mirroring Configuration save successfully screen

3.2.8 QoS Configuration

Press **6** on your keyboard or use the "**TAB**" key to move the highlight to the **QoS Configuration** and press "**Enter**" to access the screen of **QoS Configuration** from the **Main Menu screen** (please see the figure 3-4). Table 3-8 shows the descriptions of the **QoS Configuration** screen Objects.

The **QoS Configuration** provide Disable, QoS Priority, High: Low=3:1,High: Low= 5:1, High: Low=7:1, High empty then Low selection from QoS mode. Use the "**TAB**" key to choose the **<Edit>**, then start to modify these settings. Use the "**TAB**" key to move the highlight to the selection and press the "**Space Bar**" key to toggle back and forth between the options. The screen of **QoS Configuration** in figure 3-28 appears.

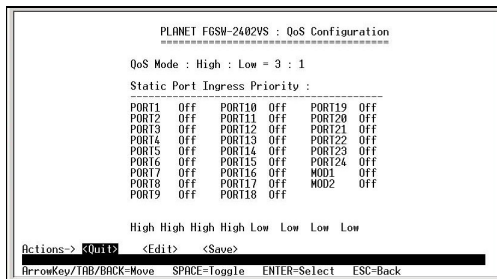

Figure 3-28 QoS Configuration screen

Object	Description
QoS Mode	The available options are shown as below: High: Low=3:1: the packet output ration of high priority and low priority is 3 to 1. High: Low=5:1: the packet output ration of high priority and low priority is 5 to 1. High: Low=7:1: the packet output ration of high priority and low priority is 7 to 1. High empty then Low: forward the packets with high priority first then packets with low priority. Disable QoS Priority: disable QoS priority function.
Static Port Ingress Priority	The available options are shown as below: Off: the packets come from the specific port without any priority. Low: the packets come from the specific port with low priority. High: the packets come from the specific port with High priority.
802.1p priority	802.1p priority=7:0: allow assign high and low on each priority.

Table 3-8 Descriptions of the QoS Configuration Screen Objects

After setup is completed. Press "ESC" key to return to Actions menu and use the "TAB" key to choose the <Save> for saving the current configuration. The screen in figure 3-29 appears with message "Operation completed successfully!"

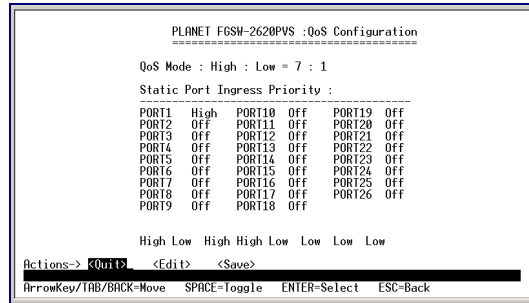

Figure 3-29 QoS Configuration save successfully screen

3.2.9 Bandwidth Control

Press 7 on your keyboard or use the "TAB" key to move the highlight to the **Bandwidth control** and press "Enter" to access the screen of **Bandwidth control** from the **Main Menu screen** (please see the figure 3-4). Table 3-9 shows the descriptions of the **Bandwidth control** screen Objects. Use the "TAB" key to choose the <Edit>, then start to modify these settings. The screen of **Bandwidth control** in figure 3-30 appears.

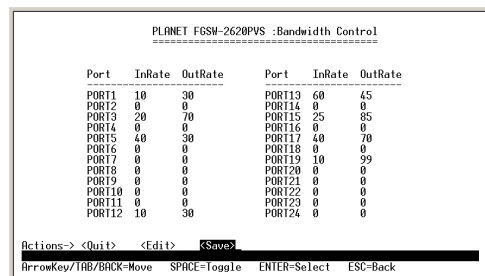

Figure 3-30 Bandwidth Control setting Screen

Object	Description
Port	Indicate port 1 to port 24
InRate	Allow user to input the value of packet rate sent from the connected port to this port. You must enable the flow control feature of this port for the function to work normally. The available value ranges from 1 to 99.
OutRate	Allow user to input the value of packet rate sent from this port to the connected port. The available value ranges from 1 to 99.

Table 3-9 Descriptions of the Switch Information screen Objects

After setup is completed. Press "ESC" key to return to Actions menu and use the "TAB" key to choose the <Save> for saving the current configuration. The screen in figure 3-31 appears with message "Operation completed successfully!"

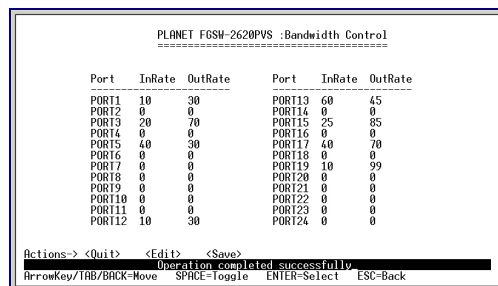

Figure 3-31 Bandwidth Control save successfully Screen

3.2.10 Misc Configuration

Press **8** on your keyboard or use the **"TAB"** key to move the highlight to the **Misc Configuration** and press **"Enter"** to access the screen of **Misc Configuration** from the **Main Menu** screen (please see the figure 3-4). Table 3-10 shows the descriptions of the **Misc Configuration** screen Objects. The screen of **Misc Configuration** in figure 3-32 appears.

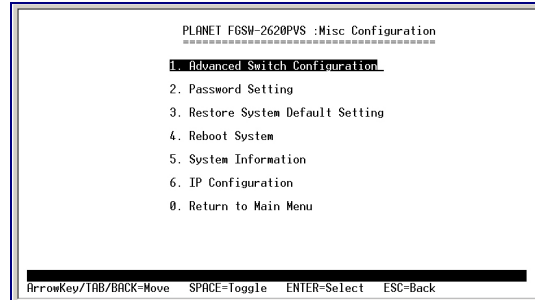

Figure 3-32 Misc Configuration Screen

Object	Description
Advanced Switch Configuration	Allow user to configure the advanced Switch configuration. Please refer to chapter 3.2.10.1.
Password Setting	Allow user to disable or enable password protection. Set the username and password, Maximum up to 8 characters. Please refer to chapter 3.2.10.2.
Reset System Default Setting	Allow user to reset the Switch to default mode. Please refer to chapter 3.2.10.3.
Reboot System	Allow user to reboot the Switch. Please refer to chapter 3.2.10.4.
System Information	Display the firmware and web page version. Please refer to chapter 3.2.10.5.
IP Configuration	Allow user to set the IP address, subnet mask and Default gateway. Please refer to chapter 3.2.10.6.
Return to Main Menu	Allow return to the Console Main Menu. Please refer to chapter 3.2.10.7.

Table 3-10 Descriptions of the Switch Information screen Objects

3.2.10.1 Advanced Switch Configuration

Press **1** on your keyboard or use the **"TAB"** key to move the highlight to the **Advanced Switch Configuration** and press **"Enter"** to access the screen of **Advanced Switch Configuration** from the **Misc Configuration** screen (please see the figure 3-32).

Table 3-11 shows the descriptions of the **Advanced Switch Configuration** screen Objects. Use the **"TAB"** key to choose the **<Edit>**, then start to modify these settings. The screen of **Advanced Switch Configuration** in figure 3-33 appears.

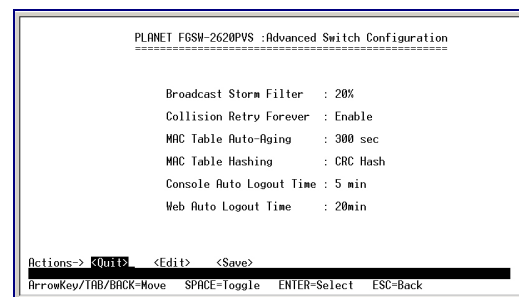

Figure 3-33 Advanced Switch Configuration Screen

Object	Description
Broadcast Storm Filter	If this function enable, the Switch will limitation the broadcast packets. The available options are Off, 5%, 10%, 20%.
Collision Retry Forever	If this function is disabled, when a packet meet a collision, the switch will retry 6 times before discard the packets. Otherwise, the switch will retry until the packet is successfully sent.
MAC Table Auto-Aging	Allow user to set the aging time of the MAC address table. The available options are Disable, 150 sec, 300 sec, 600 sec. The default is 300sec.
MAC Table Hashing	The available options are CRC Hash and Direct Map.
Console Auto Logout Time	Allow user to set the Auto logout time of console interface. The available options are Never, 5min, 10min, 20min.
Web Auto Logout Time	Allow user to set the Auto logout time of web interface. The available options are 5min, 10min, and 20min.

Table 3-11 Descriptions of the Advanced Switch Configuration screen Objects

After setup is completed. Press "**ESC**" key to return to Actions menu and use the "**TAB**" key to choose the **<Save>** for saving the current configuration. The screen in figure 3-34 appears with message "**Operation completed successfully!**"



Figure 3-34 Misc Configuration save successfully Screen

3.2.10.2 Password Setting

Press **2** on your keyboard or use the "**TAB**" key to move the highlight to the **Password Setting** and press "**Enter**" to access the screen of **Password Setting** from the **Misc Configuration screen** (please see the figure 3-32).

Table 3-12 shows the descriptions of the **Password Setting** screen Objects. Use the "**TAB**" key to choose the **<Edit>**, then start to modify these settings. The screen of **Password Setting** in figure 3-35 appears.



Figure 3-35 Password Setting Screen

Object	Description
Password protection	Allow user to disable or enable the password request of the console and Web interface.
User Name	Allow user to modify the login user name. Up to 8 characters.
New Password	Allow user to modify the login password. Up to 8 characters.
Password Again	Input the password again for confirm.

Table 3-12 Descriptions of the Password Setting screen Objects

After setup is completed. Press "**ESC**" key to return to Actions menu and use the "**TAB**" key to choose the **<Save>** for saving the current configuration.

The screen in figure 3-36 appears with message "**Operation completed successfully!**"

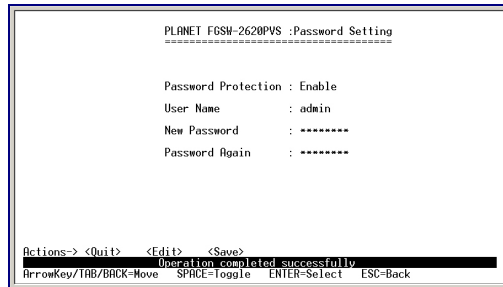

Figure 3-36 Password Setting save successfully Screen

3.2.10.3 Reset System Default Setting

Press **3** on your keyboard or use the "**TAB**" key to move the highlight to the **Reset System Default Setting** and press "**Enter**" from the **Misc Configuration** screen (please see the figure 3-32).

The screen in figure 3-37 appears with message "**All user configuration will be reset to default! Continue? [Y/N]**". Press "**Y**" then the screen in figure 3-38 appears.

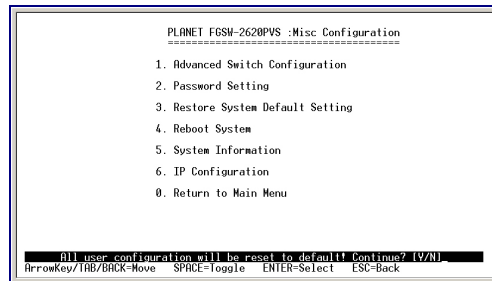

Figure 3-37 Reset System Default Setting Screen

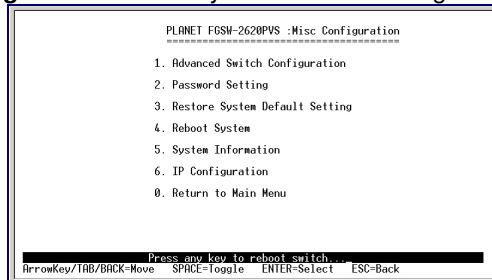

Figure 3-38 Reset System Default Setting Screen

Then the Switch will reboot, the screen in figure 3-39 appears. After power on completed, then the login screen of Switch in figure 3-40 appears.

```
System Diagnosing:
Switch Register R/W Test ... PASS
Phy Register R/W Test ... PASS
SRAM Built_In_Self_Test ... PASS
EEPROM R/W Test ... PASS
EEPROM Content Check ... PASS
Initializing user configuration ... _
```

Figure 3-39 Reboot Switch Screen

```

Welcome to PLANET FGSW-2620PVS
Ethernet Web Smart Switch

Username : admin
Password :

Copyright 2005 (c) PLANET Technology Corp. Rev 1.0
```

Figure 3-40 Switch Console Login Screen

3.2.10.4 Reboot System

Press **4** on your keyboard or use the **"TAB"** key to move the highlight to the **Reboot System** and press **"Enter"** from the **Misc Configuration** screen (please see the figure 3-32).

The screen in figure 3-41 appears with message **"Reboot now? [Y/N]"**. Press **"Y"** then the Switch will reboot, the screen in figure 3-42 appears. After power on completed, then the login screen of Switch in figure 3-43 appears.

```
PLANET FGSW-2620PVS :Misc Configuration
*****
1. Advanced Switch Configuration
2. Password Setting
3. Restore System Default Setting
4. Reboot System
5. System Information
6. IP Configuration
0. Return to Main Menu

Reboot now? [Y/N]
ArrowKey/TAB/BACK=Move SPACE=Toggle ENTER=Select ESC=Back
```

Figure 3-41 Reboot System Screen

```
System Diagnosing:
Switch Register R/W Test ... PASS
Phy Register R/W Test ... PASS
SRAM Built_In_Self_Test ... PASS
EEPROM R/W Test ... PASS
EEPROM Content Check ... PASS
Initializing user configuration ... _
```

Figure 3-42 Switch Reboot Screen

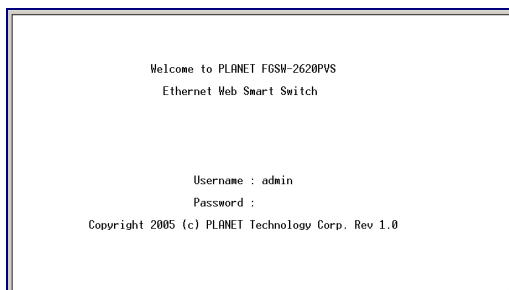

Figure 3-43 Switch Console Login Screen

3.2.10.5 System Information

Press **5** on your keyboard or use the **"TAB"** key to move the highlight to the **System Information** and press **"Enter"** from the **Misc Configuration** screen (please see the figure 3-32). The screen in figure 3-44 appears.

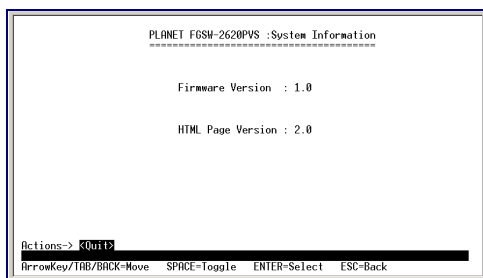

Figure 3-44 System Information Screen

3.2.10.6 IP Configuration

Press **6** on your keyboard or use the **"TAB"** key to move the highlight to the **IP Configuration** and press **"Enter"** from the **Misc Configuration** screen (please see the figure 3-32).

Table 3-13 shows the descriptions of the **IP Configuration** screen Objects. Use the **"TAB"** key to choose the **<Edit>**, then start to modify these settings. The screen of **IP Configuration** in figure 3-45 appears.

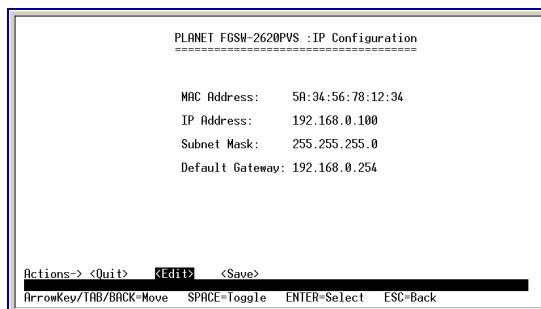

Figure 3-45 IP Configuration Screen

Object	Description
MAC Address	Display the MAC address of the Switch. This MAC address is not allowed to modify.
IP address	Allow user to modify the IP address of the Switch. The default IP address is 192.168.0.100
Subnet Mask	Allow user to modify the Subnet Mask of the Switch.
Default Gateway	Allow user to modify the default gateway of the Switch.

Table 3-13 Descriptions of the IP Configuration screen Objects

After setup is completed. Press "ESC" key to return to Actions menu and use the "TAB" key to choose the <Save> for saving the current configuration. The screen in figure 3-46 appears with message "Operation completed successfully!"

```

PLANET FGSW-2620PVS :IP Configuration
=====
MAC Address: 58:34:56:78:12:34
IP Address: 192.168.0.100
Subnet Mask: 255.255.255.0
Default Gateway: 192.168.0.254

Actions-> <Quit> <Edit> <Save>
Operation completed successfully
ArrowKey/TAB/BACK=Move SPACE=Toggle ENTER=Select ESC=Back
    
```

Figure 3-46 IP Configuration Screen

3.2.10.7 Return to Main Menu

This function allows user to return to the main menu of Switch. The screen in figure 3-47 appears. Then the main menu in screen figure3-48 appears.

```

PLANET FGSW-2620PVS :Misc Configuration
=====
1. Advanced Switch Configuration
2. Password Setting
3. Restore System Default Setting
4. Reboot System
5. System Information
6. IP Configuration
9. Return to Main Menu

ArrowKey/TAB/BACK=Move SPACE=Toggle ENTER=Select ESC=Back
    
```

Figure 3-47 Return to Main Menu Screen

```

PLANET FGSW-2620PVS :Main Menu
=====
1. Port Status
2. Port Configuration
3. Trunk Configuration
4. VLAN Configuration
5. Port Mirroring Configuration
6. QoS Configuration
7. Bandwidth Control
8. Misc Configuration
9. POE Configuration
0. Logout

ArrowKey/TAB/BACK=Move SPACE=Toggle ENTER=Select ESC=Back
    
```

Figure 3-48 Main Menu Screen

3.2.11 PoE Configuration

Press 9 on your keyboard or use the "TAB" key to move the highlight to the **POE Configuration** and press "Enter" to access the screen of **POE Configuration** from the **Main Menu** screen (please see the figure 3-4). Table 3-14 shows the descriptions of the **POE Configuration** screen Objects. The screen of **POE Configuration** in figure 3-49 appears.

```

PLANET FGSW-2620PVS :POE Configuration
=====
1. POE Ports Config
2. POE Port Status
0. Return to Main Menu

ArrowKey/TAB/BACK=Move SPACE=Toggle ENTER=Select ESC=Back
    
```

Figure 3-49 POE Configuration Screen

Object	Description
POE Ports Config	Allow user to configure the POE function and power provision priority. Please refer to chapter 3.2.11.1.
POE Port Status	Allow user to check the POE PD power usages. Please refer to chapter 3.2.11.2.
Return to Main Menu	Allow return to the Console Main Menu. Please refer to chapter 3.2.11.3.

Table 3-14 Descriptions of the Switch Information screen Objects

3.2.11.1 Advanced Switch Configuration

Press **1** on your keyboard or use the **"TAB"** key to move the highlight to the **POE Ports Config** and press **"Enter"** to access the screen of **POE Ports Config** from the **POE Configuration screen** (please see the figure 3-49).

Table 3-14 shows the descriptions of the **POE Ports Config** screen Objects. Use the **"TAB"** key to choose the **<Edit>**, then start to modify these settings. The screen of **POE Ports Config** in figure 3-50 appears.

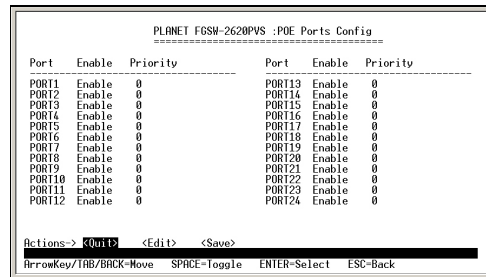

Figure 3-50 PoE Ports Config Screen

Object	Description
Port	List the port number for configuration.
Enable	Allow user to Enable / Disable POE function.
Priority	Allow user to set the POE power provision priority. The priority range is from 0 to 11, in which the 0 is the highest and the 11 is the lowest.

Table 3-15 Descriptions of the POE Ports Config screen Objects

After setup is completed. Press **"ESC"** key to return to Actions menu and use the **"TAB"** key to choose the **<Save>** for saving the current configuration. The screen in figure 3-51 appears with message **"Operation completed successfully!"**

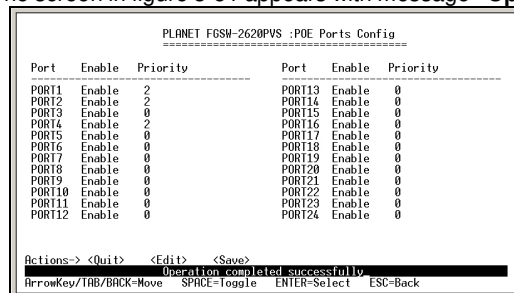

Figure 3-51 POE Ports Config save successfully Screen.

3.2.11.2 POE Port Status

Press **2** on your keyboard or use the **"TAB"** key to move the highlight to the **POE Port Status** and press **"Enter"** to access the screen of **POE Port Status** from the **POE Configuration screen** (please see the figure 3-52).

Table 3-16 shows the descriptions of the **POE Port Status** screen Objects. Use the **"TAB"** key to choose the **<Refresh>**, then the system will refresh the port status on screen.

Object	Description
Port	List the port number for configuration.
Enable	List each port POE power provision setting.
Power [W]	List each connected device power usage.
Current [mA]	List each connected device current usage.

Table 3-16 Descriptions of the POE Port Status screen Objects

3.2.11.3 Return to Main Menu

This function allows user to return to the main menu of Switch. The screen in figure 3-52 appears. Then the main menu in screen figure3-53 appears.

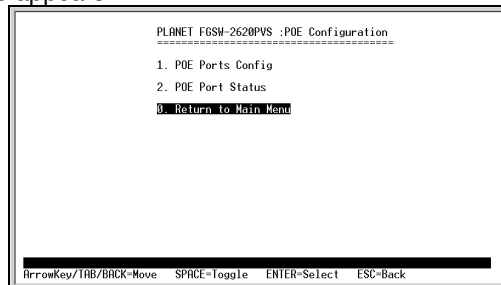

Figure 3-52 Return to Main Menu Screen



Figure 3-53 Main Menu Screen

3.2.12 Logout

Press **0** on your keyboard or use the **"TAB"** key to move the highlight to the **Logout** and press **"Enter"** from the **Main Menu screen** (please see the figure 3-4). The Switch Console Login screen in figure 3-49 appears.

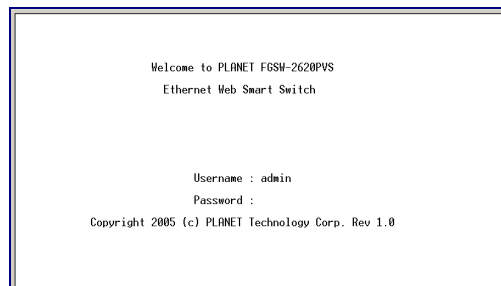

Figure 3-54 Switch Console Login Screen

4. WEB CONFIGURATION

The Web Smart Ethernet Switch provides a Web interface for Switch Smart function configuration. Since the Switch can be configured through the Web Browser, a network administrator can manage and monitor the Switch from the local LAN or from the Internet. Before login the Web interface of Switch, please setup the “**IP Address**” with local serial console port (RS232 port) and use this IP address to configure Switch through the **Web** interface. Or modify your PC’s IP domain to the same with Switch then use the default IP address to remote configure Switch through the Web interface.

4.1 Login in to the Switch

Before you start configure the Switch, please note the Switch is configured through an Ethernet connection, make sure the manager PC must be set on same the **IP subnet address**. For example, the default IP address of the Switch is **192.168.0.100**, then the manager PC should be set at 192.168.0.x (where x is a number between 1 and 254, except 100), and the default subnet mask is 255.255.255.0. Use Internet Explorer 5.0 or above Web browser. Enter IP address **<http://192.168.0.100>** (the factory-default IP address) to access the Web interface. The login screen in figure 4-1 appears.



Figure 4-1 Web login Screen

Note: the default mode is username “**admin**” without password.

4.2 Main Menu

After entering the username and password, the main screen appears as figure 4-2.



Figure 4-2 Web Main Menu Screen

The smart functions are shown on the left of the browser window and they are:

Port Status:

Display the port status, which allow to viewing the port disable/enable status, current link status, and speed/duplex mode, flow control status. Explained on **section 4.3**

Port Configuration:

Allow user to disable/enable each port, Auto-negotiation disable/enable on each port, per port 10/100Mbps full and half duplex mode selection. Flow control disable/enable on each port. Explained on **section 4.4**

Trunk Configuration:

Allow user to enable the trunk function and configure. Explained in **section 4.5**

VLAN Configuration:

Allow user to enable the port-based VLAN function and configure. Explained in **section 4.6**

Port Mirroring Configuration:

Allow user to enable the port mirroring function and configure. Explained in **section 4.7**

QoS Configuration:

Allow user to enable the QoS function and configure. Explained in **section 4.8**

Bandwidth Control:

Allow user to enable the bandwidth control function and configure. Explained in **section 4.9**

Misc Configuration:

Allow user to configure the advanced function. Explained in **section 4.10**

POE Configuration

Allow user to configure the POE function. Explained in **section 4.11**

Logout:

Allow user to logout the Switch Web interface. Explained in **section 4.12**

4.3 Port Status

This menu displays each port's status of the Switch. The Port Status in the screen will includes each port's disable / enable and current link status, connection speed duplex mode and flow control status. The screen is as like figure 4-3 below.

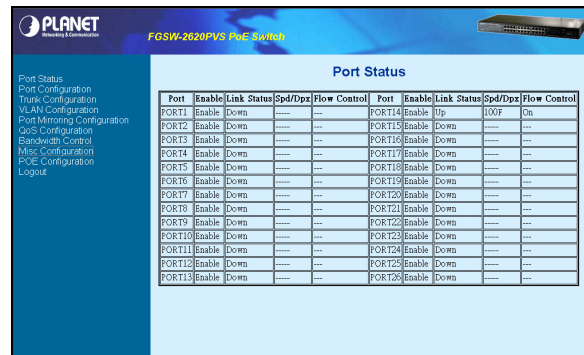

Port	Enable	Link Status	Spd/Dplx	Flow Control	Port	Enable	Link Status	Spd/Dplx	Flow Control
PORT1	Enable	Down	----	---	PORT14	Enable	Up	100F	On
PORT2	Enable	Down	----	---	PORT15	Enable	Down	----	---
PORT3	Enable	Down	----	---	PORT16	Enable	Down	----	---
PORT4	Enable	Down	----	---	PORT17	Enable	Down	----	---
PORT5	Enable	Down	----	---	PORT18	Enable	Down	----	---
PORT6	Enable	Down	----	---	PORT19	Enable	Down	----	---
PORT7	Enable	Down	----	---	PORT20	Enable	Down	----	---
PORT8	Enable	Down	----	---	PORT21	Enable	Down	----	---
PORT9	Enable	Down	----	---	PORT22	Enable	Down	----	---
PORT10	Enable	Down	----	---	PORT23	Enable	Down	----	---
PORT11	Enable	Down	----	---	PORT24	Enable	Down	----	---
PORT12	Enable	Down	----	---	PORT25	Enable	Down	----	---
PORT13	Enable	Down	----	---	PORT26	Enable	Down	----	---

Figure 4-3 Port Status Screen

You can also click on the refresh button of your browser to get the latest status of the Switch.

4.4 Port Configuration

This menu allows to setting port disable/ enable, Auto-negotiation disable/ enable, and speed duplex mode selection, flow control disable/ enable of each port. The screen is as figure 4-4.

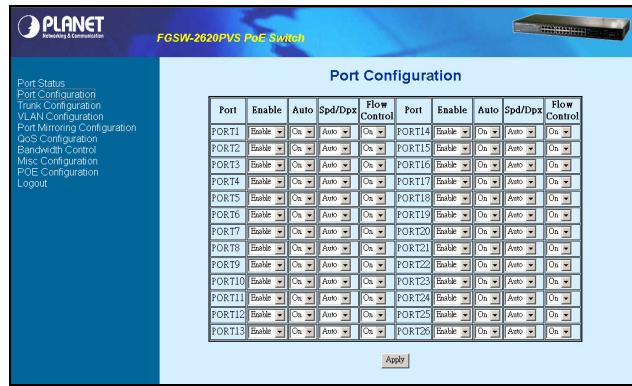

Figure 4-4 Port Configuration Screen

After setup is completed. Press "Apply" button for save the current configuration. The screen figure 4- 5 appears with message "Operation completed successfully!"

Please be reminded, the operation of port#25, port#26 will base on the setting in table 3-4.

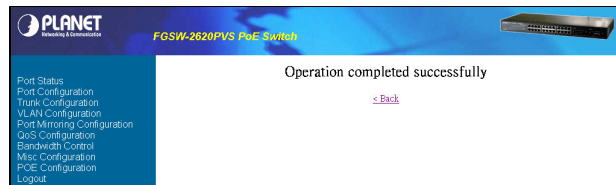

Figure 4-5 Port Configuration save successfully Screen

Press "Back" for back to previous web screen.

4.5 Trunk Configuration

This function allows to configuring the trunk function. It provide up to 7 trunk groups and each trunk for up to maximum 4-ports. The screen in figure 4-6 appears.



Figure 4-6 Trunk Configuration Screen

After setup is completed. Press "Apply" button for save the current configuration. The screen in figure 4- 7 appears with message "Operation completed successfully!"

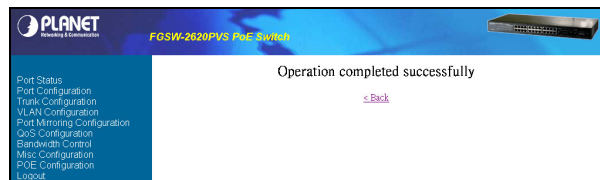

Figure 4-7 Trunk Configuration save successfully Screen

Press "Back" for back to previous web screen.

4.6 VLAN Configuration

This function allows to enabling the port-based VLAN function. The screen in figure 4-8 appears.

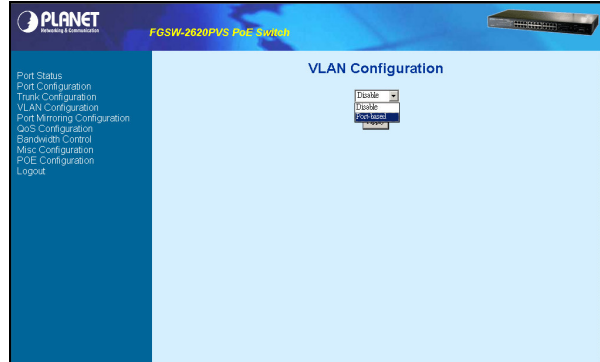

Figure 4-8 VLAN Configuration Screen

After setup is completed. Press "**Apply**" button for enable the port-based VLAN. The screen in figure 4-9 appears

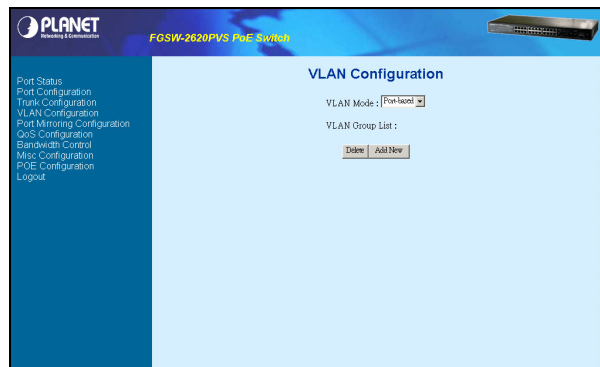

Figure 4-9 VLAN Configuration Screen

Press "**Add NEW**" to create a new port-based VLAN group. The screen in figure 4-10 appears.

Note: Up to 26 port-based VLAN groups can be added and the group ID range is 1-255.

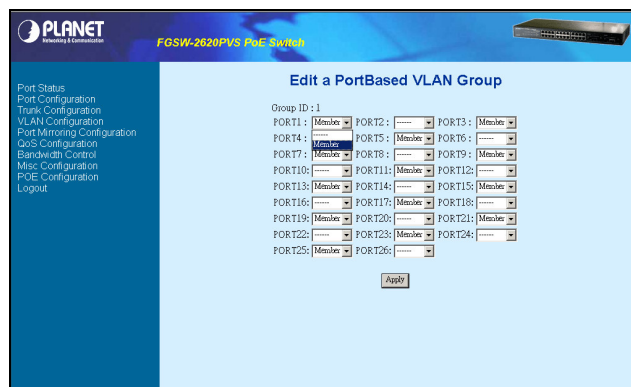

Figure 4-10 VLAN Configuration Screen

After setup is completed. Press "**Apply**" button for save the current configuration. The screen in figure 4- 11 appears with message "**Operation completed successfully!**"

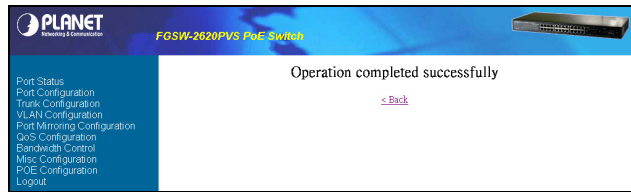

Figure 4-11 VLAN Configuration save successfully Screen

Press “**Back**” for back to previous web screen. It also support delete the existence VLAN group by press “**Delete**” button from VLAN Configure screen (figure 4-9).

4.7 Port Mirroring Configuration

This function allows to enabling the port mirroring function. Table 4-1 shows the descriptions of the **Port Mirroring Configuration** screen Objects.

Object	Description
Disable	Disable port mirroring function.
RX	This mode will duplicate the data from Monitored port and forward to the Monitoring port.
TX	This mode will duplicate the data that send to the Monitored port and forward to the Monitoring port.
RX & TX	This mode will duplicate the data send and receive from the Monitored port. Forward to the Monitoring port with 1:1 ratio.

Table 4-1 Descriptions of the **Port Mirroring Configuration** screen Objects.

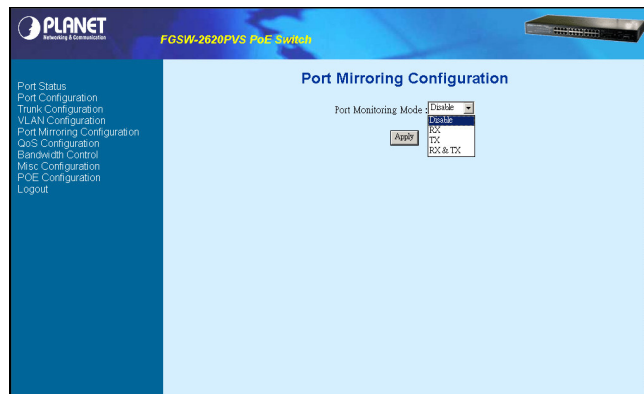

Figure 4-12 Port Mirroring Configuration Screen

After choose one port-monitoring mode. Press “**Apply**” button for enable the port mirroring function. The screen in figure 4-13 appears

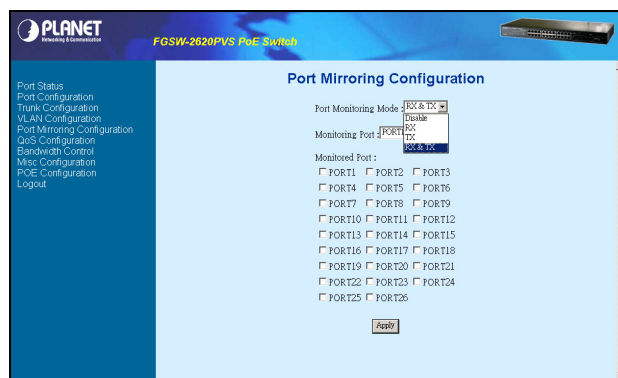

Figure 4-13 Port Mirroring Configuration Screen

After setup is completed. Press “**Apply**” button for save the current configuration. The screen in figure 4- 14 appears with message “**Operation completed successfully!**”

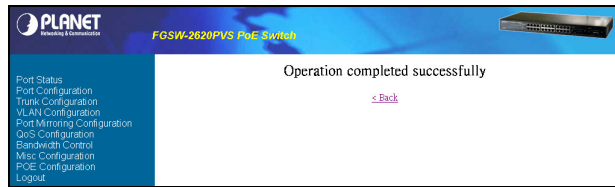

Figure 4-14 Port Mirroring Configuration save successfully Screen

Press “Back” for back to previous web screen.

4.8 QoS Configuration

This function allows enabling the QoS function. Table 4-2 shows the descriptions of the **QoS Configuration** screen Objects.

Object	Description
Disable QoS Priority	Disable QoS priority function.
High empty then Low	Forward the packets with high priority first then packets with low priority.
High: Low=3:1	The packet output ration of high priority and low priority is 3 to 1.
High: Low=5:1	The packet output ration of high priority and low priority is 5 to 1.
High: Low=7:1	The packet output ration of high priority and low priority is 7 to 1.
802.1p priority=7:0	Allow assign high and low on each priority. The screens in figure 4-15& 4-16& 4-17 appear.

Table 4-2 Descriptions of the **QoS Configuration** screen Objects.

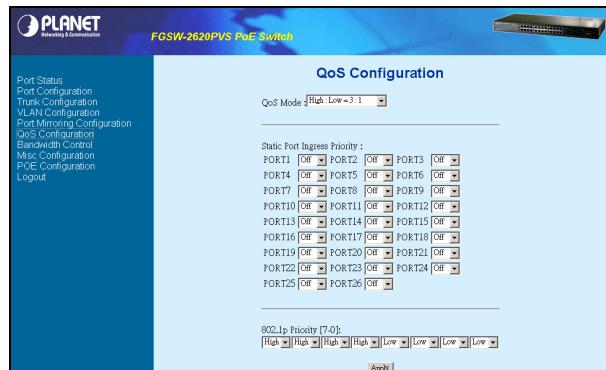

Figure 4-15 QoS Configuration Screen

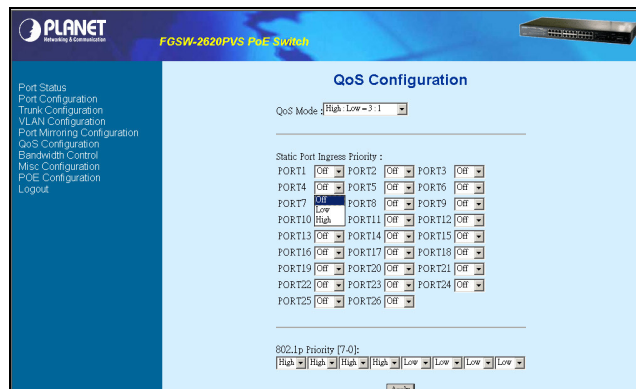

Figure 4-16 QoS Configuration Screen

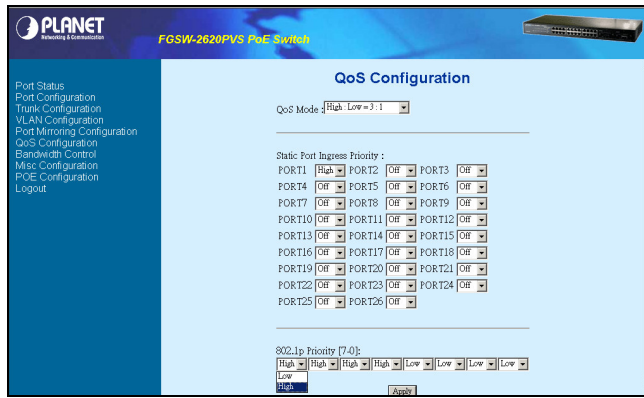

Figure 4-17 QoS Configuration Screen

After setup is completed. Press "**Apply**" button for save the current configuration. The screen in figure 4-18 appears with message "**Operation completed successfully!**"

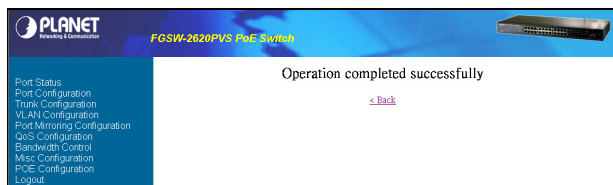

Figure 4-18 QoS Configuration save successfully Screen

Press "**Back**" for back to previous web screen.

4.9 Bandwidth Control

This function allow to set bandwidth on each port. Table 4-3 shows the descriptions of the **Bandwidth Control** screen Objects.

Object	Description
InRate	Allow user to input the value of packet rate sent from the connected port to this port. You must enable the flow control feature of this port for the function to work normally. The available value ranges from 1 to 99.
OutRate	Allow user to input the value of packet rate sent from this port to the connected port. The available value ranges from 1 to 99.

Table 4-3 Descriptions of the **Bandwidth Control** screen Objects.

The screen in figure 4-19 appears.

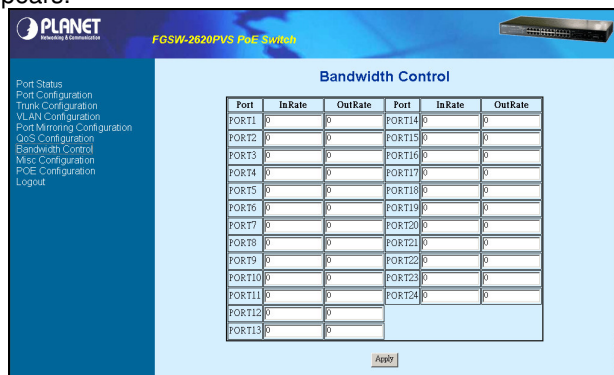

Figure 4-19 Bandwidth Control setting Screen

After setup is completed. Press "**Apply**" button for save the current configuration. The screen in figure 4-20 appears with message "**Operation completed successfully!**"

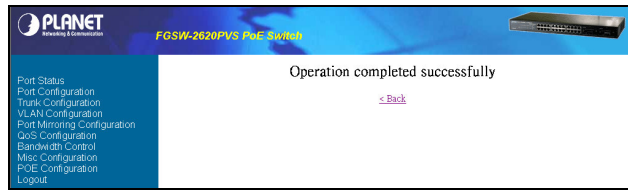

Figure 4-20 Bandwidth Control save successfully Screen

Press “**Back**” for back to previous web screen.

4.10 Misc Configuration

This function provides the advanced configuration of the Switch. The available options are shown as below:

Advanced Switch Configuration:

Allow user to configure the advanced Switch configuration. Please refer to **section 4.10.1**.

Password Setting:

Allow user to disable or enable password protection. Set the username and password, Maximum up to 8 characters. Please refer to **section 4.10.2**.

Reset System Default Setting:

Allow user to reset the Switch to default mode. Please refer to **section 4.10.3**.

Reboot System:

Allow user to reboot the Switch. Please refer to **section 4.10.4**.

System Information:

Display the firmware and web page version. Please refer to **section 4.10.5**.

IP Configuration:

Allow user to set the IP address, subnet mask and Default gateway. Please refer to **section 4.10.6**.

Return to Main Menu:

Allow return to the Console Main Menu. Please refer to **section 4.10.7**.

The screen in figure 4-21 appears.

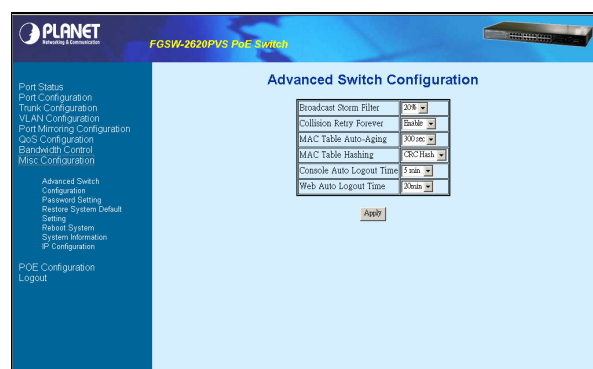

Figure 4-21 Misc Configuration Screen

4.10.1 Advanced Switch Configuration

The available options are shown as below:

Broadcast Strom Filter:

If this function enable, the Switch will limitation the broadcast packets. The available options are **off, 5%, 10%, and 20%**. The screen in figure 4-22 appears.

Broadcast Storm Filter	20%
Collision Retry Forever	Off
MAC Table Auto-Aging	10%
MAC Table Hashing	CRC Hash
Console Auto Logout Time	5 min
Web Auto Logout Time	20min

Figure 4-22 Broadcast Storm Filter Screen

Collision Retry Forever:

If this function is disabled, when a packet meet a collision, the switch will retry 6 times before discard the packets. Otherwise, the switch will retry until the packet is successfully sent. The screen in figure 4-23 appears.

Broadcast Storm Filter	20%
Collision Retry Forever	Disable
MAC Table Auto-Aging	Disable
MAC Table Hashing	CRC Hash
Console Auto Logout Time	5 min
Web Auto Logout Time	20min

Figure 4-23 Collision Retry Forever Screen

MAC Table Auto-Aging:

Allow user to set the aging time of the MAC address table. The available options are **Disable, 150 sec, 300 sec, 600 sec**. The default is 300sec. The screen in figure 4-24 appears.

Broadcast Storm Filter	20%
Collision Retry Forever	Disable
MAC Table Auto-Aging	300 sec
MAC Table Hashing	Disable
Console Auto Logout Time	300 sec
Web Auto Logout Time	20min

Figure 4-24 MAC Table Auto-Aging Screen

MAC Table Hashing:

The available options are **CRC Hash and Direct Map**. The screen in figure 4-25 appears.

Broadcast Storm Filter	20%
Collision Retry Forever	Disable
MAC Table Auto-Aging	300 sec
MAC Table Hashing	CRC Hash
Console Auto Logout Time	CRC Hash
Web Auto Logout Time	20min

Figure 4-25 MAC Table Hashing Screen

Console Auto Logout Time:

Allow user to set the Auto logout time of console interface. The available options are **Never, 5min, 10min, 20min**. The screen in figure 4-26 appears.

Broadcast Storm Filter	20%
Collision Retry Forever	Disable
MAC Table Auto-Aging	300 sec
MAC Table Hashing	CRC Hash
Console Auto Logout Time	5 min
Web Auto Logout Time	Never
	5 min
	10min
	20min
Apply	

Figure 4-26 Console Auto Logout Time Screen

Web Auto Logout Time:

Allow user to set the Auto logout time of web interface. The available options are **5min, 10min, and 20min**. The screen in figure 4-27 appears.

Broadcast Storm Filter	20%
Collision Retry Forever	Disable
MAC Table Auto-Aging	300 sec
MAC Table Hashing	CRC Hash
Console Auto Logout Time	5 min
Web Auto Logout Time	20min
	5 min
	10min
	20min
Apply	

Figure 4-27 Web Auto Logout Time Screen

After setup is completed. Press "**Apply**" button for save the current configuration. The screen in figure 4-28 appears with message "**Operation completed successfully!**"

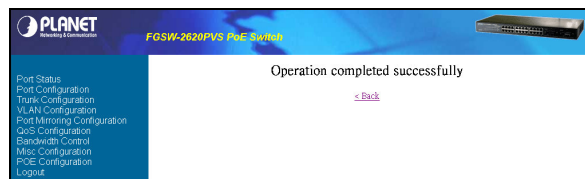

Figure 4-28 Advanced Switch Configuration save successfully Screen

Press "**Back**" for back to previous web screen.

4.10.2 Password Setting

This function allows to disable/enable the password protection. Table 4-4 shows the descriptions of the **Password Setting** screen Objects.

Object	Description
Password protection	Allow user to disable or enable the password request of the console and Web interface.
User Name	Allow user to modify the login user name. Up to 8 characters.
New Password	Allow user to modify the login password. Up to 8 characters.
Password Again	Input the password again for confirm.

Table 4-4 Descriptions of the **Password Setting** screen Objects.

The screen in figure 4-29 appears.

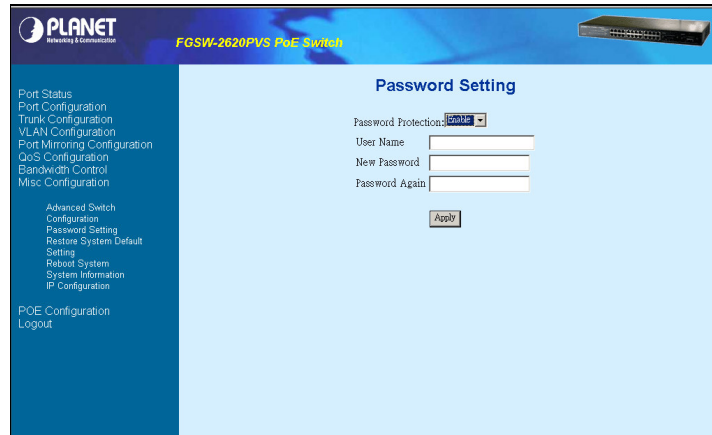

Figure 4-29 Password Setting Screen

If disable the password protection. Then the following screen appears.

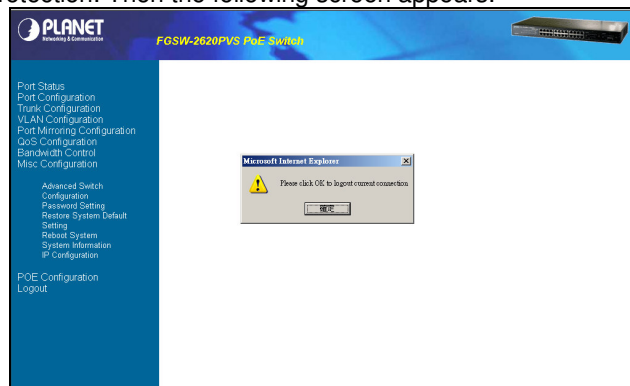

Figure 4-30 Password Setting Screen

Press, "OK" for logout the Switch. Then can enter into the web interface of the Switch without any username and password request.

If enable the password protection. Then the following screen appears.

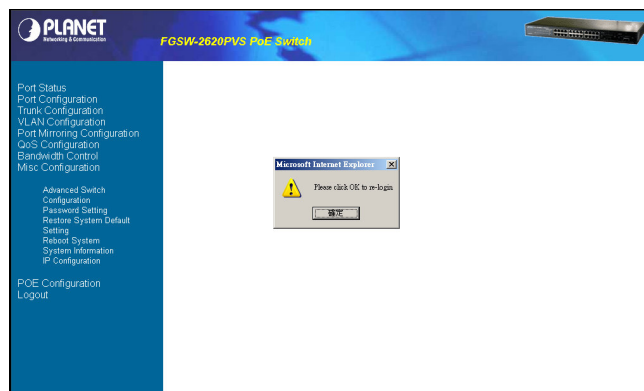

Figure 4-31 Password Setting Screen

Press, "OK" for re-login the Switch. Then enter into the web interface of the Switch with username and password request. And also can modify the username and password.

After setup is completed. Press "Apply" button for save the current configuration. The screen in figure 4-32 appears with message "Operation completed successfully!"

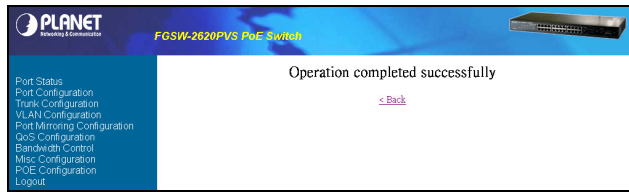

Figure 4-32 Password Setting save successfully Screen

Press “**Back**” for back to previous web screen.

4.10.3 Reset System Default Setting

This function allows resetting the Switch to default mode. The screen in figure 4-33 appears. Press “**OK**” then the Switch will reboot for the default mode.



Figure 4-33 Reset System Default Setting Screen

4.10.4 Reboot System

This function allows rebooting the Switch. The screen in figure 4-34 appears. Press “**OK**” then the Switch will reboot.



Figure 4-34 Reboot System Screen

4.10.5 System Information

This function allows viewing the system information of the Switch.

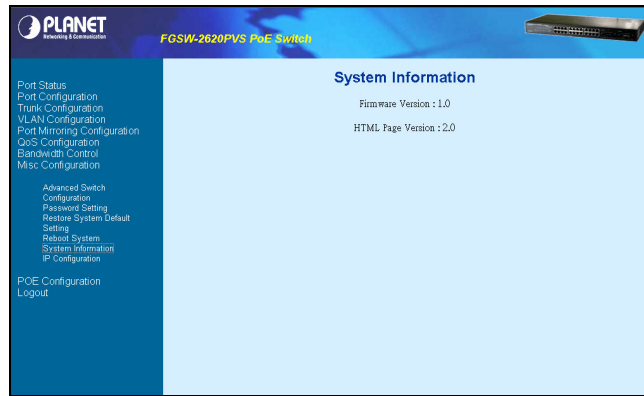

Figure 4-35 System Information Screen

4.10.6 IP Configuration

This function allows modifying the IP address, subnet mask and default gateway. The screen in figure 4-36 appears.

Note: The default IP address is 192.168.0.100

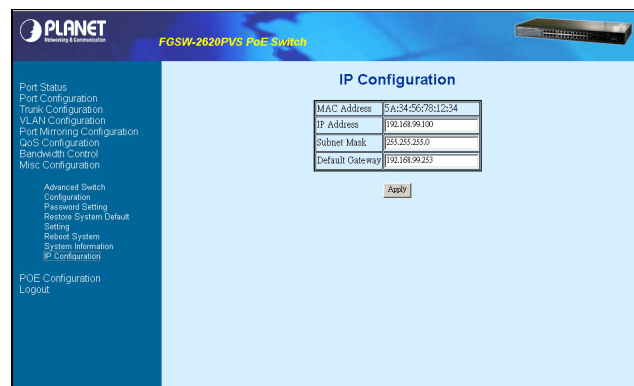

Figure 4-36 IP Configuration Screen

After setup is completed. Press "**Apply**" button for save the current configuration. The screen in figure 4-37 appears with message "**Operation completed successfully!**"

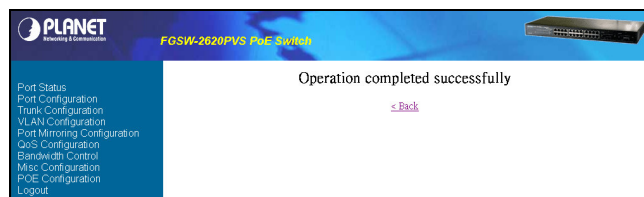

Figure 4-37 IP Configuration save successfully Screen

Press "**Back**" for back to previous web screen.

4.11 PoE Configuration

This function provides the Power over Ethernet configuration of the Switch. The available options are shown as below:

POE Ports

Allow user to Enable/Disable POE function and set port power feeding priority. Please refer to **section 4.11.1**.

POE Port Status:

Allow user to check the port Power over Ethernet settings and the connected power usage. Please refer to section 4.11.2.

4.11.1 POE Ports

This function allows Enable/Disable POE function and set port power feeding priority. The screen in figure 4-38 appears.

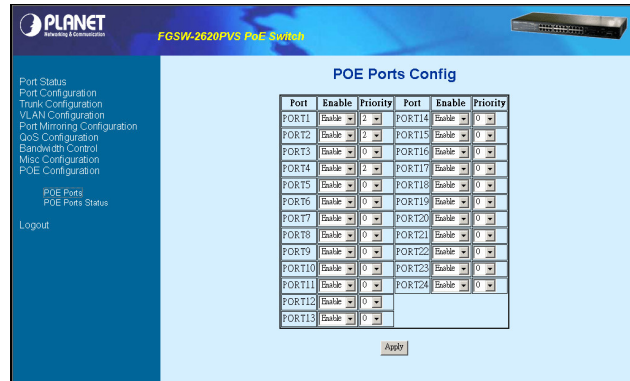

Figure 4-38 POE Configuration Screen

After setup is completed. Press "Apply" button for save the current configuration. The screen in figure 4-39 appears with message "Operation completed successfully!"

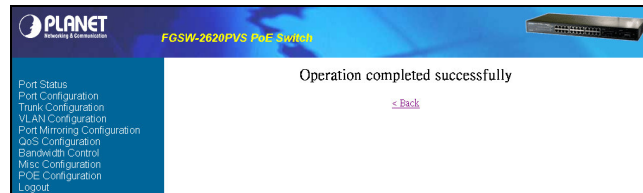

Figure 4-39 POE Ports Configuration save successfully Screen

Press "Back" for back to previous web screen.

4.11.2 PoE Ports Status

This function allows users to check the port Power over Ethernet settings and the connected power usage. The screen in figure 4-40 appears.

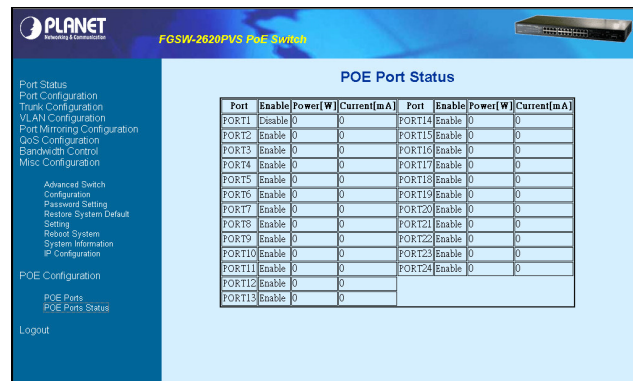

Figure 4-40 POE Ports Status Screen

4.12 Logout

This function allows to logout the web interface of the Switch. The screen in figure 4-41 appears. Press “OK” then the web login screen in figure 4-42 appears.



Figure 4-41 Logout successfully Screen



Figure 4-42 Web login Screen

5. SWITCH OPERATION

5.1 Address Table

The Switch is implemented with an address table. This address table composed of many entries. Each entry is used to store the address information of some node in network, including MAC address, port no, etc. This information comes from the learning process of Ethernet Switch.

5.2 Learning

When one packet comes in from any port, the Switch will record the source address, port no. And the other related information in address table. This information will be used to decide either forwarding or filtering for future packets.

5.3 Forwarding & Filtering

When one packet comes from some port of the Ethernet Switching, it will also check the destination address besides the source address learning. The Ethernet Switching will lookup the address-table for the destination address. If not found, this packet will be forwarded to all the other ports except the port, which this packet comes in. And these ports will transmit this packet to the network it connected. If found, and the destination address is located at different port from this packet comes in, the Ethernet Switching will forward this packet to the port where this destination address is located according to the information from address table. But, if the destination address is located at the same port with this packet comes in, then this packet will be filtered. Thereby increasing the network throughput and availability

5.4 Store-and-Forward

Store-and-Forward is one type of packet-forwarding techniques. A Store-and-Forward Ethernet Switching stores the incoming frame in an internal buffer, do the complete error checking before transmission. Therefore, no error packets occurrence, it is the best choice when a network needs efficiency and stability.

The Ethernet Switch scans the destination address from the packet-header, searches the routing table provided for the incoming port and forwards the packet, only if required. The fast forwarding makes the switch attractive for connecting servers directly to the network, thereby increasing throughput and availability. However, the switch is most commonly used to segment existence hubs, which nearly always improves overall performance. An Ethernet Switching can be easily configured in any Ethernet network environment to significantly boost bandwidth using conventional cabling and adapters.

Due to the learning function of the Ethernet switching, the source address and corresponding port number of each incoming and outgoing packet are stored in a routing table. This information is subsequently used to filter packets whose destination address is on the same segment as the source address. This confines network traffic to its respective domain, reducing the overall load on the network.

The Switch performs "Store and forward" therefore, no error packets occur. More reliably, it reduces the re-transmission rate. No packet loss will occur.

5.5 Auto-Negotiation

The STP ports on the Switch have built-in "Auto-negotiation". This technology automatically sets the best possible bandwidth when a connection is established with another network device (usually at Power On or Reset). This is done by detect the modes and speeds at the second of both device is connected and capable of, Both 10Base-T and 100Base-TX devices can connect with the port in either Half- or Full-Duplex mode.

If attached device is:	100Base-TX port will set to:
<ul style="list-style-type: none">• 10Mbps, no auto-negotiation	10Mbps
<ul style="list-style-type: none">• 10Mbps, with auto-negotiation	10/20Mbps (10Base-T/Full-Duplex)
<ul style="list-style-type: none">• 100Mbps, no auto-negotiation	100Mbps
<ul style="list-style-type: none">• 100Mbps, with auto-negotiation	100/200Mbps (100Base-TX/Full-Duplex)

6. TROUBLESHOOTING

This chapter contains information to help you solve problems. If the Ethernet Switch is not functioning properly, make sure the Ethernet Switch was set up according to instructions in this manual.

The Link LED is not lit

Solution:

Check the cable connection and remove duplex mode of the Ethernet Switch

Some stations cannot talk to other stations located on

The other port

Solution:

Please check the VLAN settings, trunk settings, or port enabled / disabled status.

Performance is bad

Solution:

Check the full duplex status of the Ethernet Switch. If the Ethernet Switch is set to full duplex and the partner is set to half duplex, then the performance will be poor. Please also check the in/out rate of the port.

Why the Switch doesn't connect to the network

Solution:

- Check the LNK/ACT LED on the switch
- Try another port on the Switch
- Make sure the cable is installed properly
- Make sure the cable is the right type
- Turn off the power. After a while, turn on power again

APPENDIX A

A.1 Switch's RJ-45 Pin Assignments

1000Mbps, 1000Base T

Contact	MDI	MDI-X
1	BI_DA+	BI_DB+
2	BI_DA-	BI_DB-
3	BI_DB+	BI_DA+
4	BI_DC+	BI_DD+
5	BI_DC-	BI_DD-
6	BI_DB-	BI_DA-
7	BI_DD+	BI_DC+
8	BI_DD-	BI_DC-

Implicit implementation of the crossover function within a twisted-pair cable, or at a wiring panel, while not expressly forbidden, is beyond the scope of this standard.

A.2 10/100Mbps, 10/100Base-TX

When connecting your 10/100Mbps Ethernet Switch to another switch, a bridge or a hub, a straight or crossover cable is necessary. Each port of the Switch supports auto-MDI/MDI-X detection. That means you can directly connect the Switch to any Ethernet devices without making a crossover cable. The following table and diagram show the standard RJ-45 receptacle/connector and their pin assignments:

RJ-45 Connector pin assignment		
Contact	MDI Media Dependant Interface	MDI-X Media Dependant Interface -Cross
1	Tx + (transmit)	Rx + (receive)
2	Tx - (transmit)	Rx - (receive)
3	Rx + (receive)	Tx + (transmit)
4, 5	Not used	
6	Rx - (receive)	Tx - (transmit)
7, 8	Not used	

The standard cable, RJ-45 pin assignment

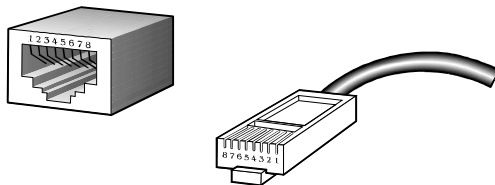

The standard RJ-45 receptacle/connector

There are 8 wires on a standard UTP/STP cable and each wire is color-coded. The following shows the pin allocation and color of straight cable and crossover cable connection:



Figure A-1: Straight-Through and Crossover Cable

Please make sure your connected cables are with same pin assignment and color as above picture before deploying the cables into your network.

Free Manuals Download Website

<http://myh66.com>

<http://usermanuals.us>

<http://www.somanuals.com>

<http://www.4manuals.cc>

<http://www.manual-lib.com>

<http://www.404manual.com>

<http://www.luxmanual.com>

<http://aubethermostatmanual.com>

Golf course search by state

<http://golfingnear.com>

Email search by domain

<http://emailbydomain.com>

Auto manuals search

<http://auto.somanuals.com>

TV manuals search

<http://tv.somanuals.com>