

4 Easy Steps

The fastest way to setup your CS55™ Headset System

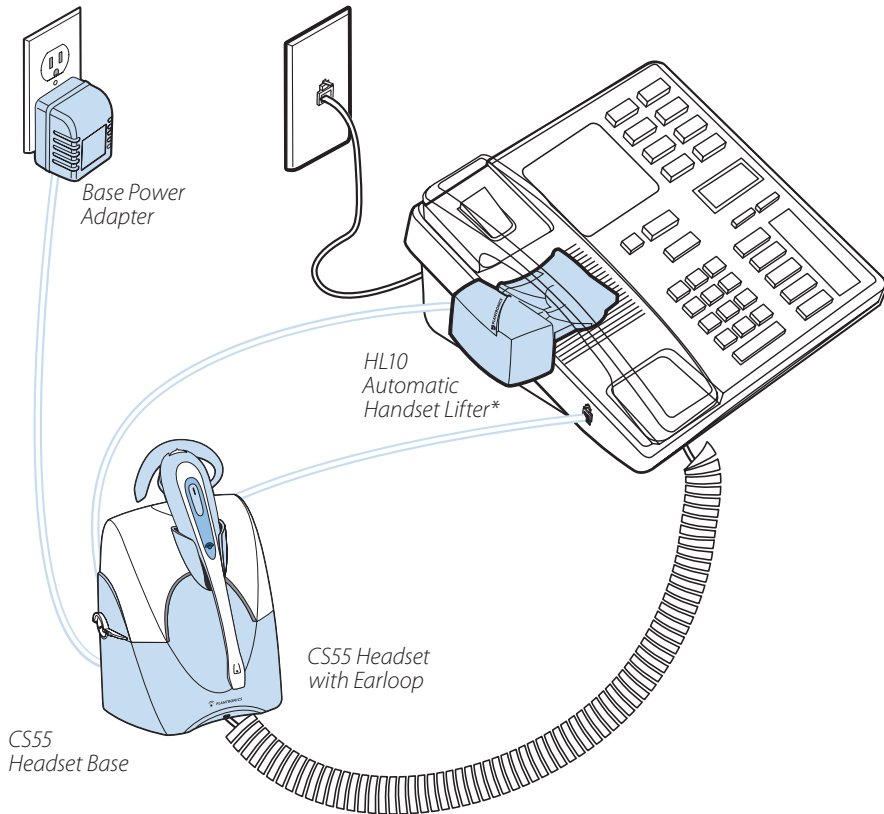

*Not included in all configurations



PLANTRONICS
SOUND INNOVATION™

→ • → **CS55 Series** SETUP GUIDE

CS55 PACKAGE CONTENTS

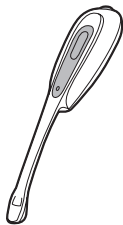

Headset



Setup Guide

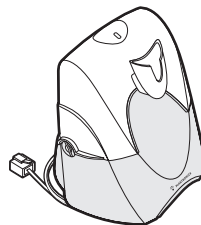

Headset Base with Pre-installed Phone Cable

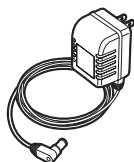

Base Power Adapter



Headband



Ear Loops



Please refer to the separate Safety Instructions for important product safety information prior to installation or use of the product.

CS55 With Automatic Handset Lifter* Adds:

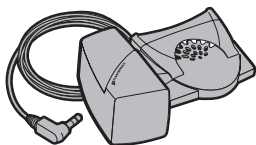

HL10 Automatic Handset Lifter



HL10 User Guide

*Automatic Handset Lifter is bundled with certain CS55 configurations and also available separately.

HL10 Additional Parts Kit (if needed)

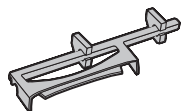

Extender Arm



Ringer Microphone



Adapter for Nortel i2004 Phones

STEP 1

ATTACH HEADBAND OR EARLOOP TO HEADSET & ADJUST FIT

Snap the speaker of the headset into the retaining ring of the headband or one of the three ear loops provided. See below.

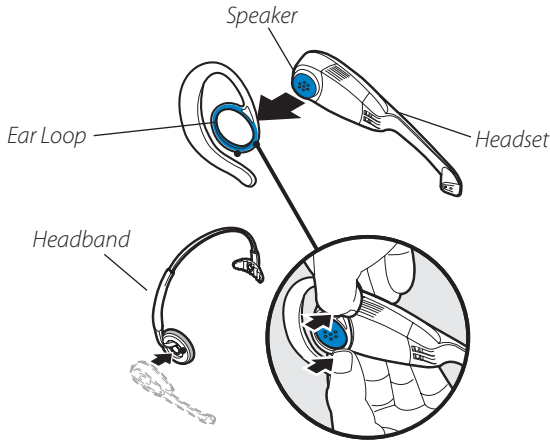

If you will be wearing the headband, adjust the band for the most comfortable fit. See 1 below.

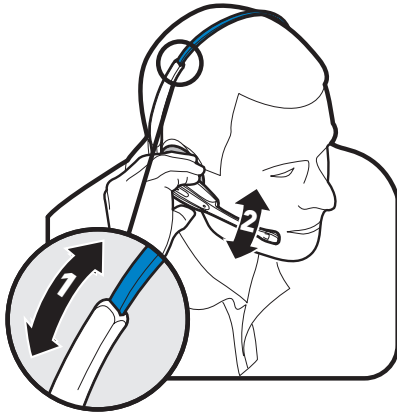

For either wearing option, rotate the headset in the retaining ring until the microphone is pointed toward your mouth. See 2 above.

2 CONNECT BASE TO DESK PHONE

Use **Configuration A** if:

You will use the Automatic Handset Lifter

or...

Your phone has NO built-in headset functionality (no Headset button).

Configuration A

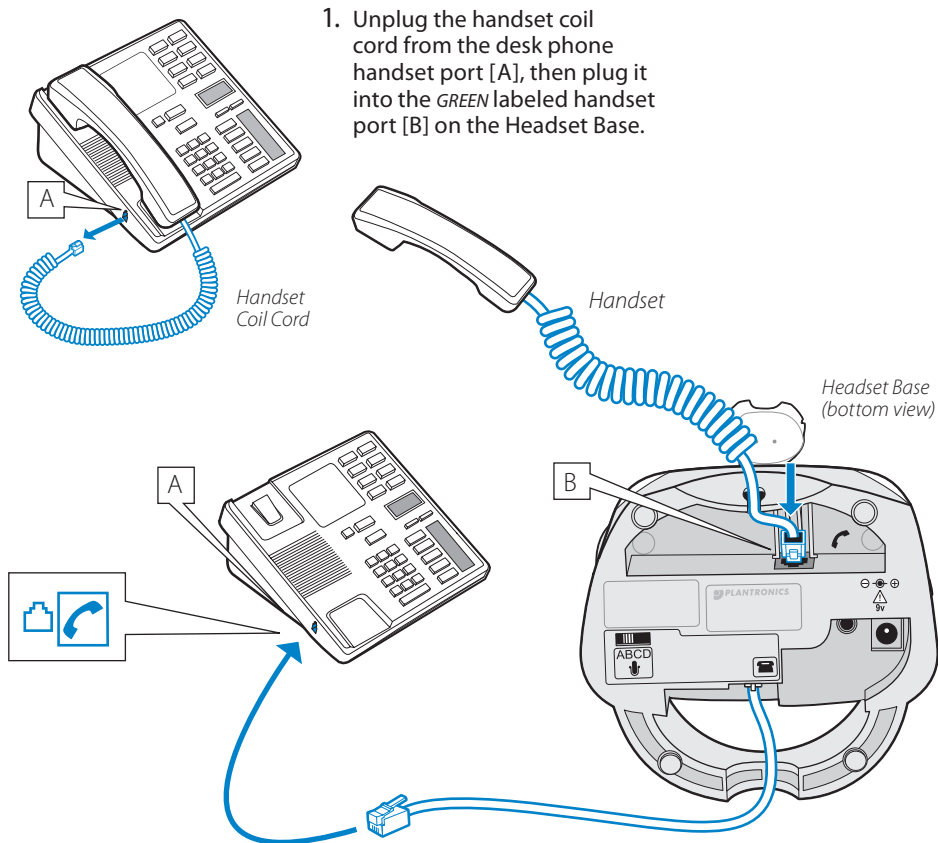

2. Plug the short **BLACK** Phone Cable that is pre-installed on the Headset Base into the now-open handset port [A] on the desk phone.

Use **Configuration B** if:

You will NOT use the Automatic Handset Lifter
and...

Your phone has built-in headset functionality (a Headset button).

Configuration B

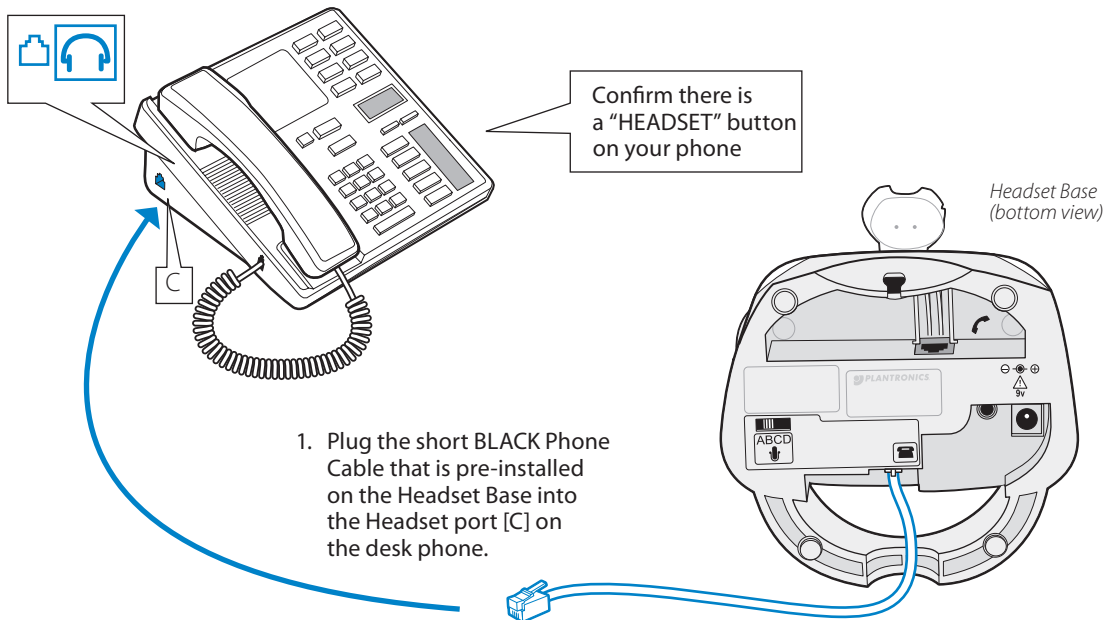

  or   ?

HANDSET port or HEADSET port?

You should only use the headset port if you will *NOT* be using the Automatic Handset Lifter *AND* you have a pre-programmed Headset button on your phone.

In this configuration you *MUST* press both the Headset button on your phone and the Call Control Button on the headset to answer/end calls.

3 CONNECT POWER AND CHARGE HEADSET

A. Connect Headset Base to power outlet

1. Plug the Base Power Adapter into a wall outlet, then plug the power cord into the *YELLOW* labeled connector on the bottom of the Headset Base. The *RED* Power light on the left front of the Headset Base will turn on. (See illustration at bottom of page.)

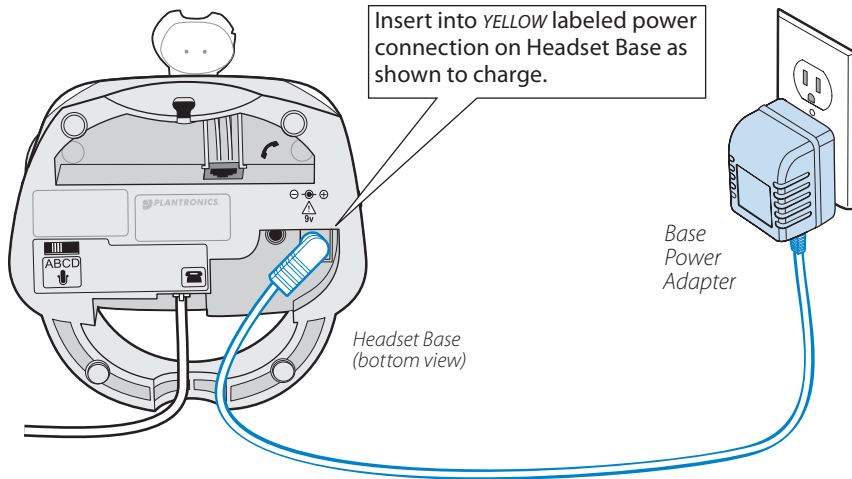

B. Charge the Headset for at least 20 Minutes before using

1. Gently push the headset into the charging cradle as shown below. The *AMBER* Charge Status light on the base will flash to indicate the headset battery is charging. A solid light indicates full charge. A full charge will take approximately 3 hours.

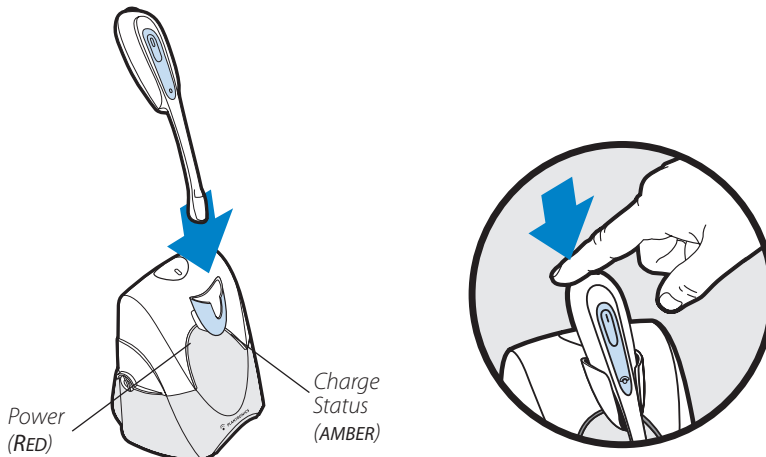

INSTALL AUTOMATIC HANDSET LIFTER

Why use a handset lifter? The lifter greatly simplifies using a headset with your desk phone. It lets you answer and end calls without being near your phone.



The HL10 Automatic Handset lifter is included with certain CS55 configurations and is also available separately.

A. Connect Handset Lifter power cord to Headset Base

1. Verify that the base-to-desk phone cable is connected to the handset port of the desk phone, and not the headset port (Refer to Step 2, Configuration A).
2. **FIRMLY PRESS** the Handset Lifter power cord into the **RED** labeled port to ensure a complete connection.

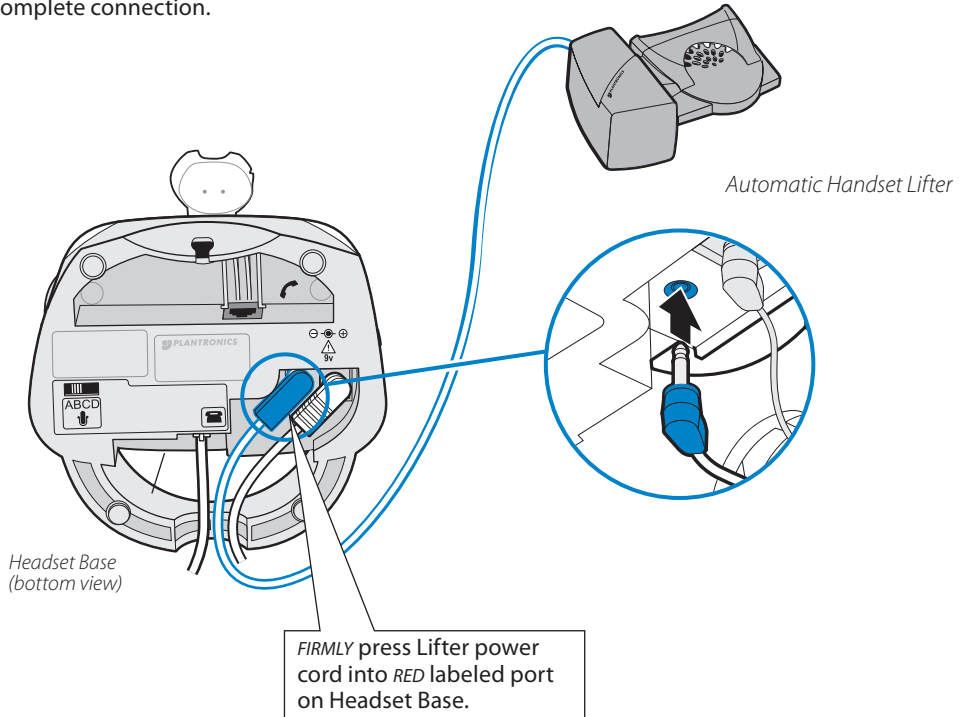

B. Determine Lifter position and height setting

1. Set the Lifter Height Switch to the lowest setting.

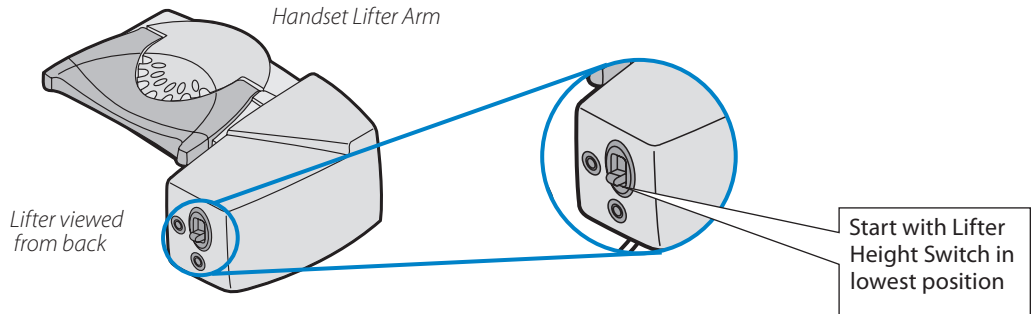

2. While wearing your headset, slide the Handset Lifter Arm under the handset until the lifter base touches the side of the phone.
3. Slide the Lifter up to where it nearly touches the handset earpiece.

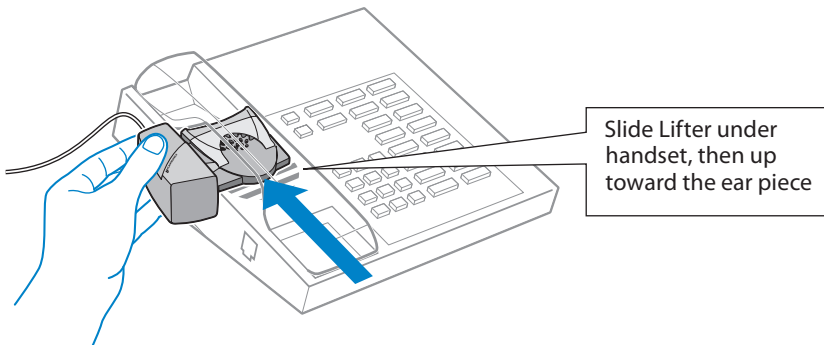

Use the Extender Arm to Stabilize Handset (if needed)

If your handset falls off the phone base or does not return to its cradle when lowered, you will need to attach the Extender Arm to the Lifter as described in the HL10 Additional Parts Kit.

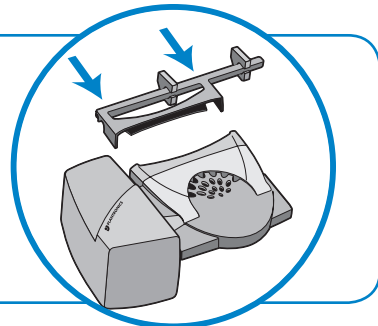

4. Press the Call Control Button on the headset. This will activate the Handset Lifter and lift the handset from the phone.

If you hear a dial tone, the lifter height is set correctly and needs no adjustment. Please continue with the next section "Mount the Lifter in permanent position" on the following page.

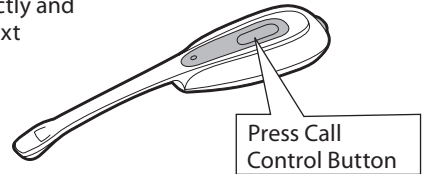

5. If you do not hear a dial tone, the Lifter may not be raising the handset high enough OR the Configuration Dial may need adjusting. Continue to step 6.
6. Check the Lifter height adjustment by moving the Lifter Height Switch to a higher position. Repeat steps 2 through 4 as necessary.

If you hear a dial tone, the lifter height is now set correctly. Please continue with the next section "Mount the Lifter in Permanent Position".

7. If you still cannot hear a dial tone, you will need to change the setting on the Configuration Dial. Using a coin or paperclip, turn the Configuration Dial to a different setting until you hear a dial tone. To view an interactive quick start guide online, visit www.plantronics.com/CS55.

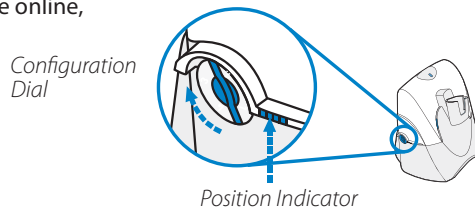

Multiple settings might work with your phone; however, only one is the optimal position.

If you still cannot hear a dial tone, please call Technical Support at 800-544-4660 Extension 5538.

C. Mount the Lifter in permanent position

1. Remove the protective strips from the three mounting tapes on the underside of the Lifter.
2. *GENTLY* place the Lifter on the desk phone in the optimum position as determined above. Test the Lifter to verify positioning by pressing the Call Control Button on your headset to activate the Lifter and listen for a dial tone.
3. Press *FIRMLY* to adhere the Lifter to the desk phone.

USING YOUR CS55 HEADSET SYSTEM



For your safety, do not use headset at high volumes for extended periods of time. Doing so can cause hearing loss. Always listen at moderate levels. For more information on headsets and hearing visit: www.plantronics.com/healthandsafety

If your desk phone has a volume control, set it to mid-range.

Powering up the Headset

If the headset battery is charged and the base is connected to power, the headset is automatically on. The CS55 does not have an *ON/OFF* button

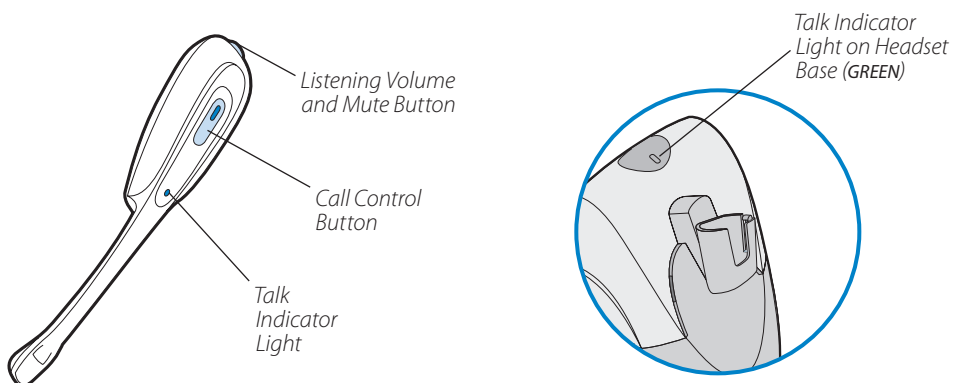

To Place, Answer, or End Calls

Desk phone Configuration	ALL phones with Handset Lifter	Phones WITHOUT Headset button and NO handset lifter	Phones WITH Headset button and NO handset lifter
To place a call	1. Press Call Control Button 2. Dial number	1. Press Call Control Button 2. Remove handset from cradle 3. Dial number	1. Press Call Control Button 2. Press Headset button on phone 3. Dial number
To answer a call	1. Press Call Control Button	1. Press Call Control Button 2. Remove handset from cradle	1. Press Call Control Button 2. Press Headset button on phone
To end a call	1. Press Call Control Button	1. Press Call Control Button 2. Return handset to cradle	1. Press Call Control Button 2. Press Headset button on phone

To Mute a Call

Push in the mute control to activate mute, push in again to de-active.
(You will hear a slight beep in the speaker when mute is activated.)

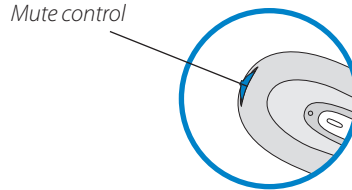

Set Listening Volume

While on a call, adjust the listening volume by using the Listening Volume Switch on the back of the Base.

Listening Volume Switch

Position 1 = Loudest
Position 4 = Softest

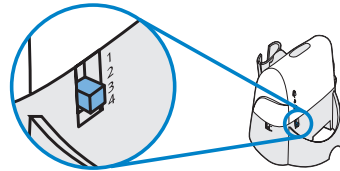

To Fine Tune Listening Volume

Rock the headset volume control back and forth to adjust listening volume in minor incremental adjustments.

NOTE: You must be in talk mode (i.e. on a call) to adjust

Volume controls

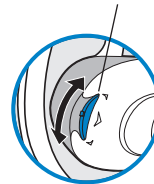

Set Speaking Volume

While on a call, set the Speaking Volume Switch to the best setting for the listener (a paper clip or pen tip can help). Too high a setting can produce an uncomfortable echo for you and distorted sound for your listeners. You will be able to make minor adjustments to speaking volume while on a call using the Speaking Volume Control on the back of the base.

Speaking Volume Switch

Position A = Softest
Position D = Loudest

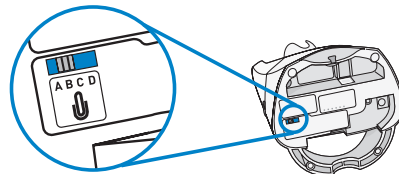

Congratulations!

You have successfully set up your CS55 Series Headset System.

To begin using your Headset System or help with service, support, or warranty information, please continue with the next several pages.

To Fine Tune Speaking Volume

While on a call, you can adjust your speaking volume by using the Speaking Volume Minor Adjustment Control on the back of the base. Listening volume can be adjusted on the headset.

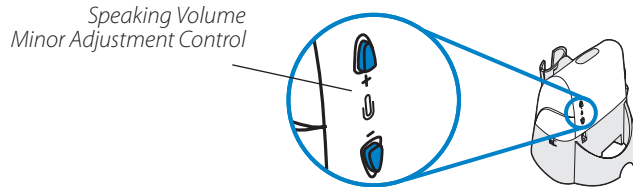

To set the IntelliStand™ Feature

The CS55 IntelliStand feature allows you to choose how to activate your headset when answering or making a call. Consider how you'll use your headset to determine the best setting for you.

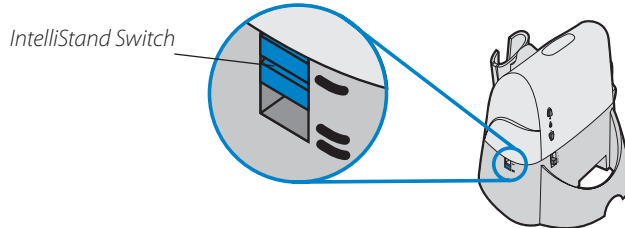

In the *UP* position, answer, make or end a call by pressing the Call Control Button on your headset. Choose the *UP* position if you plan to wear your headset most of the time.

In the *DOWN* position, calls are initiated, or answered by taking the headset out of the stand. A short delay gives you time to put the headset on. Choose the down position if you think you'll wear your headset *ONLY* while on calls. In the *DOWN* position you can still answer, end or make a call by pressing the Call Control Button.

In either the up or down position, placing the headset in charging cradle will end the call.



If the sound quality is poor or background noise is evident after these adjustments readjust the configuration dial for better quality.

CS55 LIGHTS AND TONES

Indicator Lights

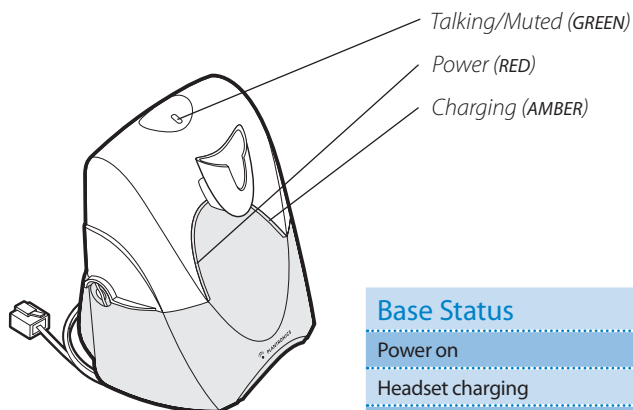

Base Status	Base Light
Power on	Solid red
Headset charging	Flashing amber
Headset fully charged	Solid amber
Headset in talk mode	Solid green
Headset in mute mode	Flashing green
Headset Status	Headset Light
Headset in talk mode	Flashing amber

Tones

Out of Range Warning:

If you are on a call and walk out of range of the base, your headset will issue audible tones at its operating limit.

If you are on a call, you will hear two tones when reaching edge of range, and again when back in range. If you stray out of range, active calls will be suspended. Calls will be re-established on walking back into range. If you remain out of range for more than 10 minutes the system will drop the call.

Low Battery Warning:

When battery is low, a single tone repeats every ten seconds. You should recharge the headset immediately.

Mute Warning:

When Mute is first activated, three rapid high tones will sound. These tones will repeat every 15 seconds while Mute is active.

When Mute is deactivated you will hear three rapid low tones.

Subscription

The headset and base unit are supplied subscribed to each other. However, if you wish to use a replacement headset with the base unit, then the units must be re-subscribed as follows:

Return the headset to the charging cradle.

1. Press and hold both speaking volume fine tune buttons on the base unit for a minimum of 5 seconds. The power indicator will then flash red.
2. Press and hold the headset mute button for a minimum of 5 seconds. The talk indicator light on the headset will then illuminate green.

Successful re-subscription is indicated when the base power indicator is fully illuminated and the headset talk indicator light is off.

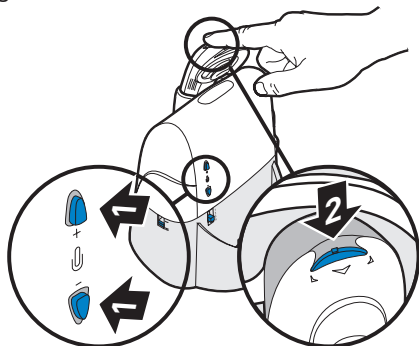

If re-subscription fails within 2 minutes, the headset will return to the un-subscribed state. Try the re-subscription process again or call Technical Support.

System Reset

To recover from some fault conditions you may need to perform a system reset.

1. Press both the call control button and the listening volume/mute button for 5 seconds. When the talk indicator light blinks, release both buttons.
2. Press the call control button again. The talk indicator light will again blink briefly to indicate the headset is back to normal operation.
3. Disconnect the AC charger from the AC charging jack for 5 seconds.
4. Reconnect.

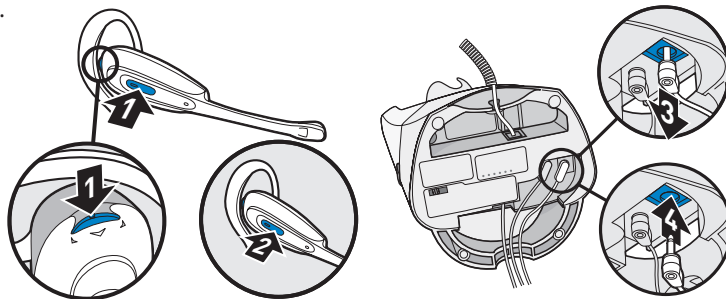

The system reset operation is complete.

TROUBLESHOOTING AND COMMON QUESTIONS

I can't hear a dial tone at the headset

- Make sure your headset is charged.
- Press the Call Control Button on your headset.
- Make sure the lifter is lifting the handset high enough to operate the hookswitch; set to a higher setting if necessary.
- Adjust the Configuration Dial on the left side of the base. Align the "1" on the dial with the ridges to the right side of the dial. If there is no dial tone for setting "1" try the other dial settings. Adjust the Listen Volume Button on the headset. If the volume is still too low, select another setting on the Listening Volume Switch on the headset base.

I hear static

- Make sure there is at least 12" between your CS55 base and your computer, and 6" between your base and your telephone. If adjusting the distance doesn't help, your base settings may need adjusting.
- Your system may need to be reset. See the System Reset procedure on page 14 (also in the User Guide available online at www.plantronics.com/CS55).

The sound is distorted or I hear an echo in the headset.

- Reduce speaking volume by changing the Speaking Volume Major Adjustment Switch.
- Point microphone towards your chin.
- Listening volume may be too high on phone. If your phone has a handset volume control, lower this until the distortion disappears.
- If the distortion is still present, lower the volume using the Listen Volume Button on the headset.

If the distortion persists, select another Listening Volume Switch setting on the headset base.

- Make sure there is 12" distance between your CS55 base and your computer, and 6" between your base and your telephone.
- System needs to be reset. Perform system reset as described on page 14.

People I talk to can hear a buzz in the background.

- Move the base further away from your phone.
- Power adapter is plugged into a power strip. Plug the power adapter into the wall directly.

Talk time performance is significantly degraded even after a full recharge.

- Battery is wearing out. Call Plantronics at (800) 544-4660 Ext. 5538 for factory service information.

The Handset lifter is installed but does not lift the handset.

- Be sure the handset lifter power cord is firmly pushed into the handset lifter jack on the base.

My handset lifter operates every time I remove or replace my headset in the base.

- IntelliStand is enabled. To disable this feature, move the IntelliStand switch to the UP position. See page 12.

The call is dropped. (Talk indicator in the headset and base will not be illuminated.)

- Headset lost subscription. Try to reset the system. See below if this does not work. Try the re-subscription procedure on page 14 (also in the User Guide available online at www.plantronics.com/CS55).

Additional Information and Support

Additional Information

Additional Information including an Interactive Quick Start Guide, Product Information and Accessories including the HL10 Automatic Handset Lifter and Online Indicator Light can be found at www.plantronics.com/CS55.

Telephone Support

Telephone Tech Support at
800-544-4660 Ext. 5538
(Sunday 3:00 PM to Friday 5:00 PM, PST).

Online Technical Support

www.plantronics.com/support

Knowledge Base FAQs
Live Chat with a Support Technician
Email Support
Product Compatibility Guide
Product Manuals
(including all available language versions)
Service
Product Registration



This Plantronics headset delivers superior durability and reliability backed by a one-year warranty.

Questions? 800-544-4660 www.plantronics.com

Plantronics Limited Warranty

- This warranty covers defects in materials and workmanship of products manufactured, sold or certified by Plantronics which were purchased and used in the United States.
- This warranty lasts for one year from the date of purchase of the products.
- This warranty extends to you only if you are the end user with the original purchase receipt.
- We will, at our option, repair or replace the products that do not conform to the warranty. We may use functionally equivalent reconditioned/refurbished/remanufactured/pre-owned or new products or parts.
- To obtain service in the U.S., contact Plantronics at (800) 544-4660 Ext. 5538.
- THIS IS PLANTRONICS COMPLETE WARRANTY FOR THE PRODUCT.
- This warranty gives you specific legal rights, and you may also have other rights that vary from state to state. Please contact your dealer or our service center for the full details of our limited warranty, including items not covered by this limited warranty.

Maintenance

- Always unplug the Headset Base from the telephone and the Base Power Adapter from the power source before cleaning.
- Clean the equipment with a damp (not wet) cloth.
- Do not use solvents or other cleaning agents.

Battery replacement

The custom battery supplied in your headset should last 2–3 years. When talk time decreases significantly, the battery may need replacing. Please call Plantronics at (800) 544-4660 Ext. 5538 to order a new battery.

Still having problems?

Given the hundreds of different types of phones, it's possible a trick or two may be needed to make the CS55 System work with your desk phone. For further help:

- For the product knowledge base and instant live chat with Technical Support:
www.plantronics/support
- For the Plantronics Technical Support Center (open from Sunday 3:00 PM to Friday 5:00 PM PST, except major U.S. holidays): **800-544-4660 Ext. 5538**

© 2007 Plantronics, Inc. All rights reserved. Plantronics, the logo design, CS55, IntelliStand, and Sound Innovation are trademarks or registered trademarks of Plantronics, Inc. All other trademarks are the property of their respective owners.

Patents U.S. 5,210,791; 6,735,453; 6,903,693; D469,756; D492,667; D519,975; Australia 147229 and 303306; EM 293964 and 69109; France 651,857-651,865; Germany 40108524.4; GB Regd.Des.No. 2104923; Taiwan D109301; Patents Pending

Printed in USA.

76529-02 (04.07)



PLANTRONICS
SOUND INNOVATION™

Plantronics, Inc.
345 Encinal Street
Santa Cruz, CA 95060 USA
www.plantronics.com

Free Manuals Download Website

<http://myh66.com>

<http://usermanuals.us>

<http://www.somanuals.com>

<http://www.4manuals.cc>

<http://www.manual-lib.com>

<http://www.404manual.com>

<http://www.luxmanual.com>

<http://aubethermostatmanual.com>

Golf course search by state

<http://golfingnear.com>

Email search by domain

<http://emailbydomain.com>

Auto manuals search

<http://auto.somanuals.com>

TV manuals search

<http://tv.somanuals.com>