

# PLUS

**Copyboard with Memory Function**

# **M-11S/M-11W/M-115**

---

## **User's Manual**

**Thank you for your purchase of the PLUS Copyboard.  
Please read this User's Manual carefully before use to take full advantage of the functions of this product. After you have finished reading the manual, please keep it for future reference.**

---

The descriptions in this manual are for the M-11S, M-11W and M-115.

There are three types of copyboards: the 2-page standard size type (model M-11S), the 2-page wide size type (M-11W) and the 4-page + screen type (M-115).

In addition, depending on the product you have purchased, the printer and stand may be sold separately.

The descriptions and diagrams in this manual refer to the model M-11S.

\* When functions or operations are specific to a certain model of copyboard, the model name is specified.

## Trademarks

- Microsoft and Windows are registered trademarks or trademarks in the United States and other countries of the Microsoft Corporation.
- Adobe and Adobe Acrobat Reader are trademarks of Adobe Systems Incorporated.

The trademarks of the various companies and the product trademarks, even when not written down, will be given due respect. Product names and company names appearing in this manual are registered trademarks or trademarks of the respective companies.

- (1) The contents of this manual may not be reprinted in part or whole without permission.
- (2) The contents of this manual are subject to change without notice.
- (3) Great care has been taken in the creation of this manual; however, should any questionable points, errors, or omissions be apparent, please contact us.
- (4) Notwithstanding Section (3), this company will not be responsible for any claims of loss or profit or other matters deemed to be the result of using this unit.
- (5) The use of a printer as the peripheral device of the PLUS Copyboard is taken to be a prerequisite; therefore, operation will not be guaranteed when the Copyboard is used with a direct connection to a personal computer.
- (6) Manuals with incorrect collating or missing pages will be replaced.

# Table of Contents

---

<b>Important Safety Information</b> .....	<b>E-4</b>
<b>Package Contents</b> .....	<b>E-7</b>
<b>Main Functions</b> .....	<b>E-8</b>
<b>Names of the Parts</b> .....	<b>E-9</b>
Front .....	E-9
Rear.....	E-10
Changing the Height of the Unit .....	E-11
Control Panel (models M-11S and M-11W) .....	E-12
Control Panel (model M-115) .....	E-13
<b>Operation Steps</b> .....	<b>E-14</b>
<b>Connections</b> .....	<b>E-15</b>
<b>Setting the Time</b> .....	<b>E-17</b>
<b>Printing</b> .....	<b>E-19</b>
Preparing the Printer .....	E-19
Basic Printing Operation .....	E-20
Selecting the printing density .....	E-22
Making additional copies .....	E-22
Cancellation of the print operation in progress .....	E-22
Specifying the Page (model M-115) .....	E-23
Switching to the screen (model M-115).....	E-23
Printing in the same ratio as the sheet surface (Model M-11W) .....	E-23
Moving the sheet surface manually .....	E-23
<b>Using USB Memory</b> .....	<b>E-24</b>
USB Memory Storage Procedure.....	E-24
Saving Image Files to a Personal Computer, and Deleting Image Files .....	E-26
<b>Supplied Software Setup Guide</b> .....	<b>E-28</b>
Software Contents and Overview.....	E-28
Operating Environment .....	E-28
Installing the USB driver.....	E-29
Acquiring images of the copyboard directly by the computer.....	E-31
Using the Setup Utility.....	E-32
Disconnecting USB Connections with the Main Unit.....	E-33
Uninstalling the software .....	E-33
<b>Meaning of Error Messages</b> .....	<b>E-34</b>
<b>Troubleshooting</b> .....	<b>E-35</b>
<b>Specifications</b> .....	<b>E-36</b>

---

## Meaning of the Terms Used in this Manual

- USB memory: refers to USB flash memory.
- USB memory storage: means the saving of blackboard data using MEMORY (i.e., the USB port) of the operation panel. (The Copyboard has 3 USB ports.)
- Internal memory: indicates a temporary saving location of the image that has been read.
- “copy”: Both “print” and “USB memory saving” mean to “copy.”
- Page (model M-115): The number assigned to the sheet surface is called the “page”.
- Screen (model M-115): The “S” page for projecting images of optical devices is called the “screen”.
- “Sheet surface”: refer to the drawing portion.
- “Scroll” or “move”: indicates feeding of the sheet.

# Important Safety Information

## WARNING

The unit's rear panel should never be opened by anyone other than a qualified serviceperson. Contact your store of purchase to request internal inspection, adjustment, repair, and cleaning.



## CAUTION

Continued use of the unit under abnormal conditions (when the unit is emitting smoke, unusual odors or sounds) could lead to fire or electric shocks.

Turn off the unit's power immediately, then unplug the AC power adapter from the power outlet.

Check that no more smoke, etc., is being emitted, then contact a sales outlet for repairs.

Repairing the unit yourself is dangerous. Never attempt to do so.

## WARNING

This is a FCC class A product. In a home environment this product may cause radio interference in which case the user may be required to take adequate measures.

## WARNING

This product is not for use in Computer Rooms. The description "Computer Rooms" refers to areas where an abundance of computer control equipment (such as high output servers) is being used.

It does NOT refer to environments such as offices or classrooms where there are simply PC's being used.



This symbol warns the user that uninsulated voltage within the unit may have sufficient magnitude to cause electric shock. Therefore, it is dangerous to make any kind of contact with any part inside of this unit.



This symbol alerts the user that important literature concerning the operation and maintenance of this unit has been included. Therefore, it should be read carefully in order to avoid any problems.



## SAFETY PRECAUTIONS

Heeding the safety precautions below will lengthen the product's service life and prevent fires, electric shocks and injury. Read these safety precautions carefully and be sure to heed them.

### Handling the AC power adapter

- Do not connect any AC adapter other than the dedicated one to the unit. Doing so could result in fire or other accidents.
- Do not use with voltages other than the voltage indicated. Doing so could result in fire or electric shock.
- Do not let the AC power adapter get wet. Doing so could result in fire or electric shock.
- Do not subject the AC power adapter to shocks. Doing so could result in fire or electric shock.

### Handling the AC power adapter's cord and plug

- Damaging the power cord could lead to fire or electric shock.
    - When installing, do not squeeze the power cord between the product and a wall, rack, etc.
    - Do not modify or damage the power cord.
    - Do not place heavy objects on the power cord or pull strongly on it.
    - Do not place the power cord near heating appliances or otherwise heat it.
    - When unplugging the power cord, always do so by pulling on the plug, not the cord.
- If the power cord should be damaged, ask your store of purchase to replace it.
- If there is dust or metal objects on or near the power plug's blades, unplug the power cord then wipe the blade area clean using a dry cloth. Continued use without cleaning the plug could lead to fire or electric shock.
  - Do not plug in or unplug the power cord with wet hands. Doing so could lead to electric shock.
  - When moving the unit, turn off the power and be sure to unplug the power cord from the AC outlet first. Moving the unit with the power cord plugged in could damage the cord, leading to fire or electric shock.
  - Connect the power plug securely to the AC outlet, pressing the blades in to the hilt. Incomplete plugging could cause heating or attract dust, leading to fire. In addition, touching the plug's blades could cause electric shock.

# Important Safety Information

---

## Reflected Light from the Sheet Surface

The sheet surface of the main unit has a white glaze and when a projector or other optical equipment is projected, the reflected light could result in eye fatigue or other symptoms, so please be careful.

For model M-115, an image can be projected on the copyboard when you switch to the screen panel.

Also note that the light emitted from laser pointers can be linked to unexpected accidents, so please refrain from using them.

## Do not use the included CD-ROM in a player designed for audio CDs.

- Never use the included CD-ROM in a player designed for audio CDs. Doing so could produce loud noises that could impair your hearing. These noises can also damage your speakers.

## Installation

- When mounting on a wall, be sure to check first that the wall surface is strong enough to support the total weight of the main unit, mount fittings and printer for a long period of time (including during earthquakes). If the wall is not strong enough, reinforce it before mounting the unit.
- Getting water on or inside the unit etc., could lead to fire or electric shock. Be particularly careful when using the unit near a window when it is raining or snowing and when using it near the shore of the ocean and lakes.
- Do not set the unit in hot places exposed to direct sunlight or in places exposed to an air conditioner or heating duct. Do not set the unit in places exposed to soot or humidity (near humidifiers, etc.).
- When the power plug will be unplugged from the power outlet, please place the Copyboard near the power outlet so that it may be reached easily.

## Preventing Tipping (for stand type units)

To prevent tipping, heed the instructions below. Tipping could lead to personal injury or damage the unit.

- Use the unit on a flat floor.
- Be sure to attach the supplied stabilizers to the stand, and lock the stoppers of the casters. Failing to do so could result in the unit tipping and could lead to personal injury.
- Do not lean against the unit or apply excess force to the top of the unit.

## Cautions on Usage

- Take care that the unit does not get wet and that water does not get inside. Do not place objects containing chemicals, water or other liquids (vases, potted plants, glasses, cosmetics, etc.) on top of the unit. The liquid could spill and get inside the unit, leading to fire or electric shock.
- When lifting the unit to adjust the height, etc., the unit should be lifted by at least two persons to prevent it from tipping and causing personal injury.
- Do not move the sheet with paper or other objects attached to it. Doing so could cause damage.
- Do not wipe the unit or sheet with thinner, benzene, alcohol or other such products. Doing so could cause discoloration or damage the sheet.
- Only use markers designed exclusively for this product. Using other markers could damage the sheet. Also note that it may not be possible to erase the ink of other markers.
- When moving the (stand type) unit, remove the stabilizers and release the caster locks. Hold the sides of the main unit and move it gently. Avoid shocks.
- When not using for long periods of time, for safety be sure to unplug the AC power adapter from the power outlet.
- Make entries within the effective reading size. (See page E-9) Portions that are drawn outside of this range might not be printed or copied when saving to USB memory or personal computer.

## Important Safety Information

---

### Cleaning

- If the sheet is dirty, wipe it clean using a damp, thoroughly wrung out cloth. For tough dirt, apply some diluted neutral detergent to a cloth, wipe off the dirt, then wipe again to remove any detergent.  
Wait until the sheet is completely dry before using it.
- Do not wipe the copyboard or sheet with thinner, benzene, alcohol, etc. Doing so could cause discoloration or damage the sheet.
- Wipe off any marks from markers on the pen tray or the frame cover using a damp, thoroughly wrung out cloth.  
For cleaning of the printer, please refer to the printer's operating instructions.

### Handling the CD-ROM

- Do not touch the surface which has no printing (the surface on which the data is recorded). If this surface is dirty the data will not be read properly.  
Also, do not stick paper, stickers, etc., on the CD-ROM.
- Do not leave for long periods of time in places exposed to direct sunlight or near heating appliances, and do not drop or bend the CD-ROM. The disc may get warped, making it impossible to read the data.

### USB Memory

- The USB memory formats supported by the copyboard are FAT 12/16, and FAT 32. There are also types of USB memory that cannot be used by this unit. Check the PLUS Vision web site for types of USB memory that have been verified to work with the copyboard.
- As a provision against the unlikely event of a problem with or disappearance of the data saved in the USB memory, we recommend that the data be regularly saved to other media.
- PLUS Vision will not be responsible for the loss of content stored in the internal memory of this unit (i.e., images that have been read), or in USB memory.

### USB Cables

Use USB shielded cable that has USB-IF logo compliance. Do not use this unit with a connection to a USB hub. The unit may not operate properly.

### Do not draw on the screen (model M-115)

The screen is designed exclusively for use with optical devices. If you draw on the screen, the ink cannot be erased with the included eraser. If you accidentally draw on the screen, wipe off the ink with a diluted solution of neutral detergent, then carefully wipe off any remaining detergent.

- Note that copying illegal material (tantamount to possession of illegal material) is subject to prosecution.
- This product includes parts considered as "strategic material" as per the Foreign Exchange and Foreign Trade Control Act of Japan. Authorization as per said Act is required to export this product from Japan.

# Package Contents

The package contents are as described below. Please check before use.

## Copyboard, main unit [1]

See "Assembly and Setup Manual" for information about the assembly parts of the copyboard.

## Printer\* [1]

Please see the instruction manual of the printer for information about the printer accessories.

## Stand\* [1]

\*The printer and stand may be sold separately.

\* Depending on the product you have purchased, the printer and stand may be sold separately.

## Copyboard Accessories

### • Special markers

(One each of black, red, blue, and green)

Use these markers to draw on the sheet surface.

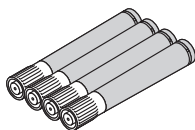

### • Special eraser [1]

Use this to erase the drawing.

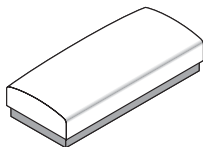

### • AC power adapter (with power cord) [1]

This is the power adapter for supplying power to the copyboard (See Page E-16). (HEC-AP065-24V)

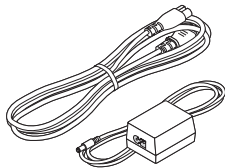

### • USB cable (type B ↔ type A) [1]

[PLUS code 715255400]

This cable is used to connect the dedicated printer with the printer output connector of the copyboard. (See Page E-15).

(The cable can be used for a personal computer connection if it is not used with the printer. See Page E-29.)

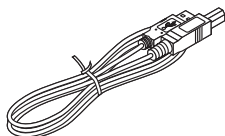

### • Cushions [2 pcs.]

These cushions are used to absorb the shake of printer tray in case wall mounting. (See the Assembly and Setup Manual.)

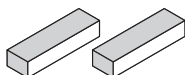

### • Wall mount brackets [1 set]

These fittings are used to mount the copyboard on a wall (See the Assembly and Setup Manual.).

(The set includes four copyboard brackets and 16 M4 mounting screws.)

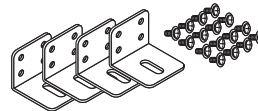

### • Printer tray [1 set]

The printer is placed on this tray.

(The set includes one printer tray, brackets for left and right sides, 12 M3 assembly screws, 4 M4 screws, 3 printer guides, 5 cable clips and 2 20 cm cable ties and 2 10 cm cable ties)

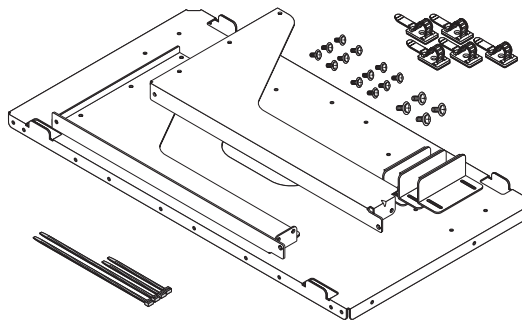

## Documents

### • User's manual [1]

Includes information about safety precautions and the use of the copyboard.

### • CD-ROM [1]

The CD-ROM contains the instruction manual (PDF edition) and the utility software for use with the copyboard.

### • Quick Guide [1 set]

The Quick Guide can be hung from a hook in a convenient location close to the copyboard.

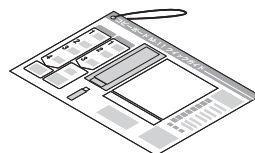

### • Assembly and Setup Manual

Information covers the setup of the copyboard and the connections with the printer.

# Main Functions

---



## **Text or images drawn on the copyboard's sheet surface can be printed in color or black and white on regular paper.**

A press of the "Print" button on the operation panel quickly prints what has been hand written on the sheet surface to regular LETTER or A4 size paper.

By mitigating the need to take notes, the participants of the meeting can concentrate on the agenda.

The paper printout can be written on and a stamp can also be affixed which is convenient if it is to be kept as a record of the meeting, or circulated. The printer can continuously print a maximum of 20 sheets.



## **Text or images drawn on the copyboard's sheet surface can be stored in a USB memory device as image files.**

When a USB memory device is inserted into the bottom of the control panel and the "Save" button is pressed, the material drawn by hand on the sheet surface is stored as an image file in the USB memory device.



## **Text or images drawn on the copyboard's sheet surface can be loaded directly onto a computer as image files.**

The copyboard can be connected to a computer via USB cable and one page worth of material can be loaded onto the computer as image data.



## **4 copyboard pages + 1 screen (model M-115)**

In addition to the 4-page copyboard function, this model includes a screen designed for projecting images with a regular or overhead projector. This screen can be selected at the touch of a button. A single machine serves as both the copyboard and projector screen, saving space and preparation time.

\* You cannot draw on the screen with markers. Also note that you cannot print images projected on the screen surface or save them on a USB memory device or computer.



## **Maintenance-free, Low Power Consumption**

RGB, 3-primary-color LEDs are used as the reading light source which means that there is no need to replace a fluorescent tube as with previous copyboard models. In addition, unlike fluorescent tubes, LEDs need only be lit when reading the sheet surface which is reflected in low power consumption.



# Names of the Parts

## Front

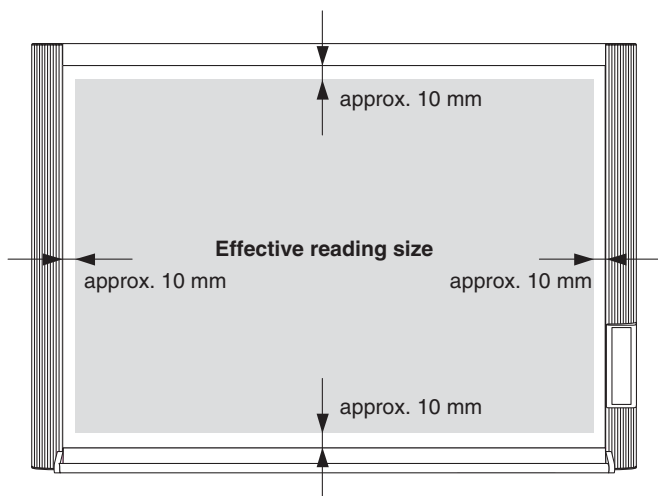
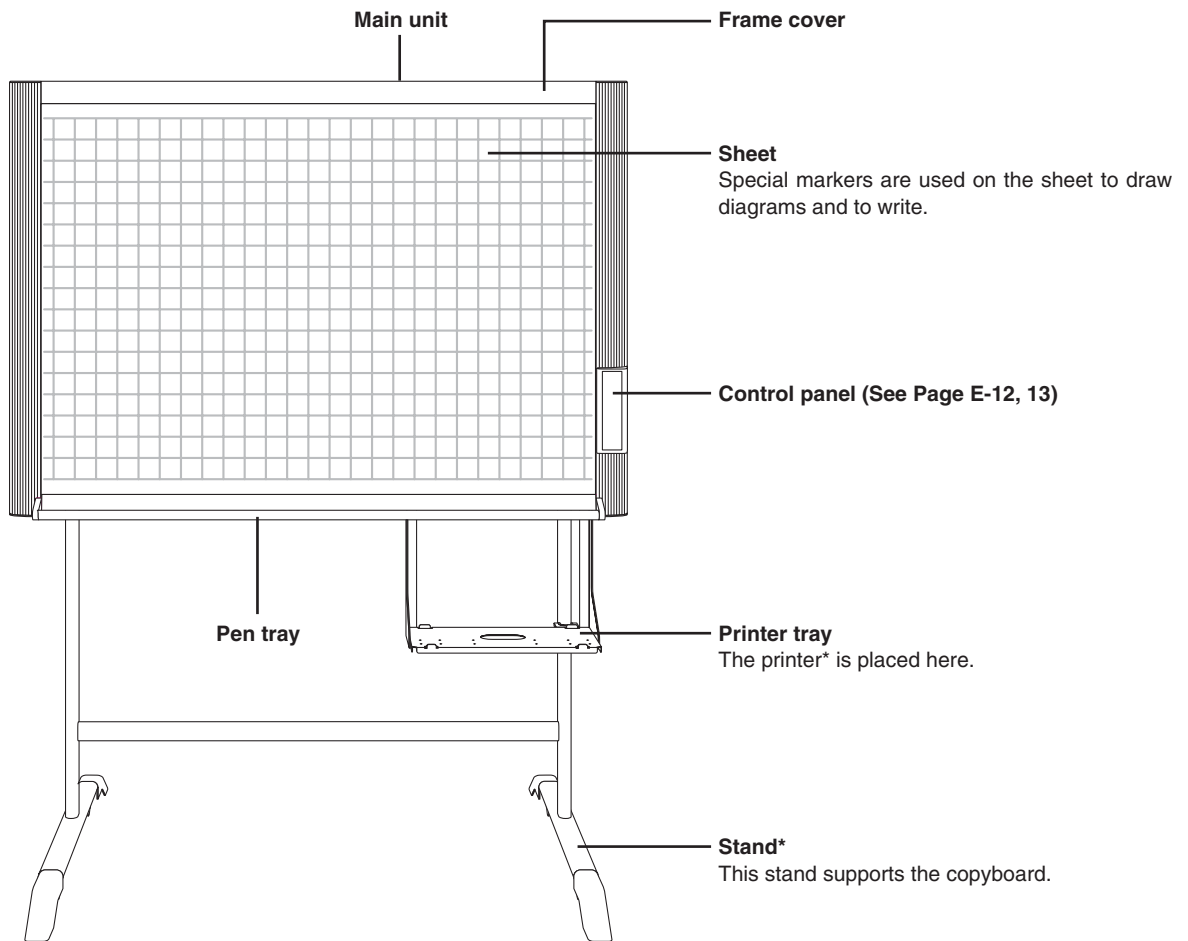

### Effective Reading Size

The area that can be copied is the gray area of the diagram.

#### Note

- It might not be possible to print or copy when storing to USB memory or personal computer any portions that are drawn outside of this range.

\* Depending on the product you have purchased, the printer and stand may be sold separately.

## Names of the Parts

### Rear

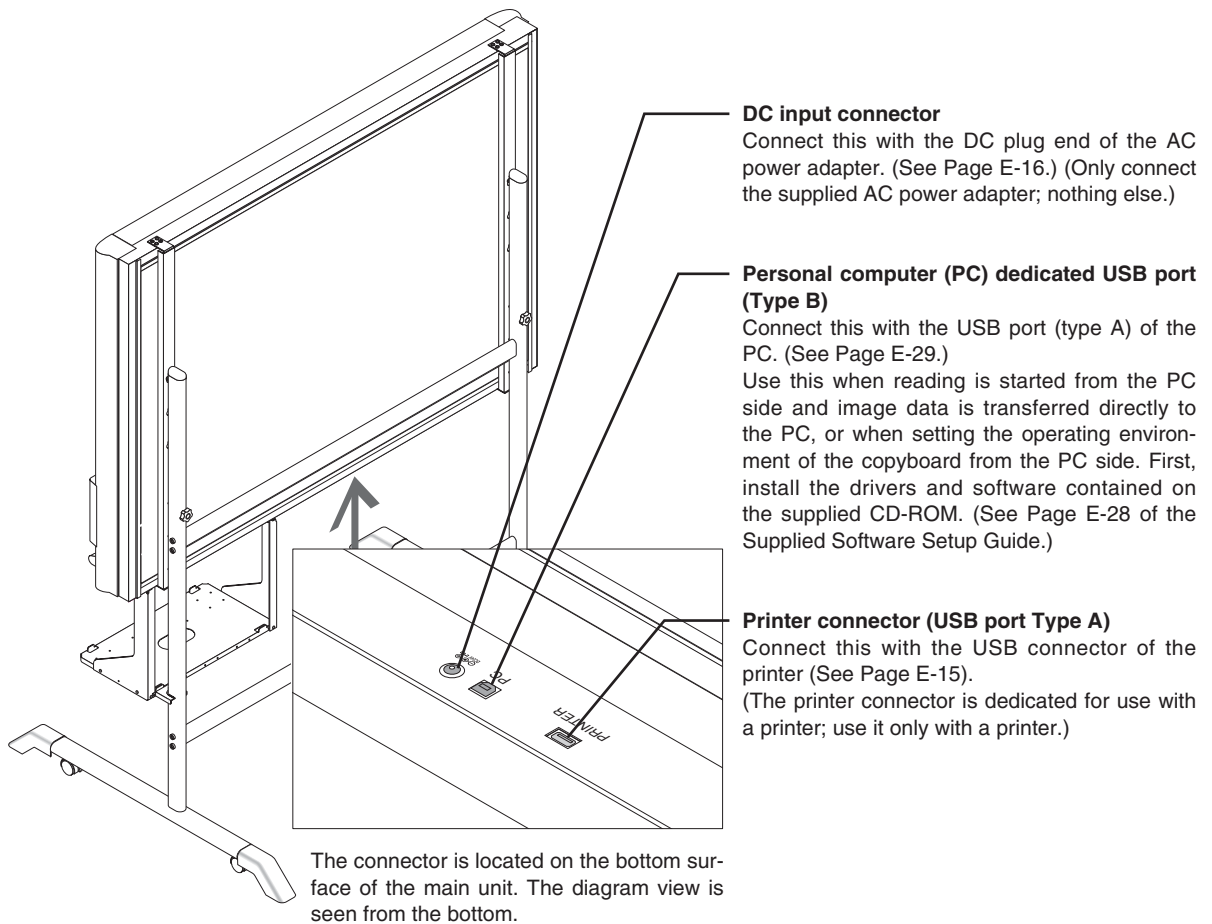

### Locking and unlocking the casters of the stand\*

Lock the casters with the stopper after setup. To move the unit, remove the stabilizers and release the caster stopper. Press the bottom of the stopper to lock it. Press the top to release it.

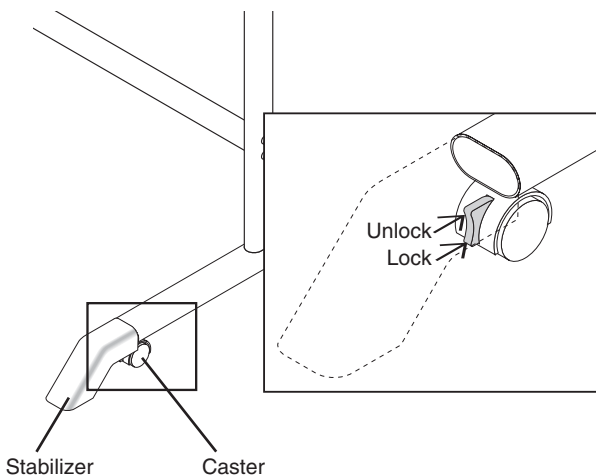

### Changing the Height of the Unit

This is the height adjustment when setting up the copyboard on the optional stand. The stand height can be adjusted to 3 levels in 100 mm units.



#### CAUTION

Please have 2 or more people hold the unit. If the unit is dropped or falls over, this could cause unexpected injury.

Please lock the casters by pushing the lower portion of the lock button.

**(1) Disconnect the power cable and all other connection lines.**

**(2) Take out the printer and remove the printer tray.**

Please loosen the printer guide fastening screws before removing the printer.

Remove the two M4 screws from bottom side of the printer stand and the other two from the rear surface.

**(3) Remove the two lock knobs (located at the left and right sides).**

**(4) Change the hole position of the rear frames.**

The copyboard will disengage from the hooks when it is lifted up about 1 cm.

Fully hook the (left and right) installation holes of the rear frames onto the hooks of the stand.

If a stay (for preventing shaking) is mounted on the printer stand, insert the stay in its original position.

**(5) Attach the lock knobs to the 2 locations (left and right) and tighten to the rear frames.**

**(6) Return to original by following the steps in reverse.**

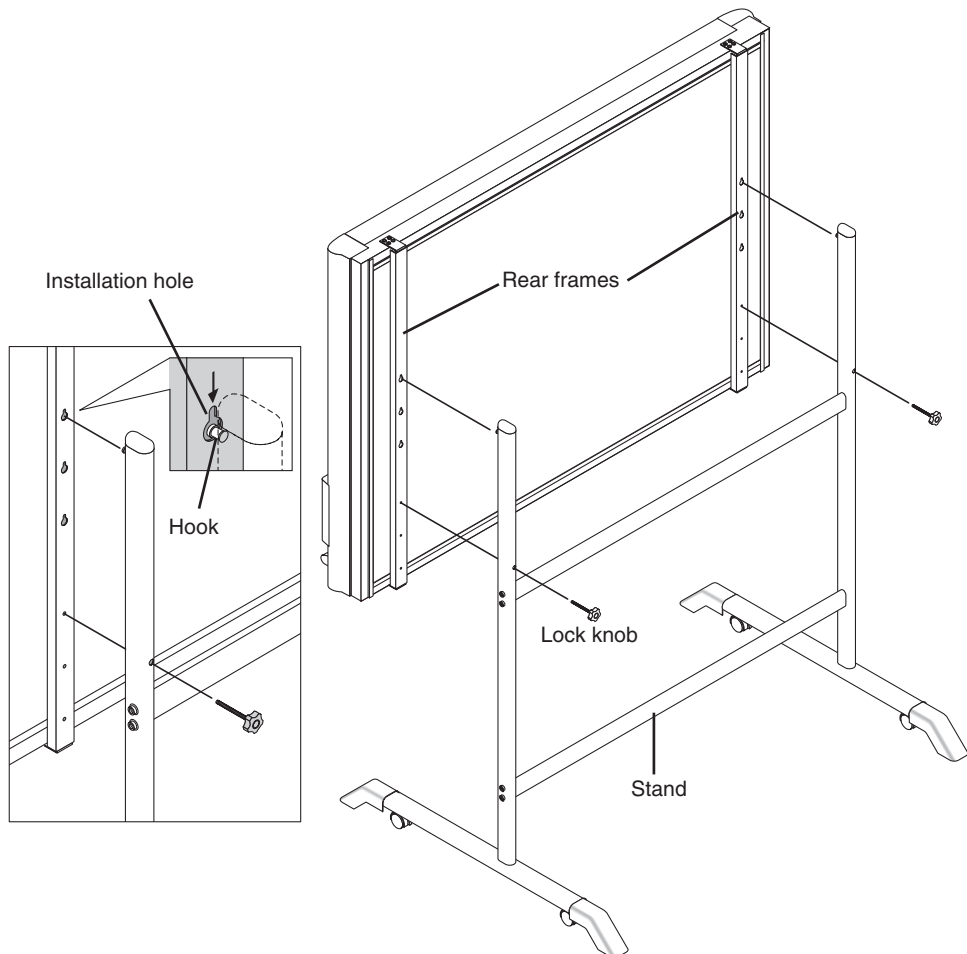

### Control Panel (models M-11S and M-11W)

When pressing a button, please press the center area (i.e., the round and protruding portion). The button may not work if it is pressed on a corner.

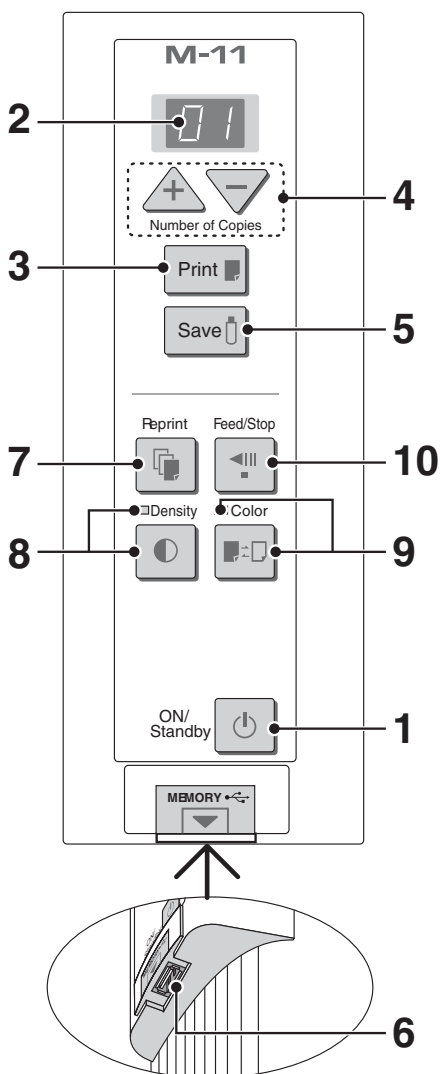

#### 1 ON/Standby button

Turns the copyboard's power on and off (standby mode).

Pressing the ON/Standby  button in combination with another button permits setting of the current time and the print compression. See pages E-17 and E-23 for details.

#### 2 Display window

This 7-segment LED displays the number of copies to be printed, the USB memory storage operating condition, and error information. Please see Page E-34 for details about error information.

#### 3 Print button

Moves a one-screen portion of sheet and reads it, then prints the number of copies displayed in the display window.

#### 4 + / - buttons (Number of copies)

Pressing the + button or the - button sets the number of copies to be printed (to a maximum of 20 sheets). The number of copies appears in the display window.

#### 5 Save button (USB memory storage)

Moves a one-screen portion of sheet and reads it, then stores the data on a USB memory.

#### 6 Memory port (USB port Type A)

Saves in commercially-available USB memory images that have been read by the copyboard.

#### 7 Reprint button

Prints the previously printed sheet surface one more time. (The sheet does not move.)

The number of copies can be changed, but the density and the color/monochrome selection cannot be changed.

#### 8 Density button

Selects the copying density, either "standard" or "dark". This function will be effective at time of printing, USB memory storage, and personal computer storage.

##### Density mode lamp

The density mode indicator lights green when "dark" is selected.

#### 9 Color button

Selects whether to print (or store in memory) in "color" or "black & white".

##### Color mode lamp

The indicator lights green when "color" is selected.

\*When a black & white printer is connected, the printout will be in black & white even when "Color" is selected.

#### 10 Feed/Stop button

Scrolls the sheet one screen portion left, then stops automatically. A press of this button while scrolling will stop the scrolling.

## Control Panel (model M-115)

When pressing a button, please press the center area (i.e., the round and protruding portion). The button may not work if it is pressed on a corner.

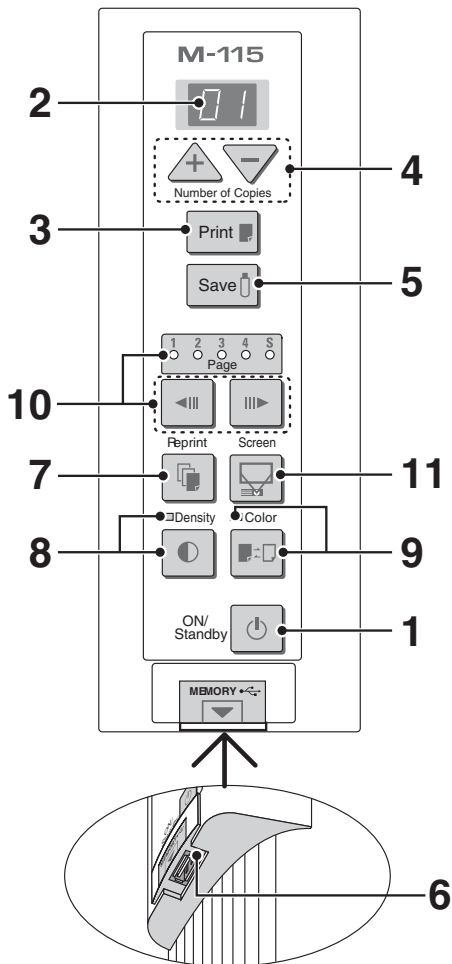

### 1 ON/Standby button

Turns the copyboard's power on and off (standby mode).

Use the button to cancel printing, storing or page change.

The ON/Standby  button is used together with other buttons to set the current time. For details, see page E-17.

### 2 Display window

This 7-segment LED displays the number of copies to be printed, the USB memory storage operating condition, and error information. Please see Page E-34 for details about error information.

### 3 Print button

Moves a one-screen portion of sheet and reads it, then prints the number of copies displayed in the display window.

### 4 + / - buttons (Number of copies)

Pressing the + button or the - button sets the number of copies to be printed (to a maximum of 20 sheets). The number of copies appears in the display window.

### 5 Save button (USB memory storage)

Moves a one-screen portion of sheet and reads it, then stores the data on a USB memory.

### 6 Memory port (USB port Type A)

Saves in commercially-available USB memory images that have been read by the copyboard.

### 7 Reprint button

Prints the previously printed sheet surface one more time. (The sheet does not move.)

The number of copies can be changed, but the density and the color/monochrome selection cannot be changed.

### 8 Density button

Selects the copying density, either "standard" or "dark". This function will be effective at time of printing, USB memory storage, and personal computer storage.

#### Density mode lamp

The density mode indicator lights green when "dark" is selected.

### 9 Color button

Selects whether to print (or store in memory) in "color" or "black & white".

#### Color mode lamp

The indicator lights green when "color" is selected.

\*When a black & white printer is connected, the printout will be in black & white even when "Color" is selected.

### 10 Page change / buttons

Use these to switch pages.

- Each press of the  page change button moves the page indicator one step in the sequence of 1 → 2 → 3 → 4 making it flash, and scrolls the copyboard to the specified page.

- Each press of the  page change button moves the page indicator one step in the sequence of S → 4 → 3 → 2 → 1 making it flash, and scrolls the copyboard to the specified page.

Note

- Scrolling to the screen (S page) is not possible with the  page change button.

#### Page indicators



The indicator for the currently displayed page lights (green).

When scrolling, the indicator for the specified page flashes while the page is scrolling, then stops flashing, remaining lit, once scrolling stops.

### 11 Screen button

When pressed, the sheet scrolls to the screen (the S page).

# Operation Steps

The copyboard uses a CCD image sensor to read the diagrams and text that have been written down with special (4-color) markers, and accumulates the image data in internal memory. Pressing the Print  button prints out the sheet surface image data from the printer, and pressing the Save  button stores the image data to USB memory.

## Preparation

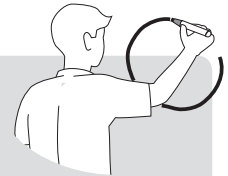

- **Set up the newly purchased copyboard and connect a printer.**  
See a separate manual titled "Assembly and Setup Manual."
- **Connect a printer. See page E-15.**
- **Connect the supplied AC power adapter. See Page E-16.**
- **Set the time of the newly purchased copyboard. See Page E-17.**



## Draw on the Sheet Surface



Please draw with the special markers that have been supplied. To erase, use the supplied special eraser. Please be sure to draw with the special markers. Failure to do so may result in a drawing that cannot be erased or soiling of the sheet. To move the sheet manually (models M-11S and M-11W only), see "Moving the Sheet Surface Manually" on page E-23.

## Printing

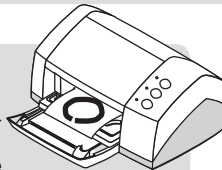
- (1) Set A4 or letter size paper.  
Do not set anything other than A4 or letter size paper.
- (2) Press the ON/Standby  button of the copyboard and switch on the power.
- (3) Switch on the printer power.  
For instructions on operating the printer, see the printer's operating instructions.
- (4) Press the Print  button. The copyboard will move a one-screen portion of sheet, read the image, and start the copy operation\*.  
See "Printing" on Page E-19.



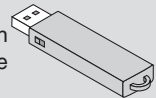

## Saving to USB Memory

- (1) Press the ON/Standby  button of the copyboard to switch on the power.
- (2) Insert USB memory into the Memory  port (USB port) of the copyboard.
- (3) Press the Save  button.  
See "Using USB Memory" on Page E-24.





## When Not Using the Copyboard

- (1) By all means, cleanly erase the drawing from the sheet surface with the special eraser. (Leaving the drawing for a long period will make it harder to erase.)
- (2) Press the ON/Standby  button of the copyboard and switch off the power (standby mode).  
The power cannot be switched off while the USB memory remains installed. (This is a prevention function against forgetting to unplug the USB memory.)
- (3) Switch off the printer power.

\* A press of the Save  button while printing is in progress will store the image in USB memory after printing is completed. Likewise, a press of the Print  button while the memory storage operation is in progress will start the printing operation after USB memory storage is completed. This convenience allows both printing and USB memory storage to be performed with a single image reading.

## Note

- Press the ON/Standby  button more than 5 seconds after connecting the AC power adapter to the copyboard unit or after turning off the power.
- The color of the images when printed in color or when saved in USB memory will differ somewhat from the marker colors.
- Blurred characters, thin lines, overlapping of markers and other factors can cause colors to differ in places and can also result in portions that cannot be scanned successfully. When "Density" is set to "Deep", the overall print may be dark and the ruled line may appear on the copy.  
In the case of the combination of Deep and Color Mode, the black ink may be mixed into other color.
- The built-in memory accumulates the read data that was previously printed or stored in USB memory. This data is erased when the power is switched off with the ON/Standby  button.

# Connections

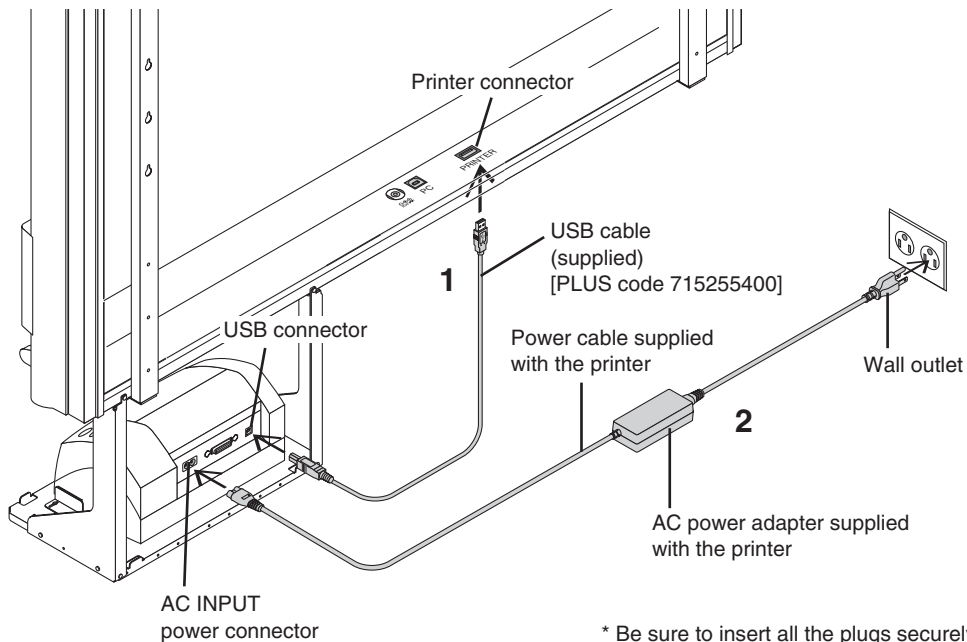

- 1 Connect the copyboard's printer connector with the printer's USB connector using the supplied USB cable.**

#### Notice

*For page printers*

*When installing the printer for the first time, remove the protective sheet for use during transportation from the image drum cartridge before connecting the power cord. (For directions on removing the sheet, see the printer's operating instructions.)*

- 2 Use the power cable supplied with the printer to connect the AC INPUT power connector of the printer with the wall outlet.**

#### Note

*The printer's AC power adapter (either the included adapter or one that has been confirmed to operate properly) may differ from the one described on the connections diagrams (it could be of the built-in type or imposed type), but the connection procedures are the same.*

- 3 This completes the connection of the printer.**

Connect the copyboard's power supply. See "Connecting the Copyboard's AC Power Adapter" on the following page.

\* The printer shown in the diagram is for explanatory purposes only. Please refer to the printer user manual for proper connections.

## Connection

---

### Connecting the Copyboard's AC Power Adapter

To use the copyboard, connect the supplied AC power adapter.

---

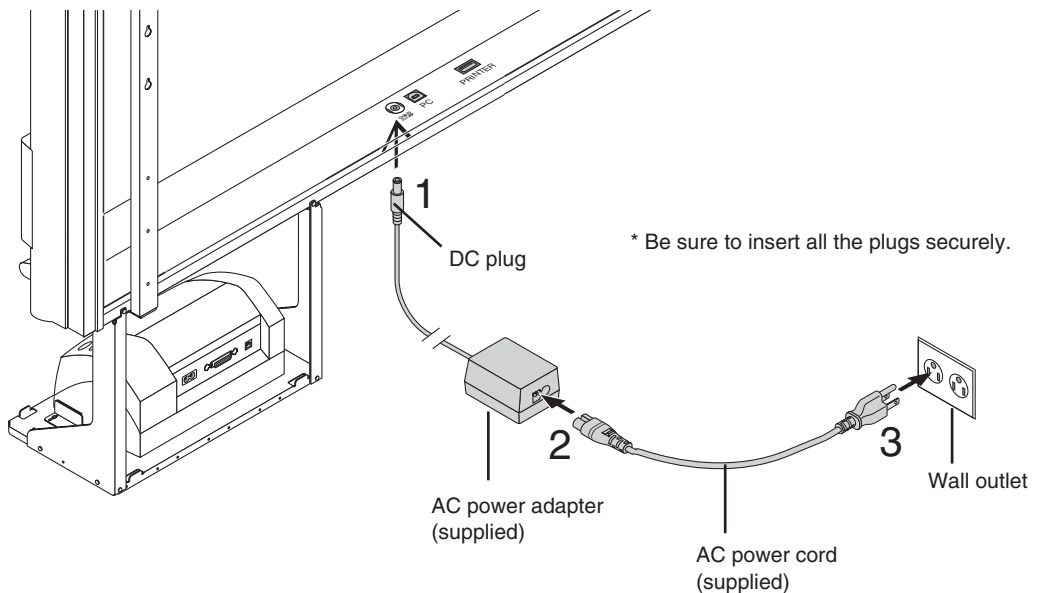

**1 Connect the DC plug of the AC power adapter to the DC power connector of the copyboard.**

**2 Connect the AC power cord to the AC power adapter.**

Once the printer and the copyboard's power supply are connected, fasten them in place using the included cable clips and cable ties.

**3 Plug the AC power cord into a AC power outlet in a wall.**

The main power turns on. In this manual, this is referred to as the "standby mode".

The descriptions in this manual assume that the AC power adapter is connected (that the unit is in the standby mode).

#### When not using the copyboard for long periods of time

Disconnect the AC power adapter's power plug from the AC power outlet in the wall.

---

#### Notice

- When the AC power adapter's power plug is unplugged from the power outlet, place the copyboard near the power outlet so that it can be reached easily.
  - The supplied AC power adapter and AC power cord are intended for exclusive use with this product. Never use them with another product.
-



# Setting the Time

The clock of the copyboard should be set correctly because the date and time (timestamp) is printed on the printer paper, and it is also recorded in the file information when saving.

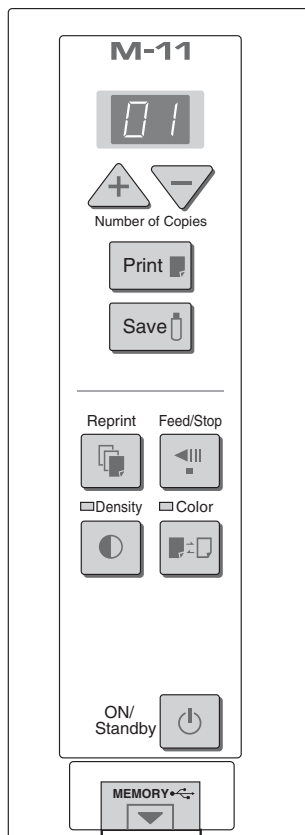

## Overview of the Operation

### 1 Switch to “Time setting”

Press the ON/Standby button while holding down the Density button.

### 2 Display the day and hour setting mode

Setting mode information indicated in the display window

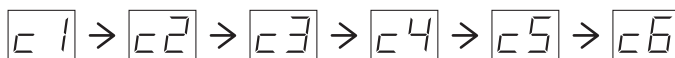

### 3 Set the date and time of the setting mode

One press of the + or the – button will enable the settings to be made. Press the + or – button and make the adjustment.

### 4 Press the Print button to finalize

There is a change to the next setting mode. Repeat steps 3 and 4 to set the current time.

### 5 Completion

If the Print button is pressed after setting the minutes setting mode (“c6” displayed), the time setting mode is quit.

- Pressing the ON/Standby button during operations 2 to 4 will cancel the incomplete settings and return to the time prior to starting the settings.

## Preparation:

Connect the AC power adapter to the copyboard. See Page E-16.

**Example: Set the time to 2:16 pm, November 8, 2006 (2006.11.08 14:16).**

1

**Press the ON/Standby button to switch on the power.**

The LED of the display window will light and the power will be switched on.

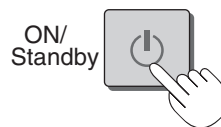

2

**Press the ON/Standby button while holding down the Density button to switch to “Time setting”**

The LED of the display window will light and display “c 1”.



## Setting the Time

3

Press the + button or the – button, select 20 (the first 2 digits of the year), and press the Print button to finalize.

There will be a change to the “last 2 digits of the year” setting mode (c2 display).

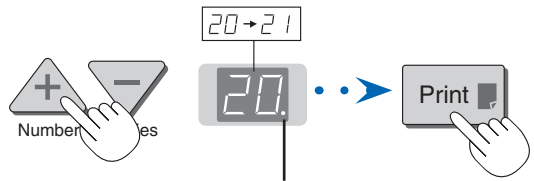

The dot will flash while making settings.

### Note

- The factory default setting is 20. Pressing the Print button in this condition will result in a change to the “last 2 digits of the year” setting mode.

4

Press the + button or the – button, select 06 (the last 2 digits of the year), and press the Print button to finalize.

There will be a change to the “month” setting mode (c3 display).

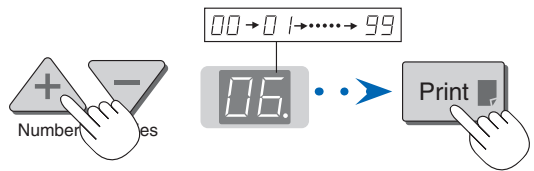

5

Press the + button or the – button, select 11 (the month), and press the Print button to finalize.

There will be a change to the “day” setting mode (c4 display).

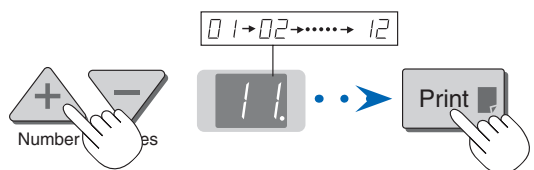

6

Press the + button or the – button, select 08 (the day), and press the Print button to finalize.

There will be a change to the “hour” setting mode (c5 display).

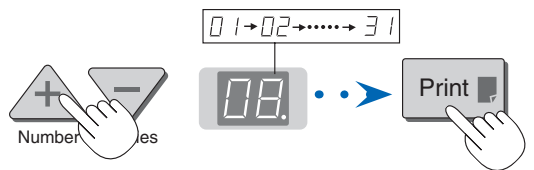

7

Press the + button or the – button, select 14 (the hour of the 24-hour display), and press the Print button to finalize.

There will be a change to the “minute” setting mode (c6 display).

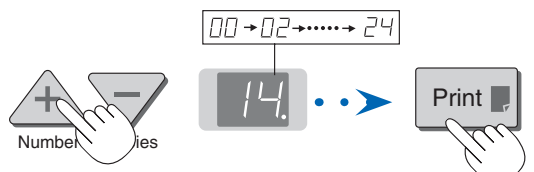

8

Press the + button or the – button, select 16 (the minutes), and press the Print button to finalize.

The display will change to being lit steadily, and there will be a return to the display indicating the number of sheets to copy.

**This completes the time setting.**

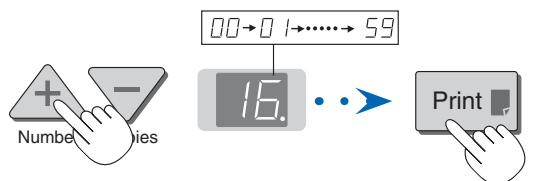

### Note

- The factory default print timestamp is set to “enable (print).” If you do not wish to print the timestamp, use the setup utility in the supplied CD-ROM and set to “disable (do not print).” See the “setup guide of the supplied software” on Page E-28.

# Printing

Use a printer to print out the image that has been drawn on the sheet surface. Operations and names of parts differ from printer to printer. For details of operations, see your printer's operating instructions.

## Preparing the Printer

Please check that the copyboard and the printer have been connected. See Page E-15.

1

### Set the paper.

Please use A4 or letter size printer paper.

See your printer instruction manual for details.

- 1) Arrange the paper edges so that they are even.
- 2) Insert paper at the specified position of the paper tray.
- 3) Press the paper guide gently until it touches the paper.

#### Note

See your printer's operating instructions for a description of the paper that can be used.

2

### Switch on the power.

Press the power switch. The power indicator lights.

#### This completes the preparation of the printer.

Press the Print  button on the copyboard's control panel. One page worth of data is read and the printing operation starts.

#### Notice

- Depending on the printer, indicators, etc., may flash after the power is turned until the printer is prepared to print. In this case, see the printer's operating instructions and check that the printer is ready before starting the printing operation on the copyboard.

3

### When finished printing...

Switch off the printer power and remove the paper.

Close the paper tray.

#### Notice

Caution: Do not turn off the power or disconnect the USB cable during printing.

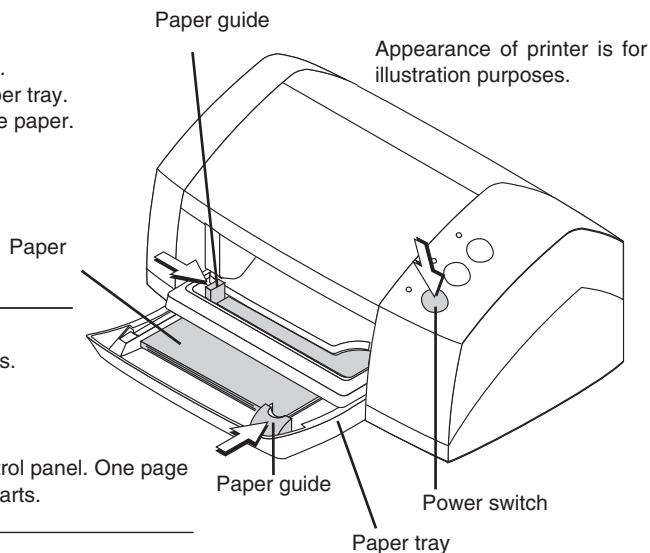

This function prints the sheet screen of the copyboard on the printer connected to the copyboard.

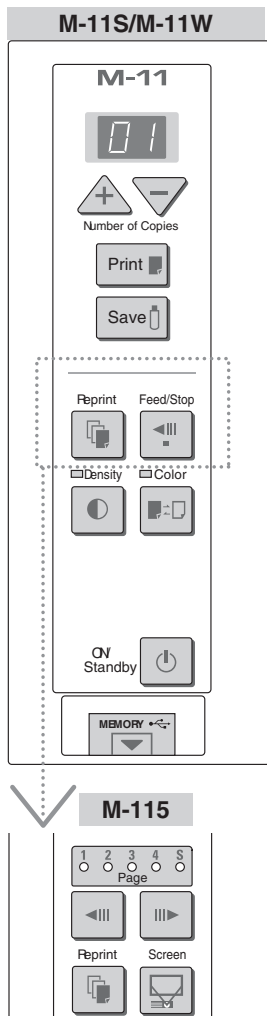

## Basic Printing Operation

### Preparation:

Connect the AC power adapter to the copyboard. See Page E-16.

**1** Press the ON/Standby button and switch on the power.

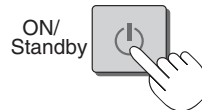

Prepare the printer.

#### Note

- Press the ON/Standby button more than 5 seconds after connecting the AC power adapter to the copyboard unit or after turning off the power.
- Press the ON/Standby button to switch on the power. The LED of the display window will light.
- Turn on the copyboard's power before turning on the printer's power.

**2** Press the Feed/Stop button (for model M-115, the Page change / buttons) and display the sheet surface you want to print.

Feed/Stop



**For models M-11S and M-11W**

A press of the Feed/Stop button scrolls the sheet surface one screen portion left and automatically stops it.

To stop the operation part way through, press the Feed/Stop button again.

**For model M-115**

When the desired page is specified using the Page change / buttons (the corresponding page indicator flashes), the sheet scrolls to the specified page and stops automatically (the page indicator stops flashing, remaining lit).

#### Note

- The one-screen that is visible is printable position.
- To fine-adjust the sheet surface position (M-11S and M-11W only), with the sheet stopped, move the sheet slowly by hand. The sheet can be moved either to the left or to the right.
- It is not possible to print the image projected on the S page (screen) (model M-115 only).
- It might not be possible to print from the area that surrounds the sheet surface. Please see "Effective reading size" on Page E-9.

#### Notice

- If the display content of the page indicator does not agree with that of the actual page, move the copyboard to either Page 1 or the S page.
- For model M-115, do not move the sheet surface by hand. Doing so could damage the copyboard.

Continued on next page

## 3

Press the **Color**  button and select **Color** or **Black & White**.

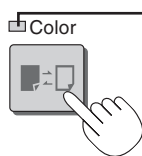

Color mode lamp  
Lit      Printing will be in color.  
Unlit    Printing will be in black & white.

## 4

Press the **+** button or the **-** button and select the number of copies.

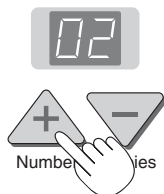

- When the power is switched on, one copy is selected.
- A maximum of 20 copies can be set and the number of copies is displayed in the display window.
- Each press of the + button increases the number of copies (by one) and each press of the - button decreases the number of copies. Press and hold the button to switch continuously.



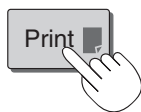

## 5

Press the **Print**  button to print.



- The reading operation is performed for a one-sheet portion (while the sheet is scrolled) and the printing operation is performed.

### Note

- If the Feed/Stop  button (for model M-115, the ON/Standby button) is pressed while the sheet surface is being read, printing is interrupted and only part of the image will be printed. To move the sheet surface, wait until scrolling stops, then press the Feed/Stop  button (for model M-115, the Page change  /  buttons).
- When the fourth page has been printed, after the reading of the page is completed (i.e., printing is completed), there will be a return to Page 4.
- When a USB memory has been inserted, a press of the Save  button during printing will start the USB memory storage operation after printing is completed. (See Page E-24.)
- The one-screen portion is reduced to A4 paper size and printed. For wide type copyboards (model M-11W), the image is compressed about 75% in the lateral direction. To print with the same proportions as the image on the sheet surface, see "Printing in the same ratio as the sheet surface" (page E-23).
- A flashing "E 1" in the display window indicates a print error. See "Meaning of Error Messages" on Page E-34.

## 6

When the copyboard is not going to be used, press the **ON/Standby**  button and switch off the power (standby mode).



- Switch off the printer power.

### Note

- If no button is operated for 30 minutes or greater, the unit is set to the sleep mode and the LEDs on the control panel turn off. If the power button is pressed, the LEDs on the display window turn on. If the print button  is pressed at this time, the printing operation starts.

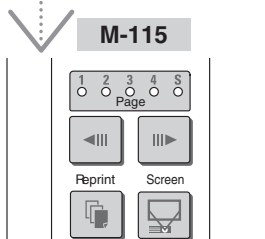
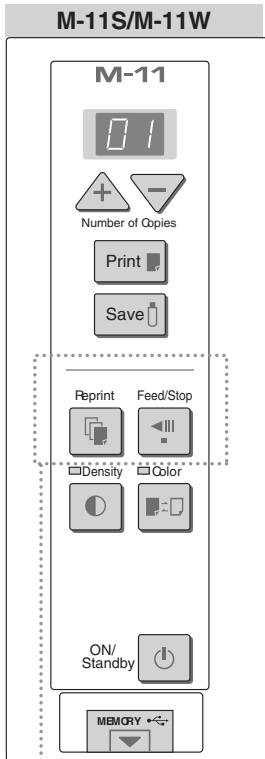

## Selecting the printing density

Select this when the density of the print is light.

Press the Density  button and select darker or standard.

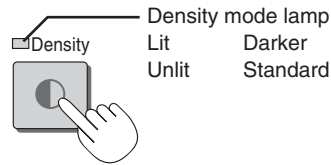

## Making additional copies

This will print the copy of the sheet that was scrolled previously one more time.

Press the Reprint  button.

This starts the printing of the image data that has accumulated in internal memory.

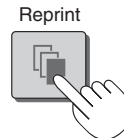

### Note

- The sheet is not scrolled when additional copies are made.
- The number of copies can be changed. To do so, make the change before pressing the Reprint  button.
- In repeat printing, the color/black & white and density settings will be the same as those of the prior printing.
- When printing or USB memory storage has not been performed since switching on the power, image data will not have accumulated in the internal memory and this operation will not be possible.

## Cancellation of the print operation in progress

### During the read operation (when the Print button was pressed)

When the Feed/Stop  button (for model M-115, the ON/Standby button) is pressed, the reading of the sheet stops (for model M-115, the copyboard returns to the original page), and the partially read image data is printed. Wait until the sheet is expelled from the printer.



### Stopping the printing after the Print button was pressed and the reading completed

### Stopping the process when multiple copies are being made when making additional copies (When the Reprint button has been pressed)

Press the copyboard's ON/Standby  button. After several seconds, printing is interrupted and the sheet is expelled.

# Printing

## Specifying the Page (model M-115)

Press the Page change / buttons to make the page indicator for the desired page flash. The sheet is scrolled to that page.

Page indicators

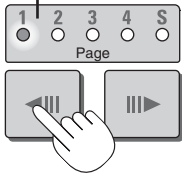

### Page change button

Each time the button is pressed, the page indicators flash in the order 1 → 2 → 3 → 4, the sheet scrolls to the specified page then stops, and the corresponding page indicator stops flashing, remaining lit.

### Page change button

Each time the button is pressed, the page indicators flash in the order S → 4 → 3 → 2 → 1, the sheet scrolls to the specified page then stops, and the corresponding page indicator stops flashing, remaining lit.

### Note

- Scrolling to the screen (S page) is not possible with the page change button.
- The S page cannot be specified by pressing the page change button when at Page 1.
- Page 1 cannot be specified by pressing the page change button when at the S page.
- Holes can be seen moving at the bottom of the sheet while the sheet is scrolling. These holes are normal (the copyboard is not damaged).
- The sheet may not look flat while it is moving. This is normal.

### Notice

- If the display content of the page indicator does not agree with that of the actual page, move the copyboard to either Page 1 or the S page.

## Switching to the screen (model M-115)

You can switch to the screen at the touch of a button. This screen is for use with regular or overhead projectors or other optical devices.

Screen



With the sheet surface at some point between page 1 and page 4, press the Screen button.

When the button is pressed, the “S” page indicator flashes green and the sheet scrolls to the screen. When pressed again, the sheet scrolls back to the page at which it was previously set.

### Note

- When the power is switched off (in standby), or the AC power adapter has been disconnected, pressing the Screen button again will not result in a return to the original page.

### Notice

- The S page is a screen for projecting the images of optical devices. Do not write on it, as ink cannot be erased from this screen. Also note that images projected on this screen cannot be printed or stored in a USB memory device.

## Printing in the same ratio as the sheet surface (Model M-11W)

Model M-11W is the wide type copyboard which will compress printing in the horizontal direction resulting in crowded printing of the A4 or LETTER size sheet; for example, a circle will become an ellipse. To print in the same aspect ratio as a drawn diagram, the compression mode will be changed (to suit the paper size according to the sheet surface image). The factory default setting is the horizontal compression mode.

When the power is on, press the ON/Standby button while holding down the Color button.

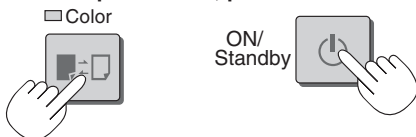

There will be a change to the “equivalent compression mode.” When the mode changes, the Color mode indicator will flash for 5 seconds. To return to the “horizontal compression mode,” perform the same operation.

## Moving the sheet surface manually

The sheet can be moved even when the power of the copyboard is switched off.

The sheet can be moved with your hand either in left or right. Please place your hand at the vertical center and move the sheet slowly. Quick movement can cause damage to the drive mechanism of the copyboard.

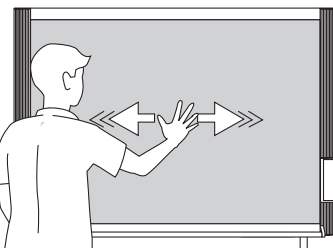

### Note

- For model M-115, do not move the sheet surface by hand. Doing so could damage the copyboard.

# Using USB Memory

The content of what has been drawn on the sheet surface of the copyboard can be saved in USB memory. Later, the saved image can be read into a personal computer and made into a document of the proceedings of the meeting, or affixed to a document.

## • What is needed to use the USB memory function

USB memory: Commercially-available product

Personal computer: The connector is a USB port (type A), and the interface supports USB 1.1

## Note

- The copyboard supports the USB memory formats of FAT 12/16 and FAT 32.

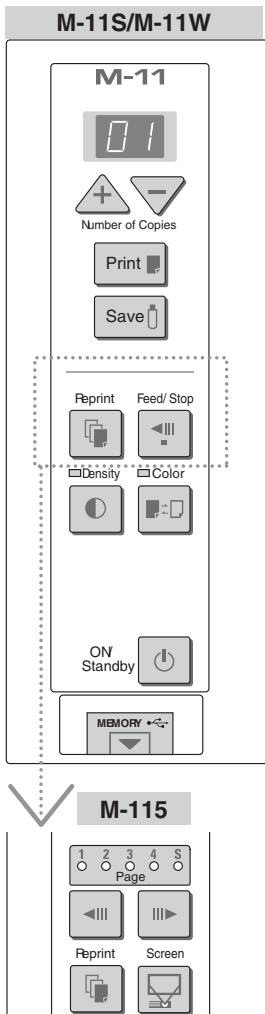

## USB Memory Storage Procedure

### Preparation:



Connect the AC power adapter to the copyboard. See Page E-16.

# 1

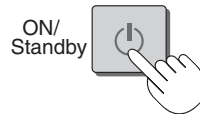
Press the ON/Standby  button and switch on the power.



### Note

- Press the ON/Standby  button more than 5 seconds after connecting the AC power adapter to the copyboard unit or after turning off the power.
- Press the ON/Standby  button to switch on the power. The LED of the display window will light.

# 2

Insert the USB memory device into the Memory  port (USB port) of the copyboard

### Notice

- Check the side (polarity) of the USB memory device before inserting it. Forcing it in the reverse orientation will damage the USB port or USB memory device.
- Be careful not to bump into the USB memory device with hand or body while it is mounted. Doing so could damage the USB memory device or USB port.

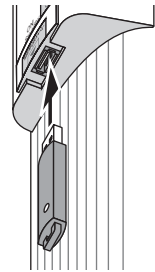

# 3

Press the Feed/Stop  button (for model M-115, the Page change  /  buttons) and display the sheet surface you want to store.



## Notice

- For a description of the USB memory devices usable with this copyboard, please go to our web-site at:

<http://www.plus-vision.com>

The procedure for displaying the sheet surface you want to store is the same as for printing. See "Basic Printing Operation" on page E-20 and "Specifying the Page (model M-115)" on page E-23.

## Note

- The one screen portion that is viewable will be saved in USB memory.
- To make fine adjustments to the sheet surface, when the sheet is stopped, move the sheet slowly by hand. The sheet can be moved either left or right.
- Saving of the portion located around the sheet surface might not be possible. Please see "Effective reading size" on Page E-9.



## Using USB Memory

4

Press the Color  button and select Color or Black & White.

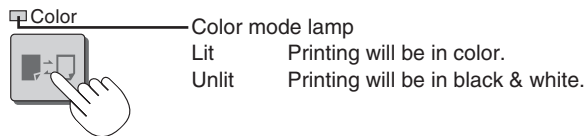

5

Press the Save  button to store

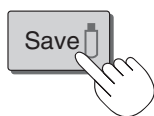

Display window

Flashing indicator “rotates” sequentially during USB memory storage operation.

- The reading operation is performed for a one-sheet portion (while the sheet is scrolled) and USB memory storage starts after the scrolling completes.









The (5 second) flashing “US” display indicates that the USB memory has not been inserted. Please insert the USB memory and then press the Save  button.



The (5 second) flashing “FL” display indicates that the USB memory is full. The flashing display will stop when the USB memory device is removed. Replace with a USB memory device having sufficient capacity.

See “Meaning of Error Messages” on Page E-34 for other error displays.

### Note

- For some USB memories, some time may be required for recognition.
- If the Feed/Stop  button (for model M-115, the Power button) is pressed while the data is being read, the operation for storing the data in the USB memory device is canceled and the image data loaded up to that point is stored.  
To move the sheet surface, wait until scrolling stops, then press the Feed/Stop  button (for model M-115, the Page change  /  buttons).
- For model M-115, the image projected on the S page (screen) cannot be stored in the USB memory device.
- A press of the Print  button during USB memory storage starts the printing after storage is completed.
- When the wide type (M-11W) copyboard has been adjusted to the paper size in the horizontal direction, the image will be compressed to about 75%.
- The date and time of the saved file will reflect the copyboard time setting. See “Setting the Time” on Page E-17.
- If there is not enough space, the memory card is judged to be full from the start. If the memory card runs out of space while a file is being saved, “FL” is displayed at that point. Delete data, set the sheet surface back to the original status, then press the Save  button again.

### Removing the USB memory device

Check that the rotating flashing indicators of the display window have changed to being lit steadily, then pull the USB memory device straight out.

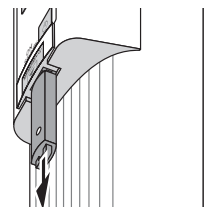

### Notice

- Do not unplug the USB memory device during the USB memory storage operation (i.e., during the rotating, flashing display in the display window), or while the access indicator of the USB memory device is flashing because data will be destroyed.

6

When the copyboard is not going to be used, press the ON/Standby  button and switch off the power (standby mode).



### Note

- “USB” letters appearing at one-second intervals in a moving display in the display window indicate that a USB memory device is mounted. Unplugging the USB memory device will switch off the power. (A function that serves as a reminder to unplug the USB memory device)
- If no button is operated for 30 minutes or greater, the unit is set to the sleep mode and the LEDs on the control panel turn off. If the power button is pressed, the LEDs on the display window turn on. If the save button is pressed at this time, storing of the data in the USB memory device starts.

### Saving Image Files to a Personal Computer, and Deleting Image Files

Examples of operations follow for saving the image files in the USB memory device to the hard disk of the personal computer, and for deleting the folder when the USB memory capacity is full. (There are various methods that can be used for saving and deleting including the use of Explorer.) See the instruction manual of your personal computer or the software that you are using for information about using a personal computer.

The folder name of the copyboard inside USB memory is M-11. Image files are stored in this folder. Image file names are stored as PV-xxxxxx.png (a PNG file) and PV-xxxxxx.htm (an HTML file). "xxxxxx" stands for the date and number (e.g., PV-06110801.png, PV-06110801.htm).

#### Notice

To obtain a display and printing that matches the screen size, open the HTML file in a browser and use the browser.

#### Note

The HTML file and PNG file are associated; therefore, use them as a pair when moving or copying to a separate folder.

## 1

### Plug the USB memory device into a USB port of the personal computer

When connecting to the personal computer for the first time, the installation of a USB driver is required. Follow the instructions manual of the USB memory device that you are using.

- Usually, with Windows 2000/XP the standard driver is installed automatically and is identified as "Removable disk" in "My Computer."

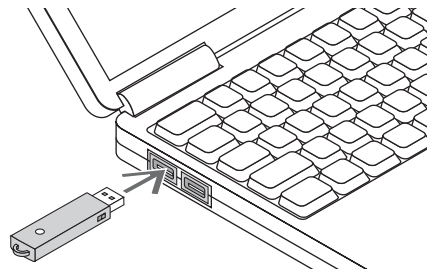

## 2

### Saving the image files of a USB memory device to a personal computer

1. Open "My Computer" and from within, open the drive of the connected USB memory device.

The folder named "M-11" is the saved data of the copyboard.

2. Store the "M-11" folder in "My Documents" or another location.

All of the data contained in "M-11" will be stored.

#### Notice

Depending on the computer's usage environment, these operations may not work properly. This could be the case for example:

- when several USB devices are connected simultaneously to the computer.
- when the USB device is connected to a USB hub or when it is connected using an extension cable.

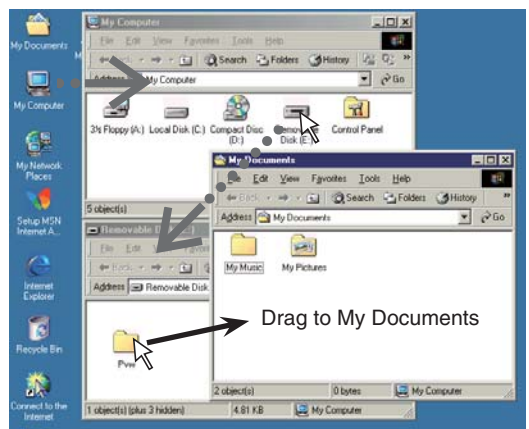

## Deleting USB memory image files with the computer

Before deleting important image files, be sure to save them on the computer (as a data backup).

**1. Open “My Computer” and then open the drive icon which shows memory card.**

The folder named “M-11” contains the memory storage data of the copy-board.

**2. Place the “M-11” folder in the “Recycle Bin”, right click on the icon and select “Empty Recycle Bin” from the pull-down menu.**

All of the data contained in “M-11” will be deleted.

Even when the entire folder is deleted, a new M-11 folder will be created automatically when USB memory is used again with the copyboard.



### 3

## Disconnect the USB memory

The disconnecting procedure depends on the computer's operating system. For details, refer to the computer's operating instructions or help files.

**1. Click the [Hardware Removal] icon that is displayed in the task tray.**

Click “Stop USB Mass storage Device - drive (E)”. (The E drive character will differ depending on the personal computer system.)

**2. Click [OK] when “The ‘USB Mass storage Device’ device can now be safely removed from the System” is displayed.**

(When using Windows XP, [OK] does not appear on the message screen. Simply disconnect.)

**3. This allows the USB memory device to be unplugged from the computer.**

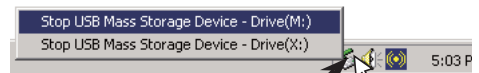

“Remove hardware” icon (example)



### Note

- Do not disconnect the USB memory device while the USB memory device's access indicator is flashing. Doing so will damage the data.
- The USB drive may not be disconnected properly, for example if the computer is in the process of checking the status of peripherals.

# Supplied Software Setup Guide

The supplied CD-ROM contains the software and manuals described below. See the Help information of the various software programs for information about how to use the software.

## Software Contents and Overview

### • USB Driver

This driver software allows the computer to recognize the Copyboard as an external device when there is a USB connection. Be sure to install this USB driver when connecting the PC dedicated USB port with the computer.

### • TWAIN Driver

This drive is used to acquire the scanned data into a computer as an image.

\* This driver may not work on some applications.

\* This driver conforms to TWAIN standard (ver. 1.9).

### • Setup Utility

This is a utility for customizing the M-11's environmental settings.

### • User's Manual

The User's Manual is stored on the CD-ROM in PDF format.

If Acrobat Reader is not installed on the PC, click "Acrobat Reader" on the menu and install it according to the instructions on the screen.

### • PLUS Image Viewer

This utility is used to display the images stored in a personal computer or print it out.

### • Acrobat Reader

This software is used to view PDF files.

### • Browsing the CD-ROM

Explorer running on the personal computer is used to display the contents of the CD-ROM.

### • Copyrights and usage conditions

This opens the copyrights, usage conditions, etc.



---

### Note

- When installing on Windows 2000, please install the software with "Administrator" authority (i.e., a user having administrator authority).
- When installing on Windows XP, please install the software with "Computer Administrator" authority (account).

---

### Notice

- The help of the PLUS Image Viewer uses the online help system that is used for Microsoft HTML Help.

---

## Operating Environment

Supported OS:	Microsoft Windows 2000 Professional (Service Pack 4 or later)/ XP (HomeEdition / Professional Edition Service Pack 2 or later)
Supported PC:	IBM PC/AT or completely compatible machines that operate the aforementioned OS
CPU:	Pentium II or later
Memory:	Windows 2000 (128 MB or bigger), Windows XP (256 MB or bigger)
Free hard disk space:	40 MB or bigger
Display resolution:	800 × 600 pixels or higher
Peripheral devices:	a CD-ROM /DVD-ROM drive, a standard USB port (USB 1.1 or 2.0)
Web browser:	Internet Explorer 6.0 or later

---

### Notice

- All operations are not guaranteed under the aforementioned operating environment.
- Not compatible with Windows 95, 98SE, Me, NT, 2000 Server or Server 2003.

## Installing the USB driver

When connecting the copyboard's PC dedicated USB port to the USB port of the computer, it is necessary to install the accompanying USB driver to allow the computer to recognize the copyboard as an external device and permit reading and writing.

Once installed on the computer, there will be no need to install it again.

---

1

### Turn on the computer's power and start up Windows.

Logon using an account that has administrator privileges which allows making changes to system settings.

---

2

### Turn on the copyboard's power and connect it to the computer using the USB cable.

Use the supplied (or a commercially available) USB cable to connect the PC dedicated USB port on the bottom of the copyboard with the USB port of the computer.

---

**Note**

- Use a USB-IF certified shielded USB cable.
- 

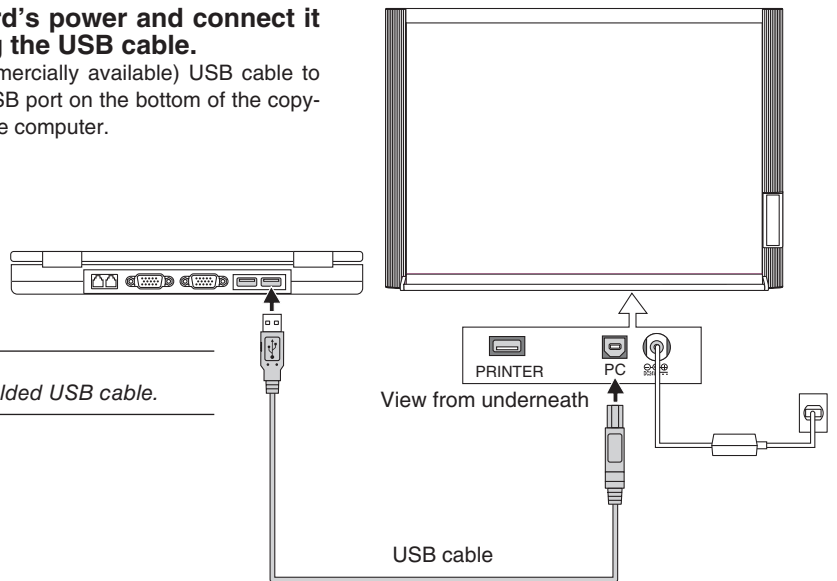

---

3

### When the "New hardware wizard" starts, click the "Next" button.

---

4

When "M-11 USB Device" is detected, select "Search for a suitable driver for my device (recommended)" (Windows 2000), or "Install from a list or specific location (Advanced)" (Windows XP), then click the "Next" button.

---

5

### Set the included CD-ROM in the CD-ROM drive.

If the setup window appears, click the "x" (close) button to close it.

---

6

Select only "Specify a location where to search", then click the "Next" button (Windows 2000), or select only "include this location in the search" (Windows XP).

---

7

Specify “D:\M11USB” (D is the designation of the CD-ROM drive) in the text box and click the “Next” button.

8

Once the driver is found, click the “Next” button.

9

Once installation of the USB compatible device’s driver is complete, click the “End” button.

**This completes the installation.**

Perform the USB device disconnection procedure at the computer side before disconnecting the USB cable. See “Disconnecting USB Connections with the Main Unit” on Page E-33.

---

### Acquiring images of the copyboard directly by the computer

Start the reading operation of the copyboard from the computer side, and send directly to the computer the image data that has been read. This will allow display and printing. To make use of this function, install the supplied "PLUS Image Viewer" and "TWAIN Driver" on the computer.

#### Installation

---

# 1

#### Preparations for installation

Quit any applications that are currently running on the computer. If not, installation may not be completed properly.

---

# 2

#### Set the included CD-ROM in the CD-ROM drive.

The menu window appears automatically.

If the menu window does not appear automatically, open the CD-ROM folder and double-click on "autorun.exe".

---

# 3

#### Select the menu and click.

- When "Image Viewer" is clicked, the TWAIN driver is installed simultaneously.
- When "TWAIN driver" is clicked, only the TWAIN driver is installed.

---

#### Note

- *When using a TWAIN compatible application, these operations are possible even if only the TWAIN driver is installed.*

---

- **The installer will start up when clicked.**

Follow the messages displayed on the screen to install.

Once installation is completed, "Restart computer now?" appears. Click "Yes" to restart the computer.

**This completes the installation.**

---

### Acquire copyboard images on the computer using the PLUS Image Viewer

#### Preparation and Check

1. Has the installation of the USB driver on the supplied CD-ROM been completed? (Page E-29)
2. Has the connection been made between the copyboard's PC dedicated USB port and the USB port of the computer? (Page E-29, step 2)
3. Has installation of the aforementioned "TWAIN Driver" and "PLUS Image Viewer" been completed?

---

# 1

#### Starting the "PLUS Image Viewer"

On the computer, choose "Start" → "Programs" → "PLUS Copyboard" → "PLUS Image Viewer".

The PLUS Image Viewer starts up.

- For details on using Image Viewer, see "PLUS Image Viewer Help".

---

# 2

#### Click "TWAIN source" on the "File" menu.

---

# 3

#### Select "PLUS Copyboard M-11", then click "Select".

---

# 4

#### Click "TWAIN Acquire" on the "File" menu.

The control panel will be displayed on the screen.

If the control panel does not appear, check the connection of the USB cable and the copyboard's status.

---

Continued on next page

## Supplied Software Setup Guide

---

5

### Click the “Save to PC” button of the on-screen control panel.

The sheet of the copyboard will scroll and reading will begin.

When reading is completed, the image of the sheet surface that has been read will be displayed on the computer screen.

#### Notice

- Do not drag the on-screen control panel or operate other software during processing, as doing so could hamper the reading operation.

6

### Click the “Close” button of the on-screen control panel to exit.

The control panel will disappear and the reading process will be completed.

When disconnecting the USB cable, first perform the USB disconnection procedure at the computer side. See “Disconnecting USB Connections with the Main Unit” on Page E-33.

## Using the Setup Utility

The copyboard’s operating environment can be changed using the Setup Utility.

Content: “binding margin” setting, time setting, enabling/disabling of timestamp, printing/saving mode, paper mode, and image aspect ratio

### Installation

1

#### Preparations for installation

Quit any applications that are currently running on the computer. If not, installation may not be completed properly.

2

#### Set the included CD-ROM in the CD-ROM drive.

The menu window appears automatically.

If the menu window does not appear automatically, open the CD-ROM folder and double-click on “autorun.exe”.

3

#### Click “Setup Utility” on the menu

The installer is launched. Follow the messages displayed on the screen to install.

The installation will finish, and if “Restart the computer now” is displayed, select “Yes” to restart the computer.

**This completes the installation.**

## Starting the Setup Utility

### Preparation and Check

1. Has the installation of the USB driver on the supplied CD-ROM been completed? (Page E-29)
2. Has the connection been made between the copyboard’s PC dedicated USB port and the USB port of the computer? (Page E-29, step 2)
3. Has installation of the aforementioned “Setup Utility” been completed? Once installed, there is no need to install it again.

1

#### Starting the Setup Utility

On the computer, choose “Start” → “Programs” → “PLUS Copyboard” → “M-11 Setup Utility”.

The Setup Utility starts up.

\*For details on using the Setup Utility, see “M-11 Setup Utility Help”.

Perform the USB device disconnection procedure at the computer side before disconnecting the USB cable. See “Disconnecting USB Connections with the Main Unit” on Page E-33.



### Disconnecting USB Connections with the Main Unit

Perform the USB device disconnection procedure at the computer side before disconnecting the USB cable between the main unit and the computer.

The disconnection operation will differ depending on the operating system (OS) of the computer. See the computer instruction manual or on-screen Help for details.

---

**1 Click the [Hardware Removal] icon  that is displayed in the task tray.**

Click "Stop M-11 USB Device".

**2 Click [OK] when "The 'PLUS Copyboard M-11 USB Device' device can now safely removed from the System" is displayed.**

(When using Windows XP, [OK] does not appear on the message screen. Simply disconnect. )

---

**Note**

- *The USB drive may not be disconnected properly, for example if the computer is in the process of checking the status of peripherals.*

---

### Uninstalling the software

If you no longer need software you have installed, use the procedure below to uninstall it.

---

**1**

**Select "Start" → "Control Panel".**

The control panel window is displayed.

---

**2**

**Double-click "Add/delete programs or applications" (the name differs according to the operating system).**

The "Program add/delete properties" window appears.

From the list, select the program you want to delete (uninstall), then click "Change/Delete". The add/delete wizard window appears.

---

**3**

**Select the "Remove" button on the wizard window, then click "Next".**









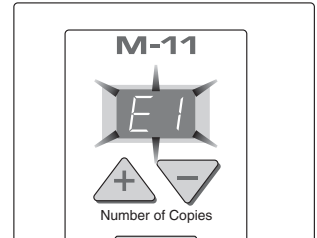

Uninstalling starts.

\* Use "Add/delete applications" for Windows XP.

# Meaning of Error Messages

If any of the following flashing indications appear in the display window of the control panel, please check the matters described below. The flashing will continue for 5 seconds. Error messages will flash for 5 seconds; however, error displays of “E4” and “E5” will be lit steadily after the flashing stops.



Error Display Number	Problem and Solution	
 <b>Printer not connected</b> <b>No printing paper</b> <b>Printer problem</b>	<ul style="list-style-type: none"> <li>Is the printer cable connected?</li> <li>Is power being supplied to the printer?</li> <li>When the printer uses an AC power adapter, is the cable disconnected somewhere?</li> </ul>	<ul style="list-style-type: none"> <li>Connect the printer properly and switch on the printer power.</li> </ul>
	<ul style="list-style-type: none"> <li>Has paper been set in the printer?</li> </ul>	<ul style="list-style-type: none"> <li>Insert A4 or Letter size paper into the printer.</li> </ul>
	<ul style="list-style-type: none"> <li>Is the printer error indicator flashing (or lit)?</li> </ul>	<ul style="list-style-type: none"> <li>Read the printer instruction manual.</li> </ul>
 <b>USB Memory not recognized</b>	<ul style="list-style-type: none"> <li>Is the USB memory unformatted.</li> </ul>	<ul style="list-style-type: none"> <li>This unit supports the FAT 12/16 and FAT 32 formats. Perform the formatting with the personal computer.</li> </ul>
	<ul style="list-style-type: none"> <li>Is a USB memory that is not supported by the copyboard being used?</li> </ul>	<ul style="list-style-type: none"> <li>Please see our home page for information about USB memories that can be used with the copyboard. ( <a href="http://www.plus-vision.com">http://www.plus-vision.com</a> )</li> </ul>
	<ul style="list-style-type: none"> <li>Is the USB memory device plugged in fully?</li> <li>Is the USB memory damaged?</li> </ul>	<ul style="list-style-type: none"> <li>Please check the operation with a personal computer.</li> </ul>
 <b>USB Memory storage problem</b>	<ul style="list-style-type: none"> <li>An error occurred during USB memory storage.</li> </ul>	<ul style="list-style-type: none"> <li>Please perform USB memory storage again.</li> <li>Do not insert or remove the USB memory during processing.</li> </ul>
 <b>Reading problem</b>	<ul style="list-style-type: none"> <li>There is a lighting fault of the reading light source, or a read signal error.</li> </ul>	<ul style="list-style-type: none"> <li>Unplug the power plug from the power outlet and then plug it in again.</li> </ul>
 <b>System error</b>	<ul style="list-style-type: none"> <li>There is a memory or internal fault.</li> </ul>	<ul style="list-style-type: none"> <li>Unplug the power plug from the power outlet and then plug it in again.</li> </ul>
 <b>Page detection error (model M-115 only)</b>	<ul style="list-style-type: none"> <li>The pages are not being properly detected.</li> </ul>	<ul style="list-style-type: none"> <li>Unplug the power plug from the power outlet and then plug it in again.</li> </ul>
 <b>USB memory not connected</b>  <b>When the “USB” letter display is flowing...Warning that disconnection of USB memory has been forgotten</b>  	<ul style="list-style-type: none"> <li>USB memory device is not plugged into the main unit.</li> <li>Did you press the ON/Standby button while the USB memory device was plugged into the main unit?</li> </ul>	<ul style="list-style-type: none"> <li>Plug the USB memory device into the USB port.</li> <li>A USB memory device is plugged into the main unit. When the USB memory device is disconnected, the power will be switched off and the unit will enter the standby mode.</li> </ul>
 <b>USB Memory is full</b>	<ul style="list-style-type: none"> <li>There is no available space.</li> </ul>	<ul style="list-style-type: none"> <li>Please delete unnecessary data using a personal computer (See Page E-27).</li> </ul>
 <b>An unsupported printer is connected</b>	<ul style="list-style-type: none"> <li>A printer that is not supported by the copyboard has been connected.</li> </ul>	<ul style="list-style-type: none"> <li>Press the ON/Standby button and switch off the power. When a record is required, switch on the power and save to USB memory.</li> </ul>

If the problem persists, please contact your nearby PLUS Vision sales office, dealer, or store.

# Troubleshooting

Please check the following matters before making a request for servicing.



	Condition	Please Check
<b>Copyboard Related</b>	Pressing the ON/Standby  button does not switch on the power.	<ul style="list-style-type: none"> <li>Check whether the cable of the AC power adapter is disconnected from the DC connector of the copyboard or the wall outlet.</li> </ul>
	Writing on the sheet is not erased with the eraser.	<ul style="list-style-type: none"> <li>Was a marker other than a special marker used? (Moisten a cloth with water or neutral detergent, wring well, and wipe carefully.)</li> </ul>
	Portions of writing or lines are not printed or stored in memory.	<ul style="list-style-type: none"> <li>Portions of blurred characters or thin lines may not be printed or stored in USB memory.</li> <li>Change Density setting to "Dark".</li> </ul>
	The copy is soiled. (The image data is dirty at the time of printing, USB memory storage, or personal computer saving.)	<ul style="list-style-type: none"> <li>Is there a lot of marker refuse adhering to the sheet? (When soiled, moisten a soft cloth with water, wring well, and wipe the sheet in a stroking manner.)</li> </ul>
	The ruled line of the sheet appears on the print or in the file of the USB memory, or the black ink mixes into other color in the case of Color Mode.	<ul style="list-style-type: none"> <li>Check the density indicator, and select standard density if the setting is darker.</li> </ul>
	When the copyboard and PC are connected, the supplied utility program does not operate after installation of the USB driver	<ul style="list-style-type: none"> <li>Has the USB driver in the CD-ROM been properly registered in the device manager? (An exclamation mark (!) will be affixed if it has not been registered.) (If not registered, delete the USB driver and reinstall it.)</li> </ul>
	When the copyboard and PC are connected, the PC does not recognize the copyboard	<ul style="list-style-type: none"> <li>Check whether the copyboard is in an operable condition, and whether the USB cable is connected properly.</li> <li>Is the copyboard connected to the PC via a USB hub? (Connect the copyboard directly to the USB port of the PC.)</li> </ul>

\* If the problem persists, please contact your nearby PLUS Vision sales office, dealer, or store.

	Condition	Please Check
<b>Printer Related</b>	A press of the Print  button does not result in printing.	<ul style="list-style-type: none"> <li>Check that the power cable of the printer and the printer cable are securely connected.</li> <li>Check that the printer power indicator is lit.</li> <li>Check that the error indicators of the copyboard and the printer are not lit.</li> <li>If the error indicator of the copyboard is flashing, please see Page E-34. (Please see the printer instruction manual for information about printer errors.)</li> </ul>
	The paper feed is abnormal.	<ul style="list-style-type: none"> <li>Possible causes include damp paper, overly thin or thick paper, only one sheet of paper is set, and a curved setting of the paper. (Please see the instruction manual for your printer.)</li> </ul>
	An altered color is printed, not the specified color.	<ul style="list-style-type: none"> <li>Please replace the print cartridges with new ones.</li> </ul>
	There is no printing.	<ul style="list-style-type: none"> <li>Check that the print cartridge is properly set.</li> <li>Check that the print cartridge is not plugged.</li> </ul>

\* Please see your printer manual for information about printing problems, printer maintenance, and details related to printing.

# Specifications

BOARD TYPE (Model name)		Standard (M-11S)	Wide (M-11W)	5-surface (M-115)
Form	Installation method	Self-standing (T-shaped legs), or wall mounting		
	External dimensions (T-shaped legs*1)	W1470 × D700 × H1970*2 mm	W1970 × D700 × H1970*2 mm	W1470 × D700 × H1970*2 mm
	Main unit weight	29.0 kg*3	33.0 kg*3	33.0 kg*3
	T-shaped legs weight	9.6 kg		
BOARD	Panel Size	H920 × W1300 mm	H920 × W1800 mm	H920 × W1300 mm
	Effective reading size	H900 × W1280 mm	H900 × W1780 mm	H920 × W1280 mm
	Number of Pages	2		5 (4 sheet surfaces + 1 screen surface)
	Paging	Endless in one direction (Horizontal scrolling)		Wind-up type
	Drive method	Sheet movement		
	Reading method	CCD sensor reduction optical system		
	Reading illumination light source	RGB LED		
	Reading resolution	Main scanning direction (vertical sheet surface) 2.4 dots/mm (60 dpi or equivalent) Sub scanning direction (horizontal sheet surface) 2.4 dots/mm (60 dpi or equivalent)		
Memory	Type	USB Flash memory		
	Compatible FAT types	FAT 12, 16, 32		
	File format	PNG format and associated HTML format		
	Interface	USB1.1 or USB2.0 full-speed mode*4		
Control panel	Control buttons	ON/Standby, +, -, Print, Save, Reprint, Color, Density, Feed/Stop		ON/Standby, +, -, Print, Save, Reprint, Color, Density,  ,  (Page Change), Screen
	LED Indicators	Density, Color		Density, Color, Page LEDs
	Display	7-Segment (Page, Error#),		
Added functions	Clock	Used for the timestamp and for file dating properties (Includes backup battery for when there is a loss of power)		
	PC connection	Transfer of sheet surface image data via USB (TWAIN supported)		
Power supply	AC power adapter	Input : AC100–240V/50–60 Hz, Max 1.5 A Output : DC 24 V, 2.71 A		
Operating conditions	Temperature:	10–35°C		
	Humidity:	30–85% (No condensation)		
Recording Section	Printer interface	USB1.1 or USB2.0 full-speed mode*4 compliant printers are supported		
Miscellaneous	Ruled lines	50 mm cross-ruled squares		
	Miscellaneous	Special markers (black, red, blue, and green)		

## Remarks

- \*1: The height is adjustable at 1770, 1870 and 1970 mm.
- \*2: The value indicated for “H” (height) is the maximum height.
- \*3: Not including the weight of the printer.
- \*4: Not correspond High-speed mode.

- Please note that for quality improvement purposes, specifications and design are subject to change without prior notice.
- Depending on the product, the printer and T-shaped legs (stand) will be available separately.

## Free Manuals Download Website

<http://myh66.com>

<http://usermanuals.us>

<http://www.somanuals.com>

<http://www.4manuals.cc>

<http://www.manual-lib.com>

<http://www.404manual.com>

<http://www.luxmanual.com>

<http://aubethermostatmanual.com>

Golf course search by state

<http://golfingnear.com>

Email search by domain

<http://emailbydomain.com>

Auto manuals search

<http://auto.somanuals.com>

TV manuals search

<http://tv.somanuals.com>