

USER'S MANUAL

UP-1100

English

PLUS

IMPORTANT SAFETY INFORMATION

Precautions

Please read this manual carefully before using your PLUS UP-1100 Data Projector and keep the manual handy for future reference.

Your serial number is located next to the main power switch on the back of your UP-1100. Record it here: _____

CAUTION

TO PREVENT SHOCK, DO NOT OPEN THE CABINET. NO USER-SERVICEABLE PARTS INSIDE. REFER SERVICING TO QUALIFIED PLUS SERVICE PERSONNEL.

WARNING

TO PREVENT FIRE OR SHOCK, DO NOT EXPOSE THIS UNIT TO RAIN OR MOISTURE. DO NOT USE THIS UNIT'S GROUNDED PLUG WITH AN EXTENSION CORD OR IN AN OUTLET UNLESS ALL THREE PRONGS CAN BE FULLY INSERTED. DO NOT OPEN THE CABINET. THERE ARE HIGH-VOLTAGE COMPONENTS INSIDE. ALL SERVICING MUST BE DONE BY QUALIFIED PLUS SERVICE PERSONNEL.

RF Interference

WARNING

The Federal Communications Commission does not allow any modifications or changes to the unit EXCEPT those specified by PLUS Technologies in this manual. Failure to comply with this government regulation could void your right to operate this equipment.

This equipment has been tested and found to comply with the limits for a Class A digital device, pursuant to Part 15 of the FCC Rules. These limits are designed to provide reasonable protection against harmful interference in a commercial installation. This equipment generates, uses and can radiate radio frequency energy and, if not installed and used in accordance with the instructions, may cause harmful interference to radio communications. Operation of this equipment in a residential area is likely to cause harmful interference in which case the user will be required to correct the interference at their own expense.

DOC Compliance Notice

This Class A digital apparatus meets all requirements of the Canadian Interference-Causing Equipment Regulations.

Important Safeguards

These safety instructions are to ensure the long life of your Data projector and to prevent fire and shock. Please read them carefully and heed all warnings.

Installation

- For best results, use your Data projector in a darkened room.
- Place the projector on a flat, level surface in a dry area away from dust and moisture.
- Do not place your Data projector in direct sunlight, near heaters or heat radiating appliances.
- Exposure to direct sunlight, smoke or steam can harm internal components.
- Handle your Data projector carefully. Dropping or jarring can damage internal components.
- Do not place heavy objects on top of the Data projector.
- If installing the Data projector in the ceiling:
 - The ceiling must be strong enough to support the Data projector and the installation must be in accordance with any local building codes.
 - The Data projector must be installed by qualified PLUS service personnel.

Power Supply

- The Data projector is designed to operate on a power supply of 100 to 120 or 220 to 240 V 50/60 Hz AC. Ensure that your power supply fits this requirement before attempting to use your Data projector.
- Handle the power cable carefully and avoid excessive bending. A damaged cord can cause electric shock or fire.
- If the Data projector is not to be used for an extended period of time, disconnect the plug from the power outlet.

Cleaning

- Unplug the Data projector before cleaning.
- Clean the cabinet periodically with a damp cloth. If heavily soiled, use a mild detergent. Never use strong detergents or solvents such as alcohol or thinner.
- Use a blower or lens paper to clean the lens, and be careful not to scratch or mar the lens.

Lamp Replacement

- Be sure to replace the lamp when the Status light comes on. If you continue to use the lamp after 1000 hours of use, the lamp will turn off.
- Allow a minimum of one minute to elapse between turning the lamp off and on. High voltage is applied to the lamp immediately when the power is turned on. Therefore turning the power off and quickly back on may shorten the life of your lamp and result in damage to your Data projector.

Fire and Shock Precautions

- Ensure that there is sufficient ventilation and that vents are unobstructed to prevent the buildup of heat inside your Data projector. Allow at least 10cm (3 inches) of space between your Data projector and a wall.
- Prevent foreign objects such as paper clips and bits of paper from falling into your Data projector. Do not attempt to retrieve any objects that might fall into your projector. Do not insert any metal objects such as a wire or screwdriver into your Data projector. If something should fall into your projector, disconnect it immediately and have the object removed by a qualified PLUS service person.
- Do not place any liquids on top of your Data projector.
- **Do not look into the lens while the projector is on. Serious damage to your eyes could result.**

Carrying around

When carrying this device around, please use the carrying case that comes with it and to protect the lens from scratches, always attach the lens cap. Also, do not subject the projector main unit to strong mechanical shock.

IMPORTANT SAFETY INFORMATION	2
Table of contents	3

Basic information and preparations 4

About your UP-1100	4
Checking the supplied accessories	4
Preparing the remote control	5
Parts and controls	6
Installation	9

Connections 11

Connecting video equipment	11
Connecting a PC or Macintosh	12
Using the remote control as a computer mouse	
–Wireless mouse function	14
Additional connections	15

Operation 16

Using the Data Projector	16
Various functions while using the Data Projector	19

Menu operation 21

Basic operation (Selecting the input source)	21
Menu structure	22
Selecting the projection type	24
Selecting a display language	24
Adjusting the volume	24
Selecting the background	24
Setting “INPUT MODE” to “YCbCr”	24
Adjusting the image from the source connected to the RGB IN connector	25
Adjusting the picture elements	27
Selecting the picture type	28
Selecting the wide screen display	28
Activating the power saving function	28
Quick starting the unit	28
Activating the on-screen function	29
Checking hours of lamp use	29
Resetting all to the factory settings	29

Others 30

Troubleshooting	30
When the STATUS indicator lights or blinks	31
Replacing the lamp housing	32
Specifications	33

About your UP-1100

Congratulations On Your Purchase Of The UP-1100 Data Projector

The UP-1100 is one of the very best Data projectors available today. The UP-1100 enables you to project precise images up to 300 inches across (measured diagonally) from your PC or Macintosh computer (desktop or notebook), VCR, document camera, laser disc player, DVD player, etc.

The Data Projector can be placed on a tabletop or cart, or permanently mounted on the ceiling*. You may use the Data Projector to project images from behind the screen. The supplied remote control can be used as wireless or wired control and with the supplied mouse receiver to operate the mouse functions on your PC or Macintosh.

* Installing the UP-1100 Data Projector on the ceiling must be done by authorized PLUS technicians. Consult your dealer for more information.

The features you'll enjoy

- **Compatible with following various color systems:**

- NTSC (U.S. and Canada standard)
- PAL (Western Europe standard)
- SECAM (France and Eastern Europe standard)
- NTSC4.43 (Middle East country standard)

- **Superior brightness of 1000 ANSI lumens with A4 size and 4.8 kilograms**

The DMD and our own optical design interact in a geometric effect to increase the light usage efficiency. Now you can reproduce the 3 basic colors (RGB) required for color reproduction on a single DMD. That means superior brightness, smaller size and lighter weight.

- **Sharp, clear images**

There is no RGB color separation, and the spaces between the individual pixels are not noticeable. That means sharp and clear reproduction of small characters and figures. Take a closer look and notice the difference in quality!

- **Outstanding beauty when reproducing DVDs and other high picture-quality information sources**

Faithful gray scale reproduction makes for more natural image displays. DVD and other high quality image sources bring out the true display capacity of the Data Projector.

- **Screen not distorted to a trapezoid (keystoning) when projecting to the height of the line of vision**

Because the projection position is already set to the height of the line of vision, there is no distortion of the screen to a trapezoid.

- **Fully compatible with true XGA; support for SXGA using advanced intelligent compression technology**

The advanced intelligent compression technology of the UP-1100 enables it to present clear compression SXGA images without any line omission.

- **The remote control which can be used with or without a cable and even as a remote mouse control to operate your PC or Macintosh by connecting the supplied remote mouse receiver**

You can control both the Data Projector and computer with the single remote control at the same time.

- **The compact and easy to carry cabinet with its contemporary design complements any office, board room, or auditorium.**

Checking the supplied

Make sure your box contains everything listed below. If any pieces and packing materials if you ever need to ship your UP-1100 Data The number of accessories is indicated in brackets.

For remote control

Remote control [1]

Batteries (size AA/R6) [2]

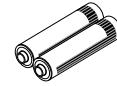
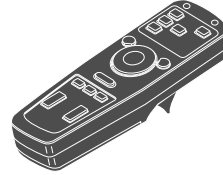

For video equipment connection

Audio video cable (2m) [1]

S-video cable (2m) [1]

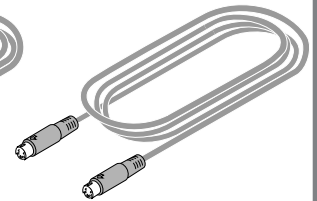
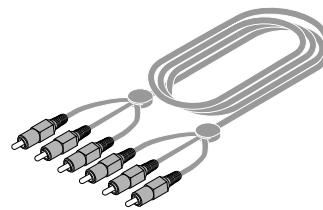

When using the remote control as computer mouse

Remote mouse receiver [1]

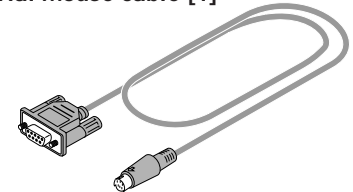
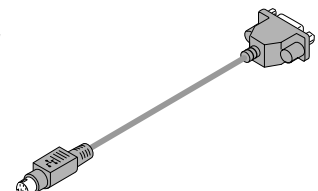
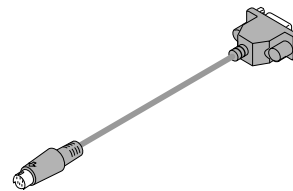
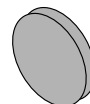

Serial mouse cable [1]

Mouse adapter
(for IBM PS/2) [1]Mouse adapter
(for Macintosh) [1]Lens cap (attached to
the lens of the unit) [1]USER'S MANUAL (this
manual) [1]

accessories

are missing, contact your dealer. Please save the original box Projector.

Wired remote control cable (4m) [1]

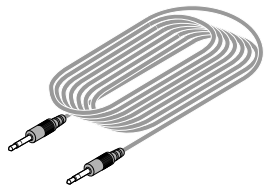

For computer connection

PC/Macintosh multicable (2m) [1]

Monitor adapter (for Macintosh) [1]

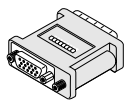
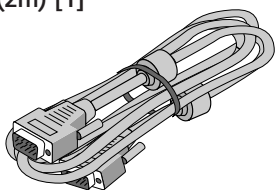

PC audio cable (2m) [1]

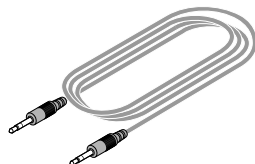

Power cable (mains lead) (4m) [1]

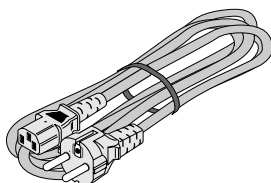

Carrying case [1]

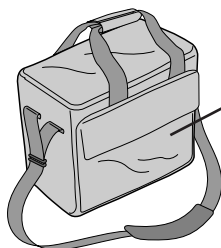

Accessory pocket

How to use the carrying case

Main unit

The bottom of the unit should face this side.

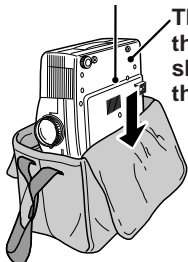

Notebook computer and accessories

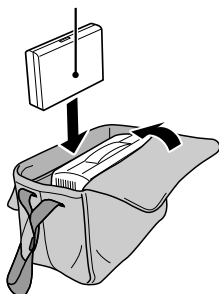

Preparing the remote control

Inserting the batteries

- 1 Press firmly and slide the battery cover off.

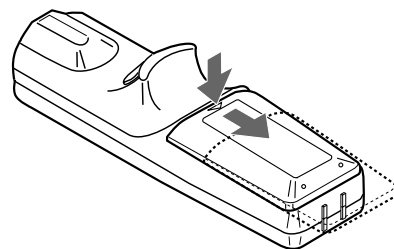

- 2 Insert the supplied two batteries (size AA/R6). Ensure that the polarities (+ and -) of the batteries are aligned correctly.

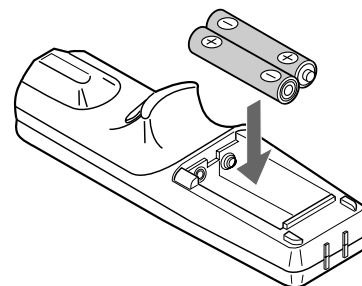

- 3 Slip the cover back over the batteries until it snaps into place.

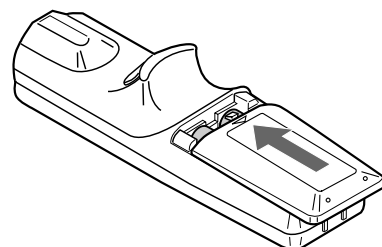

Notes

- If the remote control gets wet, wipe it dry immediately.
- Avoid excessive heat and humidity.
- If you will not be using the remote control for a long time, remove the batteries.
- Do not mix new and old or different types of batteries.
- There are operations that can only be carried out by remote control. Handle the remote control carefully.

Remote control effective range

Each side of the unit has a remote sensor as illustrated below.

The controllable range is 50 degrees horizontally and 30 degrees vertically relative to a line that is at a right angle to the remote sensor. And the distance between the point of the remote control and remote sensor must be shorter than four meters.

Tip

You can also use the remote control as a wired remote control (see page 15).

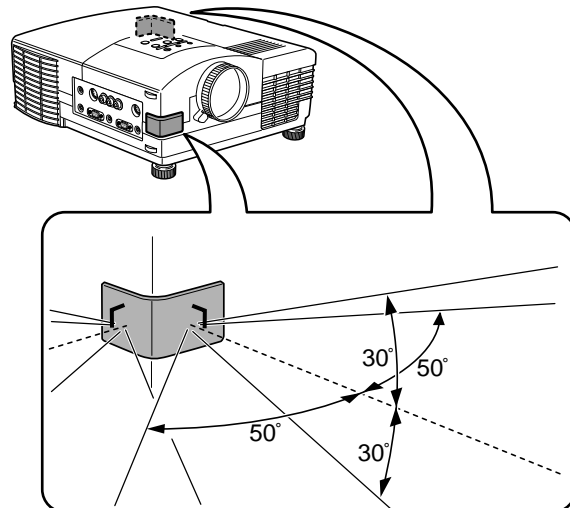

Parts and controls

For operational instructions, refer to the page indicated in brackets.

Front and side panel view

Control panel

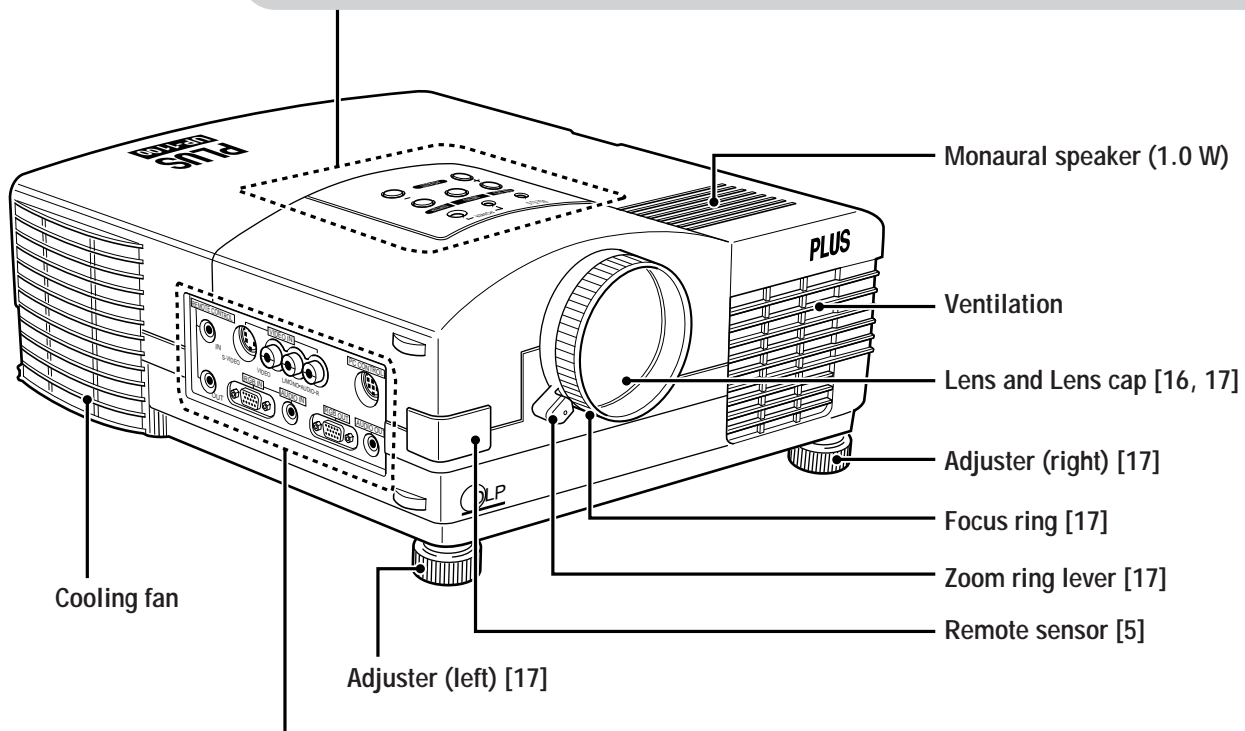
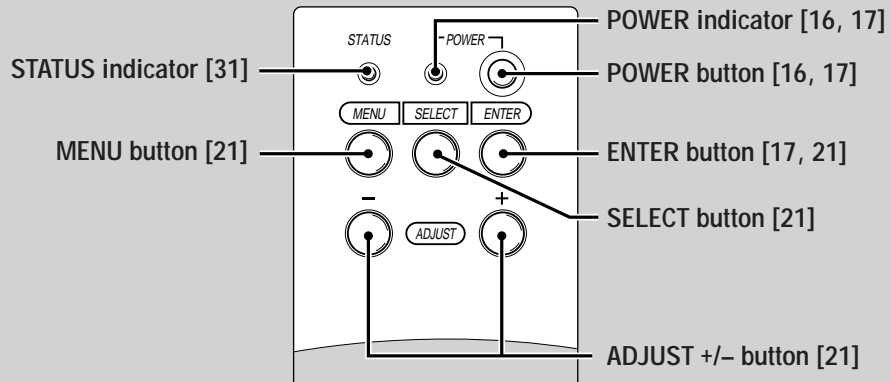

Terminal Panel

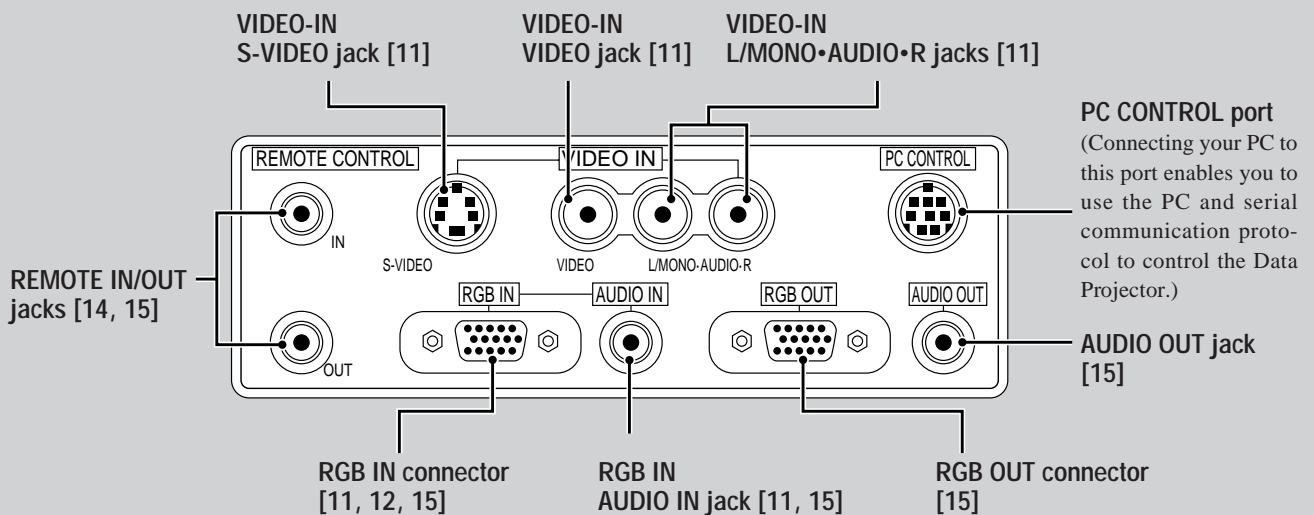

Rear and side panel view

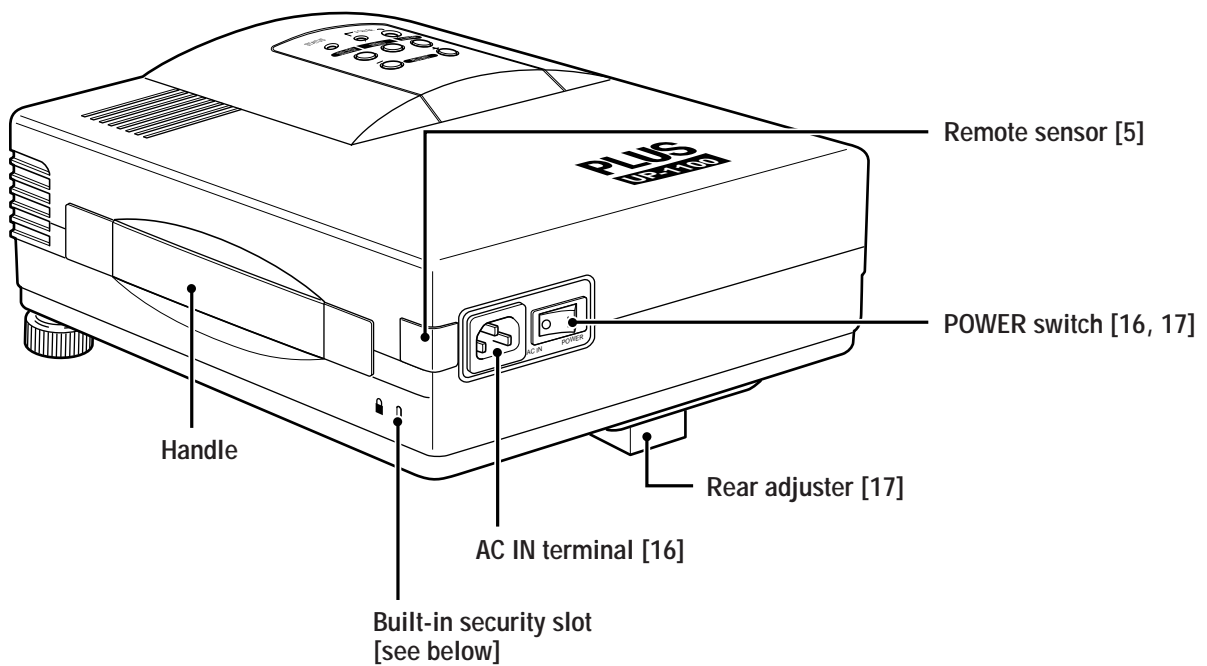

Built-in Security Slot



This security slot supports the MicroSaver® Security System. MicroSaver® is a registered trademark of Kensington Microware Inc. The logo  is trademarked and owned by Kensington Microware Inc.

Bottom

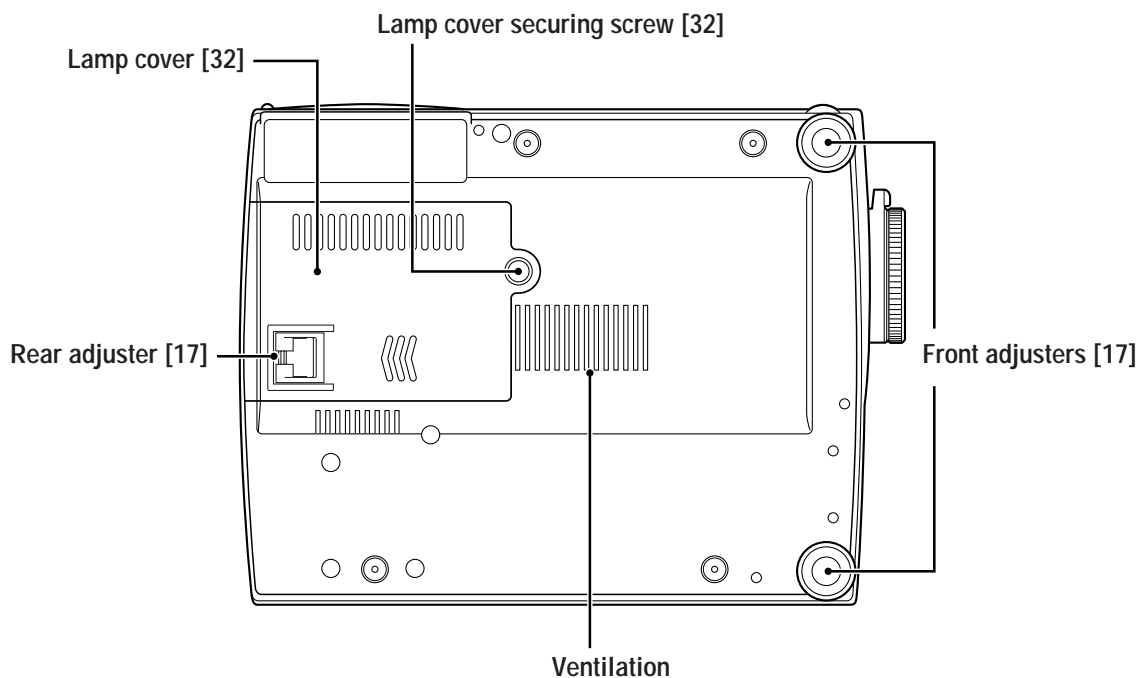

Remote control

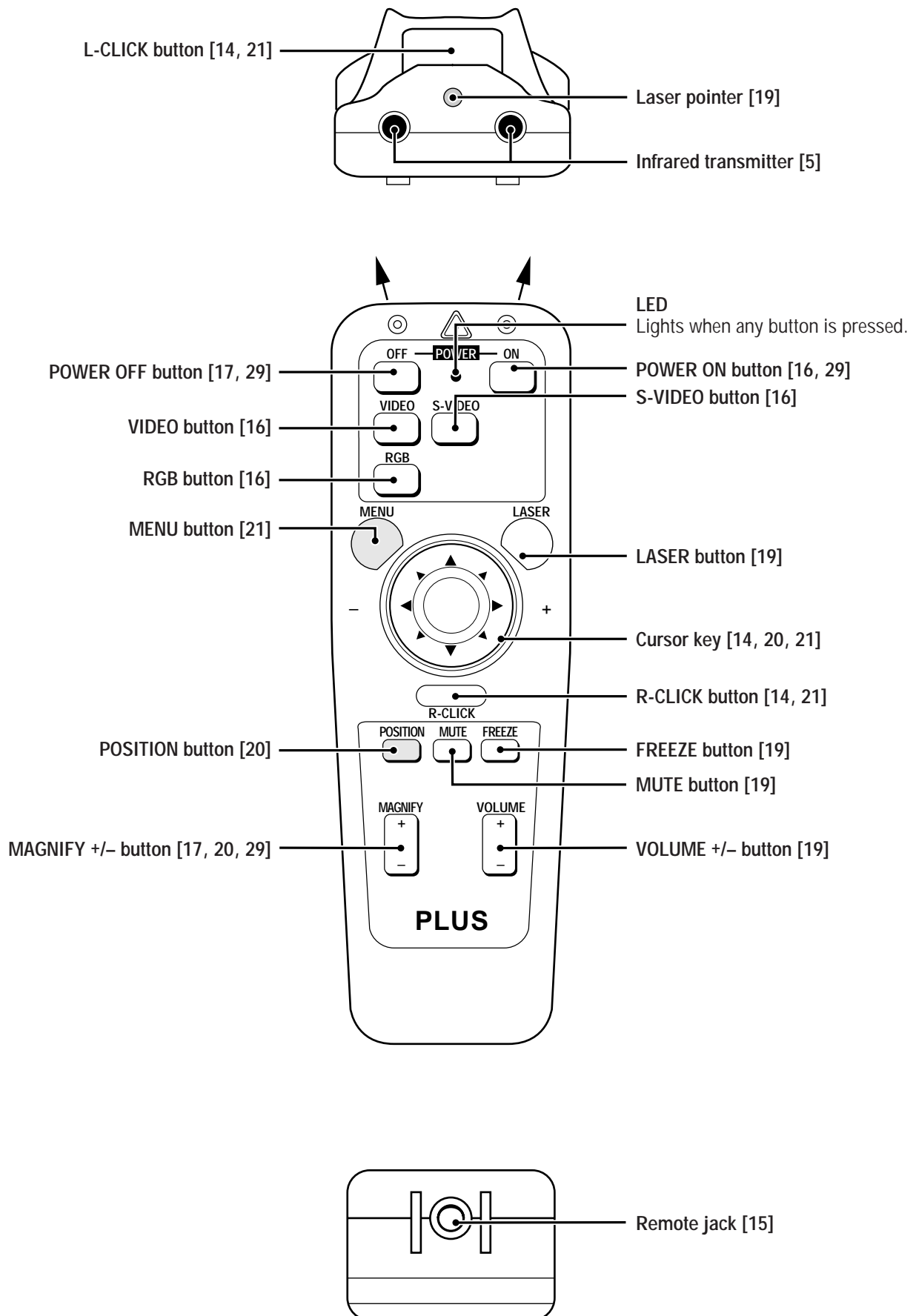

Installation

The distance from the unit lens to the screen determines to the size of the projected image, therefore, you need to consider the place where you set up the unit and screen before making connections. You also need to consider the screen size and height of the unit and screen as other important factors.

Tip

A non-glossy wall may be used as a substitute for a screen.

⚠ WARNING

• Carrying The Data Projector

Always carry your Data projector in the carrying case. Ensure that the power cord and any other cables connecting to video sources are disconnected before moving the projector. When moving the projector or when it is not in use, cover the lens with the lens cap.

- Only use your Data projector on a solid flat level surface. If the projector falls to the ground, you can be injured and the projector severely damage.
- Do not use the Data projector where temperatures vary greatly. The projector must be used at temperatures between 5°C (41°F) and 35°C (95°F).
- Do not expose the Data projector to moisture, dust, or smoke. This will harm the screen image.
- Ensure that you have adequate ventilation around your Data projector to allow heat dissipation. Do not cover the vents on the bottom or the side of the projector.

Positioning the unit

The projected image becomes larger as the distance between the unit and screen increases. The minimum image size is about 24 inches (0.61 m) diagonally at a distance of about 1.2 m (3 feet) and the maximum size is about 300 inches (7.6 m) at a distance of 12.0 m (39.37 feet) from the screen. Use the following information when you fix the position of the unit.

Projecting distance and image size

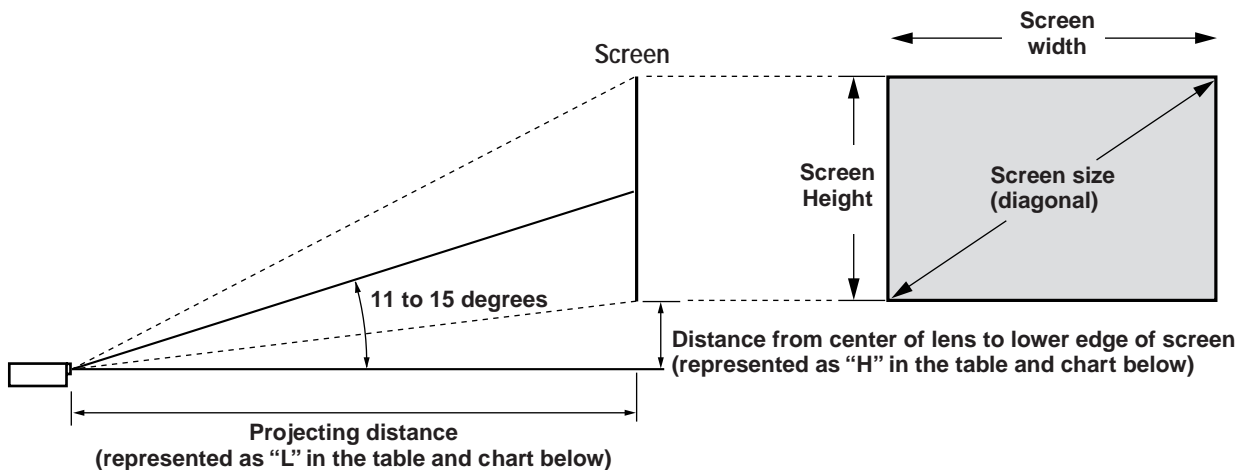

• Horizontal projection position — Lens centered left to right

• Vertical projection position

Screen size Inches	Projection distance (L) m		Dimension (H) mm
	Wide (W)	Telephoto (T)	Both W & T
24	—	1.2	70
40	1.6	2.1	122
60	2.4	3.1	176
80	3.2	4.2	238
100	4.0	5.3	291
200	8.1	10.6	599
300	12.3	—	891

Installation (continued)

• Projecting distance and image size

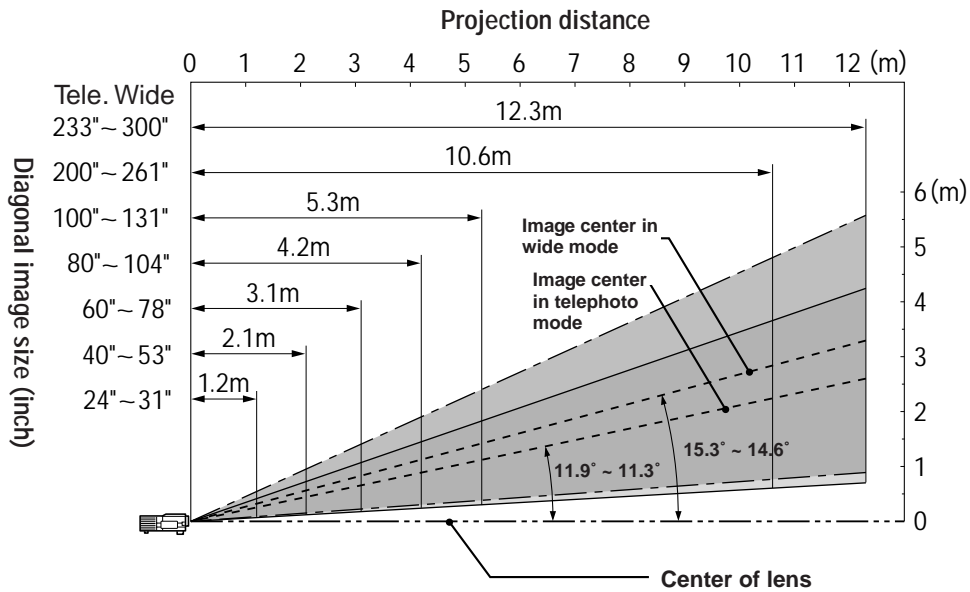

Using the ceiling mounting fixtures

When using the ceiling hanging fixtures, select "FRONT/CEILING" in "PROJECTION" in "SETTING MENU" (see pages 17 and 24).

Note

Installing the Data Projector on the ceiling must be performed by qualified PLUS service personnel. Contact your PLUS dealer for more information. Never attempt to install the Data Projector yourself.

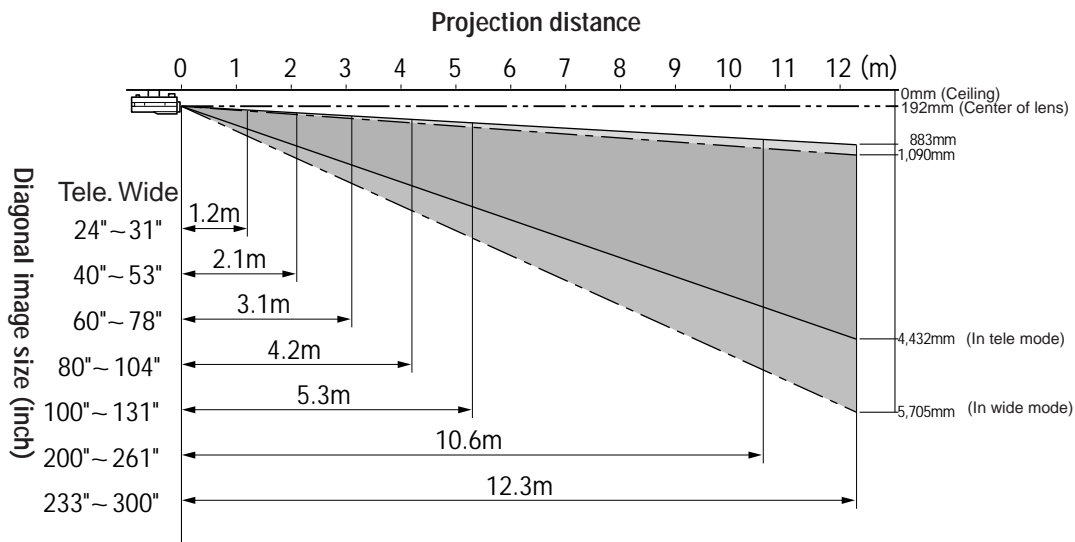

Connecting video equipment

You can connect a document camera, VCR, laser disc player, and DVD player, etc.

Connecting to the VIDEO IN VIDEO/S-VIDEO jacks

You can connect up to two pieces of video equipment to the VIDEO IN jacks following the illustration below. Two types of connections can be made. Connect either using the cables indicated in dotted lines or those in gray as shown in the drawing below.

- You can switch the input source (picture) to VIDEO or S-VIDEO even if you connect more than one piece of equipment. S-VIDEO connection provides more vivid color and higher resolution compared to VIDEO connection.
- You can output the sound of one component through the unit speaker even when two components are connected.

Before connecting

- Turn off the components that are to be connected.
- The unit and computer will be turned on in "Using the Data Projector" on page 16. Do not turn on either the computer or unit until you read this section.
- Please also refer to the manual of the video component to be connected.

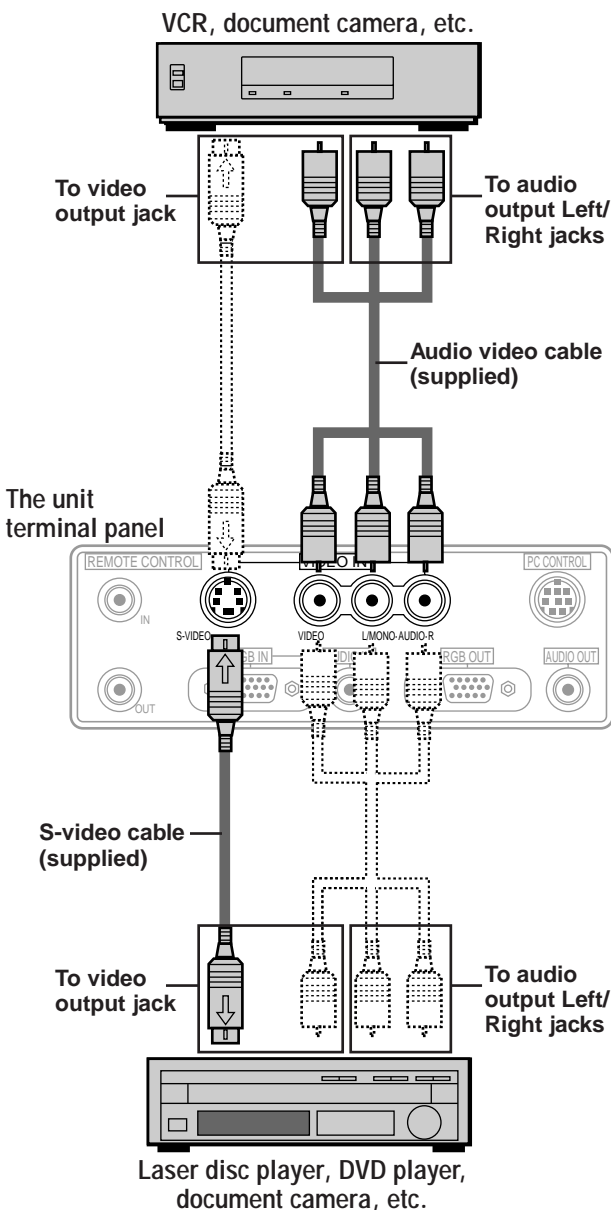

Connecting video equipment that has the component video signal (YCbCr) output jacks to the RGB IN connector

You can also connect the video component to the RGB IN connector, if the video component has the component video (YCbCr) signal jacks. This connection provides better picture quality than the connections on the left column.

- You can switch the input source to VIDEO, S-VIDEO, or RGB.
- The AUDIO IN jack is for equipment connected to the RGB IN connector.

Before connecting

- Turn off the components that are to be connected.
- The unit and computer will be turned on in "Using the Data Projector" on page 16. Do not turn on either the computer or unit until you read this section.
- Please also refer to the manual of the video component to be connected.

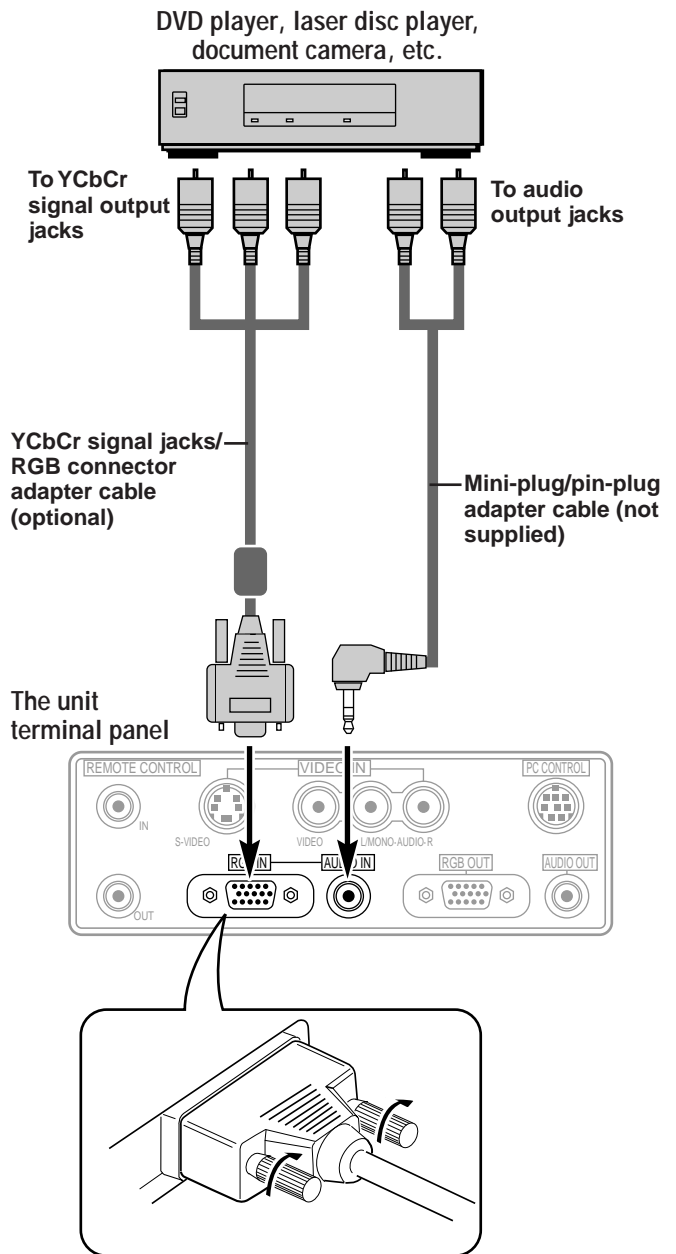

Plug the cable terminal into the RGB connector securely then tighten the screws.

Connecting a PC or Macintosh

Connecting a PC or Macintosh to the Data Projector will enable you to project your computer screen images for impressive presentations.

- The following display standards are supported:

VGA 640×480 for graphics	SuperVGA 800×600
VGA 640×350 for graphics	XGA 1024×768
VGA 720×350 for text	Macintosh at 640×480
VGA 640×400 for graphics	Macintosh at 832×624
VGA 720×400 for text	Macintosh at 1024×768

- A PC, Macintosh, or computer equipped with a XGA adapter or compatible graphics adapter can easily be connected.
- If your PC does not support XGA you will need to install a XGA graphics board. Consult your computer's owner's manual for your XGA configuration. If you need to install a new board, refer to the manual supplied with your new graphics board for installation instructions.

Notes

- Refer to the owner's manual supplied with your computer for more information about the video output requirements of the computer and any special identification or configuring required by the projector image and monitor.
- Some Macintosh PowerBooks may need to set the mirroring to off to output 1024×768 dot signals. Please consult your PowerBook manual or computer dealer for details.

Before connecting

- Turn off the computer that is to be connected.
- The unit and computer will be turned on in "Using the Data Projector" on page 16. Do not turn on either the computer or unit until you read this section.
- Please also refer to the manual of the computer to be connected.

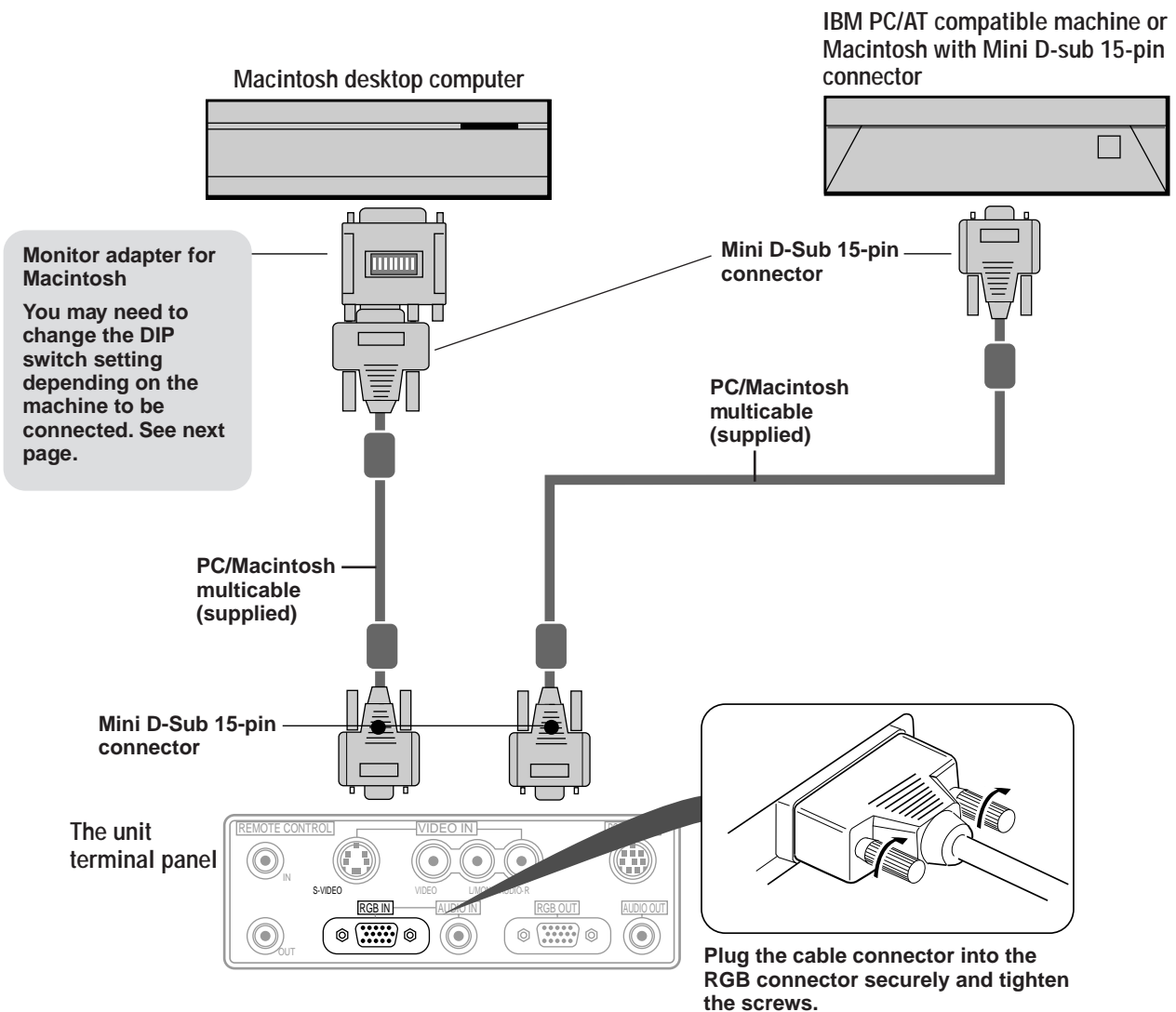

Note on the PowerBook connection

Depending on the model of your PowerBook, the additional Apple video cable adaptor may be required with the above connection.

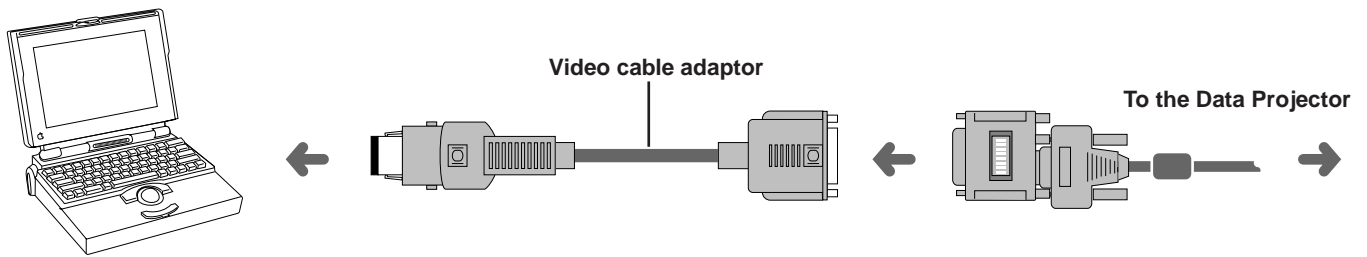

Modifying the DIP switch (for Macintosh) setting

Modify the DIP switch setting checking the DIP switch setting table below.

DIP switch setting (● = ON)

MONITOR	RESOLUTION	1	2	3	4	5	6
MULTIPLE SCAN 21		●	●				●
MULTIPLE SCAN 17		●	●			●	
MULTIPLE SCAN 16		●	●			●	●
VGA/SVGA				●	●		
21 COLOR	1152×870	●	●	●	●		
19 COLOR	1024×768		●	●			
16 COLOR	832×624		●		●		
13 COLOR	640×480	●	●				

Inch 13

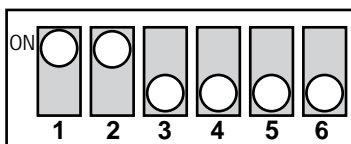

MULTIPLE SCAN 17

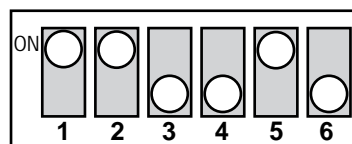

VGA/SVGA

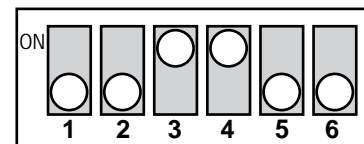

Using the remote control as a computer mouse - Wireless mouse function

The supplied remote mouse receiver enables you to operate your computer's mouse functions from the remote control. It is a great way to control your computer-generated presentations.

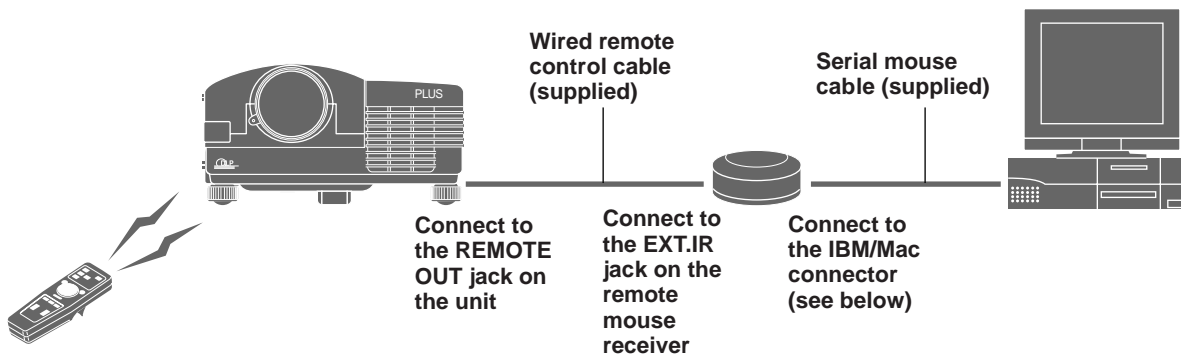

- The cursor key on the remote control operates the computer mouse functions.
- If a Windows computer is connected, the L-CLICK button on the remote control operates as the computer mouse left click button and the R-CLICK button as the computer mouse right click button.
- If the Macintosh computer is connected, the L-CLICK and R-CLICK buttons operate in the same way as the computer mouse click button.
- While the menu is displayed on the screen (see page 21), the cursor key, L-CLICK and R-CLICK buttons will operate to control the menu.

Before connecting

- Turn off the computer, then remove the current mouse.
- Connect the unit and remote mouse receiver with the supplied wired remote control cable as shown in the above illustration.
- The unit and computer will be turned on as described in "Using the Data Projector" on page 16. Do not turn on either the computer or unit until you read this section.
- Please also refer to the manual of the computer to be connected.

Connectors of the remote mouse receiver

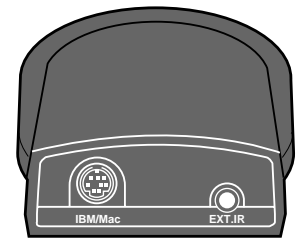

Connecting the remote mouse receiver to an IBM PC/AT computer

Connect the IBM/Mac connector on the remote mouse receiver and PC's mouse port with the supplied serial cable.

Remote mouse receiver

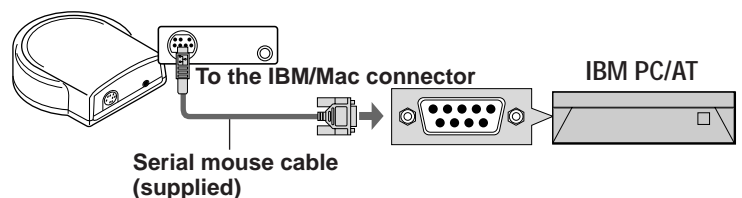

Connecting the remote mouse receiver to an IBM PS/2 or Macintosh computer

Connect the supplied serial cable to the IBM/Mac connector on the remote mouse receiver.

Connect the supplied mouse adapter to the other end of the serial cable and the computer mouse port. Note that two types of mouse adapters are supplied; one is for IBM PS/2 and the other is for Macintosh.

Remote mouse receiver

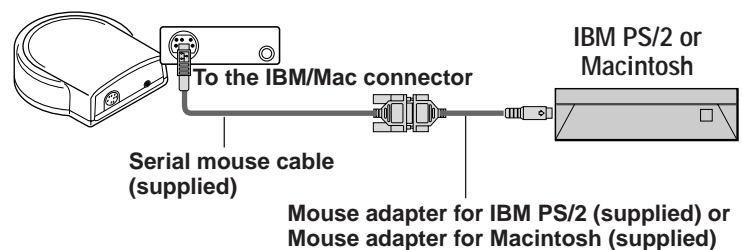

Another use of the remote mouse receiver

Connect the remote mouse receiver only to your computer following the above instructions. The remote control can be used to operate the computer mouse functions even if the remote mouse receiver is not connected to the Data Projector. Point the remote control to the remote mouse receiver while operating.



Additional connections

Outputting video/sound signals to another monitor/speaker via an amplifier

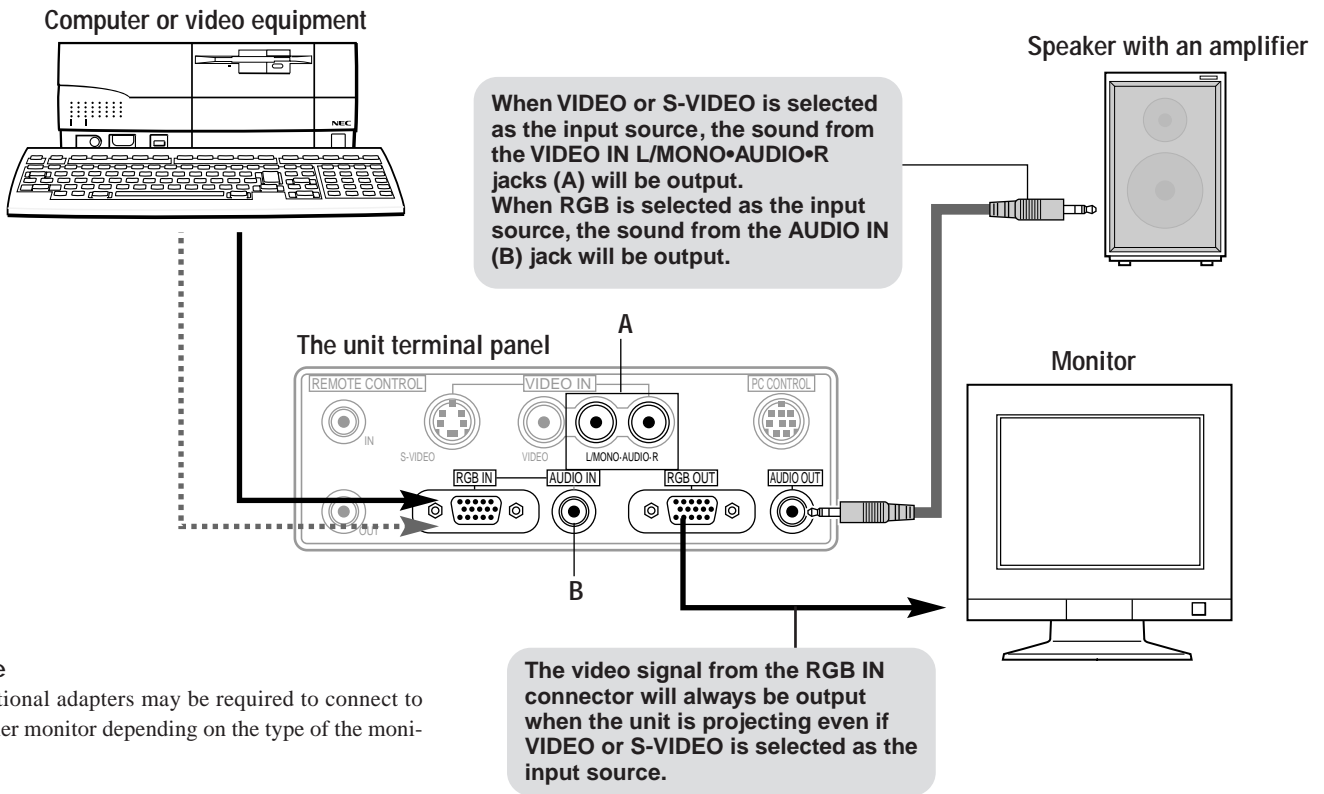

Connecting more than one Data Projector (UP-1100)/Using the wired remote control

Up to five interconnected Data Projectors can be controlled with the remote control.

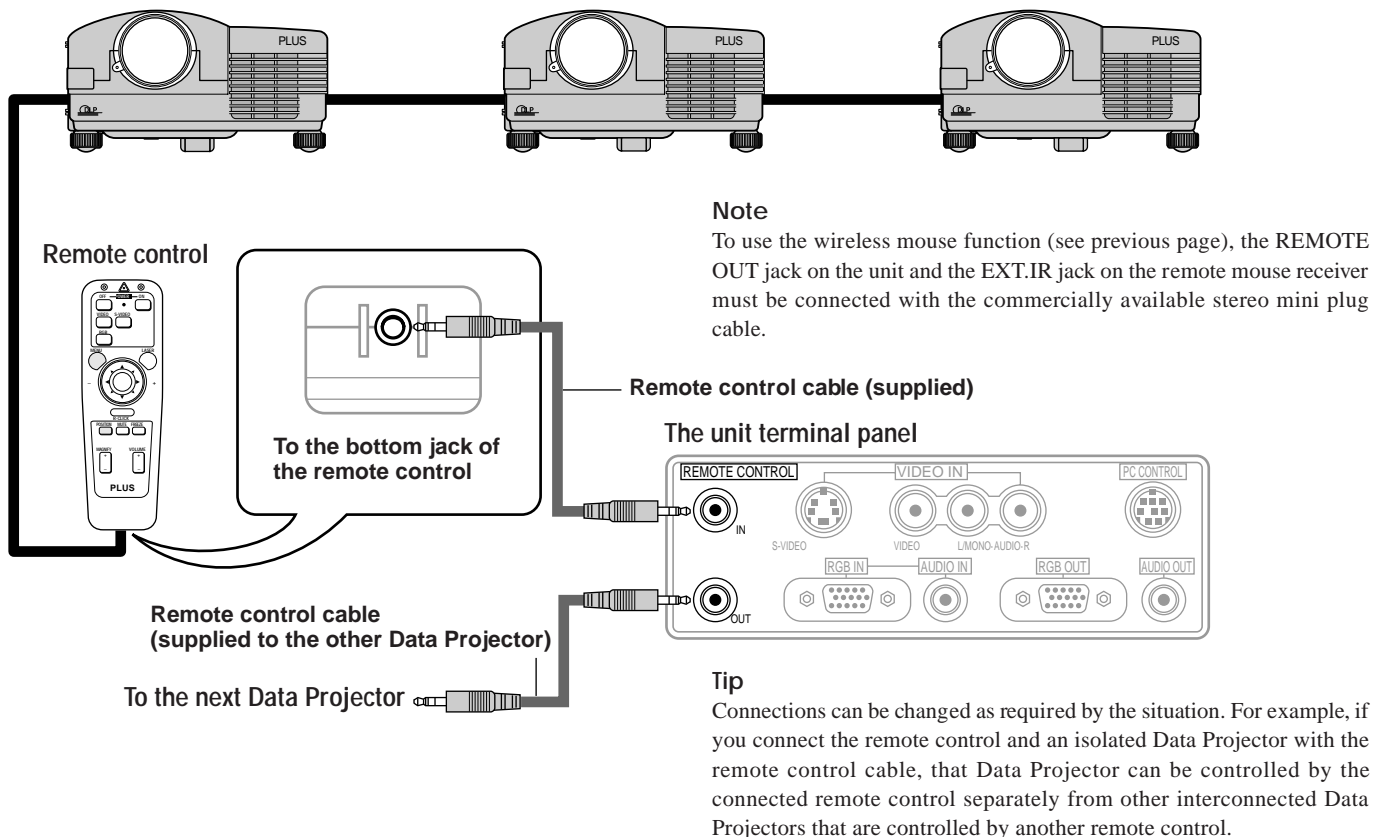

Using the Data Projector

Before starting

- Remove the lens cap from the lens. Please retain it because it must be replaced after use.
- Don't use the Data Projector in a bright room and don't expose the screen to direct sunlight or other strong light sources.

- 1 **Connect the supplied power cable to the unit, then to the wall outlet (the mains).**
 - 2 **Press the "I" side of the POWER switch (main power) on the back of the unit.**
The POWER indicator on top of the unit lights in amber.

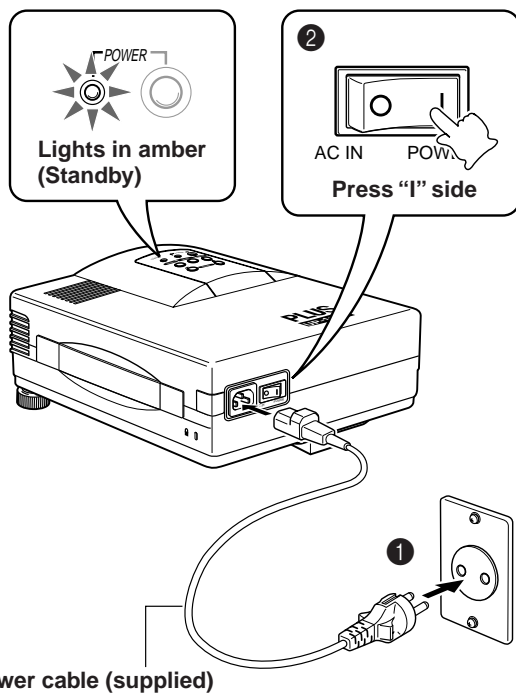

- 2 **Press the POWER ON button on the remote control or the POWER button on top of the unit to turn on the unit.**

The POWER indicator on top of the unit turns to green and start blinking.

It will take one minute for the unit to be ready to use. Wait until the indicator stops blinking and lights steadily in green.

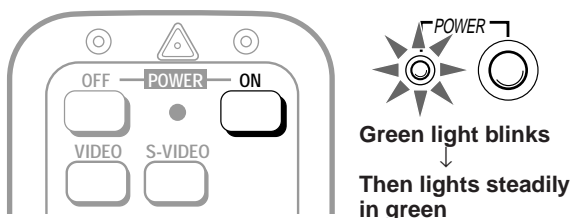

Note

While the POWER indicator is blinking, the unit doesn't turn off even if you press the POWER OFF button on the remote control or the POWER button on the unit.

Tip

If you set "AUTO START" to "ON" in the menu (see page 28), the unit will turn on automatically after setting the POWER switch to on in step 1.

- 3 **Turn on the connected source (computer, VCR, DVD player, etc.).**

If you use a video component, start playback for screen/image adjustment.

- 4 **Press either VIDEO, S-VIDEO, or RGB to select the input source.**

You can also select the input source with the menu operation (see page 21).

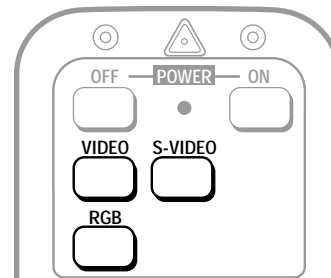

Notes

- If the blue, black, or focus pattern screen (the background type differs depending on the "BACKGROUND" setting. See page 24.) is projected, check the following:
 - Is the source properly connected to the unit?
 - Is the source component or computer turned on?
 - Are the video signals coming to the unit?
- The video resolution of the connected computer can be changed. See page 18.

- 5 **Adjust the position and height of the unit.**

Move the unit to the position where the projected image is horizontally centered to the screen.

- **When the projected image is offset horizontally**

Adjust the position of the unit so that the unit is square to the screen.

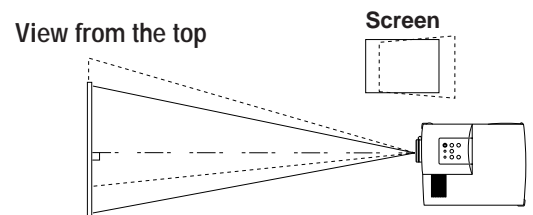

- **When the projected image is offset vertically**

Adjust the height balance of the unit with the adjusters.

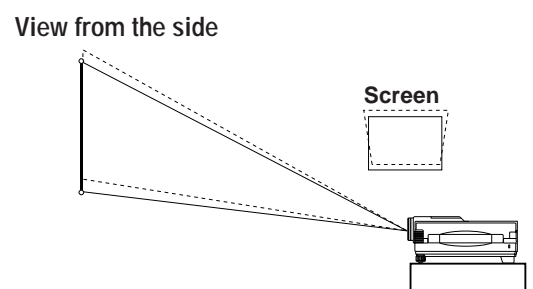

Using the adjusters to adjust the height balance

There are two front adjusters and a rear adjuster.

To lower the position of the screen, pull out the folded leg of the rear adjuster.

For the front adjusters, rotate each adjuster until the unit is vertically parallel to the screen.

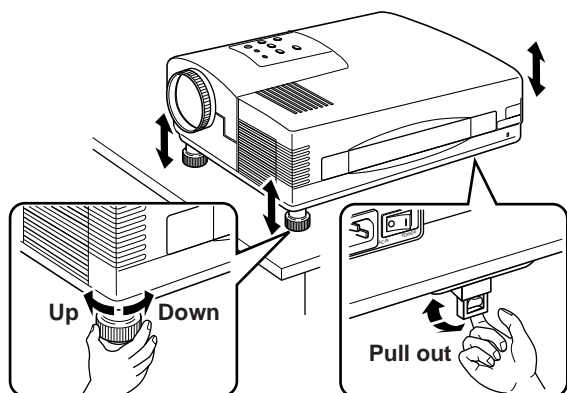

6 Adjust the image size with the zoom ring lever, then adjust the focus with the focus ring.

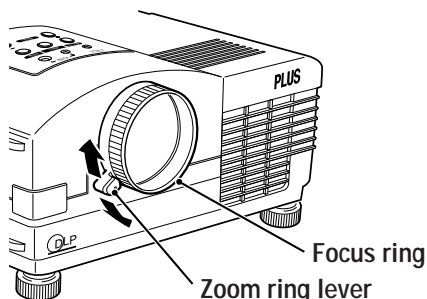

7 Change the unit setting to suit to the projecting method and selected source as described in step 4.

• **Select the type of projection**

If the projected image is horizontally reversed or upside down, change the projection type.

See page 24.

• **If the component video signal output jacks of the video component are connected to the RGB IN connector (see page 11), set "INPUT MODE" to "YCbCr" in the menu.**

This setting provides a better picture image. See page 24.

• **Adjust the projected image from the source connected to the RGB IN connector.**

The resolutions most suitable to the incoming signals will automatically be selected. However, if any vertical banding, noise, dot interference, or crosstalk appears on the screen, adjust "PICTURE ADJ," then "FINE PICTURE" using the menus. You can also adjust the horizontal and vertical position of the image. See pages 25 to 27.

8 Adjust the picture elements and select the picture type.

You can adjust the picture elements (see page 27), select the picture type according to the video contents (see page 28) and wide screen (see page 28).

9 Start using the Data Projector.

The following functions are available while using the Data Projector:

- **Adjusting the volume of the unit speaker (see pages 19 and 24),**
- **Using the laser pointer (see page 19),**
- **Turning off the image and muting the sound temporarily (see page 19),**
- **Freezing a moving picture (see page 19), and**
- **Enlarging the picture (see page 20).**

Note

If "POWER OFF" is set to "ON" (see page 28), the image will be turned off if the unit has been left unoperated for five minutes with an RGB input source.

If the image is suddenly turned off while projecting a computer image, the computer's screen saver or the unit's POWER OFF function may be activated.

After using the Data Projector

1 • **Operating with the remote control** **Press the POWER OFF button a little bit longer.**

• **Operating with the unit**

① **Press the POWER button.**

"POWER OFF/ENTER" appears on the screen.

② **Press ENTER.**

When you have turned off the unit, the POWER indicator will start blinking then turn to amber in one minute.

Never turn off the POWER switch (main power) while the POWER indicator is blinking.

To cancel turning off the unit when "POWER OFF/ENTER" is appearing on the screen

See "Canceling turning off the unit when 'POWER OFF/ENTER' is appearing on the screen" on page 29.

Please also read

"Activating the on-screen function" on page 29.

2 **If the POWER indicator is lit in amber, press the "O" side of the POWER switch (main power) on the back of the unit.**

The POWER indicator goes out.

Disconnect the power cord if it is not to be used for an extended period.

Changing computer's video resolutions

Depending on your computer's graphic capability, you may be able to select one of several resolutions. Generally a computer- either a PC or Macintosh- with 1 MB VRAM will run:

640 × 480 at 16.7 million colors (24 bit Truecolor)

800 × 600 at 65,000 colors.

1024 × 768 at 256 colors.

As the resolution increases, the number of colors you can run decreases. With 2 MB VRAM a computer will run:

640 × 480 at 16.7 million colors (24 bit Truecolor).

800 × 600 at 16.7 million colors (24 bit Truecolor).

1024 × 768 at 65,000 colors.

1280 × 1024 at 256 colors.

Windows 95

There are two methods you can use to change your resolution.

Method 1

- 1 Move your cursor to the background image and click.
- 2 In the "Properties" menu, select "Settings."
- 3 Change your resolution and click "OK."
- 4 You may be asked to reboot for the changes to take effect, or a message saying that "Windows is about to resize your display" may appear. You'll be asked if you want to keep your settings. Select "Yes."

Method 2

- 1 Click on your "My Computer" icon.
- 2 Open "Control Panel" and select "Display."
- 3 Change your resolution and click "OK." after the new resolution is selected.
- 4 You may be asked to reboot for the changes to take effect, or a message saying that "Windows is about to resize your display" may appear. You'll be asked if you want to keep your settings. Select "Yes."

Windows 3.1

- 1 Click on the "Main" icon and open "Control Panel."
- 2 Select "Change System Settings" and click on "Option."
- 3 Choose "Change Display Settings."
- 4 Select the resolution you want.
- 5 Choose the current or desired drive.
- 6 Restart Windows for the changes to take effect.

Macintosh

- 1 Under the Apple menu, select "Control Panels" and open "Monitors."
- 2 Click and open "Options."
- 3 Select your new resolution and click "OK."

Notebook computers and resolution standards

This Data Projector is designed to project industry standardized video such as VESA (Video Electronics Standards Association) or XGA (eXtended Graphics Array). Notebook computers do not use industry standards. They use whatever timing is necessary to match their local LCD display. The end result is typically not standard. By turning off your notebook's display, the timing parameters are a bit more like the real VESA or XGA signal.

Various functions while using the Data Projector

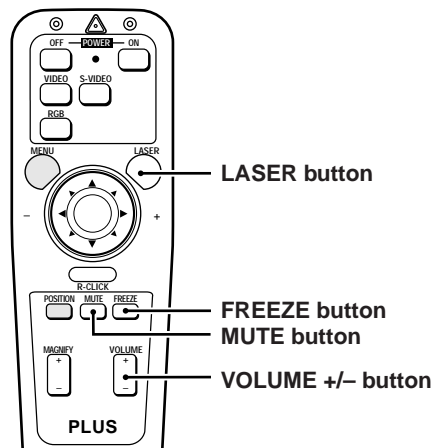

Adjusting the volume of the unit speaker

Press VOLUME + to increase the volume or – to decrease.

The volume can also be adjusted with the menu operation (see page 24).

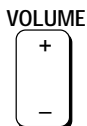

Turning off the image and muting the sound temporarily

Press MUTE.

The image will turn off and the sound will be muted at the same time. To restore the picture and sound, press the button again.



Using the laser pointer

You can highlight the desired point on the screen with the beamed red light.

Caution

Do not look into the laser pointer while it is on, nor point the laser beam at any other persons. This could result in serious eye damage or blindness.

Press LASER.

The red light will be beamed while pressing the button. The light goes out when you release the button.



Freezing a moving picture

You can capture the desired frame of the moving picture.

Press FREEZE.

A still image of the current frame will be displayed. To restore the present picture, press the button again.



Tip

The still picture can also be enlarged (see next page).

Various functions while using the Data Projector (continued)

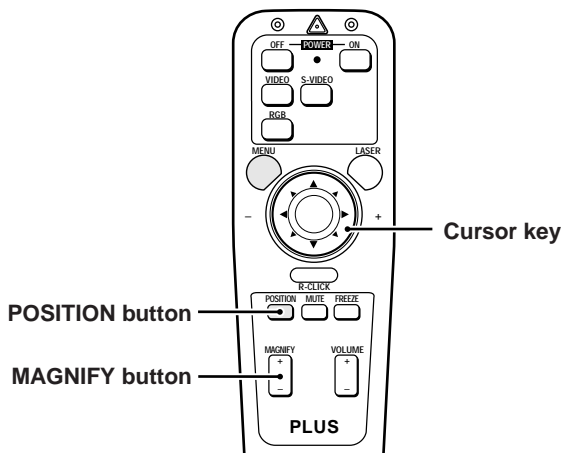

Enlarging the picture

You can enlarge the picture up to four times the normal size.

Press MAGNIFY +.

While the button is pressed the picture is enlarged until it becomes four times the normal size.

Release the button at the desired size.

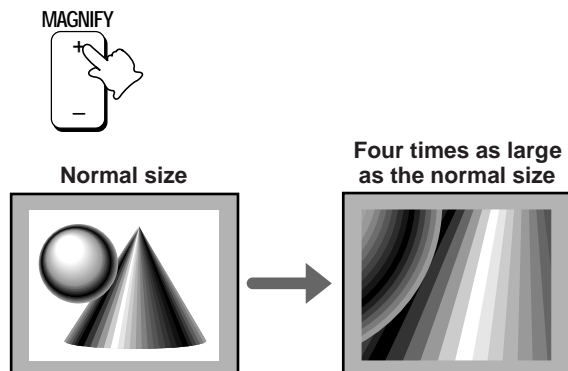

To reduce the size of the enlarged picture

Press MAGNIFY -.

While the button is pressed the picture is reduced until it becomes the normal size.

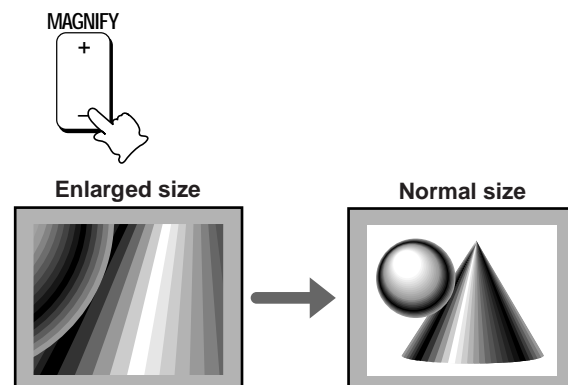

To move to the desired portion of the enlarged picture

1 Press POSITION.

The button lights in red. If you don't proceed to step 2 within ten seconds, the button goes off.

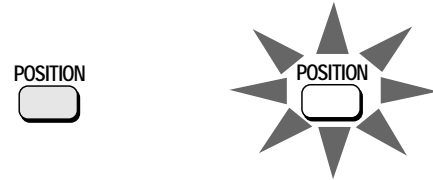

2 Press the desired portion of the cursor key while POSITION lights.

The moving directions are indicated by the eight triangle marks on the cursor key. The picture will move in the direction pointed by the mark where you are pressing.

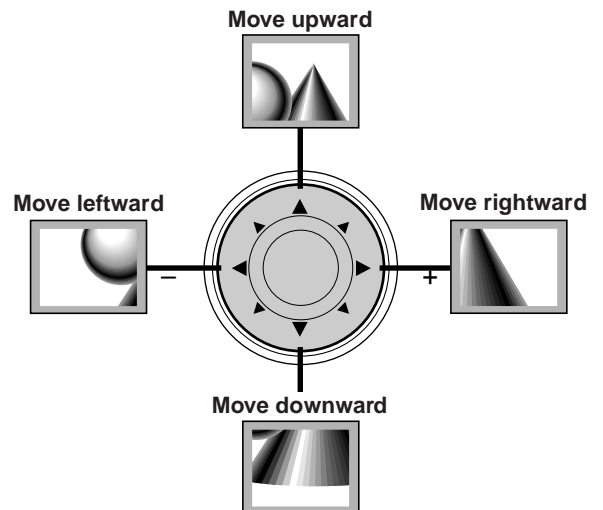

Note

The normal size of the picture cannot be moved because the whole image is fully displayed.

Basic operation (Selecting the input source)

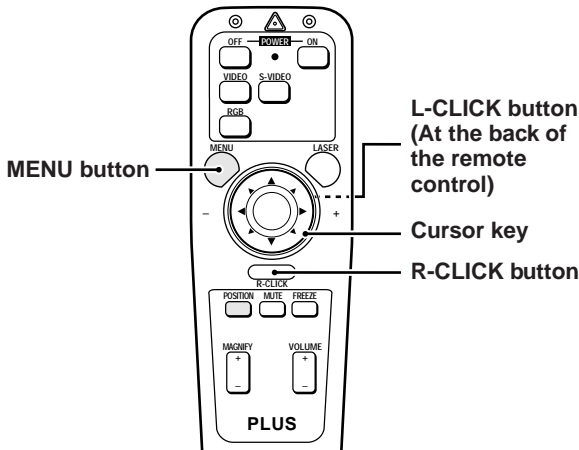

1 Press MENU.

The button lights in red and the main menu appears on the screen.

If you don't proceed to step 2 within ten seconds, the button goes off.

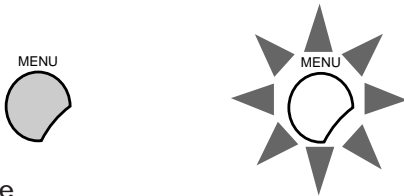

Note

The menu will not be displayed if the picture is enlarged even slightly. In such a case, reduce the picture size to normal before starting the menu operation.

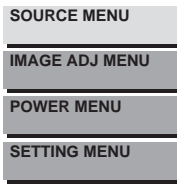

2 Press the cursor ▲ / ▼ key to select "SOURCE MENU."

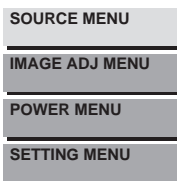
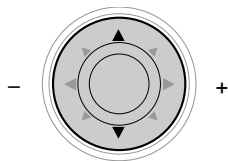

3 Press L-CLICK.

The source menu appears on the screen.

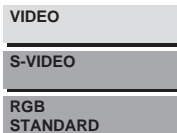

4 Press the cursor ▲ / ▼ key to select the desired input source.

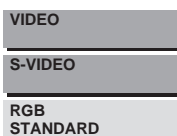
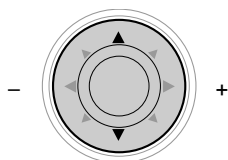

5 Press L-CLICK.

The source you've selected in step 4 will be confirmed, then the picture from the selected source will be projected on the screen.



6 Press R-CLICK to turn off the menu display.

Whenever you wish to turn off the menu display, press R-CLICK button.

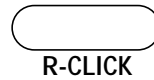

Operating with the unit

The menu operation is explained using the remote control, however, it can also be controlled with the unit operation buttons.

To operate with the unit, refer to the comparison table below.

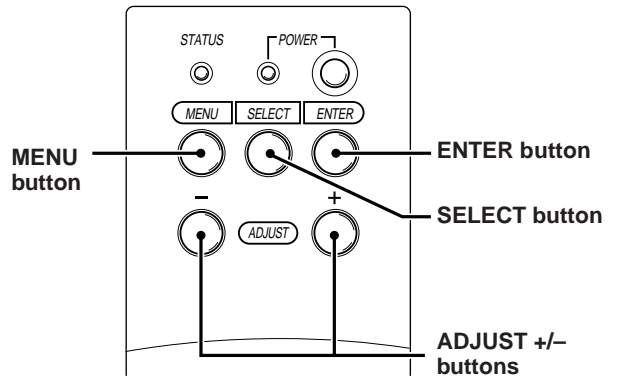

The remote control and unit button comparison table

Remote control buttons

MENU

The main menu appears on the screen when you press this button.

To turn off any menu, press **R-CLICK**.

Cursor ▲ / ▼ key

Press either key to select the menu item.

L-CLICK

Press this button whenever confirming operation is required.

Cursor + / - key

Press either key to choose the setting or value of the selected menu item.

Unit operation buttons

MENU

The main menu appears on the screen when you press this button.

To turn off any menu, press **R-CLICK** on the remote control.

SELECT

Each press change the menu item to the next.

ENTER

Press this button whenever confirming operation is required.

ADJUST + / -

Press either button to choose the setting or value of the selected menu item.

Menu structure

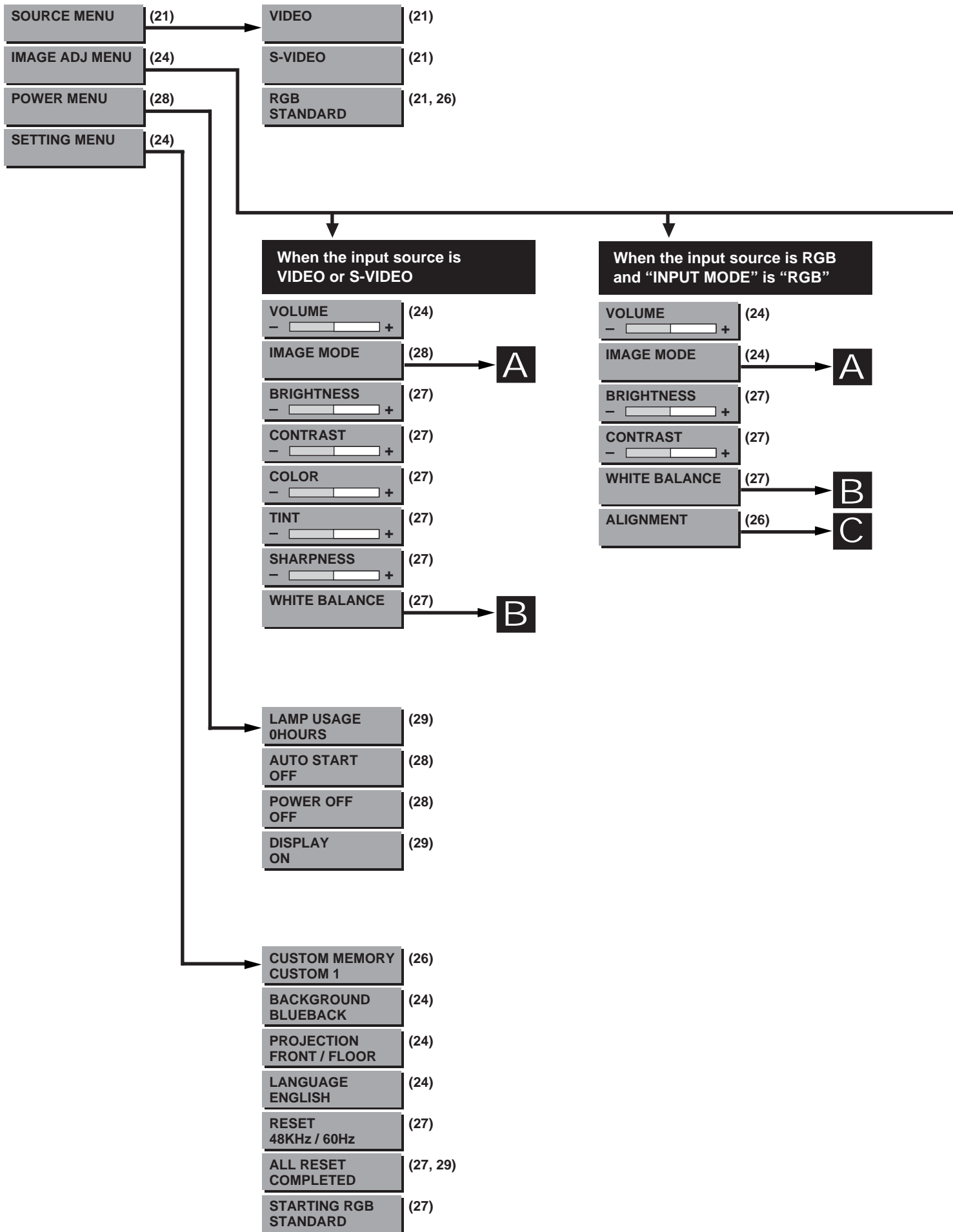

When the input source is RGB and "INPUT MODE" is "YCbCr"

VOLUME (24)
- [] +

IMAGE MODE (24) → **A**

BRIGHTNESS (27)
- [] +

CONTRAST (27)
- [] +

COLOR (27)
- [] +

TINT (27)
- [] +

WHITE BALANCE (27) → **B**

ALIGNMENT (26) → **C**

A

When the input source is VIDEO or S-VIDEO

GAMMA NORMAL (28)

INPUT MODE GRAPHICS (28)

DISPLAY MODE NORMAL (28)

WHITE PICTURE NORMAL (28)

When the input source is RGB

GAMMA NORMAL (28)

INPUT MODE RGB (24)

DISPLAY MODE NORMAL (28)

WHITE PICTURE NORMAL (28)

B

- When the input source is VIDEO or S-VIDEO
- When the input source is RGB and "INPUT MODE" is "RGB"

BRIGHTNESS R (27)
- [] +

BRIGHTNESS G (27)
- [] +

BRIGHTNESS B (27)
- [] +

CONTRAST R (27)
- [] +

CONTRAST G (27)
- [] +

CONTRAST B (27)
- [] +

When the input source is RGB and "INPUT MODE" is "YCbCr"

COLOR Cr (27)
- [] +

COLOR Cb (27)
- [] +

HUE Cr (27)
- [] +

HUE Cb (27)
- [] +

C

H POSITION (26)
- [] +

V POSITION (26)
- [] +

AUTO PICTURE OFF (26)

* PICTURE ADJ 1160 (26)

* FINE PICTURE 64 (26)

* Displayed only when "AUTO PICTURE" is "OFF."

Selecting the projection type

This reorients your image for your type of projection.

- 1 Press MENU to display the main menu.
- 2 Press the cursor ▲/▼ key to select “SETTING MENU.”
- 3 Press L-CLICK to display the SETTING MENU.
- 4 Press the cursor ▲/▼ key to select “PROJECTION.”
- 5 Press the cursor + / - key to select the projection type which suits the Data Projector setup conditions.

The following four projection types can be selected:

- FRONT FLOOR (Normal),
 - REAR CEILING (Upside down and horizontally reversed),
 - REAR FLOOR (Horizontally reversed), or
 - FRONT CEILING (Upside down).
- 6 Press L-CLICK.

Selecting a display language

- 1 Press MENU to display the main menu.
- 2 Press the cursor ▲/▼ key to select “SETTING MENU.”
- 3 Press L-CLICK to display the SETTING MENU.
- 4 Press the cursor ▲/▼ key to select “LANGUAGE,” then press the cursor + / - to select one of the following languages:
 - ENGLISH (English),
 - DEUTSCH (German),
 - FRANÇAIS (French),
 - ITALIANO (Italiano),
 - ESPAÑOL (Spanish),
 - SVENSKA (Swedish), or
 - 日本語 (Japanese).
- 5 Press L-CLICK.

Adjusting the volume

The volume can also be adjusted with VOLUME +/- on the remote control (see page 19).

- 1 Press MENU to display the main menu.
- 2 Press the cursor ▲/▼ key to select “IMAGE ADJ MENU.”
- 3 Press L-CLICK to display the IMAGE ADJ MENU.
- 4 Press the cursor ▲/▼ key to select “VOLUME,” then press the cursor + / - key to adjust the volume.

Selecting the background

- 1 Carry out steps 1 to 3 in “Selecting the projection type” on the left column.
- 2 Press the cursor ▲/▼ key to select “BACKGROUND.”
- 3 Press the cursor + / - key to select one of the following background types:
 - BLUEBACK,
 - BLACKBACK, or
 - FOCUS PATTERN.
- 4 Press L-CLICK.

Setting “INPUT MODE” to “YCbCr”

When you have connected the component video (YCbCr) signal output jacks of the video component to the RGB IN connector on the unit (see page 11), set “IMAGE MODE” to “YCbCr” to obtain better picture quality.

- 1 Select the input source RGB (see page 16 or 21).
- 2 Press MENU to display the main menu.
- 3 Press the cursor ▲/▼ key to select “IMAGE ADJ MENU.”
- 4 Press L-CLICK to display the IMAGE ADJ MENU.
- 5 Press the cursor ▲/▼ key to select “IMAGE MODE.”
- 6 Press L-CLICK to display the IMAGE MODE menu.
- 7 Press the cursor ▲/▼ key to select “INPUT MODE.”
- 8 Press the cursor + / - key to select “YCbCr.”
Each press changes the setting to “RGB” or “YCbCr.”
- 9 Press L-CLICK.

The change of settings will be confirmed.

When you display the IMAGE MODE menu next, the following IMAGE MODE menu for YCbCr will be displayed.

IMAGE ADJ MENU for YCbCr (video component)



IMAGE ADJ MENU for RGB (computer)

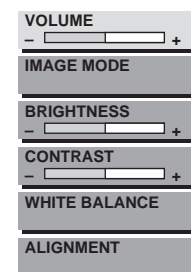

When you have disconnected the present video component from the RGB IN connector and reconnected a computer

Set “INPUT MODE” to “RGB” in step 8 above.

Adjusting the image from the source connected to the RGB IN connector

The Data Projector selects the most suitable resolutions as shown in the “Timing Chart” below according to the incoming signals from the RGB IN connector (When “RGB” is set to “STANDARD.” See page 26). However, you may need manual adjustment depending on the computer or video component connected to the RGB IN connector (see pages 11 and 12). If you have any of vertical banding, noise, dot interference, or crosstalk on the projected picture, adjust clock frequency with “PICTURE ADJ” then clock phase with “FINE PICTURE” (see next page). You can also adjust the horizontal and vertical position of the image (see page 26).

Timing Chart

Signal	Resolution	V. Sync. (Hz)	H. Sync. (kHz)	Dot Clock (MHz)	Signal	Resolution	V. Sync. (Hz)	H. Sync. (kHz)	Dot Clock (MHz)
1. NTSC	640 × 480	59.94	15.734	-	30. Mac	1024 × 768	59.95	48.8	64
2. CGA	640 × 200	61.05	15.873	14.22	31. Silicon	1024 × 768	60.4	49.7	70
3. EGA	640 × 350	59.89	21.98	16.41	32. VESA	1024 × 768	85	68.677	94.5
4. NEC	640 × 400	56.43	24.827	21.05	33. VESA	1024 × 768	70.07	56.476	75
5. PGA	640 × 400	60.24	30.3	25	34. XGA2	1024 × 768	72.03	58.131	79.012
6. IDC3000	640 × 480	59.94	31.468	-	35. VESA	1024 × 768	75.03	60.023	78.75
7. VESA	640 × 350	70.09	31.469	25.18	36. Mac19	1024 × 768	74.93	60.241	80
8. VESA	640 × 400	70.09	31.469	25.18	37. SUN	1024 × 1024	61.4	65.267	92.94
9. VESA	640 × 480	70.09	31.469	25.18	38. NEC	1120 × 750	80	32.84	47.82 *
10. Mac13	640 × 480	66.67	35.002	30.24	39. NEC	1120 × 750	60.06	50.025	60.06 *
11. VESA	640 × 350	85.08	37.861	31.5	40. VESA	1152 × 864	75	67.5	108 *
12. VESA	640 × 400	85.08	37.861	31.5	41. SUN	1152 × 900	65.95	61.796	92.94 *
13. VESA	640 × 480	75	37.5	31.5	42. Mac21	1152 × 870	75.6	68.681	100 *
14. VESA	640 × 480	72.81	37.861	31.5	43. Silicon	1152 × 900	76.05	71.736	105.6 *
15. IBM XGA2	640 × 480	75	39.375	31.49	44. VESA	1280 × 960	60	60	108 *
16. VESA	640 × 480	85.01	43.269	36	45. VESA	1280 × 960	85	85.938	148.5 *
17. VESA	720 × 400	85.04	37.927	40	46. Silicon	1280 × 1024	60	63.9	107.35 *
18. XGA2	720 × 350	87.85	39.444	35.5	47. Mac	1280 × 1024	60.38	64.31	107 *
19. IBM XGA2	720 × 400	87.7	39.375	35.5	48. VESA	1280 × 1024	60.02	64.286	108 *
20. PAL	768 × 576	50	15.625	-	49. NEC	1280 × 1024	59.93	64.603	107.5 *
21. SECAM	768 × 576	50	15.625	-	50. VESA	1280 × 1024	69.85	74.882	126.996 *
22. IDC300G	768 × 576	50	31.746	-	51. Mac	1280 × 1024	69.89	74.882	118.5 *
23. VESA	800 × 600	56.25	35.156	36	52. NEC	1280 × 1024	71.2	75.12	125 *
24. VESA	800 × 600	60.32	37.879	40	53. VESA	1280 × 1024	71.99	76.75	129.54 *
25. VESA	800 × 600	75	46.875	49.5	54. HP	1280 × 1024	72.01	78.125	135 *
26. VESA/XGA2	800 × 600	72.19	48.077	50	55. VESA	1280 × 1024	74.12	78.855	135 *
27. VESA	800 × 600	85.06	53.674	56.25	56. VESA	1280 × 1024	75.025	79.976	135 *
28. Mac16	832 × 624	74.55	49.725	57.283	57. SUN	1280 × 1024	76.11	81.13	135 *
29. VESA	1024 × 768	60	48.363	65	58. VESA	1280 × 1024	85.024	91.146	157.5 *

*AccuBlend™

The resolution of the Data Projector is 1024 × 768. Other resolution images (e.g. 1280 × 1024) are compressed into 1024 × 768. In such a case, projected letters and lines on the screen might appear unevenly.

Adjusting the clock frequency (PICTURE ADJ) and clock phase (FINE PICTURE) manually

When "AUTO PICTURE" is set to "ON," the clock frequency and clock phase will be adjusted automatically. However, if you need any manual adjustment for these two items, you first need to set "AUTO PICTURE" to "OFF" as indicated in the following steps.

Adjust the clock frequency to eliminate any vertical banding, then clock phase to reduce any video noise, dot interference, or cross talk. (When clock phase is not matched evidently, the image appears to be shimmering.)

1 Setting the input source to "RGB"

Select the input source RGB (see page 16 or 21).

2 Setting "AUTO PICTURE" to "OFF" for manual adjustment

- 1 Press MENU to display the main menu.
- 2 Press the cursor ▲/▼ key to select "IMAGE ADJ MENU."
- 3 Press L-CLICK to display the IMAGE ADJ MENU.
- 4 Press the cursor ▲/▼ key to select "ALIGNMENT."
- 5 Press L-CLICK to display the ALIGNMENT menu.
- 6 Press the cursor ▲/▼ key to select "AUTO PICTURE."
- 7 Press the cursor – key to select "OFF," then press L-CLICK.

"PICTURE ADJ" and "FINE PICTURE" appear below "AUTO PICTURE."

3 Adjusting the clock frequency

- 1 Press the cursor ▲/▼ key to select "PICTURE ADJ."
- 2 Press the cursor – key until the vertical banding disappears.
Press + to increase the frequency and – to decrease.

4 Adjusting the clock phase

- 1 Press the cursor ▲/▼ key to select "FINE PICTURE."
- 2 Press the cursor +/- key until the video noise, dot interference, and cross talk are reduced.

Press + to increase the number and – to decrease the number.

If the image (and the menu) has disappeared while setting the clock frequency or clock phase

Carry out the following steps.

- 1 Turn off the source connected to the RGB IN connector.
The incoming signals from the source go down and blue, black, or focus pattern screen (the background type differs depending on the "BACKGROUND" setting. See page 24.) will be displayed.
- 2 Carry out "Resetting the present settings to factory settings" on the next page.
- 3 Turn on the source, then carry out "Adjusting the clock frequency and clock phase manually" from the beginning.

When you have connected another computer or video component

Set "AUTO PICTURE" to "ON" by pressing the cursor + key in step 2-7 above.

Adjusting the horizontal (H POSITION) and vertical (V POSITION) position of the image

- 1 Carry out steps 1 to 2-5 on the left column.
- 2 Press the cursor ▲/▼ key to select "H POSITION."
- 3 Press the cursor +/- key to adjust the horizontal position.
Press + to move the image right and – to move it left.
- 4 Press the cursor ▲/▼ key to select "V POSITION."
- 5 Press the cursor +/- key to adjust the vertical position.
Press + to move the image up and – to move it down.

Storing the most recent "PICTURE ADJ," "FINE PICTURE," "H POSITION," and "V POSITION" settings

You can store the above present settings in the memory, CUSTOM 1 to 5.

- 1 Select the input source RGB (see page 16 or 21).
- 2 Press MENU to display the main menu.
- 3 Press the cursor ▲/▼ key to select "SETTING MENU."
- 4 Press L-CLICK to display the SETTING MENU.
- 5 Press the cursor ▲/▼ key to select "CUSTOM MEMORY."
- 6 Press the cursor +/- key to select the memory CUSTOM 1 to 5.
- 7 Press L-CLICK to store the settings.
The menu will be turned off after storing the settings.

Retrieving data from the custom memory/Setting "RGB" to "STANDARD"

The stored settings in the CUSTOM 1 to 5 memory can be retrieved according to the following steps.

- 1 Select "RGB" as the input source (see page 21).
- 2 Press the cursor +/- key to select the memory CUSTOM 1 to 5 or "STANDARD."
If you select "STANDARD," the unit will select the most suitable resolution automatically.
- 3 Press L-CLICK to retrieve the settings.

If the image (and the menu) has disappeared because the wrong custom memory is selected

Carry out the following steps.

- 1 Turn off the source connected to the RGB IN connector.
The incoming signals from the source go down and blue, black, or focus pattern screen (the background type differs depending on the "BACKGROUND" setting. See page 24.) will be displayed.
- 2 Select the right custom memory starting "Retrieving data from the custom memory" from the beginning.

Adjusting the picture elements

Selecting the starting mode for the next use of the unit

Set "STARTING RGB" to "LATEST" to use the most recent settings (RGB STANDARD or CUSTOM 1 to 5) when you turn on the unit next. If you set "STARTING RGB" to "STANDARD," the unit will select the most suitable resolution every time you turn on the unit.

- 1 Carry out steps 1 to 4 in "Storing the most recent settings" on the previous page.
- 2 Press the cursor ▲/▼ key to select "STARTING RGB."
- 3 Press the cursor +/- key to select either "LATEST" or "STANDARD."
- 4 Press L-CLICK.

The change of settings will be confirmed.

Resetting the present settings to factory settings

To reset the changed "PICTURE ADJ," "FINE PICTURE," "H POSITION," and "V POSITION" to the factory settings, carry out the following steps.

- 1 Carry out steps 1 to 4 in "Storing the most recent settings" on the previous page.
- 2 Press the cursor ▲/▼ key to select "RESET."
The horizontal frequency of the present incoming signal appears under the title "RESET."
- 3 Press and hold down the cursor + key for more than three seconds until "COMPLETE" appears instead of the horizontal frequency.

Resetting the present settings and all the custom memories to factory settings

Note

If you carry out this procedure, not only the custom memories but also all the menu items except for "LAMP USAGE," and "LANGUAGE" will be reset.

- 1 Carry out steps 1 to 4 in "Storing the most recent settings" on the previous page.
- 2 Press the cursor ▲/▼ key to select "ALL RESET."
- 3 Press and hold down the cursor + key for more than three seconds until "COMPLETE" appears under the title "ALL RESET."

The picture elements such as brightness, contrast, white balance, and so on can be adjusted individually for each input source. The adjustable items vary depending on the input source and "INPUT MODE" setting (see page 24).

(The elements marked with "•" are adjustable.)	Input source		
	VIDEO S-VIDEO	RGB	
		INPUT MODE (See page 24.)	
	RGB	YCbCr	
BRIGHTNESS	•	•	•
CONTRAST	•	•	•
COLOR	•	–	•
TINT	•	–	•
SHARPNESS	•	–	–
WHITE BALANCE	•	•	•

- 1 Select the input source (see page 16 or 21).
- 2 Press MENU to display the main menu.
- 3 Press the cursor ▲/▼ key to select "IMAGE ADJ MENU."
- 4 Press L-CLICK to display the IMAGE ADJ MENU.
- 5 Press the cursor ▲/▼ key to select "BRIGHTNESS," then press the cursor +/- key to adjust the brightness.
- 6 Press the cursor ▲/▼ key to select "CONTRAST," then press the cursor +/- key to adjust the contrast.
- 7 Press the cursor ▲/▼ key to select "COLOR," then press the cursor +/- key to adjust the color.

If the input source is RGB and "INPUT MODE" is "RGB," skip this step and go to step 10.

- 8 Press the cursor ▲/▼ key to select "TINT," then press the cursor +/- key to adjust the tint.

Note

The tint control doesn't operate with a PAL or SECAM source.

- 9 Press the cursor ▲/▼ key to select "SHARPNESS," then press the cursor +/- key to adjust the sharpness.

If the input source is RGB, skip this step and go to the next step.

- 10 Press the cursor ▲/▼ key to select "WHITE BALANCE," then press L-CLICK.

The WHITE BALANCE menu appears.

- 11 Press the cursor ▲/▼ key to select each item in the WHITE BALANCE menu, then press the cursor +/- key to adjust the item for the white color balance.

Selecting the picture type

The picture types can be selected individually for each input source according to the video content and your preferences.

- 1 Select the input source (see page 16 or 21).
- 2 Press MENU to display the main menu.
- 3 Press the cursor ▲/▼ key to select "IMAGE ADJ MENU."
- 4 Press L-CLICK to display the IMAGE ADJ MENU.
- 5 Press the cursor ▲/▼ key to select "IMAGE MODE."
- 6 Press L-CLICK to display the IMAGE MODE menu.
- 7 Press the cursor ▲/▼ key to select "GAMMA," then press the cursor +/- key to select the gamma mode.

The following three types of gamma modes can be selected according to your preferences:

- NORMAL,
- NATURAL 1, or
- NATURAL 2.

- 8 Press L-CLICK.
- 9 Press the cursor ▲/▼ key to select "INPUT MODE," then press the cursor +/- key to select the input mode.

If the input source is RGB, refer to "Setting INPUT MODE to YCbCr" on page 24.

If the input source is VIDEO or S-VIDEO, the following two types can be selected:

- GRAPHICS for displaying a graphic image, or
- TEXT for displaying a text image such as the image from the document camera.

- 10 Press L-CLICK.
- 11 Press the cursor ▲/▼ key to select "WHITE PICTURE," then press the cursor +/- key to select the white picture mode.

The following two types can be selected:

- NORMAL, or
- QUIET to reduce brightness for better color expression,

- 12 Press L-CLICK.

Selecting the wide screen display

- 1 Carry out the steps 1 to 6 above.
- 2 Press the cursor ▲/▼ key to select "DISPLAY MODE," then press the cursor +/- key to select "WIDE" for wide screen display or "NORMAL" for normal screen display.

Activating the power saving function

This function operates only with an RGB input source.

If the input signals from the RGB IN connector go down for more than five minutes, the unit will automatically turn off and enter the standby mode.

- 1 Press MENU to display the main menu.
- 2 Press the cursor ▲/▼ key to select "POWER MENU."
- 3 Press L-CLICK to display the POWER MENU.
- 4 Press the cursor ▲/▼ key to select "POWER OFF," then press the cursor + key to select "ON" to activate the power saving function.

To deactivate the function, set "POWER OFF" to "OFF" by pressing the cursor - key.

Quick starting the unit

The unit can be turned on just by only switching on the main power on the unit (see step 1 on page 16). There is no need to press the POWER ON button on the remote control or the POWER button on the unit.

- 1 Press MENU to display the main menu.
- 2 Press the cursor ▲/▼ key to select "POWER MENU."
- 3 Press L-CLICK to display the POWER MENU.
- 4 Press the cursor ▲/▼ key to select "AUTO START," then press the cursor + key to select "ON" to activate the function.

To deactivate the function, set "AUTO START" to "OFF" by pressing the cursor - key.

Activating the on-screen function

If you activate the on-screen function,

- The input source “VIDEO,” “S-VIDEO,” or “RGB” will be displayed for three seconds when you have selected the input source with the remote control (see page 16), and
- The message “POWER OFF/ENTER” will be displayed on the screen when you press the POWER button on the unit, if “DISPLAY” is set to “ON” for preventing the unit from being turned off accidentally.

- 1 Press MENU to display the main menu.
- 2 Press the cursor ▲/▼ key to select “SETTING MENU.”
- 3 Press L-CLICK to display the SETTING MENU.
- 4 Press the cursor ▲/▼ key to select “DISPLAY,” then press the cursor + key to select “ON” to activate the on-screen function.

To deactivate the function, set “DISPLAY” to “OFF” by pressing the cursor – key.

Turning off the unit

• Operating with the remote control

Press the POWER OFF button a little bit longer.
The unit will go off regardless of the “POWER OFF” setting.

• Operating with the unit

When “DISPLAY” is set to “ON”

- 1 Press the POWER button.
“POWER OFF/ENTER” appears on the screen.
- 2 Press ENTER.
The unit will go off.

When “DISPLAY” is set to “OFF”

Press the POWER button a little bit longer.
The unit will go off.

Canceling turning off the unit when “POWER OFF/ENTER” is appearing on the screen

• Operating with the remote control

- Press MAGNIFY – to turn off the message, or
- Press MENU to display the main menu.

• Operating with the unit

- Press ADJUST + to change the message on the screen to “POWER OFF/CANCEL,” then press ENTER, or
- Press MENU to display the main menu.

Checking hours of lamp use

The lamp housing must be replaced after 1000 hours of use. When 1000 hours have elapsed the STATUS indicator will light in red (see page 31). Periodically check hours of lamp use in the menu so that you will have time to purchase a new lamp housing before the old one is burnt out.

- 1 Press MENU to display the main menu.
- 2 Press the cursor ▲/▼ key to select “POWER MENU.”
- 3 Press L-CLICK to display the POWER MENU.
- 4 Press the cursor ▲/▼ key to select “LAMP USAGE.”
The lamp use hours will be displayed.

Resetting the lamp use hours to zero

You need to reset the lamp use hours to zero after replacing the lamp housing (see page 32).

- 1 Carry out the steps above.
- 2 Press the POWER ON button on the remote control for more than ten seconds.
“LAMP USAGE” will be set to zero.

If the unit doesn't go on because lamp use exceeds 1100 hours.

The unit is designed not to turn on after the lamp use has exceeded 1100 hours. (If the unit is in use, it will go off.) If this happened you must replace the lamp housing with a new one immediately. After replacing the lamp housing, you need to reset the lamp use hours to zero to enable you to turn on the unit.

- 1 Switch on the main power (see step 1 on page 16).
- 2 Press the POWER OFF button on the remote control for more ten seconds.
“LAMP USAGE” will be reset to zero and the STATUS indicator will go off (see page 31).

Resetting all to the factory settings

All the menu items and CUSTOM 1 to 5 memory can be reset to the factory settings except for the followings:

- LANGUAGE
- LAMP USAGE

- 1 Press MENU to display the main menu.
- 2 Press the cursor ▲/▼ key to select “SETTING MENU.”
- 3 Press L-CLICK to display the SETTING MENU.
- 4 Press the cursor ▲/▼ key to select “ALL RESET.”
- 5 Press the cursor + key for more than three seconds.
“COMPLETE” appears under the title “ALL RESET” after the reset has completed.

Troubleshooting

This section helps you resolve problems you may encounter while setting up or using your UP-1100 Data Projector.

Common Problems & Solutions

<i>Problem</i>	<i>Check These Items</i>
<i>Does not turn on</i>	<ul style="list-style-type: none"> • Check that the cord is plugged in and that the power switch on the back panel is on. (See page 16.) • Check the status light to see if the projector has overheated or the lamp usage exceeds 1100 hours. (See pages 31, 29, and 32.)
<i>No picture</i>	<ul style="list-style-type: none"> • Use the menu icons to select your source (Video, S-Video, or RGB). (See page 21.) • Ensure your cables are connected properly. (See pages 11 to 15.) • Adjust the brightness and contrast. (See page 27.) • Remove the lens cap. (See page 16.) • Is the POWER indicator blinking? (See page 16.)
<i>Image isn't square to the screen</i>	<ul style="list-style-type: none"> • Reposition the projector to improve its angle to the screen. (See page 16.)
<i>Picture is blurred</i>	<ul style="list-style-type: none"> • Adjust the focus. (See page 17.) • Reposition the projector to improve its angle to the screen. (See page 16.) • Ensure that the distance between the projector and screen is within the adjustment range of the lens. (See pages 9 and 10.)
<i>Remote control does not work</i>	<ul style="list-style-type: none"> • Install new batteries. (See page 5.) • Make sure there are no obstacles between you and the projector. • Stand within 13 feet (4m) of the projector. (See page 5.)
<i>The STATUS indicator is lit or blinking</i>	See the Status Light message chart on the next page.
<i>Cross color in RGB mode</i>	If "Auto Picture" is off, turn it on. If "Auto Picture" is on, turn it off and balance the image with the Picture Adjustment icon and Fine Picture Adjustment icon. (See page 26.)

When the STATUS indicator lights or blinks

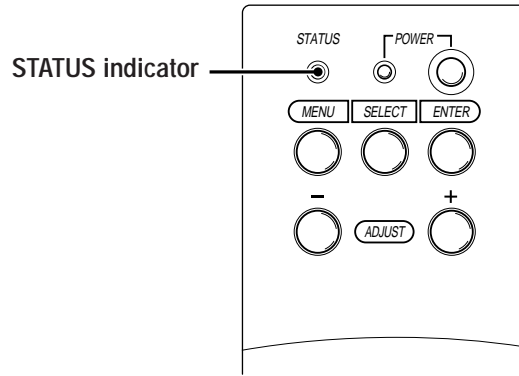

Status Light Messages

<i>Condition</i>	<i>Status</i>
<i>OFF</i>	<i>Normal</i>
<i>On Continually</i>	<i>The projector lamp has exceeded 1000 hours of operation and should be replaced.</i>
<i>Blinking Very Rapidly (On and off in a cycle of 1 sec.)</i>	<ul style="list-style-type: none"> • <i>The lamp housing is not correctly installed. Install it correctly.</i>
<i>Blinking Rapidly (On and off in a cycle of 4 sec.)</i>	<ul style="list-style-type: none"> • <i>The temperature protector has been triggered. If the room temperature is high, move the projector to a cool location. If the temperature within the projector is high, check the cooling fan ventilation hole and the ventilation hole on the bottom of the projector. If any of the holes are blocked, remove whatever is blocking them.</i> • <i>The temperature protector has been triggered. If you switch the main Power switch Off, then immediately switch it On again, sometimes the power does not come on. If this happens, wait one minute, then switch the power On again.</i> • <i>The lamp lighting voltage error detection protector has been triggered. Wait at least one minute before switching it on again. If this does not solve the problem, please contact your dealer.</i>
<i>Blinking Slowly (On and off in a cycle of 8 sec.)</i>	<i>The cooling fan has stopped. Contact your PLUS dealer for service.</i>
<i>Blinking Very Slowly (On and off in a cycle of 12 sec.)</i>	<p><i>The lamp is not turned on.</i></p> <ul style="list-style-type: none"> • <i>The projector was turned off and back on too quickly. Turn off the projector, wait one minute, then turn the projector back on. Or the lamp is burnt out.</i>

Replacing the lamp housing

After the lamp has been operating for 1000 hours or longer, the STATUS indicator on the control panel will light and "LAMP USAGE" icon which shows hours of total lamp use will be displayed on the screen. When this happens, turn off the unit and replace the lamp housing with new one. The unit will not be go on after 1100 hours. (It will go off if it is in use.)

⚠ CAUTION

- DO NOT TOUCH THE LAMP immediately after it has been used. It will be extremely hot. Allow at least one hour for the lamp to cool before handling.
- DO NOT LOOSEN ANY SCREWS except for those mentioned in the instructions below. There is danger of electric shock.

Lamp housing replacement procedure

- 1 Switch off the main power and unplug the power cord.
Wait at least one hour for the lamp to cool.
- 2 Turn the unit upside down carefully.
- 3 Loosen the lamp cover securing screw.
- 4 Slide the lamp cover in the direction of the arrow and remove it.

⚠ CAUTION: Do not use a lamp housing other than the PLUS replacement lamp housing. Order this from your PLUS dealer using your projector's model number (see "Notes" below).

- 5 Loosen the three lamp housing securing screws.
(This projector has a safety switch.)
- 6 Hold the handle then pull the lamp housing upward to remove it.
- 7 Install the new lamp housing.
- 8 Secure the lamp housing with the three screws.
- 9 Replace the lamp cover and secure it with the securing screw.
- 10 Return the unit to the normal position, connect the power cord, and turn on the unit.
- 11 Reset the lamp time.

Select the lamp usage time menu, then press the POWER ON button on the remote control and hold it down for at least ten seconds. (See page 29.)

Notes

- When the lamp usage time reaches 1100 hours, it becomes impossible to switch on the power and menus are not displayed. In such a case, press the remote control POWER OFF button for at least 10 seconds in the standby mode. It is possible to confirm whether it has been reset or not by checking whether the STATUS indicator is extinguished (See page 29).
- Obtain a replacement lamp at the store where the Data Projector was purchased. When ordering a replacement lamp, specify the UP-1100 special replacement lamp - model name UP-280DC (Product code 28-685).

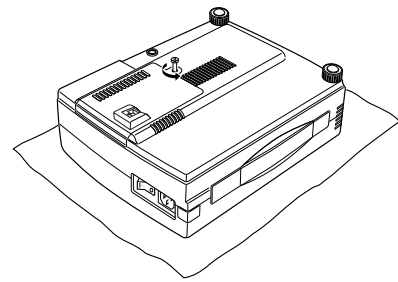

Step 3

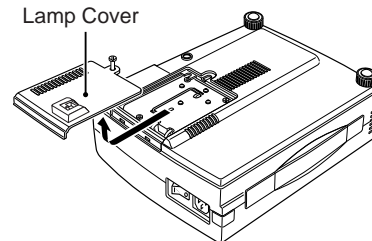

Step 4

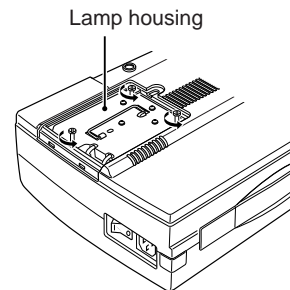

Step 5

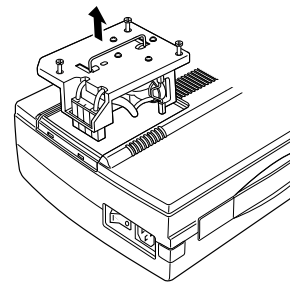

Step 6

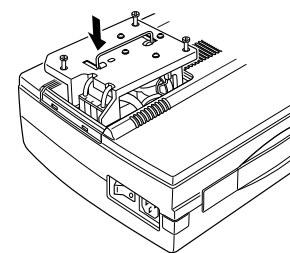

Step 7

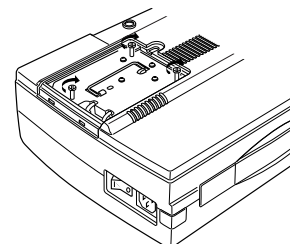

Step 8

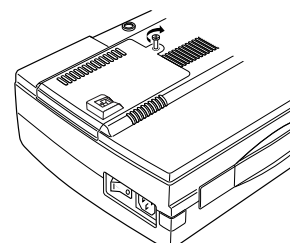

Step 9

Specifications

This section provides technical information about the UP-1100 Data Projector's performance.

Optical

DMD™	Single Chip Digital Micro Device (DMD™), 1024×768 dots
Lens	Manual zoom, manual focus F 3.0 f =35.0 to 45.5 mm
Lamp	Metal halide lamp 280 W
Image Size	610 to 7620 mm (24 to 300 inches) diagonal
Projection Distance	1.2 to 12.3m
Light Output	1000 ANSI lumens (normally white)
Contrast Ratio	500 : 1
Color Temperature	7000 Kelvin

Electrical

Inputs	Video (NTSC / PAL / SECAM / NTSC4.43) RGB (H:15 to 60 kHz, V: 50 to 85 Hz)
Video Bandwidth	60 MHz
Color Reproduction	Full color, 16.7 million colors simultaneously.
Horizontal Resolution	NTSC 500, PAL 500, SECAM 300, NTSC4.43 350 TV lines RGB 1024 dots horizontal, 768 dots vertical
Power Requirement	100 to 120/220 to 240 VAC, 50/60 Hz
Input Current	6 A/3A (400W)

Mechanical

Dimensions	25.5 cm (W) x 13.5 cm (H) x 34.0 cm (D)
Net Weight	4.8 kg/10.5 lbs
Operational Temperatures	Data projector: 5° to 35°C (41° to 95°F), 30 to 85% humidity Remote control: 0° to 60°C (32° to 140°F) Remote mouse receiver: 0° to 60°C (32° to 140°F)
Regulations	UL Approved (UL 1950, CSA 950) Meets DOC Canada requirements Meets FCC Class A requirements Meets EMC Directive (EN55022, EN61000-3-2, EN61000-3-3, EN50082-1) Meets Low Voltage Directive (EN60950, TÜV GS Approved)



Specifications (continued)

D-Sub Pin Assignments

PC 15-Pin mini D-Sub

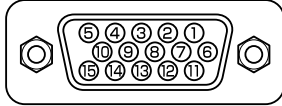

Pin No.	Signal to be connected
1	Red
2	Green
3	Blue
4	GND
5	GND
6	Red GND
7	Green GND
8	Blue GND
9	No Connection
10	Digital GND
11	GND
12	No Connection
13	Horizontal Sync
14	Vertical Sync
15	No Connection

Dimensions

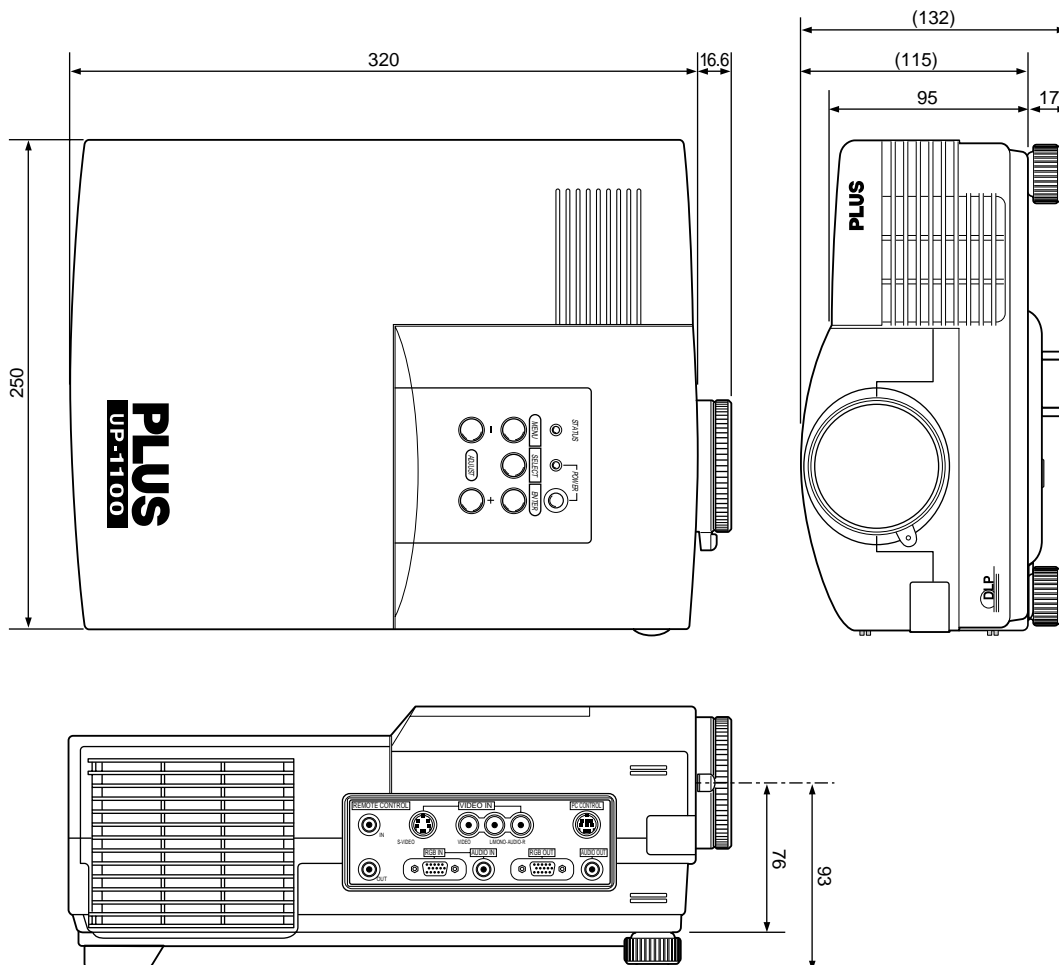

Free Manuals Download Website

<http://myh66.com>

<http://usermanuals.us>

<http://www.somanuals.com>

<http://www.4manuals.cc>

<http://www.manual-lib.com>

<http://www.404manual.com>

<http://www.luxmanual.com>

<http://aubethermostatmanual.com>

Golf course search by state

<http://golfingnear.com>

Email search by domain

<http://emailbydomain.com>

Auto manuals search

<http://auto.somanuals.com>

TV manuals search

<http://tv.somanuals.com>