

KS- 6615 / 7315 / 6617 / 7317
Fan Free Touch Terminal
w/ Slim or Super Slim Base
User's Manual

POSIFLEX

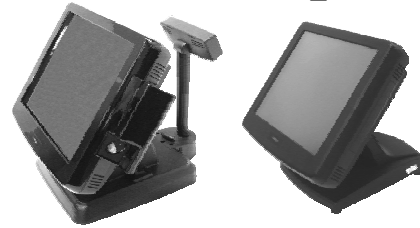

FCC Notes:

Rev.: A0

This equipment generates, uses, and can radiate radio frequency energy and, if not installed and used in accordance with the instructions manual, may cause interference to radio communications. It has been tested and found to comply with limits for a Class A digital device pursuant to subpart J of Part 15 of FCC Rules, which are designed to provide reasonable protection against interference when operated in a commercial environment. Operation of this equipment in a residential area is likely to cause interference in which case the user at his own expense will be required to take whatever measures to correct the interference.

Warranty Limits:

Warranty terminates automatically when any person other than the authorized technicians opens the machine. The user should consult his/her dealer for the problem happened. Warranty voids if the user does not follow the instructions in application of this merchandise. The manufacturer is by no means responsible for any damage or hazard caused by improper application.

About This Manual:

Posiflex has made every effort for the accuracy of the content in this manual. However, Posiflex will assume no liability for any technical inaccuracies or editorial or other errors or omissions contained herein, nor for direct, indirect, incidental, consequential or otherwise damages, including without limitation loss of data or profits, resulting from the furnishing, performance, or use of this material.

This information is provided "as is" and Posiflex Technologies, Inc. expressly disclaims any warranties, expressed, implied or statutory, including without limitation implied warranties of merchantability or fitness for particular purpose, good title and against infringement.

The information in this manual contains only essential hardware concerns for general user and is subject to change without notice. Posiflex reserves the right to alter product designs, layouts or drivers without notification. The system integrator shall provide applicative notices and arrangement for special options utilizing this product. The user may find the most up to date information of the hardware from web sites: <http://www.posiflex.com> or <http://www.posiflex.com.tw> or <http://www.posiflexusa.com> All data should be backed-up prior to the installation of any drive unit or storage peripheral. Posiflex will not be responsible for any loss of data resulting from the use, disuse or misuse of this or any other Posiflex product.

All rights are strictly reserved. No part of this documentation may be reproduced, stored in a retrieval system, or transmitted in any form or by any means, electronic, mechanical, photocopying, or otherwise, without prior express written consent from Posiflex Technologies, Inc. the publisher of this documentation.

© **Copyright Posiflex Technologies, Inc. 2008**

All brand and product names and trademarks are the property of their respective holders.

P/N: 16560900020

Part 1

ALERT TO OUR HONORABLE CUSTOMERS:

- Please always read thoroughly all the instructions and documents delivered with the product before you do anything about it. Don't take any premature action before you have a full understanding of the consequences.
- This product contains inside a Lithium battery and maybe also a sealed type Lead acid battery if the UPS battery option is ordered. Please always follow local environmental protection laws / regulations for disposal of used batteries and always replace only with battery of same type.
- If you have an UPS battery installed in the product:
 - ✧ Temperature above **40°C must be strictly avoided** as it could cause termination of battery life and unexpected result even if the battery is not in work.
 - ✧ **Do not** power off the system just by shutting off the AC power leaving the battery supporting the whole system till completely exhausted. **Repeatedly using it up or improper maintenance reduces the battery life dramatically.**
 - ✧ Always fully recharge the battery at least once every 3 months if the battery is not connected.
 - ✧ Always **disconnect the UPS battery** from the system if the system is to be left OFF for more than **72 hours** to prevent possible damage. Only connect the UPS battery back right before you are going to re-power on the system.
 - ✧ Replace the battery as soon as the monitoring software indicates the battery is out of service. Attempt to recharge a dead battery is **dangerous!**
 - ✧ A separate battery monitor is not required for this series.

DAILY MAINTENANCE GUIDE

For regular cleaning of the KS systems, please use only soft haired brush or dry soft cloth. You may use moist soft cloth to remove stains when necessary. Apply only proper amount of mild neutral detergent for obstinate stains. Please note that never use Acryl dissolving solvent or Polycarbonate dissolving solvent. You may apply ammonia-based glass cleaner only on the screen surface.

CAUTION

**Risk Of Explosion If Battery Is Replaced By An Incorrect Type
Dispose Of Used Batteries According To Local Regulations**

INTRODUCTION

PRODUCT PICTURES

Front Views

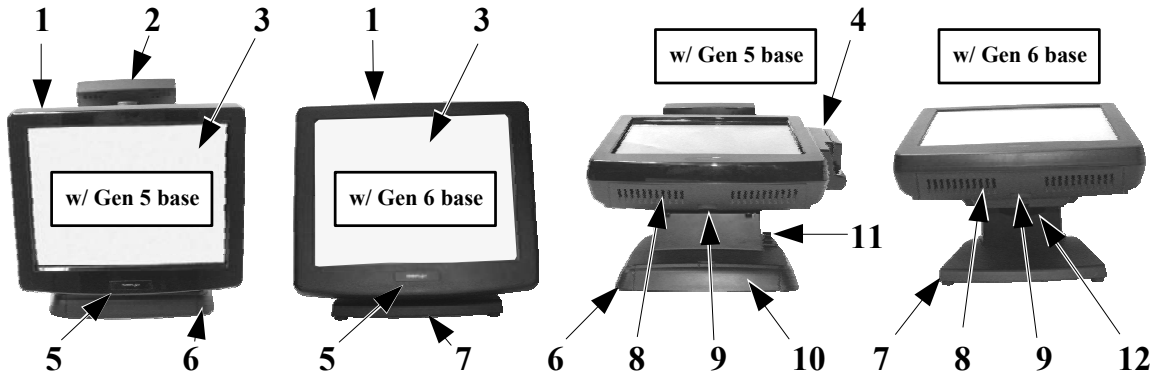

Side Views

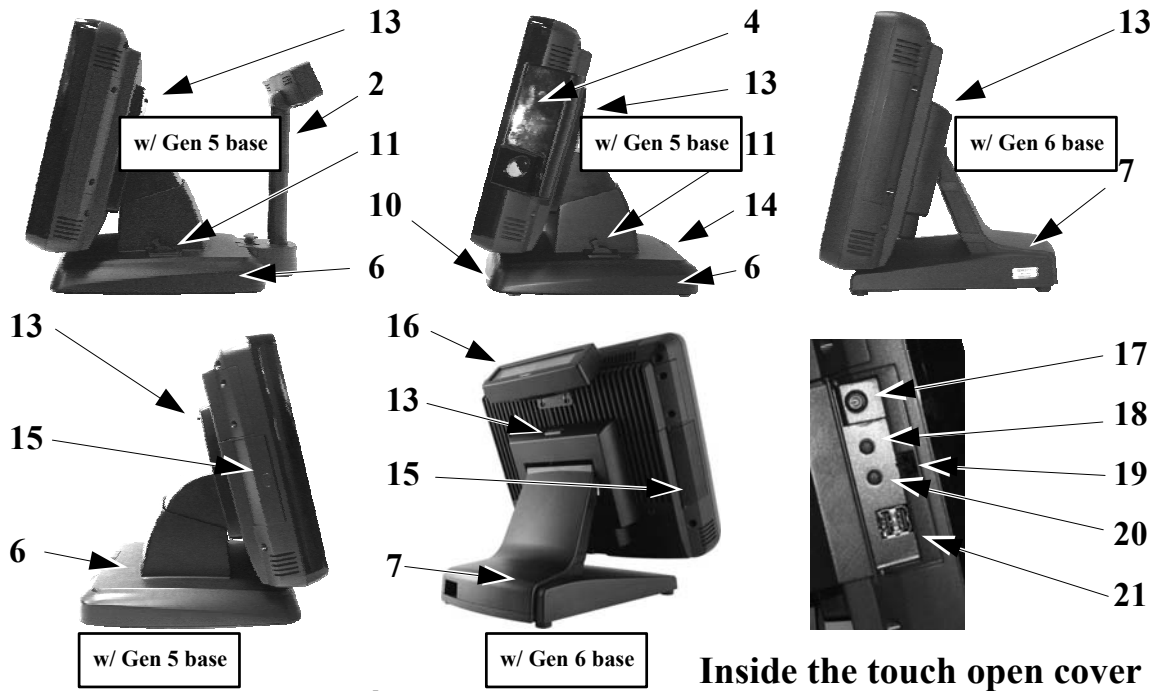

Rear Views

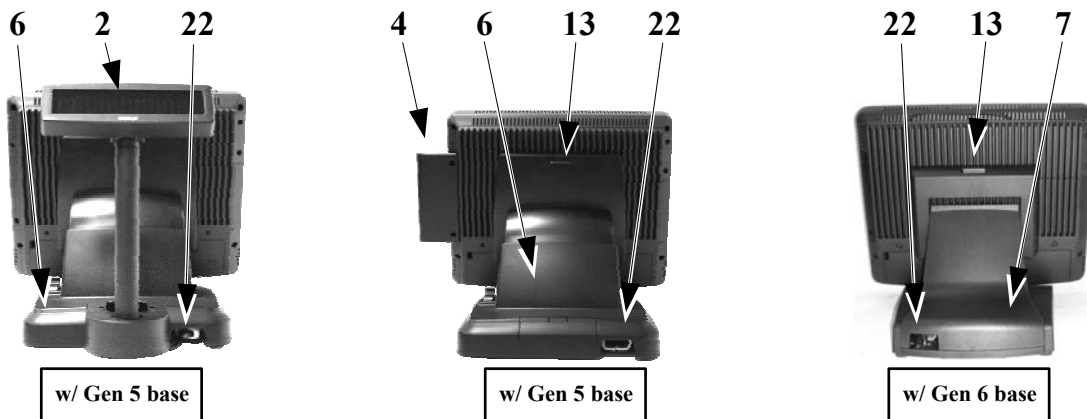

Inside the touch open cover

Bottom Views

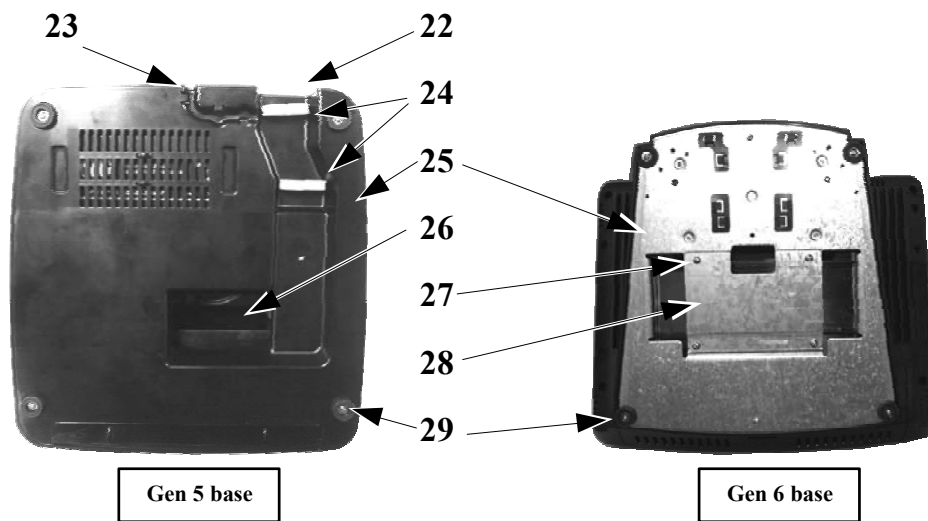

PARTS IDENTIFICATION

1. Main unit
2. Optional base mount kit e.g. PD-306 for Gen 5 Slim base model
3. Touch panel / LCD panel
4. Optional side mount kit e.g. SD-400T for glossy front surface model or SD-400W for textured front surface model
5. Power indicator (Logo)
6. Gen 5 Slim base stand
7. Gen 6 Super Slim base stand
8. Cable cover
9. Removal hollow in cable cover
10. Front cover of Gen 5 Slim base (for service convenience only)
11. Lock / release lever for tilt angle adjust in Gen 5 Slim base
12. Cable passage on trunk of Gen 6 Super Slim base
13. Lock / release button for main unit detach
14. Rear connect cover
15. Touch open cover
16. Optional top mount upgrade kit e.g. PD-310 or PD-2604
17. Power switch
18. Brightness adjust push button “+”
19. Touch open door latch
20. Brightness adjust push button “-”
21. Double deck USB ports
22. Cable exit
23. Base mount device cable groove (for Gen 5 Slim base)
24. Cable holder
25. Bottom plate
26. Cable passage in bottom plate of Gen 5 Slim base
27. UPS battery bracket fixing screw
28. UPS battery bracket
29. Rubber feet with bottom plate fixing screw

PRODUCT FEATURES

Standard Features:

- a) Applicable CPU:
 - 1. for KS-6615 only: Intel Celeron M 1.0 GHz
 - 2. for KS-6615 / 6617: Intel Celeron M 1.5 GHz
 - 3. for KS-7315 / 7317: Intel Celeron M 1.86 GHz or Core Duo 2.0 GHz or Core 2 Duo 2.16 GHz
- b) Fan free structure with Aluminum main unit for harsh environment
- c) Data storage device: SATA HDD 2.5" 40 GB in base stand or SATA HDD 2.5" 40 GB in main unit or CF card.
- d) An advanced Gen 5 slim base design that supports 2nd LCD display or pole mount customer display, storage room for 2.5" HDD and optional UPS battery or a Gen 6 super slim base design that supports pole mount customer display, storage room for 2.5" HDD and optional UPS battery. Also possible to be without base but with wall mount bracket for wall mount application.
- e) Support WinXP Pro, WEPOS and Linux OS for KS-6615/6617; support WinXP Pro, WEPOS and Windows Vista for KS-7315/7317 (Vista 64 bit for Core 2 Duo CPU model only)
- f) High quality 15" TFT active matrix LCD panel for KS-6615 / 7315. High quality 17" TFT active matrix LCD panel for KS-6617 / 7317
- g) Brightness control by either software or hardware of 2 push buttons in side cover
- h) **Vertical type LCD panel with easy tilt** angle adjust from 15° to 70°
- i) Durable resistive type (leading edge Infra Red type optional) touch panel that endures 35 million touches min. at same spot
- j) Spill proof water resistant structure allowing easy cleaning
- k) Easy maintenance construction
- l) Various I/O ports supported, including:
 - 1. 4 serial ports with capability for +5V DC support in form of DB9 connectors.
 - 2. one parallel port
 - 3. 4 standard USB ports in I/O area plus 2 in side cover
 - 4. one proprietary USB port for optional side mount kit (e.g. SD-400W)
 - 5. one LAN port Ethernet 100/1000 Base T with LAN status indicators on jack (green for link, orange for data transmission)
 - 6. one external VGA monitor port
 - 7. one CR port for control over max. 2 cash drawers
 - 8. one Mic. in / audio line out port
 - 9. one SATA data port plus one HDD power connector
 - 10. one 4 pin lock type DC 12 V power input connector

- 11. one UPS battery connector
- m) **Touch control functions:** left/right button, double click, drag & draw
- n) Dual display support (per OS capability)
- o) Dynamic video memory (max. 128 MB for KS-6615 / KS-6617, max. 224 MB for KS-7315 / KS-7317)
- p) Support high performance **DDR2 DRAM** with maximum memory size **1GB** for KS-6615/6617 and **2GB** for KS-7315/7317 **in one module**
- q) Integrated structure for side mount upgrade kit like SD-400W with software programmable MSR parameters for Win XP or WEPOS
- r) Built-in 2 internal 2W speakers with stereo audio amplifier
- s) **Built-in UPS function** to support the system from intermittent power failure (battery itself is an option)
- t) **Accidental power off protection** – The power switch is safely located inside a push-open cover, and it can be defined as a “ON” switch only through software command
- u) **Preconditioned power up function** – by alarm clock or COM port MODEM ring or LAN

Option Items:

Note: The underlined items in the following list means that option must be set prior to shipment from the factory. The rest can be set by the dealers.

- a) DDR2 SODIMM memory expansion up to 1GB for KS-6615/6617 or up to 2GB for KS-7315/7317
- b) RS232 interface Infra-Red type touch panel durable for 50 million touches min. at same spot
- c) CF memory card reader slot
- d) Integrated side mount upgrade kit:
 - ✧ SD-400W/T: MSR, fingerprint reader
 - ✧ or other later developed side mount upgrade kit
- e) Integrated base mount device:
 - ✧ PD2501 or PD2602 VFD pole display for slim base
 - ✧ PD305 low profile LCD customer display for slim base
 - ✧ PD306 LCD pole display for slim base
 - ✧ PD7622 graphic LCD customer display for slim base
 - ✧ LM-6201 12.1” 2nd LCD panel monitor for slim base
 - ✧ LM-6301 15” 2nd LCD monitor for slim base
 - ✧ or other later developed base mount device
- f) Rear top mount device:
 - ✧ PD310 LCD display or PD2604 VFD display
- g) UPS battery in base
- h) Preload OS
- i) Wall mount kit: WB-6000VB, WB-6300, WB-6600, WB-6800

INSTALLATION GUIDES

CAUTION: Before any installation or cable connection to the set, please always make certain that the system is turned off and the external power source to the set is removed to prevent electric hazard! Never touch any metal pin in the connectors or circuits to avoid high voltage hazard or electrostatic discharge damage unless the operator is well grounded. Failure to do the above will void the product warranty!

OPENING CABLE COVER

Please follow steps A to C sequentially with reference to pictures below to remove the cable cover for Gen 5 slim base models and steps B and C for Gen 6 super slim base models.

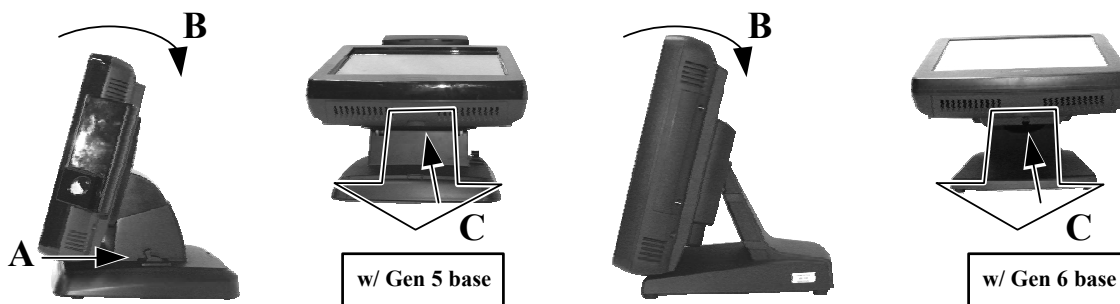

Step A: Push lock/release lever of the Gen 5 slim base for tilt angle adjust backward. (This operation is not required in Gen 6 super slim base)

Step B: Turn panel to most horizontal position

Step C: Pull at the removal hollow toward the user

- Tips:**
1. If there is trouble removing the cable cover, try pressing the arrowed portion of cable cover in the rear view picture at right at the same time.
 2. If there is still trouble removing the cable cover, don't force open it. Consult your system administrator if it has been locked on purpose.

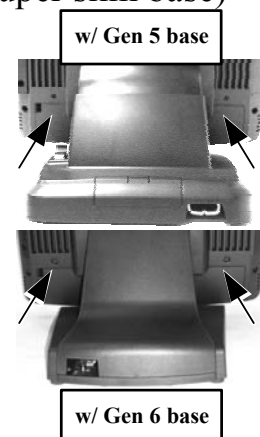

DISCONNECTING ALL CABLES

After removal of the cable cover, the I/O connector area will be accessible then. Please **first note orientations of every existing cable connection** and then disconnect every cable properly before separating the main unit from the adjustable stand assembly. Please note that the click lock spring has to be pressed down prior to pulling out the connector such as the LAN port or the CR port. Please also note that the fixing screws have to be loosened free prior to disconnection such as the LPT port or COM ports. Please **always hold the connector head** instead of pulling on the cable wire

when disconnecting any connector. Failure to do this could damage the cable and jack that is considered as an **artificial destruction**. **Damages due to incorrect disconnection operation are not covered by product warranty!**

SEPARATING MAIN UNIT

In order to settle the touch terminal properly in a point of sale system, all the cable connections have to be routed through its base. Therefore, please observe the procedures from A to C below to separate the main unit from the base stand assembly after all cables in cable cover disconnected.

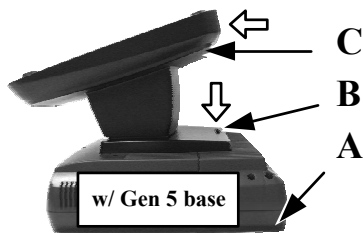

Step A: Prepare a soft clean flat surface, such as a piece of cloth on the desk to seat the front surface of main unit after being adjusted to most horizontal position

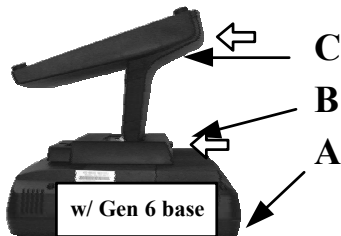

Step B: Press the Lock/Release button for main unit detach and meantime ...

Step C: Slide the base stand assembly to left to separate the main unit from base stand

OPENING SLIM BASE BOTTOM

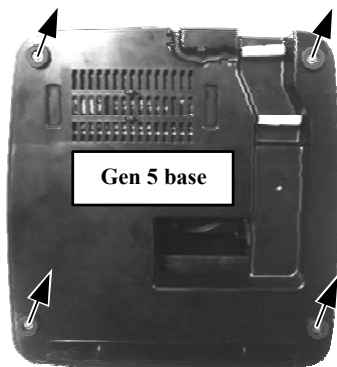

Take the adjustable stand assembly of the gen 5 slim base and turn it up side down to show the bottom of the base. Remove the bottom plate fixing screws in center of rubber feet to remove the bottom plate. For maintenance operation that there are already some cable connections, please release the cables from the 2 plastic cable holders and have all cables to pass through the cable passage in bottom plate as in the left picture.

INSTALLING UPS BATTERY (OPTION)

The optional UPS battery is delivered in the carton if it is ordered. For



slim base model, please refer to the left picture and place the UPS battery in the cavity in base with the rectangular marked end first. Route the battery connection cable together with all other external connection cables through the arrow marked passage to the battery connector on the main unit. If the optional cable clip is available, insert it into a hole marked in circle in the picture and use it to hold the

battery cable. The UPS battery will be held in place when the bottom plate is screwed back. As for gen 6 super slim base model, please remove the UPS battery bracket on bottom of the stand assembly instead of the bottom plate as in the right picture.

Please pay particular attention to the environment requirements for UPS battery in next chapter “USING THE TOUCH POS”.

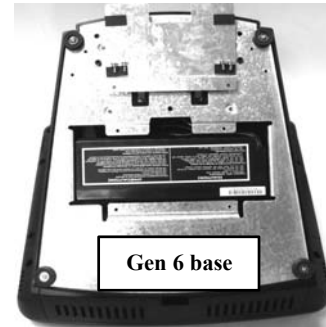

BASE MOUNT UPGRADE KIT (OPTION)

On rear top edge of the gen 5 slim base stand assembly for desktop mount application, there is a rear connect cover as marked in the right picture. It can be removed by pressing the center part down. Either a 2nd LCD display panel option LM-6101 (12”) or LM-6301 (15”) a VFD customer display option PD-2501 or PD-2602/U or a LCD customer display option PD-305 or PD-306/U or PD-7622 can be installed here after removing this cover.

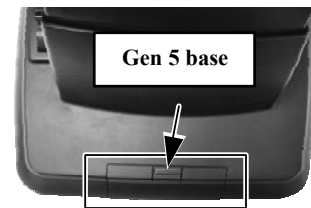

Please note that for KS-6617/7317, there could be much more restrictions to the tilt angle range for the main unit due to larger dimensions of the LCD panel if base mount upgrade kit mounted. Investigation for the acceptability of such kind of restrictions must be taken before decision to install a base mount upgrade kit to these models.

Fit the joint base of PD-2501, PD-2602, PD-305, PD-306/U, PD-7622 or LM-6201 or the interface bracket of LM-6301 to the rear connect cover opening. Fit 2 screws with washers to hold the joint tight as in the picture at right. Then insert the cable into the base mount device cable groove and cable holder on bottom plate and connect to the main unit through the base. For low profile customer display PD-305, the display unit is right on joint base without the pole.

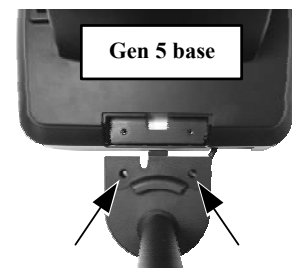

Remember to enable the +5 V DC supply in the COM port of the main unit for PD-2501, PD-2602, PD-305, PD-306 or PD-7622 or the +12 V DC in VGA port for LM-6201 or LM-6301. PD-306U will be powered through the USB port without specific setting.

ROUTING THE CABLES

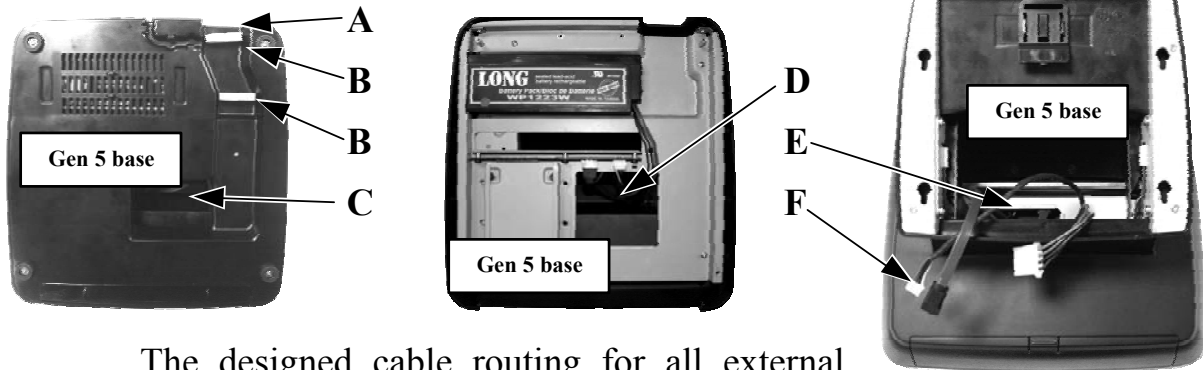

The designed cable routing for all external cable connections referring to the pictures above is to have all the cables coming from outside into the cable exit (position **A**) at bottom side of gen 5 slim base and to be regulated into the two cable holders (**B**) then enter the base through the passage (**C**). The cables should then go through the passage (**D**) at top of base box and get out of the base assembly through the opening (**E**) for connection to the main unit. Place all the cable ends (**F**) to be connected to main unit to come out of the opening (**E**) from the bottom edge for ease of later operation. Be sure not to damage any cable during this operation.

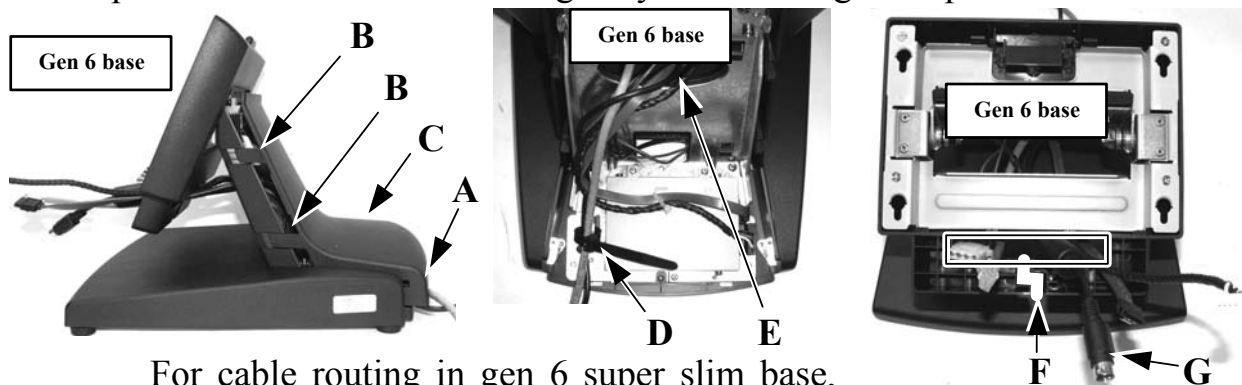

For cable routing in gen 6 super slim base, please refer to this set of pictures above. To have all external cables pass through cable ext (**A**), please release 2 hooks (**B**) each side over the base trunk to remove the back cover (**C**) of base. Inside the base trunk hold all the external cables with the cable tie (**D**) and have all cables together with the HDD cables to pass through an oval hole (**E**) to come out of the front side of trunk. Please do not loose off any HDD cable in the operation. Slide each cable through the twisted passage (**F**) to enter the rectangular marked rest area for all the cable ends (**G**) to be connected to main unit. Be sure not to damage any cable during this operation.

PREPARING THE MAIN UNIT

On the back of the main unit, there is a service window among the 4 matching pegs. Remove the service window lock screw to flip open the cover plate and find several jumpers as illustrated below. The jumpers in this

window are designated for VGA port and COM port power supply function. Please consult your dealer for technical support on setup of these jumpers. Please note that only those qualified technicians may adjust in the service window with information from Posiflex and the contents in the service window may change without notice as time develops.

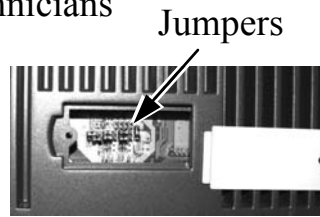

SIDE MOUNT UPGRADE KIT (OPTION)

Remove the 2 screws circled in last picture above to remove the cover for side mount upgrade kit. Take out the cable inside this cover and connect it to connector inside the side mount upgrade kit like SD400T as circled in the right picture. Gently arrange the excessive length of this cable back in the hole and screw-fit it back to the position originally occupied by the cover. Please reserve the cover if there is chance to have the side mount kit removed in the future.



REAR TOP MOUNT UPGRADE KIT (OPTION)

To mount the rear top mount upgrade kit like PD-310 or PD-2604 on the back of KS series, please apply carefully the 2 small fixation shoulder screws that come along with PD-310 or PD-2604 to the back of KS series at the screw hole triangle marked in the right picture. However please do not screw them to the bottom but at a position that is about 1 turn loose from the bottom. Similarly please loosen the screws by 1 turn for some models with these 2 screws preinstalled. Arrange the interface cable of the rear top mount upgrade kit to go into **the first groove to the right of the left shoulder screw** on back of main unit as in the above right picture. For gen 6 super slim base models, please stick the 2 attached cable clips at arrowed positions in the picture for cable routing when later joining the main unit to gen 6 base. Hook the rear bracket of the upgrade kit onto the shoulder screws. Slide down the upgrade kit and gently tighten the shoulder screws. **Do not overdo the tightening or unrecoverable thread damage will occur.** Remember to enable the +5 V DC supply in the COM port of the main unit for the upgrade kit if the serial interface model is used. The power supply in the I/O port must be disabled if it is no longer to support these intended devices otherwise **any damage or loss caused consequently shall be out of product warranty!** However, if the customer display used is the USB interface model,

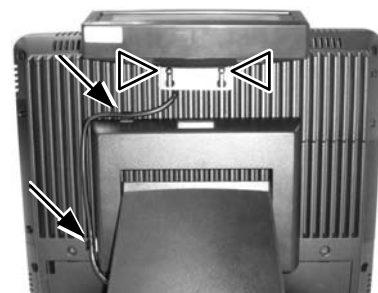

the DC supply in COM port is not required, it will be powered through the USB port.

CONNECTING CASH DRAWER (OPTION)

The RJ11 connector in main connection area of a KS system can be used for controlling most of the common cash drawers available on the market. However, it is most recommended that the Posiflex CR-2000 or CR-2200 or CR-3100 or CR-3200 or CR-4000 or CR-4100 or CR-4210 or CR-6210 be used for best compliance.

The KS system will directly control the cash drawer using the cash drawer port (CR) both to operate the opening mechanism and to monitor the drawer open status. Both functions may be accomplished under software control of the COM1 serial port.

Use the cable supplied with the cash drawer (Part No. 21863018010) for connection to the CR port in KS system. This cable has a 6-pole plug at one end and an 8-pole plug at the other. The 8-pole plug should be inserted into the connector marked: "signal cable from POS Printer" at the rear of the cash drawer. The 6-pole plug should be inserted in the connector marked "CR" found in the main connection area in the system.

The user may also use the optional 2-in-1 cash drawer control cable CCBLA-238 to control 2 cash drawers in 1 port. It has a 6-pole plug at one end and two 8-pole plugs at the other. The 6-pole plug should be inserted in the connector marked "CR" found in the main connection area in the system. Each 8-pole plug should be inserted into the connector marked "signal cable from POS Printer" at the rear of one of the cash drawers. The cable lengths for the two 8-pole plugs are different. Use the shorter one for the original cash drawer "CR1" and use the longer one for the extended cash drawer "CR2" that will be distinguished by the software command.

DESKTOP MOUNTING

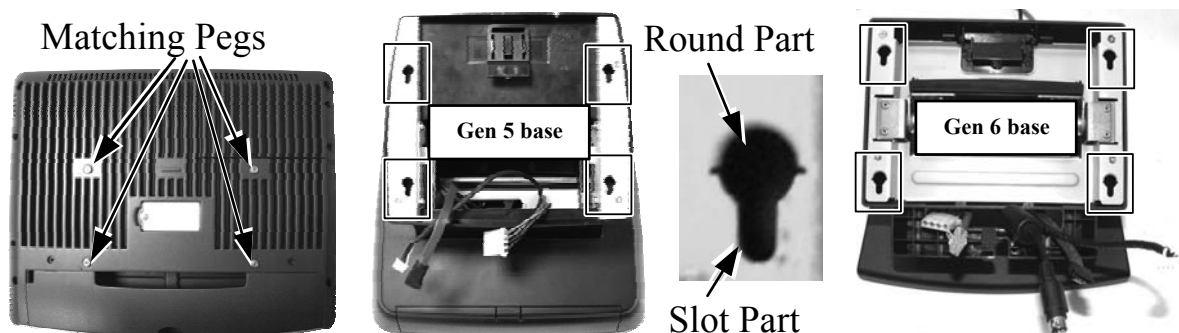

Match the matching pegs on the back of the main unit against the (rectangular marked above for both base types) matching holes on the stand assembly. First aim the matching pegs toward the upper round part of the hole (ref. the close-up illustration) and make sure that all pegs are inside the holes.

Then slide the main unit down to move the pegs into the lower slot part of the holes till it clicks. Note that all the cables come out of the stand from the lower edge and won't get trapped by this mounting operation. If later on you want to remove the main unit from the stand, you'll have to press down the lock/release button on back of the stand at the time lifting the main unit.

For desk top/counter application, the body of KS-6615/7315 occupies a space of 378 mm wide, 304 to 321 mm deep and 294 to 362 mm high per main unit tilt angle. The KS-6617/7317 is 426 mm wide, 354 to 326 mm deep and 319 to 418 mm high. The minimum height of above models shall be increased by about 4.5 mm if InfraRed type touch panel is used.

WALL MOUNTING

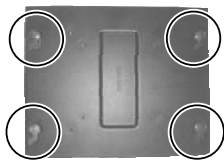

WB-6000VB

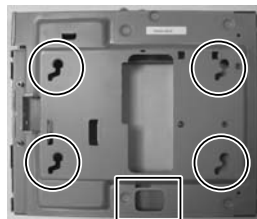

WB-6300

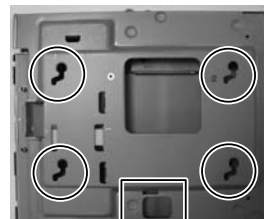

WB-6600

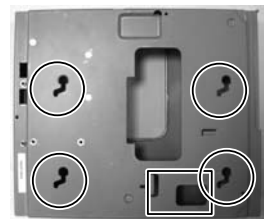

WB-6800

Select a flat surface on wall of adequate strength and with proper ventilation and space condition. Please use the right material to hold this terminal according to the wall material (Drywall, concrete, solid wood, etc). Consult with your contractor if it is necessary. A fully equipped system may weigh up to 11 kg or 23 lbs. Please fix WB-6000VB at the holes inside the guide holes circled in the picture to the wall or fix it to a VESA joint at bosses on back side.

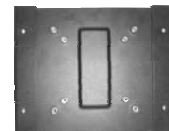

Back side of WB-6000VB

For WB-6300, WB-6600 and WB-6800 please separate the back cover of the wall mount bracket kit and fix it to wall at the 3 or 4 arrowed holes as appropriate according to these pictures at right per type of back covers with proper materials and proper preparations. Install required optional device kits with their mechanical fixation parts in the wall mount bracket and hang the backpack to the back cover that is already fixed on wall with the cables coming out of the brackets through the openings marked with rectangles in the top row pictures above. Screw lock the top side of the backpack.

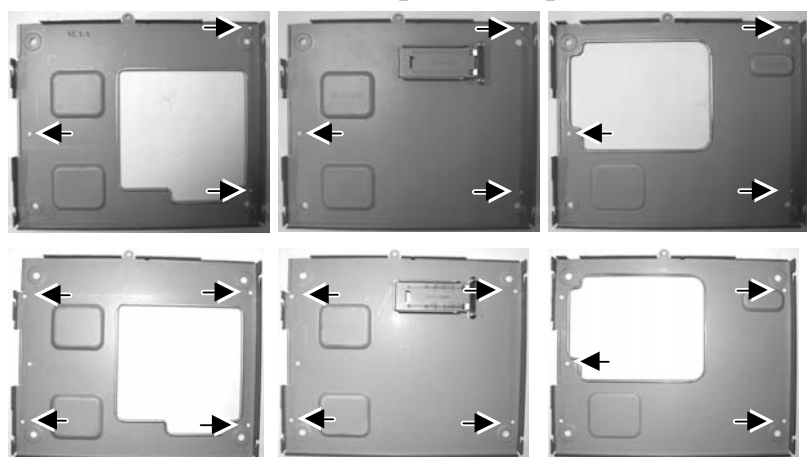

Align the four matching pegs on the back of the main unit as circled in the below left picture with the four matching holes in the wall mount brackets as also marked in circles in the top pictures and allow the main unit to slide down the winding grooves in the wall mount backpack. Connect all cables coming out of the backpack into the cable cover area of main unit.



The area required for wall mount application is determined by the main unit dimensions and is 378 mm in width and 312 mm in height for KS-6615/7315 and is 426 mm in width and 370 mm in height for KS-6617/7317.

CONNECTING CABLES

To have the re-assembled main unit with stand assembly ready for operation, please connect all required cables to the appropriate connectors. Please make sure that each connector is connected to the correct port with the correct orientation. **Damages due to incorrect connection or orientation are not covered by product warranty!**

Some connectors like the LAN or CR connector have to be gently inserted until a click is heard. It is recommended that connectors such as the COM, external VGA and LPT connector be screwed into place once seated.

Adjust the slack of each cable and close the cable cover. Re-adjust the tilt angle of the screen for best viewing.

Connect the cables to appropriate external devices through the cable exit at the bottom of stand assembly. Please make sure that each connector has to be connected to the right device in the right way.

CAUTION: On doing any insertion or extraction of any connector, please always hold the connector head itself instead of pulling on the cable wire. Failure to do this could damage the cable and jack that is considered as an artificial destruction and is not covered by the warranty.

OPERATING SYSTEM RECOVERY

For KS systems with operating system in the Compact Flash Card, once the Compact Flash is damaged for any reason, the thin client may fail to boot. **A bootable new Compact Flash Card will be required to have the workstation back to work.** Please follow instructions given by the System Integrator to deal with situations like that. One more advice for CF Card application is that in spite of the fact that it is used in the way like an ordinary HDD, usual utilities such as **FDISK.EXE** or **FORMAT.COM** shall never be used on CF Card otherwise the boot sector of operating system itself may be damaged and causing the CF Card no longer bootable.

For KS systems preloaded with Windows XP Pro or WEPOS on HDD, Posiflex provides recovery CD or DVD delivered with the touch terminal for the preloaded operating system. The System Integrator shall take care of software restoration after OS recovered. A Posiflex supplied USB interface CDROM drive will be required for such action. Other brand CDROM drive may require its specific driver different from what supported in the recovery CD or DVD.

Please use the recovery CD or DVD in rescue operation only. Using it otherwise may wipe out whatever stored in the HDD! All upgrade devices drivers needed for manual installation in usual way are available in the subfolder “\drivers” in OS recovered HDD and the latest versions of these required drivers will be available on our web: <http://www.posiflex.com.tw>. Then follow instructions from your system integrator for software recovery.

OPERATING SYSTEM INSTALLATION

This product is a highly professionalized equipment. The installation of an OS into a machine without any preloaded OS could yield major difficulty or obstacle for average user by possibly unintentional negligence even for PC veterans to accomplish such a task. Therefore, OS installation into a system without preloaded OS is highly discouraged. Posiflex shall not be responsible for any technical support to questions arisen due to non-preloaded OS.

USING THE TOUCH TERMINAL

APPLICATION ENVIRONMENT

It is **very** important that you check the following operational guidelines:

Ventilation

This terminal must **NOT** be operated in an environment with restricted ventilation. There must be at least 25 mm air clearance around any top or side ventilation holes with a free flow of air around the unit at **ALL** times for the installation.

Operating Environment

The equipment must not be operated or stored in extremes of both temperature and humidity/moisture. (Operating range 5°C to 40°C and up to 80% humidity – non condensing, max. wet bulb 26°C)

UPS Battery (option)

General care:

The UPS battery is consumables beyond product warranty. Please definitely observe the alerts in beginning of this manual. If the equipment is to

be powered off for more than few days, please always **disconnect** the battery from the system. Reconnect it and turn on the system to recharge the battery for 1 ~ 2 hours every 3 months for temperature lower than 30°C. Recharge for 1 ~ 2 hours every month for temperature over 30°C. Temperature above **40°C must be strictly avoided** as it could cause termination of battery life and unexpected result even if the battery is not in work. The UPS battery can support basically the data preservation and smooth running of the system during intermittent or few minutes (up to 30 min. depending on loading and battery condition) power failure.

Battery replacement:

In the preloaded OS for a KS system, there is a built in utility Power Manager that will interface the UPS battery monitor status with user. When battery monitor disables the battery charging as designed while the UPS function of the system is originally enabled, in other words the UPS battery is found out of order if actually installed, there will be a popup message as the picture at right asking the user to agree disabling the UPS function. The system will operate under deactivated UPS function no matter agreed or not. However, the monitoring goes on and the popup message will come back on next system power up boot if not agreed. In any case, please replace the used up UPS battery at power off if the battery is well connected there but found inoperable by such messages.



Emergency treatment:

The battery is constructed maintenance free and leakproof. It is well protected in KS system as long as the ambient temperature remains below 30°C and the ventilation of the KS system remains free. However, should any accident happen and the sulfuric acid from the battery spills on skin or clothing, wash immediately with water. If the acid comes in contact with eyes, rinse eyes with large amount of clean water and see a doctor immediately. A larger external battery may be connected to give an extended operation. Please check your dealer about this capability when required.

WARNING:

If there are any signs of over charging or leakage of electrolyte please contact your dealer immediately

Power Supply

The operating voltage range of the power adaptor should cover the local power supply for proper operation. The power cable, the power outlet and any power fusing arrangements must conform to local safety regulations.

Please **never do any connection / disconnection** when system is still powered on. **Please always keep the external power adaptor in a free air circulation.**

POWER ON/OFF & BRIGHTNESS CONTROL

Touch Open Cover

A gentle tap on the touch open cover at left side of the main unit will open the cover and show the power switch, brightness adjust push button switches and a double deck USB connector. Each single press on the + or – button changes the LCD panel display brightness by a small amount. When you press and hold the button the change will keep on until release or extreme condition matched. It is preferable to keep this cover closed in daily operation. The LCD brightness can also be controlled through software setting.

There must always be at least 10 seconds waiting before switching on again once the system is powered off successfully.

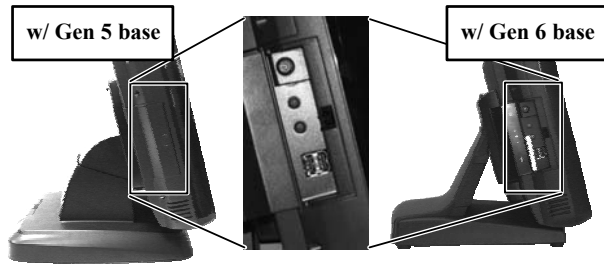

Power Indicator



There is an power indicator LED module serving for several purposes under the logo at center of lower rim of LCD panel. The relationship between the indicator status and other conditions is summarized in following table:

Indicator Status	System Status	External Power	UPS Battery	Powering Up
Off	Off	Off	Not present	Not possible
Off	Off	Off	Present	Not allowed
Green	Off	On	No influence	Allowed
Blue	On	On	No influence	Not required
Blue/flash	On	Off	Activated	Not required
Green/rapid flash	On	Off	Running at low capacity	Not required

Hardware Power Switch

The power switch located in the touch open cover of the main unit is a tactile pushbutton switch. This switch controls the power on/off of the system. This switch turns the system on when pushed only when external power is present. This switch turns the system off when pushed again during power on status. However, if the system hangs due to any reason such as software resource conflict a simple push on the switch may fail to turn off the power. In this case, please utilize the **forced power off feature** by pressing the switch and holding for within 10 seconds. In case the turmoil is so vigorous that some hardware registers may be confused causing trouble for system restart or even

this forced power off, please disconnect the UPS battery if installed and the AC power supply for few minutes. This may reset all hardware registers.

This switch can also be programmed as an ON only switch. That means, if the application program issues a command compliant with the KS series technical manual, this switch will always turn the system on when activated, but will not power off the system when pushed again (the forced power off feature will not work in this mode). When using this feature, please make sure that the software application has the ability to power off the machine. In preloaded Windows, “Posiflex Power Switch Manager” in “Posiflex Tools” in the Program Files helps managing these functions.

Software Support Features

The KS series provides a software power off command for application program maneuvers. The KS also provides a specific means for the software to detect if the system is working on external or UPS battery power. Due to this feature, compatible software applications have the ability to change operating conditions when running on standard/backup power. The software programmer may take reference from the KS technical manual to apply such features.

Automatic Power On Control

The system may also turn on according to some preset conditions such as Modem Ring Up and Alarm Clock Wake Up or LAN Wake Up.

To utilize Modem Ring Up or Alarm Clock Wake Up function, the user should enter the BIOS setup by pressing “Del” key at system boot up, choose in “Power Management Setup” and make the “Power On by Ring” enabled for Modem Ring Up or enable the “Resume by Alarm” for Alarm Clock Wake Up. Save the configuration and exit the BIOS setup program. The Preset Power On Control will then be ready. For LAN wakeup, the item “Wake-Up by PCI card” must be enabled in “Power Management Setup” and an operating caller system connected through LAN to the system is required. It also requires a qualified networking technician to check the LAN chip ID of the system for the caller system to wake up.

When the KS system is turned off after a successful boot up, the preset automatic power on functions will keep monitoring for the preset conditions and turn on the system when the preset conditions are met.

Please note that if the KS system is improperly turned off before a complete boot up procedure, the above preset power on control functions will be disabled until next turning off after a complete boot up.

CUSTOMER DISPLAY

Please follow the instructions on the manual that comes along with the customer display when it is installed.

DISPLAY ISSUES

Main LCD Display

For best viewing result please set your display resolution at 1024 x 768 with high color for KS-6615/7315 and set it at 1280 x 1024 with high color for KS-6617/7317.

The system supports Dynamic Video Memory Technology. To allow the OS to utilize this feature, please select “Advance Chipset Features” in BIOS setup and select in “DVMT Mode” as “DVMT” or “BOTH”. The maximum selectable “DVMT / FIXED Memory Size” is 128MB for KS-6615/6617 and is 224MB for KS-7315/7317.

VGA Port

The VGA port in the KS system supports TM4115 touch monitor, LM6212 LCD monitor or TM7112 touch monitor if there is no base mount 2nd LCD display. This port supports either mirror mode (identical image) or extended mode dual display function for WinXP. To support the DC power to these Posiflex monitor, use the DC adaptor to connect into the monitor (for TM-4115 / TM-7112) or its VGA cable (for LM-6212) or use Posiflex VGA + power cable and set an internal jumper in KS main unit to supply the required power through the VGA connector (for LM-6212). **Do not connect other monitor to this port before the power in this port is disabled.**

SERIAL PORTS – COM1/2/3/4

In KS-6615/6617/7315/7317 system, there are 4 serial ports available. All can supply a +5 V DC through pin 9 after proper jumper setting change. All ports are standard RS232 serial ports as status at delivery.

When a serial Modem is to be used in KS system, it is most recommended to use any COM port other than the COM1 port for this purpose. In this way any hardware resource conflict is eliminated and the MODEM ring up function can be supported.

SOUND PORTS

The audio port in KS system is arranged to have 2 internal audio speakers with maximum audio power of 2 W at lower corners of the main unit. The internal speaker will be automatically disconnected when a plug is inserted in the line output jack.

TOUCH PANEL

All paragraphs below are applicable for models with touch panel only. The user of those models without touch panel can ignore them and consider this user’s manual ends here.

Mouse Emulation

The touch panel in KS system uses USB interface as standard. Only the optional InfraRed type touch panel model uses RS232 interface. When the touch driver is properly installed, this touch panel works exactly like a standard mouse for both interfaces. However, if the system is running under safe mode, most drivers are disabled in this mode and the touch panel calibration is therefore not guaranteed. It is recommended to use a standard USB mouse or keyboard in this mode.

All the below mentioned mouse emulation functions can be manipulated through relevant software. The system can give a beep and a click on the left button of a mouse at the point when the touch panel is touched. If the point touched is dragged across the screen surface, it works as the mouse drag and drop feature. If the point is touched, released and touched within a short time interval, it is double-clicking left button of the mouse. To obtain the effect like clicking on the right button of a mouse, touching any point on the screen surface after touching the right-click sticky button results as a click on the right button of the mouse at that point.

Posiflex USB Touch Manager

A program named “Posiflex USB Touch Manager” and a right-click sticky button tool in the program group “Posiflex USB Touch Tools” is installed in the preloaded Windows system with a USB interface touch panel controller. This program can also be obtained by download from the POSIFLEX web site.

RS232 Touch Controller

If the KS system purchased is the leading edge Infra Red type touch models, the touch controller is of RS232 interface. The “Posiflex Touch Terminal Manager” above should be disregarded. In case there is any external COM port summoned for this purpose, that COM position of the system will be covered in the connection area. **Removal of this cover will void the product warranty!!**

Once the RS232 touch controller driver is installed, the user can utilize it to control the mouse emulation. Please click “Start”, “Settings” “Control Panel” and “Elo Touchscreen” or just click the “elo” icon in tool tray to engage this utility. However, with this touch controller driver, certain display mode like full screen display of Windows DOS box should be avoided.

警告
本電池如果更換不正確會有爆炸的危險
請依製造商說明書處理用過之電池



Free Manuals Download Website

<http://myh66.com>

<http://usermanuals.us>

<http://www.somanuals.com>

<http://www.4manuals.cc>

<http://www.manual-lib.com>

<http://www.404manual.com>

<http://www.luxmanual.com>

<http://aubethermostatmanual.com>

Golf course search by state

<http://golfingnear.com>

Email search by domain

<http://emailbydomain.com>

Auto manuals search

<http://auto.somanuals.com>

TV manuals search

<http://tv.somanuals.com>