

2003

**MSX**

**Owner's Manual  
for Vehicle Maintenance  
and Safety**



**POLARIS**<sup>®</sup>  
The Way Out.

 **WARNING**

The engine exhaust from this product contains chemicals known to cause cancer, birth defects or other reproductive harm.

## **We've created a web site, just for YOU!**

- Technical tips
- New product introductions
- Event schedules
- Parts and Service Manual information
- Exciting details about The Way Out
- Racing Information

**Check it out...**

**[www.polarisindustries.com/owner](http://www.polarisindustries.com/owner)**



All information in this manual is based on the latest product data and specifications available at the time of printing. Polaris Industries Inc. reserves the right to make product changes and improvements that may affect illustrations or explanations.

No part of this manual shall be reproduced or used without the written permission of Polaris Industries Inc.

Polaris, Polaris The Way Out, and Workmobiles are registered trademarks of Polaris Industries Inc.

Copyright 2002

Polaris Industries Inc.

All Rights Reserved

# WELCOME

Thank you for purchasing a Polaris vehicle, and welcome to our world-wide family of Polaris owners. We proudly produce an exciting line of utility and recreational products.

## **Polaris Recreational Vehicles**

- Snowmobiles
- All-terrain vehicles (ATVs)
- Watercraft
- *RANGER* utility vehicles
- Victory motorcycles

## **Polaris Professional Series Workmobiles™**

- Utility Task Vehicles™ (UTVs)
- Personal Task Vehicles™ (PTVs)
- All-Surface Loaders (ASLs)

We believe Polaris sets a standard of excellence for all utility and recreational vehicles manufactured in the world today. Many years of experience have gone into the engineering, design, and development of your Polaris vehicle, making it the finest machine we've ever produced.

For safe and enjoyable operation of your vehicle, be sure to follow the instructions and recommendations in this owner's manual. Your manual contains instructions for minor maintenance, but information about major repairs is outlined in the Polaris Service Manual and should be performed only by a Factory Certified Master Service Dealer (MSD) Technician.

Your Polaris dealer knows your vehicle best and is interested in your total satisfaction. Be sure to return to your dealership for all of your service needs during, and after, the warranty period. Refer to page 101 for the part numbers of Polaris products for your vehicle.

We take great pride in our Pure Polaris Parts Apparel and Accessories (PAA), available at your Polaris dealership or through our online store at [www.purepolaris.com](http://www.purepolaris.com). Have your Pure Polaris products delivered right to your door!

# TABLE OF CONTENTS

WELCOME .....	3
TABLE OF CONTENTS .....	4
YOUR RESPONSIBILITIES .....	5
IDENTIFICATION NUMBERS .....	7
SAFETY .....	8
FEATURES and CONTROLS .....	24
EMISSIONS .....	36
OPERATION .....	38
MAINTENANCE and LUBRICATION .....	74
ENGINE TROUBLESHOOTING .....	96
POLARIS PRODUCTS .....	101
SPECIFICATIONS .....	102
WARRANTY .....	104
CALIFORNIA EMISSIONS WARRANTY	107
INDEX .....	110

# YOUR RESPONSIBILITIES

## Do Your Part

Riding your Polaris watercraft will be an enjoyable experience for you, your family and friends, but we must all do our part to ride safely and protect our environment so we can continue to enjoy this sport for many years. Please show respect for our waterways, our wildlife and other people.

## Know Your Vehicle

As the operator of the vehicle, you are responsible for your personal safety, the safety of others, and the protection of our environment. Read and understand your owner's manual, which discusses all aspects of your vehicle, including safe operating procedures.

## Take Safety Training

When you purchased your new Polaris watercraft, you received a watercraft safety video and an owner's manual. Please review this information on a regular basis. All operators and passengers should read and understand the owner's manual before riding.

Store the manual in a waterproof bag in one of the storage areas on the watercraft. If the vehicle is sold, the owner's manual and video should remain with it. If your owner's manual is lost or missing, see a Polaris dealer for a replacement.

## Obey the Rules

Familiarize yourself with all boating laws and regulations in your area. Ride only in areas approved for personal watercraft. Avoid riding near waterfront homes, wildlife areas, other boats and swimmers.

## Respect Your Neighbors

Some people may find the sound of your watercraft disturbing. Avoid making excessive noise when riding, and don't make any modifications to your watercraft that may increase the sound or emission level.

## Use Care When Refueling

When refueling in or near the water, use care to avoid spilling fuel. If you do spill, wipe it up promptly and dispose of the soiled towels appropriately.

## Use Biodegradable Products

Choose biodegradable products for cleaning your watercraft. Avoid environmentally harmful aerosol sprays, and dispose of used products and containers appropriately. Never place used oil and other chemicals (including soiled towels) in the trash, on the ground or down a drain. Contact your local or state office of public works to find out how to dispose of these wastes in your area.

# YOUR RESPONSIBILITIES

## Age Restrictions

This vehicle is not a toy. Polaris recommends that all operators be 16 years of age or older. Contact local authorities to find out what the legal age requirements are in your area of operation.

## Maintenance Requirements

Follow the recommended maintenance program outlined in your owner's manual. This preventive maintenance program is designed to ensure that all critical components on your vehicle are thoroughly inspected at specific intervals.

### **WARNING**

Failure to follow the warnings contained in this manual can result in severe injury or death. A Polaris watercraft is not a toy. It's a high performance powerboat and can be hazardous to operate. A collision or overturn can occur quickly if you fail to take proper precautions. Read and understand your owner's manual and all warnings before operating a Polaris watercraft.



# IDENTIFICATION NUMBERS

Your watercraft's hull and engine identification numbers are important for model identification when registering your watercraft, when obtaining insurance, and when ordering replacement parts. The hull identification number is located on the rear right-hand boarding platform (1). The engine identification number is located at the front of the engine near the stator cover (2).

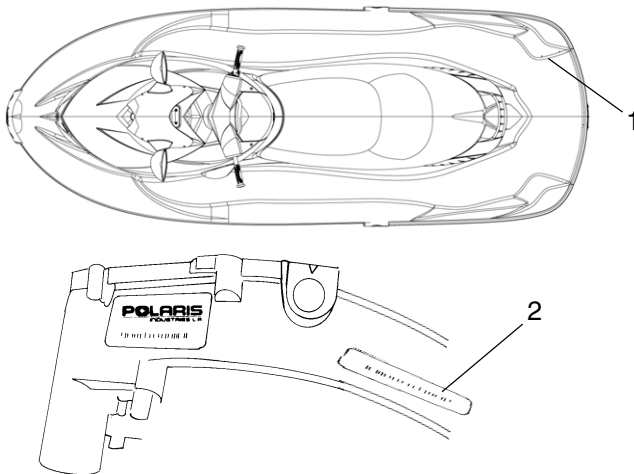

Record your vehicle's identification numbers in the spaces provided and in another location away from the vehicle. If the vehicle is destroyed or stolen, you'll have the identification numbers required by insurance and/or law enforcement.

**NOTE:** Check with your insurance agent about obtaining insurance coverage for your watercraft, or see your Polaris dealer.

Purchase Date:
----------------

Vehicle Model Number:
-----------------------

Engine ID Number:
-------------------

Hull ID Number:
-----------------

# SAFETY

## Signal Words and Symbols

The following signal words and symbols appear throughout this manual and on your vehicle. Your safety is involved when these words and symbols are used. Become familiar with their meanings before reading the manual.



The *safety alert symbol*, on your vehicle or in this manual, alerts you to the potential for personal injury.

### **WARNING**

The *safety alert warning* indicates a potential hazard that may result in serious injury or death.

### **CAUTION**

A *caution* indicates a situation that may result in damage to the vehicle.

### **NOTE:**

A *note* will alert you to important information or instructions.

### **CAUTION**

The *safety alert caution* indicates a potential hazard that may result in minor personal injury or damage to the vehicle.

## Safety Decals

Important warning and instruction decals have been placed on the watercraft for your protection. Read and follow the instructions on each decal carefully. If any decal becomes illegible or comes off, contact your Polaris dealer for a replacement. Any *safety* decal needing replacement will be provided by Polaris at no charge.

The warning decals summarize and highlight key safety and operational information. Be sure to read the entire owner's manual for details that affect safe operation of this watercraft.

# SAFETY

## Safety Decals

The general safety/warning decal is located on the rear of the watercraft, just below the seat.

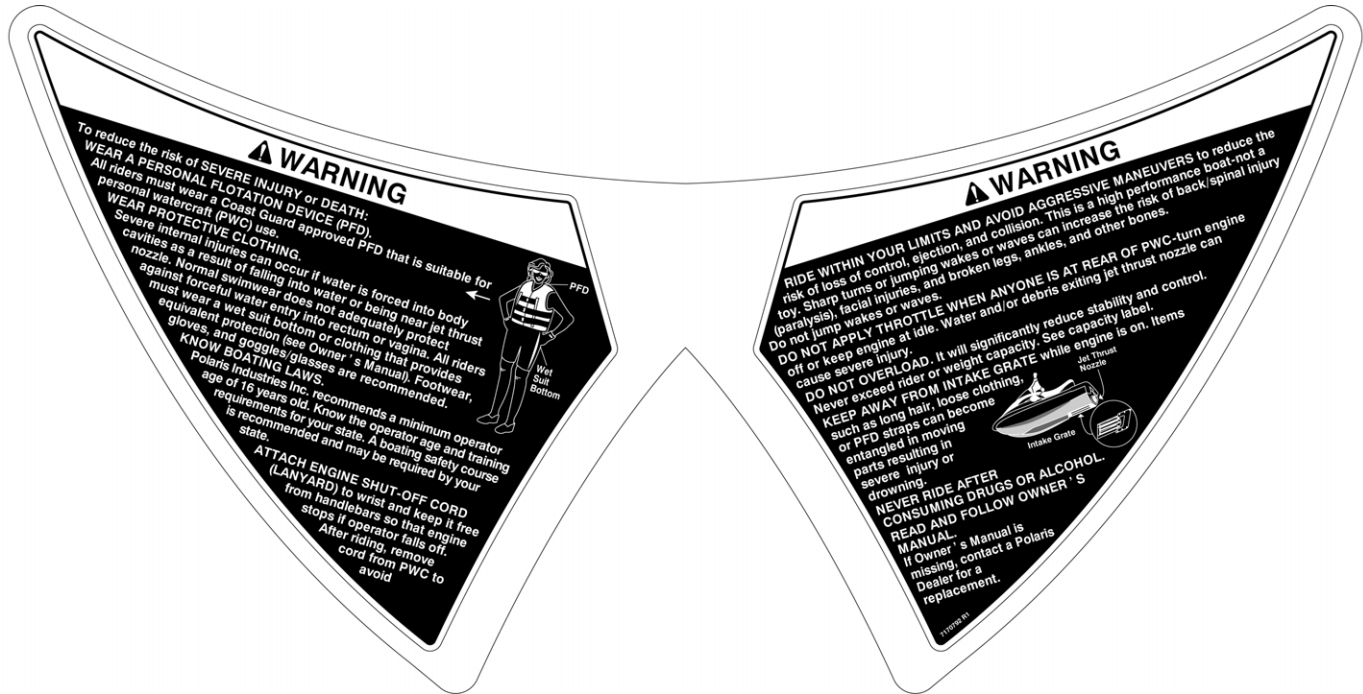

## Safety Decals

The collision warning decal is located on the dash of your watercraft.



# SAFETY

## Safety Decals

The fuel warning decal is located near the fuel tank fill cap.

The capsized warning decal is located at the rear of the watercraft, positioned upside down so the operator can read it when the boat is capsized.

**⚠ WARNING**



**RIGHTING CAPSIZED BOAT**

- To prevent injury, do not place hands or objects into pump inlet, intake grate or nozzle.
- To prevent major engine damage: Make sure engine is stopped by pulling lanyard from engine stop switch and turn boat to upright position in a clockwise direction.

7073865

**⚠ WARNING**

Gasoline and its vapors are highly flammable and explosive.

To avoid fire or explosion:

- Stop engine before refueling.
- Refuel in a well-ventilated area away from open flames or sparks.
- Do not overfill tank.
- Pull up seat and open engine compartment before starting engine. Push down and latch compartment cover and replace seat before restarting engine.
- Do not start engine if gasoline or vapors are present.

**CAUTION**

Every time you refuel, check engine oil. Running engine without oil will cause major engine damage.

7170790 R1

# SAFETY

## Informational Decals

The Coast Guard exemption decal is located below the left-hand mirror.



Located on the upper shroud near  
the front compartment door:

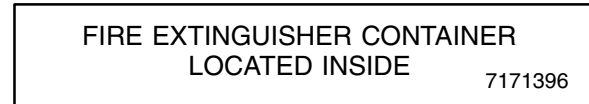

Located on the engine water manifold:

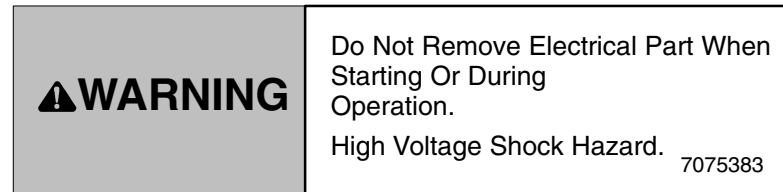

# SAFETY

## Operator Safety

### **WARNING**

Failure to follow the warnings and instructions contained throughout this manual and on your vehicle can result in severe injury or death.

Read and understand your owner's manual and all warning decals before operating a Polaris watercraft.

Any operator of a Polaris watercraft must know and practice the following guidelines for personal safety and the safety of passengers. Never permit a guest to operate this watercraft unless the guest has read and understands all warning decals and the owner's manual.

### **Operator Guidelines**

This watercraft is not a toy. It's a high performance powerboat, and operating it requires learned and practiced skills. All operators and passengers should become familiar with proper operating techniques before attempting maneuvers. Always operate the watercraft at a speed appropriate for water conditions and for your level of experience.

The minimum recommended age for operators of this watercraft is 16 years, but operators between 16 and 18 years of age may require close adult supervision. Obey all applicable boating rules and regulations.

*This watercraft does not have brakes.* The watercraft is stopped by releasing the throttle. The vehicle will glide to a stop due to the natural drag of the water. *Allow a minimum of 300 feet (90 m) to coast to a stop from full throttle.*

*Jet thrust is required to steer and turn the vehicle.* Never completely release the throttle and attempt to turn at more than a trolling speed. The watercraft will not turn. Practice until you're comfortable with turning and stopping, and be sure you've mastered the skills before carrying a passenger.

Learn and observe all local, state, and federal boating regulations and speed limits. Boating laws and navigational rules are designed for the safety of everyone sharing the waterways.



## Operator Safety

Your Polaris watercraft is capable of towing, but please be aware that towing can cause reduced steering control. Be extremely careful when towing other watercraft, skiers or objects behind this watercraft, as they have a significant impact on handling and steering. Observe local and state laws regarding water skiing and towing.

*Do not allow passengers to stand* on the boarding platform while the watercraft is running or in motion. Passengers should always remain seated.

*Never travel over a ski jump* or attempt to jump waves, wakes or other objects in the water. Doing so may severely damage the watercraft and cause personal injury due to the hard impact, a temporary loss of visibility, possible loss of control and reduced reaction time.

*Always securely attach the lanyard cord (1) to the operator's left wrist or PFD before starting the watercraft. If the operator falls off, the engine will immediately lose power.*

*Be sure the lanyard cord is free and not wrapped around the handlebars or controls. When the watercraft is not in service, disconnect the lanyard from the engine stop switch to prevent accidental starting of the engine.*

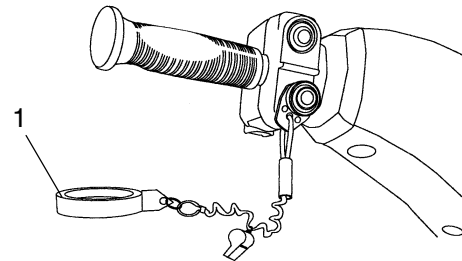

# SAFETY

## Operator Safety

### **▲WARNING**

Failure to wear protective clothing while operating a watercraft can result in serious injury. The jet pump emits a forceful stream of water that can injure body orifices. Falling off the watercraft while operating at higher speeds may also lead to injury. Always wear the recommended protective gear while riding on any watercraft.

### Safe Riding Gear

Always wear protective clothing when operating or riding a personal watercraft. Consider attaching a whistle to your lanyard to summon help in emergency situations.

#### 1 - Personal Floatation Device

The operator and passenger must always wear an approved personal flotation device (PFD) at all times to prevent accidental drowning. Polaris recommends a vest-type PFD (U.S. Coast Guard type 1, 2, or 3).

**NOTE:** The seat of the watercraft *is not* a PFD.

#### 2 - Eye Protection

Wear adequate eye protection to protect against water spray, sun, insects and other objects. To protect prescription eyewear and sunglasses against loss or damage, wear goggles that fit securely over them.

#### 3 - Suit/Shoes/Gloves

We recommend that all riders wear a wet/dry suit and watercraft shoes to protect against the force of the water, as well as exposure and unknown hazards in the water, such as debris and hidden objects. Riding gloves may also be considered.

**NOTE:** A helmet may provide increased personal injury protection in some situations, such as impact with the watercraft or during a collision with other watercraft or an obstacle. However, a helmet may not provide adequate protection against all foreseeable impacts and may aggravate some injuries. For example, if a rider falls off a moving watercraft while wearing a helmet, the helmet could catch the water and cause choking, severe and permanent injuries or death. A helmet may also increase the possibility of an accident if it reduces your visibility or ability to hear or if its weight contributes to fatigue.

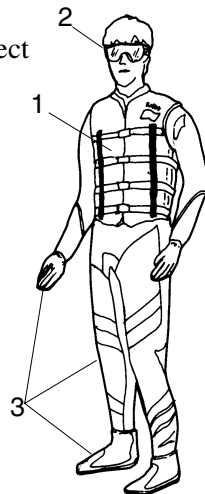

## Operator Safety Overloading the Watercraft

### **⚠️ WARNING**

Overloading a watercraft will significantly reduce vehicle stability and control, which could result in an accident and lead to severe injury or death. Never allow more than the specified rider capacity on the watercraft.

Polaris watercraft are designed to carry an operator and up to three passengers, depending on the model. Check the specifications section beginning on page 102 to determine your boat's rider capacity.

When more than one person is riding, the watercraft handles differently, which means that the operator must have enough prior riding experience to handle the watercraft with one or more passengers aboard.



## Fire Safety

Federal regulation requires that all watercraft carry an approved fire extinguisher. The operator is responsible for providing and maintaining the fully charged fire extinguisher in the watercraft. Do not operate the watercraft without a fire extinguisher on board.



Stow your fire extinguisher under the front storage compartment in the cut-out area of the flotation foam. Know how to reach the extinguisher quickly in case of fire, and know how to use it before you operate the personal watercraft.

If you have any doubts about your ability to extinguish a fire, swim away from the craft as quickly as possible. Immediately seek help from other boaters or people on shore.

# SAFETY

## Operator Safety Weather and Darkness

Be aware of severe weather conditions. Observe weather forecasts and conditions before venturing out, and do not operate the watercraft when visibility is poor and when the water is rough. Operation of the watercraft in poor weather conditions can result in an accident and lead to severe injury, hypothermia or death.

Never operate the watercraft after sunset, before sunrise or in any condition of darkness. The vehicle is not equipped with lights, which makes it unsafe and illegal to operate in darkness. Consult local regulations concerning allowed hours of operation.

Always ride with another watercraft when operating in remote areas or in large areas of open water. Carry a flare gun on board to signal for help if necessary.

## Protective Apparel

Normal swimming attire may not provide adequate protection while riding a watercraft. At the rear of the watercraft, the jet pump emits a forceful stream of water that can injure body orifices, such as mouth, eyes, ears, rectum and vagina. In addition, falling off the watercraft while operating at higher speeds may lead to injury due to impact with the water. All riders must wear wet suit bottoms or clothing that provides equivalent protection.

**NOTE:** If a passenger falls from the watercraft, release the throttle immediately. Do not exceed idle speed if any person is within 50 feet (15 m) of the rear of the watercraft.



## Operator Safety Obstacles and Shallow Water

Always be on the lookout for dangerous obstacles above and below the water surface, especially in shallow water. Use extra caution when riding in unfamiliar areas.

Never ride in water that is less than two feet (60 cm) deep, and do not operate at more than an idle speed in water that is less than six feet deep. Colliding with an underwater object could result in severe injury or death. Ingesting sand into the cooling system will also cause the engine to overheat, which could lead to serious mechanical damage.

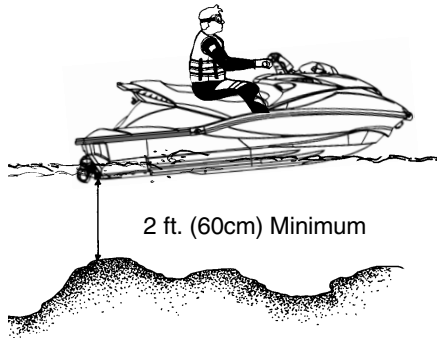

If the watercraft has been beached or has been sitting in shallow water, clear out any sand or small rocks before boarding and restarting the watercraft. Remove the particles by bouncing the back of the machine up and down in at least two feet of water. If the craft has been beached, flush the cooling system.

## CAUTION

Failure to flush the cooling system after the watercraft has been beached could result in serious engine damage. Always follow the recommended flushing procedures and flush the cooling system any time the watercraft has been beached.

# SAFETY

## Operator Safety Turning and Accelerating

Turning and accelerating without checking for other boats and objects in your path can cause an accident and result in severe injury or death. *Always look behind the watercraft and to each side before accelerating and before making sudden turns.* Always be aware of obstacles, swimmers and other watercraft.

Quick turns or abrupt changes in speed can cause passengers to lose their balance and be ejected from the vehicle, which could result in injury. The operator should always alert any passengers before making sudden turns or changes in speed.

## Pre-Operation Check

Always perform the pre-operation check (beginning on page 38) before starting and riding the watercraft. Make sure all critical components are operating correctly. Check fuel and oil levels and all controls, especially the throttle lever, handlebars, and steering nozzle. Failure of these critical components can result in an accident and lead to severe injury or death.

## Service and Maintenance

Routine service and adjustments to the watercraft are critical for the safe operation and extended life of the watercraft. Follow the maintenance and service recommendations outlined in this manual.

## Operator Safety

### Jet Pump Water Intake Safety

Contact with the jet pump or driveline components of the watercraft can result in severe injury, death or drowning. Do not allow hands, feet, ropes, straps, clothing or long hair to come in contact with the jet pump water intake (1) on the bottom of the watercraft while the engine is running.

Never insert any object into the intake or outlet (2) of the jet pump, and never start or operate the watercraft with the inlet grate, ride plate (3), or any guards or shields removed.

To prevent serious injury due to accidental starter engagement, be sure the engine is off and the safety lanyard is disconnected before removing weeds or debris that may have collected in or around the jet pump intake.

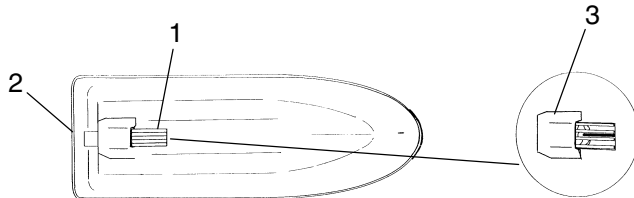

### Electrical Shock Hazard

Never touch or remove electrical parts while starting or during operation of the watercraft. Severe injury or death could result from electrical shock.

### Safe Riding Position

Falling off a watercraft can result in serious injury. The operator and any passengers should always keep both feet firmly planted on the floorboards while the watercraft is in motion. The passenger should face forward and firmly hang on to the operator's waist, except in towing situations, when the spotter faces the rear and uses the grab handle to hold on.

### Lifting the Watercraft

Severe back injury or other injury could result from attempting to lift the watercraft without assistance. Never attempt to lift the watercraft without the aid of a trailer and winch or another heavy lifting device.

# SAFETY

## Operator Safety Operator Awareness

A collision can cause severe injury or death. Always be aware of other watercraft, swimmers and other obstacles while operating the watercraft. Always maintain a safe distance, especially if you're an inexperienced operator. Do not exceed idle speed if any person is within 50 feet (15 m) of the rear of the watercraft.

## Operator Fitness

Safe operation of this rider-active craft requires good judgement and physical skills. Persons with cognitive or physical disabilities who operate this vehicle have an increased risk of overturns and loss of control, which could result in serious injury or death.

Riding personal watercraft is strenuous. All riders should be in good physical condition. Pregnant women should consult their physicians before riding any watercraft.

Reboarding the watercraft in deep water can also be strenuous. Operators and passengers should be physically fit enough to reboard the watercraft in deep water. Practice boarding in chest-deep water to be sure you are physically able to reboard if the need arises.

## Boating Under the Influence

Operating any watercraft while under the influence of alcohol or drugs could result in an accident and lead to severe injury or death.

More than half of all the people who drown have consumed alcohol prior to their accident. Even if you're not intoxicated, any amount of alcohol can be a threat to your safety and the safety of others. The equivalent of one beer will impair your balance, vision, judgment and reaction time, making you a potential danger to yourself and others.

Do not operate any watercraft while under the influence of alcohol or drugs.





## Operator Safety Vehicle Modifications

Modifications to this machine could create safety hazards and reduce vehicle reliability as well as make it unsafe or illegal to operate. *Do not modify this watercraft or any of its components.* Any modifications to the watercraft will void your warranty.

## Operator Fatigue and Dehydration

Long hours of boating with exposure to noise, vibration, sun, glare and wind can result in operator fatigue and dehydration. These conditions can affect your balance, vision, judgment and reaction time.

Fatigue and dehydration can increase your risk of an accident resulting in bodily injury or death. Combining alcohol consumption with this condition greatly increases your risk of causing an accident.

Learn to recognize the early symptoms of fatigue, and allow your body to recover by taking a break from operating the watercraft. Drink plenty of non-alcoholic beverages to prevent dehydration, and wear protective riding gear to protect against exposure to weather elements.

## Hypothermia

Your life may depend on a clear understanding of the effects of cold water on the human body. Many suspected drowning victims actually died from cold exposure (hypothermia) rather than drowning.

Hypothermia can begin in water as warm as 80° F. (27° C). It's a condition in which the body loses heat faster than it can produce it. Violent shivering develops, which may give way to confusion and a loss of body movement. Hypothermia can result in severe injury or death in a very short time.

### To avoid hypothermia:

- Dress warmly.
- Wear proper gear and stay as dry as possible.
- Seek a warm environment at the first sign of hypothermia (mild shivering).

### If you fall into the water:

- Do not discard clothing.
- While wearing your life jacket, draw your knees up toward your chest and hold them there with your arms in the Heat Escape Lessening Posture (HELP).

## FEATURES AND CONTROLS

1. **Starter Button** - Depress and hold the starter button to start the engine. Release it as soon as the engine starts. Do not depress for more than ten seconds at a time. **NOTE:** The lanyard and lock plate must be attached to the engine stop switch to start the engine
2. **Stop Switch/Lanyard** - Push this switch down or disconnect the lanyard plate to stop the engine quickly.
3. **Safety Lanyard Wrist Cord** - The lock plate end is attached to the stop switch. The wrist band is attached to the operator's wrist or PFD. The engine will not start unless both are attached.
4. **Gauge Mode Button** - This button operates the display change for the NGI. See page 30.
5. **Throttle** - Squeeze the throttle lever toward the handlebar to increase speed. Release the lever to slow the craft and return the engine to idle. **NOTE:** The throttle lever installed on your MSX is finger-operated, but Polaris also offers an accessory thumb-operated lever. See your Polaris dealer for more information.
6. **Instrumentation** - Instrumentation is New Generation Instrument (NGI). See page 30 for a detailed explanation of the NGI display.
7. **Seat Latch** - The seat latch secures the seat in position. When released, it provides access to the engine compartment.

8. **Jet Pump Outlet Nozzle** - The nozzle is the exit for the jet output. Orientation is controlled by the handlebars and determines the direction of craft movement.
9. **Exhaust Outlet**
10. **Reverse Gate**
11. **Drain Plugs** - When water gets into the bilge, it can be drained through the drain plugs. Remove the watercraft from the water before draining the bilge. Be sure the plugs are securely installed before launching the craft.
12. **Fuel Tank Fill** - The fuel fill is located under the front compartment door. Turn the cap counterclockwise to remove, clockwise to replace.
13. **Oil Fill** - The oil fill is located under the front compartment door. Turn the cap counterclockwise to remove, clockwise to replace.
14. **Jet Pump Intake Grate** - The grate protects the impeller and drive shaft and protects riders from contact with components.
15. **Drive Shaft** - Beneath the intake grate, the drive shaft transmits power from the engine to the impeller.
16. **Ride Plate** - The ride plate covers and protects the jet pump and provides leveling control for the craft.

# FEATURES AND CONTROLS

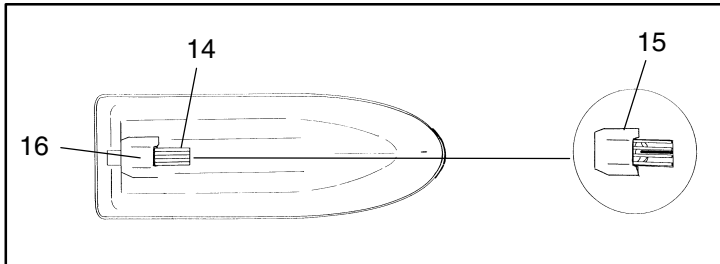
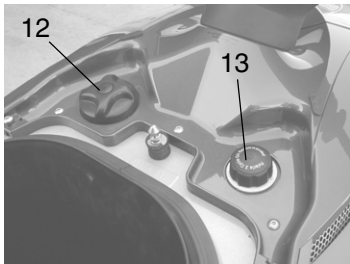
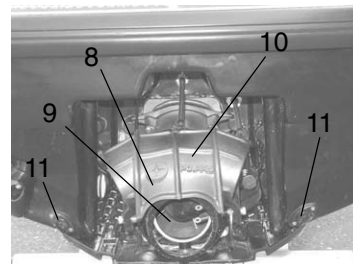
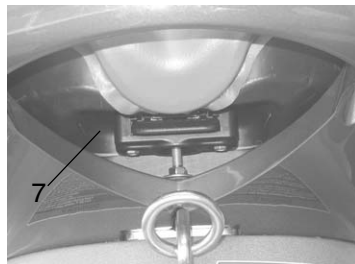
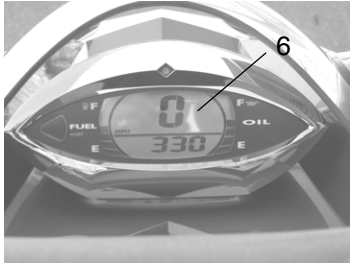
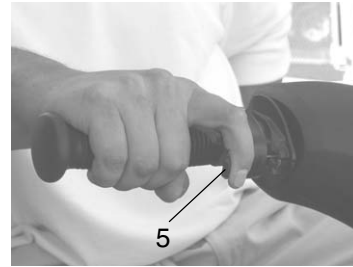
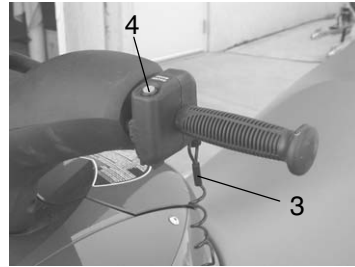
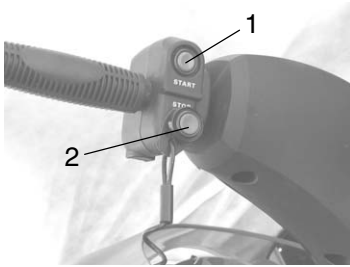

## FEATURES AND CONTROLS

1. **Front Compartment Door**- The door provides access to the fire extinguisher, oil tank, fuel fill, oil fill and main storage space.
2. **Fire Extinguisher Compartment** - Located under the front compartment door and under the storage bucket in the left side flotation foam, this compartment provides secure storage for the fire extinguisher.
3. **Handlebars** - The handlebars control the orientation of the jet pump outlet nozzle, which in turn controls the direction of craft movement.
4. **Console Storage**
5. **Seat/Engine Compartment** - Removing the seat provides access to the engine, battery, electrical box, exhaust system, and other components.
6. **Grab Handle** - The grab handle assists riders while boarding the craft or when riding as passengers.
7. **Tow Eye/Hook** - Securely attach the tow rope to this hook when pulling skiers, wake boarders and tubes.
8. **Boarding Platform/Footwell Pads** - The boarding platform assists riders while boarding. The footwell pads are the place for the operator's and passenger's feet while riding the watercraft.
9. **Sponson** -The sponson enhances vehicle stability and turning ability in water.
10. **Reverse Operation Handle**

# FEATURES AND CONTROLS

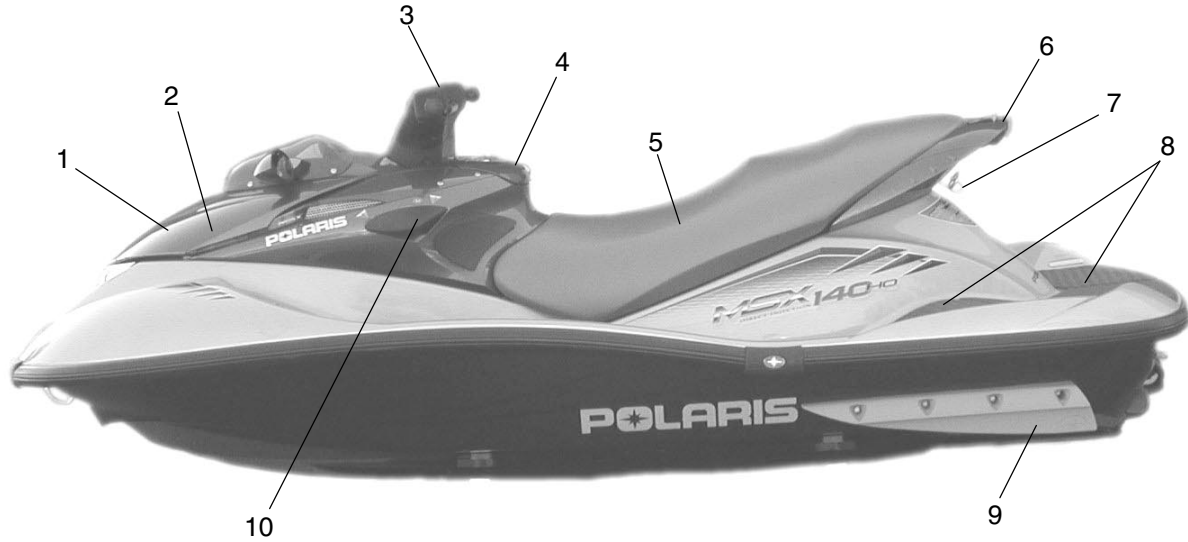

# FEATURES AND CONTROLS

## Engine Components (under seat)

1. Battery
2. Engine Management Module (EMM)
3. Spark plugs
4. Air intake cover
5. Starter solenoid
6. Exhaust silencer
7. Exhaust pipe
8. Exhaust cooling water hose
9. Cooling water manifold
10. Thermostat assembly (under end of water manifold)
11. Spark arrestor/air filter
12. Engine cooling water outlet hose (under thermostat assembly)

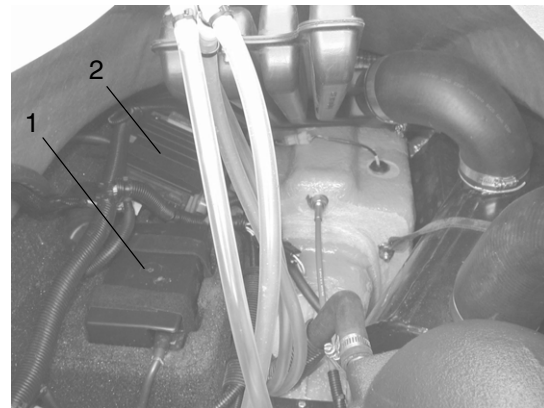

# FEATURES AND CONTROLS

## Engine Components

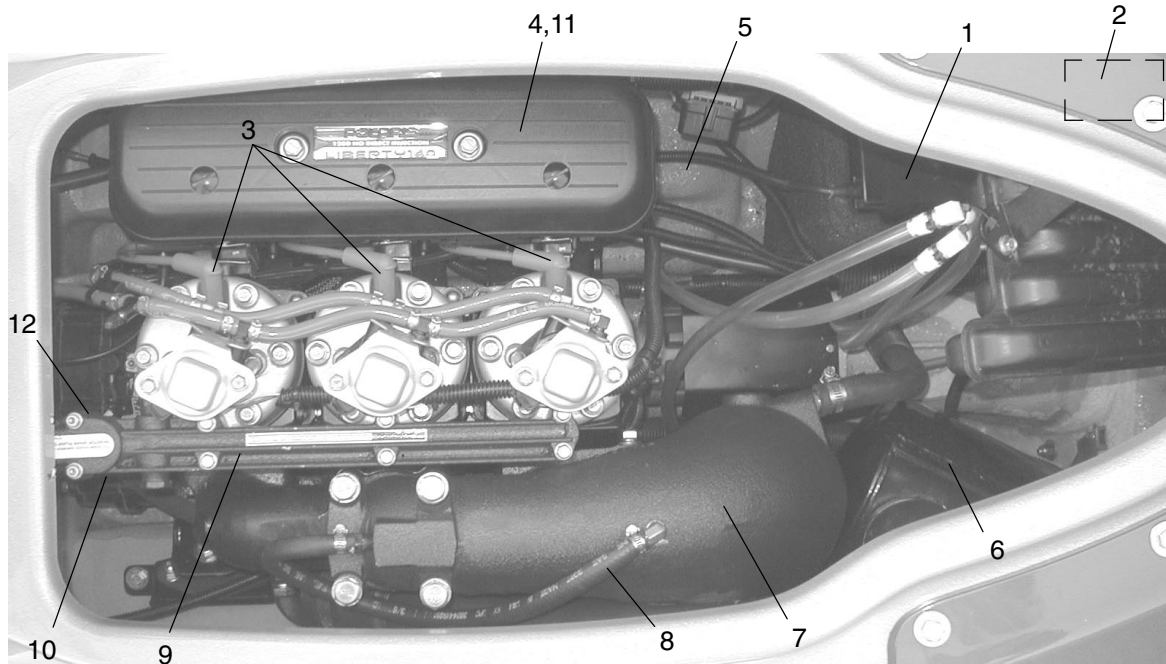

# FEATURES AND CONTROLS

## New Generation Instrument (NGI)

### Primary Functions

- Speedometer
- Clock
- Tachometer
- Engine Hourmeter
- Trip Odometer
- Oil Level
- Fuel Level
- Low Oil/Pressure/Fuel/  
Battery Voltage Warnings
- High Engine Temperature Warning
- Check Engine Warning



### Accessible Functions

- Tachometer
- Engine Hourmeter
- Trip Odometer



# FEATURES AND CONTROLS

## New Generation Instrument (NGI)

### Function Overview

#### Speedometer

The large numeric speedometer displays vehicle speed. The NGI receives signals via a paddle wheel located on the ride plate. The gauge interprets these signals and computes actual vehicle speed.

#### Tachometer

The NGI has the ability to display between 0 and 9950 RPM. The gauge receives the tachometer signal from the EMM. Display tolerance is  $\pm 100$  RPM.

#### Oil Level

Oil level is displayed with a 7-bar LCD graphic. Oil levels are displayed in 1/7th increments. When the display is 1/7th (one bar), a LOW OIL symbol and red LED warning light will blink to alert the operator to the low oil condition. Refill the oil tank.

### CAUTION

Operating the engine without oil will result in serious engine damage. Always add oil when the level is low.

#### Fuel Level

Fuel level is displayed with an 8-bar LCD graphic. The level is displayed in 1/8th increments. When the display is 1/8th (one bar) or less, a LOW FUEL symbol and red LED warning light will blink to alert the operator to the low fuel condition. Refill the fuel tank.

#### Engine Hourmeter

The NGI retains and displays up to 999.9 hours. Additional hours will not reset the gauge to zero. The gauge begins to record engine hours whenever the engine RPM is 500 RPM or higher. Memory retention is approximately 10 years.

#### Clock

The NGI displays the time in the main display mode without reference to either AM or PM.

#### Trip Odometer

The NGI will display accumulated miles or kilometers traveled. Engine RPM must be at or above 500 before the gauge will begin recording the distance traveled.

# FEATURES AND CONTROLS

## New Generation Instrument (NGI)

### Instrument Operation

#### DISPLAY MODE

There are three different display modes the gauge uses to display information to the operator. The three modes are: MAIN MODE, SPEED/TACHOMETER MODE and NAVIGATION MODE. Press and release the MODE button on the left handlebar control to advance through the three modes.

**MAIN MODE** displays SPEED and CLOCK.

**SPEED/TACHOMETER MODE** displays SPEED and TACHOMETER.

**NAVIGATION MODE** displays SPEED, TRIP ODOMETER and ENGINE HOURS.

#### CLOCK SET

In the main mode, press and hold the RESET button until the hour digits flash (approximately six seconds). Press the RESET button to advance the hour digits. Press the MODE button to stop the hour flash and begin the minute digits flash. Press the RESET button to advance one minute. Press the MODE button to set the clock and exit the clock set mode.

#### TRIP ODOMETER RESET

Press and hold the RESET button until the trip odometer is reset to 000.0 miles / km.

#### CHANGE UNITS OF MEASURE

To toggle between English and metric units of measure, press and hold the MODE button for ten seconds.

## New Generation Instrument (NGI)

### Display Warnings

The NGI will alert the operator to the following conditions:

- **LOW FUEL** (Fuel level reaches 1/8 level.)
- **LOW OIL** (Oil level reaches 1/7 level.)
- **LOW BATTERY VOLTAGE**  
(Battery voltage is at or below 10.9 vDC)
- **HIGH TEMPERATURE**  
(Temperature is monitored by EMM)
- **CHECK ENGINE**  
(Check engine warning is triggered by EMM)

Regardless of warning, each warning will display a related ISO symbol on the screen and a blinking red LED warning.

# FEATURES AND CONTROLS

## RPM Limiter

### CAUTION

A clogged intake and/or impeller can cause engine overheating and/or damage to the jet pump and impeller parts. Always keep the intake and/or impeller free of debris and weeds.

Your Polaris watercraft is equipped with a device that will limit engine revolutions per minute (RPM) if the engine overheats. This feature is designed to help prevent engine damage caused by engine overheating.

If the high temperature indicator and warning displays, stop the engine *immediately*.

Clean the jet pump and impeller as outlined on page 24. If the cause of overheating is identified and corrected, normal operation can be resumed by releasing and reapplying the throttle.

If the engine continues to overheat after cleaning the jet pump and impeller, take the watercraft to an authorized Polaris dealer for service.

# FEATURES AND CONTROLS

## Standard Equipment

- Watercraft Owner's Safety and Maintenance Manual
- Watercraft Safety Video PN 9916475
- Lanyard with wristband, lock plate and whistle
- Tool Kit containing: wrench, flat screwdriver, Allen wrench, spark plug wrench with Phillips head screwdriver

Contact an authorized Polaris dealer for replacement parts and equipment. Provide part numbers when possible.

## Accessories

Polaris has a wide range of watercraft accessories, from wetsuits and life vests to accessory mirrors, touring and towing gear, and performance parts. Contact your Polaris dealer or visit [www.polarisindustries.com](http://www.polarisindustries.com) to see our full line of available products.

## Optional Equipment

See page 101 for a list of Polaris products for servicing your watercraft.

- U.S. Coast Guard-approved fire extinguisher (UL 5-B:C Rating) PN 2871012
- Registration numbers (see your Polaris watercraft dealer)
- Tow rope (for emergency use) PN 2871310
- Flare gun (for emergency use) PN 2871533
- Safety and riding gear, including approved personal flotation devices for operator and passenger (see your Polaris watercraft dealer)

# EMISSIONS

## EPA Emissions Regulations

All direct injection equipped engines manufactured by Polaris Industries are certified to the United States Environmental Protection Agency regulations for the control of air pollution. For this reason, factory procedures for servicing must be strictly followed, and wherever practicable, returned to the original intent of the design.

Maintenance, replacement, or repair of the emission control devices and systems may be performed by any marine SI engine repair establishment or individual.

Refer to the California Emission Control System Limited Warranty beginning on page 107.

## California Star Labels

A star label has been applied to your personal watercraft in accordance with the requirements of the California Air Resources Board. The star label means *cleaner marine engines*.

**Cleaner Air and Water** - for healthier lifestyle and environment.

**Better Fuel Economy** - burns up to 30-40 percent less gas and oil than conventional carbureted two-stroke engines, saving money and resources.

**Longer Emission Warranty** - protects consumer for worry free operation.

The **MSX 140 HO** engine has been certified as:

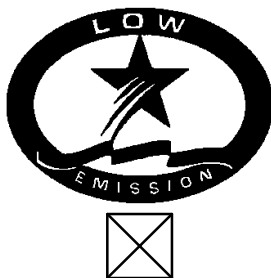

## California Star Labels

### One Star - Low Emission



The one-star label identifies engines that meet the Air Resources Board's 2001 exhaust emission standards. Engines meeting these standards have 75% lower emissions than conventional carbureted two-stroke engines. These engines are equivalent to the U.S. EPA's 2006 standards for marine engines.

### Two Stars - Very Low Emission



The two-star label identifies engines that meet the Air Resources Board's 2004 exhaust emission standards. Engines meeting these standards have 20% lower emissions than One Star - Low Emission engines.

### Three Stars - Ultra Low Emission



The three-star label identifies engines that meet the Air Resources Board's 2008 exhaust emission standards. Engines meeting these standards have 65% lower emissions than One Star - Low Emission engines.

# OPERATION

## Pre-Operation Inspection

Use the Pre-Operation checklist beginning on page 39 to verify that your vehicle is in proper operating condition before each use. Procedures are outlined in further detail on the pages following the checklist.

### WARNING

If a proper inspection is not performed before each use, severe injury or death could result. Always inspect the vehicle as outlined in the checklist before each use to ensure it's in proper and safe operating condition. See page 75 for additional inspection information. Always remove the lanyard from the engine stop switch before performing the pre-operation inspection.

### WARNING

Starting or operating the watercraft with a fuel leak can result in an explosion, causing serious injury or death. If you smell fuel in the hull of the craft, *do not start the vehicle*. Take it to your dealer immediately for inspection.



## Pre-Operation Inspection

Item	What To Do
Bilge	Drain water from the bilge before putting the craft in the water.
Fuel/oil tank levels	Check fuel/oil; add as necessary; inspect for presence of water.
Jet pump water intake	Inspect and remove any debris; ensure intake grate is secure; push rear of craft up and down in the water to flush sand out of water intake before starting.
Throttle	Check for proper operation.
Steering	Check for proper operation; inspect control cable.
Fire extinguisher	Inspect condition/expiration date.
Storage compartment	Check and secure latches.
Engine cover (seat)	Remove and ventilate engine compartment before starting engine. Re-secure latches.

Item	What To Do
Battery	Check fluid level/condition; vent hose must be clear and open.
Hull	Inspect hull for damage or cracks; clean off any marine growth.
Drain plugs/bilge	Inspect; clean; be sure each plug is tight, secure and doesn't leak.
Loose parts/hoses	Inspect for loose parts/hoses and connections; tighten as needed.
Seat	Check and secure latches.
Loose ropes/straps/clothing/long hair	Be sure that there are no loose ropes, straps, clothing, etc.; Long hair is tied back and secured.
Riding gear	Check operator and passenger for complete gear and proper fit.
Switches/buttons	Check for proper operation.
Lanyard cord/stop switch	Check condition and operation.
Reverse System	Check for proper operation.

# OPERATION

## Pre-Operation Inspection Fuel

### **WARNING**

The engine exhaust from this product contains chemicals known to cause cancer, birth defects or other reproductive harm.

Operate this vehicle only outdoors or in well-ventilated areas.

### **WARNING**

Gasoline is highly flammable and explosive under certain conditions. Always heed the following warnings pertaining to gasoline and fumes.

- Always remove the seat and ventilate the engine compartment before starting the engine.
- Always check for fumes prior to starting engine.
- Always exercise extreme caution whenever handling gasoline.
- Always refuel with the engine stopped and outdoors or in a well ventilated area.
- Do not smoke or allow open flames or sparks in or near the area where refueling is performed or where gasoline is stored.
- Do not overfill the tank. Do not fill the tank neck.
- If gasoline spills on your skin or clothing, immediately wash it off with soap and water and change clothing.
- Never start the engine or let it run in an enclosed area. Gasoline powered engine exhaust fumes are poisonous and can cause loss of consciousness and death in a short time.

## Pre-Operation Inspection Fuel

### CAUTION

Using a non-recommended fuel may cause serious engine damage. Polaris recommends the use of 87 octane (or higher) non-oxygenated or 89 octane (or higher) oxygenated fuel only.

Your watercraft features an oil injection system, and it's not necessary to pre-mix the gasoline and oil. Refer to the specifications section beginning on page 102 for the proper fuel octane and oil requirements for your Polaris watercraft.

### WARNING

Failure to follow proper refueling instructions can result in fire or explosion, causing severe injury or death.

Always stop the engine and disconnect the lanyard from the engine stop switch before refueling.

## Refueling

Carefully remove the fuel cap.

**NOTE:** Keep the watercraft horizontal while fueling.

The use of a funnel or flexible spout will help avoid gasoline spillage on the watercraft. Always wipe up any spills immediately. Wash out the footwells with water if fuel or oil spills in those areas.

Use fresh, seasonal gasoline that has been stored in a clean container. For the best performance from gasoline, purchase only what is needed for a month or less of operation.

**NOTE:** If the fuel or oil levels become low, a warning light will flash on the NGI display. Proceed to shore and refuel.

# OPERATION

## Pre-Operation Inspection Oil

### CAUTION

Mixing brands or using a non-recommended oil may cause serious engine damage. We recommend the use of Polaris synthetic 2-cycle oils. Never mix oil brands.

The oil fill cap (1) is located under the front compartment door. Check the oil level before each use of the vehicle and add oil as necessary. Make sure the engine is off and the safety lanyard is removed from the engine stop switch before adding oil.

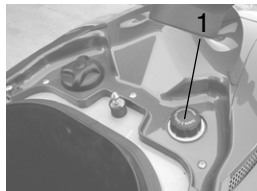

Polaris synthetic 2-cycle oils are formulated to work with your watercraft engine. They've been thoroughly tested to provide the ultimate in performance and protection. Our biodegradable synthetic 2-cycle oil is also environmentally friendly. See page 101 for part numbers of Polaris products.

1. Place the watercraft in a level position.
2. Remove the oil fill cap and check the oil level.
3. Add the recommended oil. Fill to within several inches of the fill hole opening. **NOTE:** Do not fill all the way to the opening. Wipe up any spills immediately.
4. Visually inspect the oil for water or foreign matter. If either is present, see your Polaris dealer for service.

A warning light on the NGI display will flash if oil is low (1/8 tank or less). Add oil promptly.

### CAUTION

If the engine is operated without oil, severe damage will occur. If you discover an empty oil tank, see an authorized Polaris dealer immediately for service.

Severe engine damage will occur if water becomes mixed into the oil. Always tighten the oil fill cap securely.

## Pre-Operation Inspection Jet Pump Intake

1. Ride Plate
2. Impeller
3. Drive Shaft
4. Intake Grate

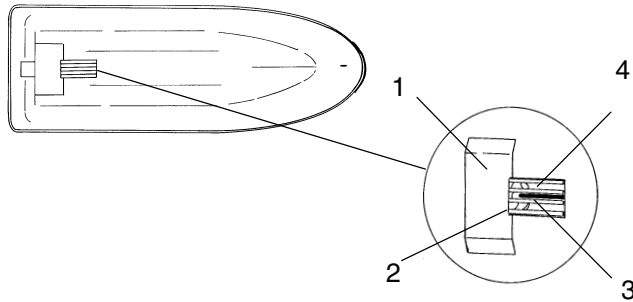

### **⚠ WARNING**

Improperly connecting or disconnecting battery cables can result in an explosion and cause serious injury or death. When disconnecting cables, always disconnect the negative (black) cable first. When reconnecting, always connect the negative (black) cable last.

1. Remove the lanyard lock plate from the stop switch and disconnect the battery cables before inspecting the jet pump intake. Disconnect the negative (black) cable first.
2. Carefully check the jet pump intake and remove any weeds, shells or other debris that may restrict the intake of water.
3. After launching, walk the watercraft into water at least two feet (60 cm) deep and bounce the back of the craft up and down several times to flush out any sand and debris that may be in the pump.

### **CAUTION**

A clogged intake or the ingestion of sand into the cooling system will cause engine overheating and result in jet pump or engine damage. If any obstruction cannot be removed, have an authorized Polaris dealer service it immediately. Clear the pump of sand after operating in shallow water or after beaching the watercraft.

# OPERATION

## Pre-Operation Inspection

### Steering

Check the handlebars for free movement throughout their full range. Make sure the jet pump outlet nozzle changes direction as the handlebars are turned from left to right and vice versa.

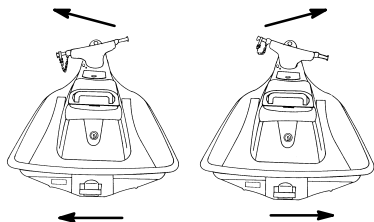

Be sure the handlebars and handlebar grips fit snugly. Visually inspect the control cable to ensure that it's in working condition.

### Throttle

Always check throttle operation prior to starting the engine.

Pull or squeeze the throttle several times to be sure the throttle lever moves freely through its full range. It should spring back to its original position when released.



### Engine and Storage Compartments

If the craft is operated in salt water, spray the inside of the hull (engine and components) with waterproof lubricant spray after every use. See page 101 for part numbers of Polaris products.

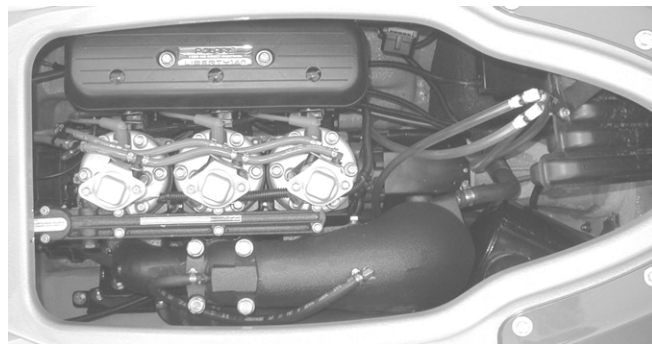

The engine compartment is located beneath the seat.

Be sure the seat, engine cover and front compartment door are properly positioned and securely latched before operating the watercraft.

## Pre-Operation Inspection Loose Parts

Inspect the watercraft for any loose nuts, bolts, fasteners and hoses. Be sure that all hose clamps are tight. Replace cracked or deteriorating hoses.

## Seat

To access the engine/storage compartment, disengage the rear seat latch (1). Always remove the seat and ventilate the engine compartment before starting the engine. Be sure all seats are properly positioned and secure before operating the watercraft.

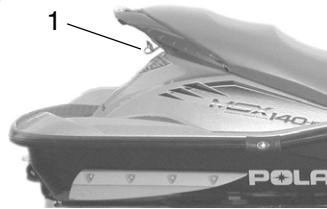

**NOTE:** The seat is not a personal flotation device (PFD) and will not provide life-saving flotation. Always wear a PFD when operating or riding a watercraft.

## Fire Extinguisher

The operator of the watercraft is required by law to carry a fire extinguisher on board. Always keep a fully charged and working fire extinguisher inside the fire extinguisher holder, which is located inside the storage area under the front compartment door.



A fire extinguisher is not standard equipment with this watercraft. Contact your Polaris dealer or a fire extinguisher dealer to purchase a U.S. Coast Guard-approved fire extinguisher with a UL 5-B:C rating.

# OPERATION

## Pre-Operation Inspection Battery

### **⚠ WARNING**

Causing sparks while servicing the battery or servicing the battery when gas fumes are present can result in an explosion, causing serious injury or death.

Never create a spark while servicing the battery. If you smell fuel in the craft, *do not service the battery*. Take the watercraft to your dealer immediately for inspection.

Confirm that the battery terminal connections are tight, and make sure the battery is securely fastened in its mounting position. Inspect the battery for leaks, and check the vent hose for kinks or blockage.

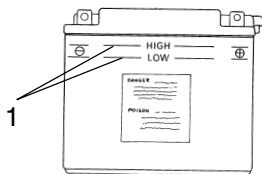

Check the battery fluid level and add only distilled water if the level is low. Tap water contains minerals that are harmful to a battery. Maintain the fluid level between the upper and lower marks (1) on the battery.

Keep the battery in good condition and fully charged at all times, as a weak battery can leave you stranded. Never operate the watercraft with a battery that's too weak to start the engine or shows signs of loss of power.

Use a trickle charger to maintain the battery's charge during the off season. Doing so will ensure a good battery at the end of the storage period and a longer life for the battery.

**NOTE:** The Polaris Battery Tender™ battery charger can be left connected during the storage period and will automatically charge the battery if the voltage drops below a pre-determined point. See your dealer or visit our online store at [www.purepolaris.com](http://www.purepolaris.com).



## Pre-Operation Inspection Hull

Use a non-abrasive cleaner to remove any marine growth and inspect the hull for cracks or damage. Do not operate the watercraft if the hull is damaged.

### Drain Plugs and Bilge

Turn each bilge drain plug (1) counterclockwise and remove it. Clean the plug and plug hole of any sand and debris before reinstalling. Do not operate the watercraft if any drain plug is loose or missing.

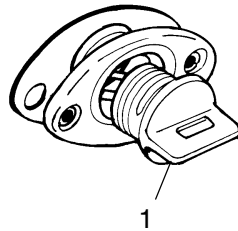

When the watercraft is out of the water, remove the drain plugs and carefully flush out the bilge with fresh water. Allow the bilge to drain completely. Wipe out the bilge with dry shop towels and reinstall the drain plugs. After launching the craft, remove the seat and check for leaks.

## Riding Gear

Be sure all operators and passengers have the appropriate riding gear, including a PFD (see page 16). Make sure all trailing objects are securely tied back or stowed.

### **⚠ WARNING**

Objects trailing from a person in the water or from the watercraft can easily become entangled in the jet pump impeller and cause severe injury or death. Make sure long hair, straps, ropes, clothing and similar objects are tied back and secured.

# OPERATION

## Pre-Operation Inspection

### Switches/Buttons

Perform these checks while the watercraft is in the water:

1. Check the inside of the engine compartment for fuel or water leaks. Do not operate the watercraft until any leaks have been repaired and the engine compartment has been ventilated.
2. Start the engine and let it run for a few seconds. Remove the lanyard lock plate (1) from the engine stop switch (2) to test operation. The engine should stop immediately. If it doesn't, press the stop switch to stop the engine. Do not ride the watercraft. See your Polaris dealer for service before operating the watercraft.

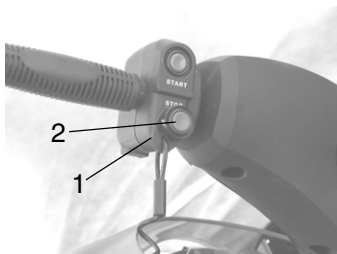

3. If removing the lanyard lock plate successfully stopped the engine in the previous step, start the engine again and allow it to run for a few seconds. Depress the engine stop button. If the engine doesn't stop immediately, remove the lanyard lock plate to stop the engine. Do not ride the watercraft. See your Polaris dealer for service before operating the watercraft.

## Principles of Operation

The engine is directly coupled to a driveshaft. When running, the driveshaft rotates the impeller. The impeller is positioned so that water is drawn up from beneath the watercraft. The water travels through the impeller and is accelerated, producing thrust to move the watercraft forward. Pulling or squeezing the throttle lever increases engine speed (watercraft speed).

Turning the handlebar pivots the jet pump nozzle (water outlet) which controls the watercraft's direction. The throttle must be applied in order to turn the watercraft.

## Engine Break-in Procedure

The break-in period for your new Polaris watercraft is defined as the time it takes to use the first full tank of gasoline. No single action on your part is as important as following the procedures for a proper break-in. Careful treatment of a new engine will result in more efficient performance and longer life for the engine. Perform the following procedures carefully.

## CAUTION

Excessive heat build-up during the first three hours of operation will damage close-fitted engine parts. Do not operate at full throttle or high speeds for extended periods during the break-in period. Do not carry passengers during the break-in period.

Use of any oils other than those recommended by Polaris may cause serious engine damage. We recommend the use of Polaris synthetic 2-cycle oils for your Polaris watercraft.

# OPERATION

## Engine Break-in Procedure

### CAUTION

If the engine is operated while the watercraft is in very shallow water, sand, weeds and debris may be sucked into the jet intake and could cause damage to the impeller or injury to bystanders. Ingesting sand into the cooling system will cause the engine to overheat, which could lead to engine damage.

Whenever starting the engine, always be sure the watercraft is in water at least two feet (60 cm) deep.

1. Make sure the drain plugs are installed securely and launch the watercraft.
2. Push the rear of the watercraft up and down several times in the water.
3. Check the throttle for free operation.
4. Remove the seat and ventilate the engine compartment.
5. Secure the seat, board the craft and start the engine. Allow it to warm up for about a minute before departing.
6. Operate the watercraft at the lowest possible speed for the first five minutes of operation.
7. Gradually open the throttle to half speed (half throttle).
8. Vary throttle speeds up to 3/4 speed during the break-in period (first full tank of fuel).

## Navigational Rules

This watercraft must be operated in accordance with all navigational rules and regulations governing it and the waterway on which it's operated. These rules are used and enforced internationally, as well as by the U.S. Coast Guard and local law enforcement. Any operator of this watercraft should be aware of these rules and should obey them when encountering other vessels.

The following rules are condensed and are provided only for your convenience. Consult a U.S. Coast Guard Auxiliary or Department of Motor Vehicles for a complete set of rules governing the waters where you'll be riding. You may also obtain this information when registering your watercraft.

## Right-of-way and Give-way

In nautical terms the stand-on (privileged) vessel has the right-of-way and the give-way (burdened) vessel must yield or give way.

### Stand-on Vessel

The vessel with the right-of-way has the duty to continue its course and speed, except to avoid an immediate collision. By maintaining course and speed, other vessels should be able to determine how best to avoid interfering with its course.

### Give-way Vessel

The give-way vessel is responsible for taking positive action to stay clear of the stand-on vessel. Give-way vessels should not cross in front of stand-on vessels. The give-way vessel should slow down or change direction briefly and cross behind the stand-on vessel. The give-way vessel's actions should be clear and understandable by the stand-on vessel.

# OPERATION

## Navigational Rules

### Rule 2

Rule 2 is “The General Prudential Rule” of the International Rule. This rule states that all operators have the responsibility of taking action to avoid a collision. All vessels involved in a potential collision become give-way vessels.

### Encountering Vessels

There are three main situations in which you may encounter other vessels:

- Overtaking (passing)
- Meeting (approaching another vessel head-on)
- Crossing (traveling across another vessel’s path)

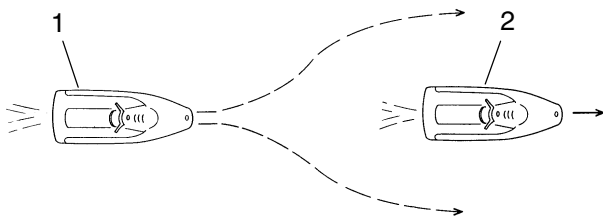

### Meeting Vessels

When meeting another power vessel head-on and a collision appears likely, neither vessel has the right-of-way. Both vessels are obligated to alter course to avoid an accident. Keep the other vessel to your port (left) side and take evasive action to the starboard (right) side (1). This rule does not apply if you’ll be clear of the other vessel by maintaining your course and speed (2).

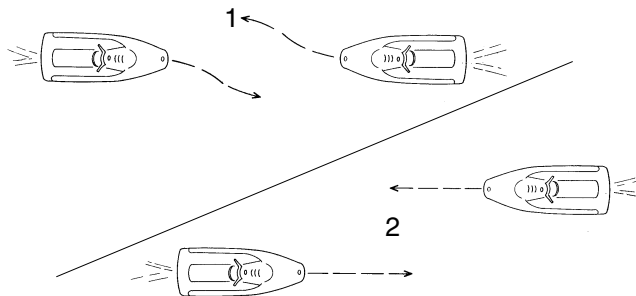

## Navigational Rules Overtaking Vessels

If your watercraft is passing another vessel, your craft is the give-way vessel. The other vessel is expected to maintain its course and speed. You must not interfere with its course of travel.

If your craft is the stand-on vessel, maintain your course and speed until the other vessel has passed you.

## Crossing Paths

When two power vessels are crossing each other's path close enough to run the risk of collision, the vessel having the other on the starboard (right) side must give way. For example, if the other vessel (4) is on your vessel's (3) starboard (right) side, you must give way. If the other vessel is on your port (left) side, your vessel is the stand-on vessel and should maintain its course and direction. The other vessel must give way. However, always drive defensively in case the give-way vessel fails to give your vessel the proper right-of-way. Always be prepared to stop quickly or take evasive action.

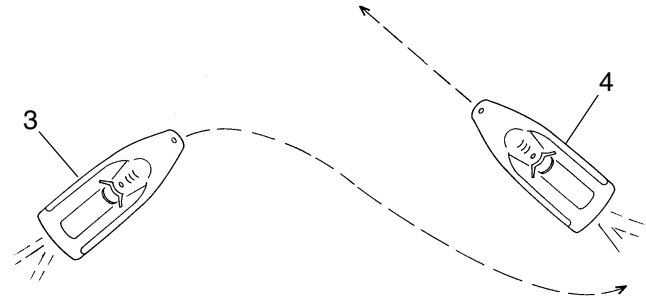

# OPERATION

## Navigational Rules Non-Motorized Craft

Non-motorized craft (sailboats, canoes, etc.) are normally given the right-of-way, with the following exceptions:

- When a non-motorized craft is overtaking a power vessel, the power vessel has the right-of-way.
- Non-motorized craft should stay clear of fishing vessels.
- In a narrow channel, a non-motorized craft should not interfere with the safe passage of a power vessel.

## Fishing Vessel Right-of-Way

All vessels that are fishing with nets, lines or trawls are considered “fishing vessels” under International Rules. Vessels with trolling lines are not considered fishing vessels. Fishing vessels have the right-of-way, regardless of position. However, they must not interfere with the passage of other vessels in narrow channels.



## Navigational Rules

### Avoid Collisions

**SCAN CONSTANTLY** for people, objects and other watercraft. Be alert for conditions that limit your visibility or block your vision of others.

**OPERATE DEFENSIVELY** at safe speeds, and keep a safe distance away from people, objects and other watercraft.

- Do not follow directly behind PWCs or other boats.
- Do not go near others to spray or splash water.
- Avoid sharp turns or other maneuvers that make it hard for others to avoid you or understand your course of travel.
- Avoid shallow water and areas with submerged objects.

**TAKE EARLY ACTION** to avoid collisions. Personal watercraft and other boats do not have brakes.

**DO NOT RELEASE THROTTLE WHEN TRYING TO STEER** away from objects. You need throttle for proper steering. Always check throttle and steering controls for proper operation before starting the craft.

Follow navigation rules and all state and local laws that apply to personal watercraft.

### Reading Buoys and Markers

United States waters are marked for safe navigation through the use of buoys and markers with various shapes, colors, numbers and lights to guide boaters. The same is true for waters in particular states. Marking may vary by geographic location. Consult local authorities before riding your watercraft in unfamiliar waters.

### Launch Ramp Etiquette

Be considerate and efficient when launching your watercraft at a public landing. Prepare your craft in advance, and perform all safety checks before arriving at the landing area. Launch as quickly as possible.

# OPERATION

## Launching the Watercraft

1. Inspect the drain plugs to ensure they're securely installed.
2. Launch the watercraft in an area free of weeds and debris. Make sure the craft is in at least two feet of water before starting the engine.
3. Push the rear of the watercraft up and down several times to flush out any sand that could be trapped in the pump.
4. Remove the seat to ventilate the engine compartment. Reinstall the seat and latch securely.
5. Carefully board the watercraft and sit down.
6. Start the engine as outlined beginning on page 57.

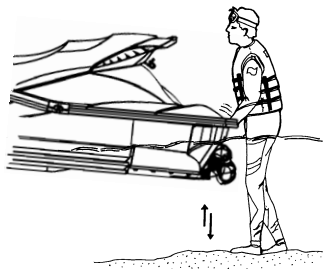

## Stopping the Engine

Do not turn off the engine until the watercraft has stopped moving. Your craft requires engine power for steering, so after the engine has stopped, you'll lose all steering control of the watercraft.

1. Release the throttle lever. When the engine has slowed to an idle and the craft has stopped moving, push in the stop button. The engine should stop immediately. You may also stop the engine by pulling the lanyard lock plate off the engine stop switch.
2. Be sure the water is at least two feet (60 cm) deep when stopping to prevent debris from entering the impeller or cooling system.
3. Remove the lanyard lock plate. Never leave the lanyard attached to an unattended watercraft.

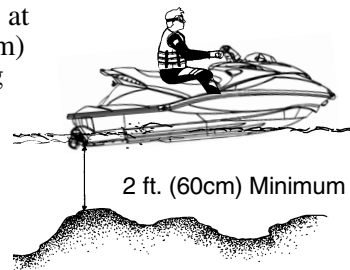

## Before Starting the Engine

Before starting the engine:

1. View the watercraft safety video provided with the watercraft.
2. Read and understand this Owner's Manual.
3. Be familiar with all controls and functions of the watercraft.
4. Perform the pre-operation check found on page 39.

If you have any questions about the features or controls of this watercraft, see your Polaris dealer.

## CAUTION

If the engine is run while the watercraft is in very shallow water, sand, weeds and debris may be sucked into the jet intake and could cause damage to the impeller or injury to bystanders. Ingesting sand into the cooling system will cause the engine to overheat, which could lead to engine damage.

Whenever starting the engine, always be sure the watercraft is in water at least two feet (60 cm) deep.

## Starting the Engine

1. Attach the lanyard wrist band (1) to your left wrist or PFD.
2. Fasten the lanyard lock plate to the engine stop switch on the handlebars by pushing the lock plate around the barrel of the switch. Be sure the lanyard is not tangled around the handlebars or controls.

**NOTE:** The engine will not start if the lanyard lock plate is removed from the engine stop switch.

# OPERATION

## Starting the Engine

### **WARNING**

Starting the engine immediately generates a forward thrust, which could cause an unprepared operator to fall from the machine, causing serious injury or death. Always be seated and alert when starting the watercraft. Never hold the throttle open while starting.

3. Push the starter switch with your left hand while feathering the throttle (very slight open and close motion) with your right hand. As soon as the engine starts, release the starter switch and throttle. Apply just enough throttle to keep the engine running.

**NOTE:** If the engine was run out of fuel, it may take two or three attempts to start the engine. Do not run the starter for more than ten seconds at a time or damage to the starter may result.

### **If the Engine Doesn't Start**

If the engine does not start within 10 seconds, release the starter switch. Wait 10 seconds before trying again to avoid damaging the starter.

### **CAUTION**

Engaging the starter improperly may cause starter wear and eventual failure. Do not depress the starter switch while the engine is running or while the starter is spinning.

If the engine does not start after several attempts, refer to the troubleshooting section of this manual, beginning on page 96.

## Boarding the Watercraft

Practice boarding the watercraft in shallow water before riding in deep water. Any passengers should also practice boarding in the event they must reboard in deep water.

## Boarding and Starting in Deep Water (Operator Only)

Make sure the watercraft engine is turned off when boarding in deep water.

1. Swim to the rear of the watercraft. Grip the boarding handle near the rear of the seat.
2. Pull yourself up onto the boarding platform.
3. Move up to the seat and straddle it.
4. Attach the lanyard lock plate to the engine stop switch and see that the lanyard wrist band is secure on your left wrist before starting the engine.

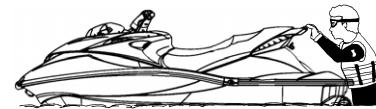

Step 1

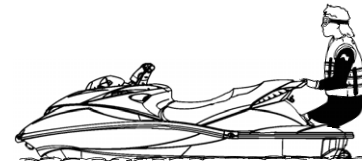

Step 2

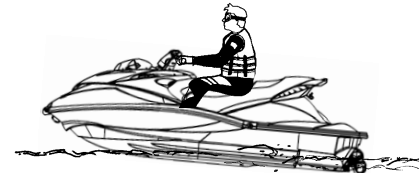

Step 3

# OPERATION

## Boarding the Watercraft Boarding With a Passenger

A watercraft behaves differently with a passenger on board, requiring more operator skill. Practice operating skills alone, before taking a passenger on board. Make sure the watercraft engine is turned off when boarding with a passenger.

1. The operator should board first as outlined on page 59. Attach the lanyard lock plate to the engine stop switch and fasten the lanyard wrist band to the left wrist or PFD. *Do not start the engine yet.*

**NOTE:** During boarding, the passenger should steady the watercraft while the operator boards. The operator can then help balance it while the passenger boards.

2. The passenger should move (or swim) to the rear of the vehicle.
3. The passenger should pull him/herself on board using the grab handle. Both operator and passenger should try to balance the watercraft while the passenger is boarding.
4. The operator should see that the passenger is holding on tightly and that both feet are on the footrests before starting the engine.

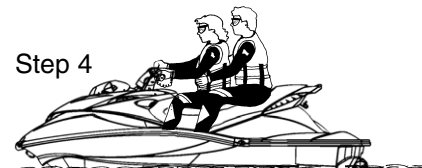
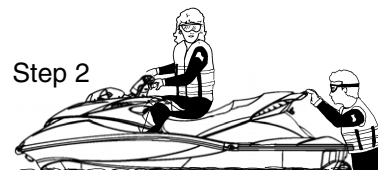
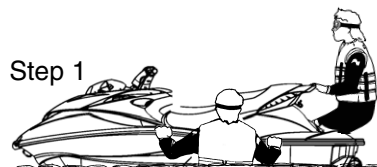

## Reverse Operation

### **⚠️ WARNING**

Activating reverse while the craft is moving forward could cause loss of control and result in damage to the watercraft or severe personal injury to the operator or passenger(s). Do not attempt to activate reverse while moving forward above planing speed.

1. To activate reverse, pull the reverse lever all the way up. The lever will remain in the full up position (1).
2. Turn the handlebars and apply throttle carefully to maintain steering control of the watercraft. **NOTE:** Engine RPM is limited during reverse operation.
3. To return to forward operation, allow the engine to return to idle speed, then return the reverse lever to the forward position.



## Turning the Watercraft

Turning the watercraft requires using the throttle (thrust from the jet pump) and turning the handlebars at the same time. Do not release the throttle when trying to steer.



High thrust makes the watercraft turn more sharply. Lower thrust makes the watercraft turn less sharply.

Making sharp turns at high speeds may cause the watercraft to “spin out” and may cause rider(s) to be ejected from the watercraft. Make gradual turns when operating at higher speeds.

Always look behind the craft before turning to avoid collisions.

# OPERATION

## Stopping the Watercraft

### **⚠ WARNING**

Colliding with an object in the water can result in serious injury to the operator or passengers. All riders must keep feet, arms and hands inside the watercraft at all times, and especially while approaching a dock, vessel or other object. Do not turn off the engine while approaching an object. Engine power is required for steering.

The operator of the watercraft should practice stopping to become familiar with the procedure. Stopping is affected by gross weight (watercraft and rider), vehicle speed, wind direction and water surface conditions.

The watercraft is not equipped with a brake system. When the throttle is released, the natural drag of the water slows and stops the watercraft.

Always keep a safe distance from other vessels, swimmers, objects in the water and the shoreline. Refer to local regulations about safe operating distances for the body of water you operate on.

Allow yourself plenty of room for stopping. When operating at full speed (1), it could take the watercraft as much as 300 feet (90 m) to come to a stop after the throttle is released. *This distance is approximate and is supplied only for reference. Use good judgement and always allow plenty of room for stopping.*

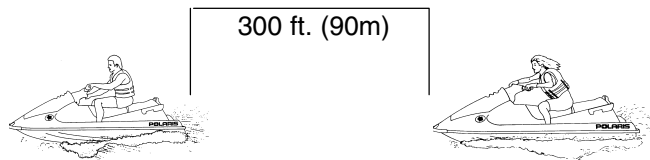

After releasing the throttle, coast toward the desired stopping area with the engine idling. You may need to use the throttle again for steering control.

**NOTE:** Push the engine stop button before entering shallow water to prevent sand and debris from entering the pump and cooling system.



## Beaching the Watercraft

### CAUTION

Sand, pebbles, weeds and debris can enter the jet pump and cause severe damage to components. Ingestion of sand into the cooling system may cause the engine to overheat and could result in severe engine damage. Never beach the watercraft while the engine is running. Shut off the engine when entering water less than two feet (60 cm) deep.

1. *Slowly* approach the beaching area and stop the engine in no less than two feet (60 cm) of water. Make sure there are no swimmers, boats or other obstacles close to the watercraft, as it will be impossible to turn the watercraft after stopping the engine.
2. Dismount the watercraft and guide it to the beach.
3. Before restarting, inspect the impeller/jet pump area for sand and debris.

4. Move the watercraft to at least two feet (60 cm) of water and push the rear of the watercraft up and down in the water to help flush sand and debris out of the pump.

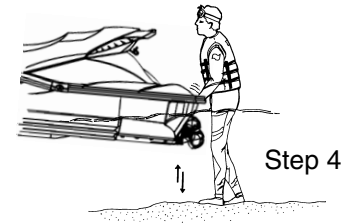
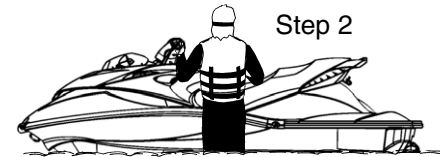

## OPERATION

### Operating in Rough Conditions

If riding in rough conditions, it's possible for the operator to hit his/her chest or face on the watercraft or handlebars and be injured. If the operator is ejected from the craft, injuries may make it difficult to reboard.



Operating the craft in rough water conditions is not recommended, and it's illegal in some states to operate the watercraft in or near the surf line.

### **⚠**WARNING

Riding the watercraft in rough water conditions could cause loss of control, resulting in severe injury or death to the operator and/or passenger. Avoid riding in rough water and/or adverse weather conditions. Do not jump waves with the watercraft.

### CAUTION

Operating with excessive throttle can result in cavitation damage to the impeller or pump. Do not operate at high throttle settings for extended periods while the watercraft is out of the water, including operation in extremely rough water.

## Towing a Disabled Watercraft

If the watercraft becomes inoperable in the water, it can be towed by another watercraft. Before towing, use a vice grip pliers to close off the cooling water inlet hose (1) located at the bottom of the watercraft hull (the hose from the pump box to the exhaust pipe). Clamp it off as near to the T-fitting as possible.

### CAUTION

Failure to clamp off the cooling water inlet hose before towing may result in hydrolock, a condition caused by water being drawn or forced into the engine. Always clamp off the water inlet hose before towing a disabled watercraft.

To tow the craft, securely attach about 20 feet (6 m) of tow rope to the eye located on the bow. Slowly tow the watercraft to shore.

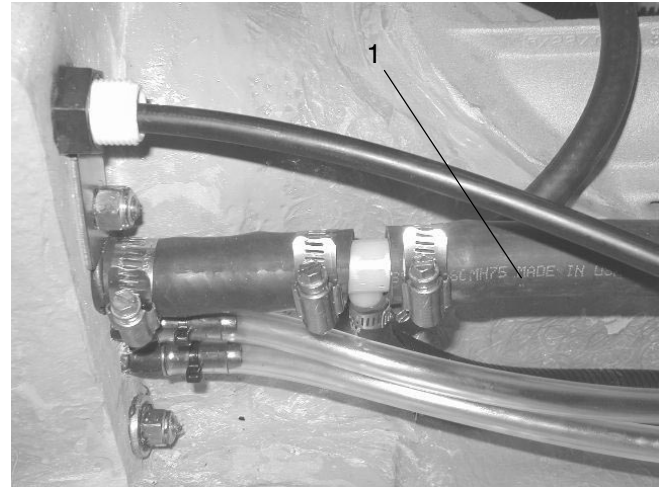

# OPERATION

## Righting a Capsized Watercraft

Capsizing a watercraft is not recommended by Polaris and should be avoided. Overturning a watercraft is not considered the normal operation for which your vehicle is intended.

### **⚠️ WARNING**

This watercraft does not right itself if it has been capsized. If the operator is unable to right a capsized watercraft, operator and passengers may be stranded, which could lead to serious injury or death. Follow the procedures outlined in the owner's manual and on the capsized decal, which is found on the rear of the craft.

### **CAUTION**

Failure to right a capsized craft promptly *and correctly* may result in severe engine damage if the engine is operated with air or water in the lines. A capsized watercraft must be uprighted in a *clockwise* direction as viewed from the rear. If the watercraft has remained in a 180° (capsized) position for more than two minutes, all fuel and oil lines must be inspected for water and/or air.

After righting the craft, follow the procedures for a submerged (waterlogged) engine on page 72 to prevent engine damage.

1. Be sure the engine is stopped immediately after capsizing. The engine will overheat if it continues to run while the craft is capsized.
2. Upright the vehicle immediately by turning it in a clockwise direction *only* (as viewed from the rear).
3. Board the craft from the rear.
4. Remove the seat and bail all water from the engine compartment.
5. Reinstall the seat, sit down and start the engine.
6. If the engine fails to start shortly after being uprighted, make no further attempts to start it. Severe engine damage could result. Follow the procedures for a submerged (waterlogged) engine on page 72.



## Operating With Passengers

### **⚠️ WARNING**

Overloading a watercraft will significantly reduce vehicle stability and control, which could result in an accident and lead to severe injury or death. Never exceed the load capacity for the watercraft.

Polaris watercraft are designed to carry an operator and up to three passengers, depending on the model. Refer to the capacity decal on your craft and the specifications beginning on page 102 to determine your boat's rider capacity. Never exceed the stated capacity for your vehicle.

When more than one person is riding, the watercraft handles differently, which means that the operator must have enough prior riding experience to handle the watercraft with one or more passengers aboard. The operator should be skilled in operation and maneuvers before carrying any passenger.

Passengers should sit behind the operator and face toward the bow of the watercraft. A passenger riding as a spotter in towing situations should face the rear of the craft and hold on to the rear grab handle.

All passengers should read the owner's manual and follow all safety warnings.

Passengers must wear an approved personal flotation device

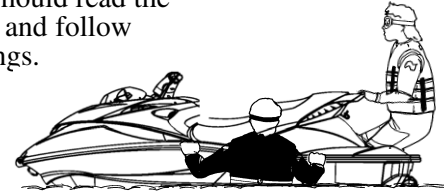

and other recommended safety gear. They should be good swimmers and they should be in good physical condition, as reboarding in deep water can be strenuous.

A passenger should firmly hang on to the operator's PFD or the seat strap and keep both feet on the footwell pads in the gunnel.

The operator should make sure any passenger is properly seated and holding on before accelerating. The operator should also communicate sudden maneuvers to a passenger in advance to prevent an ejection from the craft.

No person should operate or ride on a watercraft unless both feet reach the footrests when sitting on (straddling) the seat.

# OPERATION

## Post Operation Maintenance

### Daily Care

Remove the watercraft from the water every day to inhibit marine organism growth on the hull.

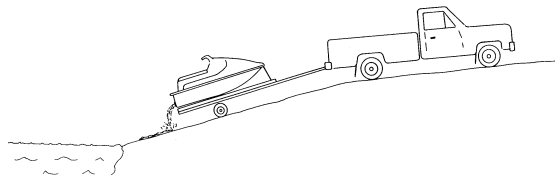

1. Remove the watercraft from the water.
2. Purge residual water from the exhaust system by starting the engine and revving it repeatedly at partial throttle for about ten seconds until water no longer comes out. **NOTE:** If the craft is towed up or down a steep hill after removing it from the water, this procedure may be repeated.

## CAUTION

The engine may overheat and seize if operated out of water. Never operate the engine for more than 15 seconds. Never hold the engine at full throttle while the watercraft is out of the water.

3. Wash the hull, jet pump intake and outlet with fresh water.
4. Remove the drain plugs to drain any water in the bilge.
5. Remove the seat and rinse the engine compartment with a generous amount of fresh water. After the water has drained, wipe the engine compartment (bilge) dry with clean towels.
6. If the craft is used in salt water, Polaris recommends that the inside of the hull (engine and components) be sprayed with T 9 metal protectant after each use. See page 101.
7. Reinstall the seat.
8. Clean the drain plugs and openings and reinstall the plugs.
9. Drain the engine and flush the cooling system. See page 91.

## Post Operation Maintenance Daily Care

### **WARNING**

Serious injury and damage to the watercraft will result if the jet pump and impeller are cleaned while the engine is running. Always stop the engine, remove the lanyard lock plate and disconnect the battery before servicing the jet pump and impeller.

10. Stop the engine and disable all starting mechanisms. Clean the jet pump and impeller of any weeds and debris that may have collected during operation.
11. Inspect the area for damage. If damage is found, see your Polaris dealer for service.

**NOTE:** Whenever possible, avoid operating the watercraft in weedy areas. If it's unavoidable, vary the watercraft speed, as weeds tend to accumulate more rapidly at steady and trolling speeds.

# OPERATION

## Post Operation Maintenance

### Temporary Storage

If the watercraft will be stored temporarily (less than 30 days), perform the daily maintenance procedures beginning on page 68 and also perform the following temporary storage procedures.

1. Block the seat (engine compartment) open about 1/2" (1.3 cm) to provide air circulation and to prevent condensation from forming.
2. If the seat is saturated with water, stand it on end and allow it to dry out. When dry, store the seat on the craft as outlined in step 1.
3. When storing the watercraft, make sure the nose is positioned upward at a 20° angle for drainage.
4. Check the screen in the pump stationary nozzle for plugging. See instructions on page 90.

### WARNING

Serious injury and damage to the watercraft will result if the jet pump and impeller are cleaned while the engine is running. Always stop the engine, remove the lanyard lock plate and disconnect the battery before servicing the jet pump and impeller.

### CAUTION

Operation of the engine with the intake system removed could result in serious engine damage. Never operate the engine with the intake system removed.



## Post Operation Maintenance

### Transporting The Watercraft

Do not route ropes or tie downs over the seat as they could cause permanent damage to the seat. Protect the watercraft body by placing padding or similar material between the ropes or cables and the watercraft body.

Be sure the trailer matches the watercraft's weight and design and that it meets trailer laws and regulations in your area.

We recommend the use of a Polaris watercraft cover for protection from rocks and other debris while transporting.

1. Tie the watercraft securely to the trailer at the bow and stern. Use additional cables if necessary. There should be no movement between the watercraft and trailer.
2. Make sure the seat is securely latched.

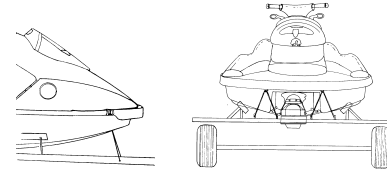

OR

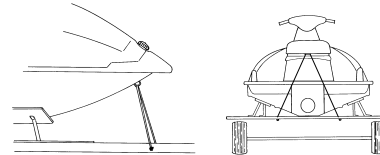

# OPERATION

## Post Operation Maintenance

### Battery

If the watercraft battery is run down, remove it and have it recharged. Refer to battery charging recommendations and service procedures beginning on page 86.

### WARNING

A weak battery may not be able to start the engine and could leave you stranded, which could result in severe injury or death. Never operate the watercraft with a weak battery.

### Anti-Corrosion Treatment

Spray all the metal components in the engine compartment with a lubricating type rust inhibitor. We recommend T9 metal protectant.

Apply dielectric grease on battery terminals and connections.

**NOTE:** Never leave shop cloths or tools in the engine compartment or bilge.

### Submerged (Waterlogged) Engine

If the engine becomes water-flooded, tow the craft to shore and immediately perform the following procedures.

### CAUTION

Severe engine damage could result if the engine is operated with air or water in the lines. If the watercraft has remained in a 180° (capsized) position for more than two minutes, all fuel and oil lines must be inspected for water and/or air. Do not attempt to start the engine.

1. Remove the watercraft from the water.
2. Remove the drain plugs, drain the water from the bilge and bring the watercraft to an authorized Polaris dealer for service.

**NOTE:** Only mechanically experienced individuals should attempt to remove water from a waterlogged engine. Use the procedure on page 73. All others should take the watercraft to an authorized Polaris dealer for service. If this is not possible, call your Polaris dealer for further instructions.

## Post Operation Maintenance Engine Water Removal Procedure

Use the following procedure for removing water from a submerged engine. Attempt this procedure only if you are mechanically experienced and have adequate assistance for lifting and supporting the watercraft.

### **WARNING**

Accidental starting during the water removal procedure could cause severe personal injury. Before removing water from a submerged engine, make sure the lanyard cord and lock plate are removed from the engine stop switch.

1. Remove the watercraft from the water. Remove the lanyard cord from the engine stop switch and place the watercraft on a flat surface, allowing room to roll it onto its side later.
2. Remove the drain plugs and drain the water from the bilge.
3. Remove the seat and remove the spark plugs.
4. Tip the watercraft on its right side (to starboard) until the spark plug holes are just below horizontal. While assistants hold the watercraft in this position, turn the driveshaft by hand to rotate the engine and allow the water to run out.
5. Upright the watercraft and inspect and dry the spark plug holes. Install new spark plugs.
6. Install the air intake.
7. Check the battery vent hose for obstructions and drain any water from the hose.
8. Check the fuel and oil for the presence of water. If water is present, take the watercraft to an authorized Polaris dealer for immediate service. Do not run the craft if water is present in the fuel or oil.
9. Verify that no air is present in the oil line.
10. Reinstall the drain plugs and the seat.

# MAINTENANCE AND LUBRICATION

## General Maintenance

Replace the pop-off valve, spring and seals every 100 hours.

Replace inlet and outlet hoses and clamps every 100 hours.

After washing the engine compartment of the watercraft, protect the metal components with a T9 Metal Protectant or another *non-flammable* metal protectant. Do not use flammable sprays or protectants in the engine compartment. Do not use petroleum based protectants or lubricants in the engine compartment, as most are flammable and may also deteriorate rubber components.

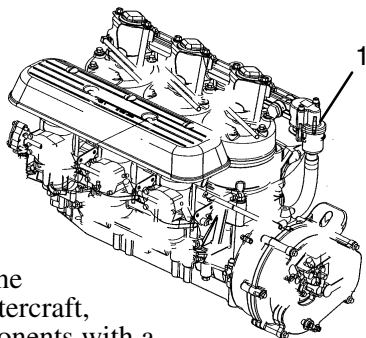

# MAINTENANCE AND LUBRICATION

## Periodic Maintenance Schedule

**NOTE:** Maintenance intervals are based upon average operating conditions. Watercraft operated in saltwater require daily corrosion protection and engine flushing, and more frequent maintenance and lubrication.

Fogging kits should be added to all Polaris watercraft. The engine should be fogged if the watercraft will not be used for more than 48 hours.

## Maintenance Schedule Key

- \* Perform every 15 hours or monthly when operated in salt water.
- \*\* Perform daily when operated in salt water.
- \*\*\* Spider rubber coupler, driveshaft and bearing carrier (seals and bearing) - Perform pre-season (annually), at 50 hours and when pump is disassembled for maintenance.

# MAINTENANCE AND LUBRICATION

## Periodic Maintenance Schedule

DESCRIPTION	Pre-ride	Pre-season	Monthly or 25 hrs.	3 mos. or 50 hrs.	6 mos. or 100 hrs.	Tune up item
<b>ENGINE</b>						
Engine corrosion protection/fogging(daily-if used in salt water)	L**	L	L			
Cooling system flushing (daily after use in salt water)	I**	I				•
Exhaust cooling hose screen		I/C		I/C		•
Exhaust hose condition		I		I		
Engine mounts (replace if removed for engine service)		I			I	•
Thermostat/popoff valve assembly/spring		I/C	I/C*		R	•
Water inlet and outlet hoses and clamps		I	I	I	R	
Spark plugs/Compression test		I			I	•
Spark Plugs (replace every 100 hours)		R		I	R	
Engine fastener re-torque (cyl head/cyl base, exhaust)		I			I	•
Oil pump adjustment		I		I		•
<b>ELECTRICAL</b>						
Battery condition, fluid level	I	I				•
Battery vent hose condition/routing (must be clear)		I		I		•
Battery and starter cables(clean connections / tight)		I		I	I	•
Ground cables-condition, corrosion, fastener torque		I		I	I	
Engine overheat warning/tone/electrical connections		I			I	
Lanyard cord/engine stop switch	I	I				•

I - Inspect, adjust, service, replace if necessary

A - Adjust

C - Clean

R - Replace

L - Lubricate with recommended lubricant

# MAINTENANCE AND LUBRICATION

## Periodic Maintenance Schedule

DESCRIPTION	Pre-ride	Pre-season	Monthly or 25 hrs.	3 mos. or 50 hrs.	6 mos. or 100 hrs.	Tune up item
<b>FUEL SYSTEM</b>						
Fuel filter and oil filter		R	I			•
Throttle cable	I	I/L/A		L		•
Fuel cap/oil cap gaskets	I	I	I	I	R	
Fuel lines, oil lines, related hose clamps, check valves and hose inspection, fuel system pressurization		I			I	•
Vent system (oil and fuel) check-valves; hose routing		I				•
Fuel system pressure/vacuum test		I				
Air intake silencer		I/C				•
<b>JET PUMP</b>						
Drive shaft/spider coupler/bearing carrier (seals, bearings)		I	I	I	I	•
Drive shaft shroud condition		I	I			•
Siphon system pick-up screens and hoses	I/C	I/C				•
Cooling water inlet screen/hoses, clamps	I/C	I/C				•
Jet pump intake grate fasteners and condition		I		I		•
Impeller condition and impeller clearance		I			I	•
Pump Sacrificial Anode		I		I		•
Reverse mechanism		I/A		I/A		•

I - Inspect, adjust, service, replace if necessary

A - Adjust

C - Clean

R - Replace

L - Lubricate with recommended lubricant

# MAINTENANCE AND LUBRICATION

## Periodic Maintenance Schedule

DESCRIPTION	Pre-ride	Pre-season	Monthly or 25 hrs.	3 mos. or 50 hrs.	6 mos. or 100 hrs.	Tune up item
<b>HULL / DECK / STEERING / CONTROLS</b>						
Steering support hub bushings/fasteners/handgrips		I/L			I/L	•
Steering cable		I/L/A		I/L		•
Steering Nozzle Bushings	I				R	
Reverse cable inspection, lubrication	I	I/L/A		I/L/A		
Handlebar/steering operation (turns fully/freely/fasteners)	I	I				•
Hull, clean and inspect for cracks, damage, or leaks	I	C/I				
Drain Plug Condition	I	I				•
Bilge system inspection, should not leak	I	I			I	
Seat and compartment seals (condition of seal)		I/A	I/A			•
Fire extinguisher		I			I	•
Inspect and tighten all fasteners, including throttle body mounts, engine mounts, exhaust system, all hose clamps; inspect muffler, battery, oil and fuel tank fastening devices, pump, steering fasteners. Aggressive riding requires more frequent service.		I	I			•

I - Inspect, adjust, service, replace if necessary

A - Adjust

C - Clean

R - Replace

L - Lubricate with recommended lubricant



# MAINTENANCE AND LUBRICATION

## Lubrication

Proper lubrication and corrosion protection are necessary to maintain optimum performance and ensure years of service from your watercraft. We recommend the use of Polaris All Season Premium Grease. See page 101 for part numbers of Polaris products.

## Throttle Cable

1. Lubricate the throttle cable by depressing the throttle lever and squirting grease onto the cable.
2. Push and release the throttle several times to work the grease down the cable.

## Steering Cable Joints and Inner Wire

1. Lubricate the steering cable joints on the steering nozzle end.
2. Expose the steering cable inner cable and apply grease. Lubricate the steering nozzle end and the handlebar end.

**NOTE:** Cable seals can be moved to allow grease into the cable. Make sure the seals are put back in the proper location after applying grease.

## Drive Line

The drive line consists of a drive shaft spider coupler and a bearing carrier with a sealed bearing inside. It does not require routine greasing. However, grease is required during reassembly of the system when it's been disassembled for service. Grease must be applied to the drive shaft before it's installed through the bearing carrier. **NOTE:** We recommend that all drive line service be performed by your Polaris dealer.

## CAUTION

Failure to apply grease to the driveshaft during reassembly through the bearing carrier will result in dislodged seals and improper operation of the system. Always apply grease when reassembling.

Inspect the rubber spider coupler (1) monthly. See your Polaris dealer for replacement if wear or damage is found.

Inspect the bearing carrier (2) for water leaks through or around the drive shaft. See your Polaris dealer for replacement if a leak is detected.

# MAINTENANCE AND LUBRICATION

## Lubrication

### Seat Latch And Hooks

Grease the locking mechanism of the seat latch at the rear of the seat opening.

### Throttle Body And Oil Injection Pump

Grease springs, exposed portions of cable and shafts at the throttle bodies. Grease often if used in salt water.

### Electrical Connections

Apply dielectric grease to battery posts and exposed cable connections.

### Steering Nozzle Pivot Shaft

Lubricate the steering nozzle shaft pivot connections (1).

### Steering Handle Pivot Shaft

Lubricate the handle pivot shaft and bushing (2). Tighten the steering shaft if it's loose.

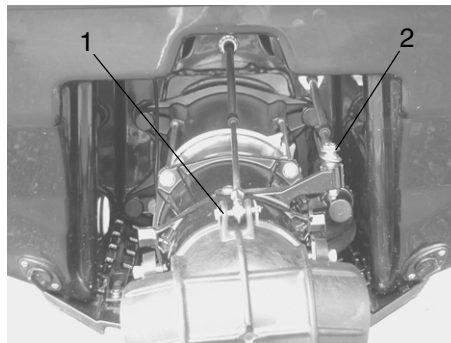

# MAINTENANCE AND LUBRICATION

## Spark Plugs

Always use the recommended spark plugs for your Polaris watercraft and make sure the spark plug gap is within specification. Measure gap (1) with a wire thickness gauge.

- Use NGK PZFR6H spark plugs.
- Proper electrode gap is .028" +/- .002" (.71 mm +/- .05 mm).
- Spark plug torque is 18 ft. lbs. (24 Nm).

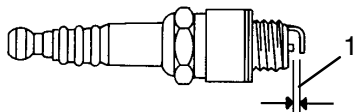

## CAUTION

Using non-recommended spark plugs can result in serious engine damage. Always use the spark plugs recommended for your Polaris watercraft.

Spark plug condition is indicative of engine operation. The spark plug firing end condition should be read after the engine has been warmed up and the vehicle has been driven at higher speeds. Immediately check the spark plug for correct color.

- A slightly brownish tip is considered normal. The engine is running properly.
- A yellow tip is caused by salt water mist ingestion. This conductive coating will eventually cause fouling. This is a normal situation.

**NOTE:** If the spark plug tip is black or grey, have the watercraft serviced by an authorized Polaris dealer as soon as possible.

- A black tip indicates several potential problems: the wrong spark plug (wrong heat range) is being used; excessive idling occurs; the carburetor idle speed mixture or high speed mixture is too rich or the RPM limiter is malfunctioning.
- A light grey or white tip indicates that the wrong spark plug (wrong heat range) is being used; the carburetor idle speed mixture is too lean; a fuel filter is plugged or an engine seal or gasket is leaking.

# MAINTENANCE AND LUBRICATION

## Spark Plugs

A spark plug with cracked porcelain or damaged threads should be changed immediately. If the electrodes are badly worn or burned the plug should also be replaced.

If the spark plug is in good condition, clean it with a clean shop cloth and/or wire brush. Adjust the gap to the recommended dimension using a wire thickness gauge.

### **WARNING**

Removing a spark plug while the engine or exhaust system is hot could result in serious burns. Wait until the engine has cooled or wear protective gloves while servicing the spark plug.

### **WARNING**

High tension voltage is present in the spark plug wires when the engine is running. Contacting the wires could cause serious injury. Never touch spark plug wires when the engine is being cranked or operated.

Wipe any water from the spark plug and the inside of the cap. Install the spark plug and torque to 18 ft. lbs. (24 Nm). If a torque wrench is not available, 1/4 to 1/2 turn beyond finger-tight is close to the correct torque. Push the cap down on the plug until it clicks.  
**NOTE:** Apply dielectric grease to the inside of the spark plug cap to prevent corrosion. Before installing a *used* plug, wipe off the threads and apply dielectric grease. Also clean the gasket surface.

# MAINTENANCE AND LUBRICATION

## Hull and Deck Care

The use of non-recommended cleaning or polishing products could seriously damage the appearance and/or integrity of your watercraft's gelcoat surface. We recommend the use of the Polaris products listed on page 101. See your Polaris dealer for additional information about the care of your watercraft.

# MAINTENANCE AND LUBRICATION

## Oil

Polaris synthetic 2-cycle oils are formulated specifically to work with your Polaris Liberty marine engine. They've been thoroughly tested and provide the ultimate in performance and protection for your engine. In addition, our biodegradable oil is environmentally friendly. See page 101 for the part numbers of Polaris products.

### CAUTION

Mixing brands or using a non-recommended oil may cause serious engine damage. Always use a recommended oil. Never mix oil brands.

### Polaris VES II Synthetic Lubricant

- A new, cleaner burning formula for improved exhaust valve performance while maintaining lubricity in heat soaked engines
- The first 2-cycle oil in the industry to meet category 4 low temperature viscosity tests
- Reduced odor (virtually no odor) and doesn't cause "eye burn"
- Smokeless
- 100 % synthetic formula offers superior lubrication, along with friction modifiers to maximize wear protection
- Compatible (mixable) with all Polaris 2-cycle oils

### Polaris Premium Gold Synthetic Lubricant

- Lower smoke
- Superior lubrication

### Polaris Nature Oil Synthetic Lubricant

- The same features and benefits as VES II
- Biodegradable, making it even more environmentally friendly

# MAINTENANCE AND LUBRICATION

## Steering Cable Inspection

1. The handlebars and steering nozzle should operate smoothly. If movement is stiff, see your authorized Polaris dealer for service.
2. Turn the handlebars from lock to lock and check to be sure that the clearances between the steering nozzle and the rear hull are even on both sides. If the alignment is not even, see your authorized Polaris dealer for service.

## Throttle Cable Inspection

1. Depress and release the throttle lever. It should return to its initial position smoothly. If it doesn't, see your authorized Polaris dealer for service.
2. Throttle lever free-play should not exceed .020"-.060" (.5-1.5 mm). If it does, see your authorized Polaris dealer for service.

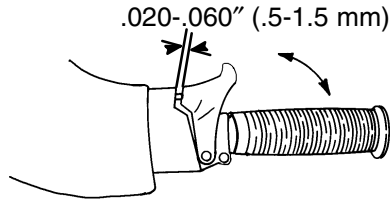

## Fuses

The NGI is protected by a 2 amp fuse. There are also two 15 amp inline fuses on the chassis harness for the fuel pump and any battery powered accessories.

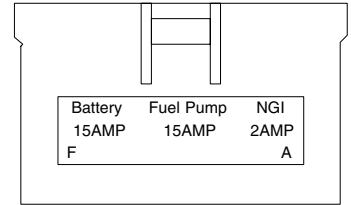

After changing a fuse, always reinstall the weathertight cover to keep the fuses dry.

# MAINTENANCE AND LUBRICATION

## Battery

### Battery Maintenance and Charging

#### **⚠️ WARNING**

Battery electrolyte is poisonous. It contains sulfuric acid. Serious burns can result from contact with skin, eyes or clothing.

#### **Antidote:**

**External:** Flush with water.

**Internal:** Drink large quantities of water or milk. Follow with milk of magnesia, beaten egg, or vegetable oil. Call physician immediately.

**Eyes:** Flush with water for 15 minutes and get prompt medical attention.

Batteries produce explosive gases. Keep sparks, flame, cigarettes, etc. away. Ventilate when charging or using in an enclosed space. Always shield eyes when working near batteries. **KEEP OUT OF REACH OF CHILDREN.**

Keep the battery terminals and connections free of corrosion. If cleaning is necessary, remove the corrosion with a stiff wire brush. Wash with a solution of one tablespoon baking soda and one cup water. Rinse well with tap water and dry off with clean shop towels. Coat the terminals with dielectric grease or petroleum jelly. Be careful not to allow cleaning solution or tap water into the battery.

#### **Replenishing Battery Fluid**

A poorly maintained battery will deteriorate rapidly. Check the battery fluid level often. The fluid level should be kept between the upper and lower level marks (1).

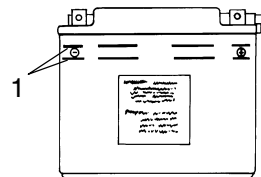

To refill use only distilled water. Tap water contains minerals that are harmful to batteries.



# MAINTENANCE AND LUBRICATION

## Battery

### **⚠ WARNING**

Improperly connecting or disconnecting battery cables can result in an explosion and cause serious injury or death. When removing the battery, always disconnect the negative (black) cable first. When reinstalling the battery, always connect the negative (black) cable last.

### Battery Removal

1. Release the battery by loosening the straps (1).
2. Remove the battery vent tube from the battery.
3. Disconnect the black (negative) battery cable first.
4. Disconnect the red (positive) battery cable next.
5. Lift the battery out of the watercraft, being careful not to tip it sideways and spill electrolyte.

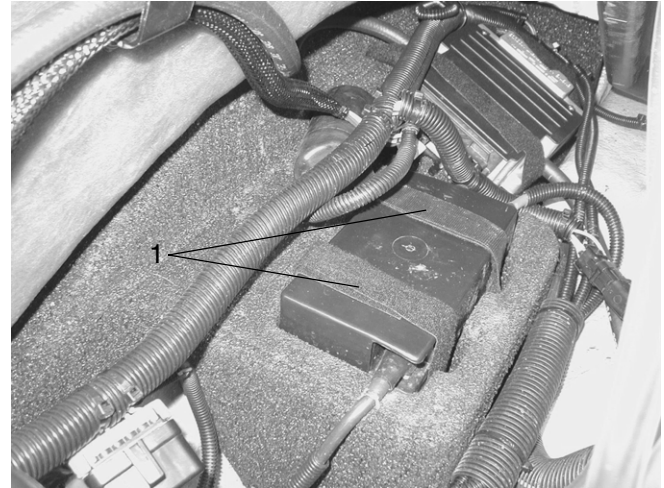

### **CAUTION**

If electrolyte spills, immediately wash it off with a solution of one tablespoon baking soda and one cup water to prevent damage to the vehicle.

# MAINTENANCE AND LUBRICATION

## Battery Battery Charging

### **⚠️ WARNING**

Batteries produce explosive gases. Any sparks in the area could result in an explosion and cause serious injury or death.

Keep sparks, flame, cigarettes, etc. away.

Never charge a battery while it's in the watercraft. Always remove the battery and charge in a safe area.

Make sure the battery charger is turned off and unplugged before connecting the cables to a battery.

Ventilate when charging or using in an enclosed space.

Always shield eyes when working near batteries.

Make sure the battery charger is turned off and unplugged before connecting the cables to the battery. This prevents the possibility of sparks at the terminals, which could ignite the battery gases.

1. Remove the caps from the cells (1). Add distilled water, if necessary, to bring the electrolyte up to the proper level.

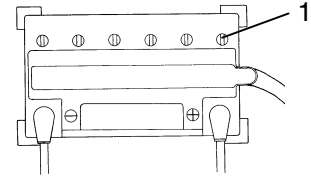

2. Connect the battery to the charger. Set the charging rate at 1.9 amps, plug in the charger and charge the battery for ten hours.

**NOTE:** If electrolyte temperature rises above 115° F. (45° C) during charging, reduce the charging rate to lower the temperature. Increase the charging time.

3. After the battery is charged, check the fluid level. If it dropped, add distilled water to bring the electrolyte up to the proper level.
4. Check the results of charging. The specific gravity of each cell must be 1.26 at room temperature. The voltage should be 14.5-15.5 V during charging and 12.2-12.8 V after charging.

# MAINTENANCE AND LUBRICATION

## Battery

### Battery Installation

1. Set the battery in the battery holder.
2. Install the battery vent tube. **NOTE:** It must be free of obstructions and securely installed. If not, battery gases could accumulate and cause an explosion. The tube should be routed away from the frame and body to prevent corrosion. Avoid skin contact with electrolyte, which can cause severe burns.
3. Connect and tighten the red (positive) cable first.
4. Connect and tighten the black (negative) cable last.
5. Apply dielectric grease to each cable.
6. Reinstall the battery cover and attach the hold-down straps.
7. Verify that cables are properly routed.

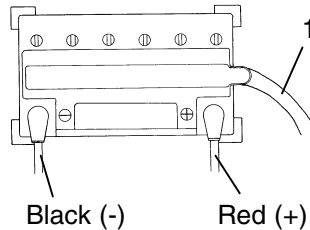

**NOTE:** When installing a new battery, make sure it's fully charged prior to its initial use. Using a new battery that has not been fully charged can damage the battery and result in a shorter life. It can also hinder vehicle performance.

### Battery Storage

1. Remove the battery. Clean the casing and terminals with baking soda and water (one tablespoon of baking soda to one cup water). Apply dielectric grease or petroleum jelly to battery terminals and all exposed cable connectors.
2. Top off the battery with distilled water and charge it to a specific gravity of 1.26.
3. Recharge the battery monthly to prevent battery discharge and sulfating or use a Polaris Battery Tender™ battery charger or similar trickle charger to maintain the charge during the storage period. Follow the instructions provided with the charger.
4. Store the battery in a cool, dry place out of direct sunlight.

# MAINTENANCE AND LUBRICATION

## Salt Water and Unclean Water Care

When the watercraft is operated in salt water or water with impurities like silt, sand and other particulates, additional cleaning and maintenance is mandatory after each use. Clean the jet pump water inlet screen and all other affected areas of the watercraft. Flush the cooling system.

### CAUTION

Failure to perform additional cleaning and maintenance when the watercraft is operated in unclean or salt water will result in damage and corrosion to the watercraft. Clean all affected areas of the watercraft after every use in salt water or unclean water.

## Jet Pump Water Inlet Screen

The water inlet screen (1) is located inside the stationary nozzle of the jet pump. Its purpose is to screen out grass and debris that could enter the coolant system.

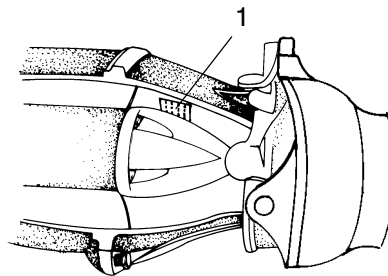

After using the watercraft, visually inspect the screen for buildup of contaminants. Clean as required by flushing engine and/or screen with fresh water. See flushing procedure on page 91.

If the screen cannot be cleaned by flushing, see your Polaris dealer for additional cleaning.

# MAINTENANCE AND LUBRICATION

## Cooling System Flushing

The watercraft uses water for propulsion and for cooling. Flushing the cooling system with fresh water (never anti-freeze) will neutralize the corroding effects of salt water or water with impurities like silt, sand, alkali and other particles. Flushing will also clean out other residue left in the water passages of the watercraft cooling system.

Flush the water passages every day the watercraft is used, any time the craft has been beached and before storing the craft for an extended time.

### CAUTION

Failure to follow the recommended flushing procedure or flushing the engine while it's hot could result in serious engine damage. Always follow the recommended flushing procedures. Always allow the engine to cool sufficiently before flushing. Always flush the cooling system any time the watercraft has been beached.

Polaris recommends the use of Flush Kit PN 2873623 when flushing the cooling system.

1. Attach a garden hose to the female coupler/hose attachment.
2. Snap the male and female coupler together.
3. Start the watercraft engine and immediately turn on the water faucet.
4. Rev the engine intermittently for one minute to completely flush the cooling system.
5. Turn off the water faucet.
6. When all water has exited the cooling system, turn off the engine. **NOTE:** This step should not take longer than 10 seconds.
7. Press the button on the female coupler/hose attachment and separate from male coupler.

# MAINTENANCE AND LUBRICATION

## Extended Storage

When the watercraft will not be used for a month or more, preventative maintenance is required to keep components from deteriorating. An authorized Polaris dealer can do the required preventative maintenance or you can do it yourself with a minimum of tools.

Perform all of the procedures outlined in this section of your owner's manual before storing the watercraft. Refer to page 101 for part numbers of Polaris products. Clean the cooling system according to instructions on page 91.

## Engine and Exhaust System Draining

Engine draining is automatic, but the exhaust system must be drained.

1. Start the engine and briefly rev it.
2. When preparing your watercraft for off-season storage, we recommend that you add Polaris Carbon Clean to the fuel tank, then top off with fresh fuel.
3. Fog the engine with rust preventing oil. Follow the recommended procedures on page 93.

**NOTE:** Using a fuel stabilizer and topping off the fuel tank eliminates the need to drain the fuel system. If you prefer to drain the fuel tank, use the following procedure.

## WARNING

Gasoline is highly flammable and explosive under certain conditions. Always exercise extreme caution whenever handling gasoline. Read and heed all gasoline warnings found on page 40.

1. Drain the fuel tank with a siphon or pump.
2. Leave the fuel cap loose to prevent condensation from forming in the fuel tank.

**NOTE:** Perform the next two steps simultaneously.

3. Fog the engine with rust preventative oil. Follow the instructions on the can.
4. Start the engine and run it at partial throttle to dry out the throttle bodies. Do not run the engine for more than 15 seconds while the watercraft is out of the water. Wait five minutes between 15 second running periods.

# MAINTENANCE AND LUBRICATION

## Extended Storage

### CAUTION

Failure to fog the engine can result in serious engine corrosion during off season or extended storage. Always fog the engine as outlined before storing the watercraft for extended periods.

## Watercraft Engine Fogging Procedure

Polaris recommends the use of fogging oil to prevent rust and corrosion on internal engine parts (i.e. crankshaft, bearings, pistons, rings, cylinder walls). The fogging oil coats all internal parts for prevention of rust and corrosion, which in turn will extend the life of the engine. See page 101 for part numbers of Polaris products.

1. Remove the three caps (1) in the top of the air intake cover.

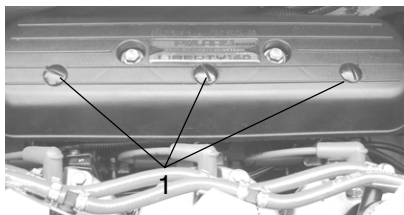

2. Start the engine and spray Polaris fogging oil into the hole in the intake cover (2) to ensure that all internal parts are properly coated. Spray the oil for *two to three*

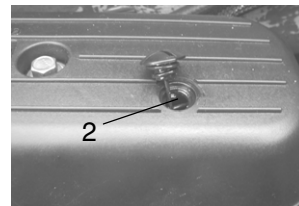

*seconds* in each hole and repeat to flood the engine with fogging oil. Immediately stop the engine.

### CAUTION

Operating the engine while the watercraft is out of the water will cause the engine to overheat and seize. Never operate the engine for more than 15 seconds while the watercraft is out of the water.

3. Replace the caps in the air intake cover.

# MAINTENANCE AND LUBRICATION

## Extended Storage

### CAUTION

Never clean the watercraft with strong detergents, abrasives, degreasers, paint thinner, acetone, window cleaners, ammonia or products containing alcohol. They can damage finishes, decals, vinyl and plastics and accelerate UV breakdown, which could cause color change and premature deterioration of parts.

### Cleaning

1. Remove the drain plugs and clean the bilge and engine area with hot water and mild detergent (such as dish soap) or with bilge cleaner. Rinse and drain thoroughly. Wipe up remaining water with clean, dry shop cloths. Do not use abrasive cleaners.

**NOTE:** Store the watercraft with the drain plugs removed and the seat propped open slightly to inhibit condensation from forming in the engine compartment.

2. Wash the exterior of the watercraft with fresh water and a mild detergent. Rinse thoroughly.  
**NOTE:** Clean metallic gelcoat surfaces gently. Polaris does not recommend the use of power buffers or other power equipment to clean gelcoat surfaces.
3. Inspect and thoroughly clean the jet pump intake, outlet and impeller area. If damage to these areas is visible, see your Polaris dealer for service.
4. After cleaning, protect the watercraft by hand polishing with a regular furniture polish or non-abrasive silicone wax. Protect the seat and handlebar unit with a vinyl protector.
5. Spray the exterior of the engine with T9 metal protectant.
6. Cover the watercraft with an opaque tarp or Polaris watercraft cover and store the craft in a clean, dry place.  
**NOTE:** Make sure the nose is positioned upward at a 10° angle to allow water drainage during storage.



## Extended Storage

### Lubrication

1. Remove the spark plugs and pour about one tablespoon of a recommended 2-cycle oil into each cylinder.
2. Inspect the spark plugs and apply dielectric grease to the threads. Install new plugs if necessary.
3. Lubricate the throttle and steering cables as outlined on page 79.
4. Lubricate all areas recommended in the maintenance section beginning on page 79.
5. Remove and store the battery as outlined beginning on page 86.

# ENGINE TROUBLESHOOTING

## Engine Doesn't Turn Over

Possible Cause	Solution
Blown fuse	Replace the fuse
Low battery voltage	Recharge battery to 12.5 VDC
Loose battery connections or ground	Check all connections and tighten as needed
Hydrolock (water in engine)	See your Polaris dealer
Loose starter relay (solenoid) connections	Check all connections and tighten
Lanyard lock plate not in place	Install lock plate under shut-off switch

## Engine Turns Over But Doesn't Start

Possible Cause	Solution
Out of fuel	Refuel
Old or non-recommended fuel	Replace with new fuel
Fouled or defective spark plugs	Inspect plugs, replace as needed
Crankcase filled with water or fuel	See your Polaris dealer
Clogged fuel filter	Replace the filter
Low battery voltage	Recharge battery to 12.5 VDC
Mechanical failure	See your Polaris dealer

# ENGINE TROUBLESHOOTING

## Engine Runs Irregularly, Stalls or Misfires

<b>Possible Weak Spark Cause</b>	<b>Solution</b>
Fouled or defective spark plugs	Inspect, clean and/or replace spark plugs
Worn or defective spark plug wires	See your Polaris dealer
Incorrect spark plug gap or heat range	Set gap to specs or replace plugs
Loose spark plug connections	Check all connections and tighten
Water present in fuel	Replace with new fuel
Clogged exhaust pipe screen fitting	Clean screen fitting
Water in exhaust pipe	Drain exhaust
Low battery voltage	Recharge battery to 12.5 VDC
<b>Possible Lean Fuel Mixture Cause</b>	<b>Solution</b>
Low or contaminated fuel	Add or change fuel, clean the fuel system
Low octane fuel	Replace with recommended fuel
Clogged fuel filter	See your Polaris dealer
<b>Possible Rich Fuel Mixture Cause</b>	<b>Solution</b>
Fuel is very high octane	Replace with lower octane recommended fuel

# ENGINE TROUBLESHOOTING

## Engine Overheats

Possible Cause	Solution
Clogged jet pump intake	Clean intake
Use of non-recommended fuel or oil	Replace with recommended fluids
Sand or debris in cooling system	Flush the cooling system
Plugged thermostat assembly	Disassemble and clean thermostat
Plugged cooling system	Inspect and clean cooling system
Clogged exhaust pipe screen fitting	Clean screen fitting

## Engine Backfires

Possible Cause	Solution
Weak spark from spark plugs	Inspect, clean and/or replace spark plugs
Incorrect spark plug gap	Set gap to specs or replace plugs
Old or non-recommended fuel	Replace with new fuel
Incorrectly installed spark plug wires	See your Polaris dealer
Broken reed petals/valves	See your Polaris dealer
Incorrect ignition timing	See your Polaris dealer
Mechanical failure	See your Polaris dealer

# ENGINE TROUBLESHOOTING

## Engine Pings or Knocks

Possible Cause	Solution
Poor quality or low octane fuel	Replace with recommended fuel
Incorrect ignition timing	See your Polaris dealer
Incorrect spark plug gap	Set gap to specs or replace plugs

## Engine Loses Power

Possible Cause	Solution
Weak spark	Replace spark plugs and/or wires
Incorrect fuel or fuel mixture	Replace with recommended fuel
Water present in fuel or oil tank	Replace with recommended fluids
Clogged fuel filter	See your Polaris dealer
Clogged jet pump intake	Clean intake
Clogged exhaust and/or cooling system	Clean exhaust, flush cooling system
Hydrolock	See your Polaris dealer
Too much load/weight on craft	Reduce load per vehicle specifications
Mechanical failure	See your Polaris dealer

# ENGINE TROUBLESHOOTING

## Engine RPM is Too High With Limited Speed

Possible Cause	Solution
Clogged jet pump intake	Clean intake
Cavitation, impeller damaged or worn	See your Polaris dealer

## Unusual Noise or Vibration From Propulsion System

Possible Cause	Solution
Weeds or debris lodged in impeller	Clean the impeller
Damaged driveshaft	See your Polaris dealer
Damaged pump bearings	See your Polaris dealer

# POLARIS PRODUCTS

<b>Oil and Lubricants</b>	
Premium Gold Synthetic 2-Cycle Oil	
Quart	2871721
Gallon	2871722
VES II Synthetic 2-Cycle Oil	
Quart	2874438
Gallon	2874439
2.5 Gallon	2874443
Nature Oil Biodegradable 2-Cycle Oil	
Gallon	2872607
<b>Fuel System Maintenance Products</b>	
Carbon Clean Plus	2871326
Isopropyl Fuel De-Icer	2870505
Premium Fuel Stabilizer	2870652
<b>Grease</b>	
Grease Gun Kit	2871312
All Season Premium Grease	
3 oz. / 4 pack	2871322
14 oz. Tube	2871423
Starter Grease	2871460
Nyogel Grease	2871329

<b>General Maintenance Products</b>	
Fogging Oil	
12 oz. Aerosol	2870791
Quart	2871517
Carb & Throttle Body Cleaner	2872890
Multi-Purpose Lubricant	2872891
Electrical Contact Cleaner	2872892
Engine Degreaser	2872893
Revival / Detailing Kit	2871589
Restore Polish / Swirl and Scuff Remover	2871966
Finish Wax	2871965
Vinyl and Rubber Protectant	2871964
T 9 Metal Protectant (waterproof lube)	2871064
Battery Tender™ Battery Charger	2873261
<b>Retaining / Sealing Products</b>	
Loctite™ Products	
Threadlock 242	2871950
Threadlock 262	2871952
Threadlock 271	2871954
Loctite™ 518	2871961
Marine-Grade Silicone	8560054

# SPECIFICATIONS

CAPACITIES / DIMENSIONS	
Fuel Tank	17.8 gal. (67.4 l)
Oil Reservoir	6.0 gal. (5.68 l)
Rider Capacity	1-3 people
Rider Weight Limit (total)	500 lbs. (227 kg)
Total Weight Capacity	565 lbs. (256 kg)
Length	126 in. (320 cm)
Width	48.3 in. (122.6 cm)
Height	42.5 in. (108 cm)
Dry Weight	685 lbs. (311 kg)
Hull Material	Fiberglass Reinforced Composite
ELECTRICAL	
Alternator Output	12 amp/ 160watt @ 4500 rpm
Spark Plug Type	NGK PZFR6H
Spark Plug Gap	.028" +/- .002" (.71 mm +/- .05 mm)
Starting System	Electric Starter
Battery	12V, 19A

ENGINE	
Engine Type	Polaris Marine 1200 HO DI
Induction Type	Case Reed
Exhaust System	New Tuned Pipe/Water Cooled
Lubrication	Oil Injected
Sound Reduction	PLANET™
Oil Type	TC-W3 or Synthetic 2-Cycle Oil
Cylinders	3
Bore x Stroke	85 mm x 70 mm
Displacement	1192
Rated Horsepower	140
RPM Limiter Operation	7200
Ignition System	FICHT™ EMM
COOLING	
Engine Cooling	Water cooled, thermostat pop off
Overheat Warning	Warning Light/RPM Limit
FUEL DELIVERY	
Fuel Type	87 Octane Non-oxygenated or 89 Octane Oxygenated
Fuel Delivery	3 Ram Injectors
Intake Type	Reed Valve



# SPECIFICATIONS

PROPULSION	
Impeller, Stainless Steel	3 Blade, Progressive Pitch, Radial Blade
Propulsion	Jet Drive
Jet Pump Type	Dominator, Single Stage Axial Flow, Six Vane Stainless Steel Stator
Transmission	Direct Drive
Reverse System	Standard
Impeller Diameter	5.83 in. (148 mm)

FEATURES	
Instrumentation	New Generation Instrument (NGI)
Ski Tow Hook, Stainless Steel	Standard
Throttle	Finger Trigger/Reversible
Mirrors	Standard
Bilge Pump	Siphon
Sponsons	Matrix Blade
Footwell Pads	Hydro-Turf™
Seat	Single
Child Grab Handle	Standard
Accessories	MSX Knee Pads, Tow Pylon

# WARRANTY

## Obtaining Service and Warranty Assistance

Read carefully and understand the service data and the Polaris Warranty contained in this manual. Contact your Polaris dealer in matters pertaining to replacement parts, service, or warranty. Your dealer is constantly kept up-to-date on changes, modifications, and tips on personal watercraft maintenance that may supersede information contained in this manual. Your dealer is familiar with Polaris policies and procedures and will be happy to assist you.

When inquiring about parts, service, or warranty, always include the following information:

1. Serial number
2. Model number
3. Dealer name
4. Date of purchase
5. Details of trouble experienced
6. Length of time and conditions of operation
7. Indicate previous correspondence

## LIMITED WARRANTY

Polaris Industries Inc., 2100 Highway 55, Medina, MN 55340, gives a ONE YEAR LIMITED WARRANTY on all components of the Polaris personal watercraft against defects in material or workmanship. This warranty covers the parts and labor charges for repair or replacement of defective parts which are covered by this warranty. This warranty begins on the date of purchase. This warranty is transferrable to another consumer during the warranty period through a Polaris dealer.

## REGISTRATION

At the time of sale, the Warranty Registration Form must be completed by your dealer and submitted to Polaris within ten days. Upon receipt of this registration, Polaris will record the registration for warranty. No verification of registration will be sent to the purchaser as the copy of the Warranty Registration Form will be the warranty entitlement. If you have not signed the original registration and received the “customer copy”, please contact your dealer immediately. **NO WARRANTY COVERAGE WILL BE ALLOWED UNLESS YOUR PERSONAL WATERCRAFT IS REGISTERED WITH POLARIS AND YOU HAVE CONFIRMED THAT YOU HAVE WATCHED THE SAFETY AND OPERATION VIDEO AND REVIEWED THE SUMMARY TRAINING POINTS.**

Initial dealer preparation and set-up of your personal watercraft is very important in ensuring trouble-free operation. Purchasing a machine in the crate or without proper dealer set-up will void your warranty coverage.

# WARRANTY

## WARRANTY COVERAGE AND EXCLUSIONS:

### Limitations of Warranties and Remedies

This Polaris limited warranty covers all parts and components except for impeller damage caused by ingestion of rocks, sand, or gravel or any other damage caused by operation in shallow water. The warranty also excludes any other failures that are not caused by a defect in material or workmanship.

### Warranty Policy

This warranty does not cover accidental damage, normal wear and tear, abuse or improper handling. This warranty also does not cover any personal watercraft that has been altered structurally, modified, neglected, improperly maintained, used for racing, or used for purposes other than for which it was manufactured, or for any damages which occur during trailer transit or as a result of unauthorized service or the use of unauthorized parts. In addition, this warranty does not cover physical damage to paint or finish, gel coat stress cracks, tearing or puncturing of upholstery material, corrosion, or defects in parts, components or personal watercraft due to fire, explosions or any other cause beyond Polaris' control.

This warranty does not cover the use of unauthorized lubricants, chemicals, or fuels that are not compatible with watercraft. In addition this warranty does not cover stress cracks, submersion, or growth of marine organisms on hull and deck.

The exclusive remedy for breach of this warranty shall be, at Polaris' exclusive option, repair or replacement of any defective materials, or components or products. THE REMEDIES SET FORTH IN THIS WARRANTY ARE THE ONLY REMEDIES AVAILABLE TO ANY PERSON FOR BREACH OF THIS WARRANTY. POLARIS

SHALL HAVE NO LIABILITY TO ANY PERSON FOR INCIDENTAL, CONSEQUENTIAL OR SPECIAL DAMAGES OF ANY DESCRIPTION, WHETHER ARISING OUT OF EXPRESS OR IMPLIED WARRANTY OR ANY OTHER CONTRACT, NEGLIGENCE, OR OTHER TORT OR OTHERWISE. Some states do not permit the exclusion or limitation of incidental or consequential damages or implied warranties, so the above limitations or exclusions may not apply to you if inconsistent with controlling state law.

ALL IMPLIED WARRANTIES (INCLUDING BUT NOT LIMITED TO THE IMPLIED WARRANTIES OF MERCHANTABILITY AND FITNESS FOR A PARTICULAR PURPOSE) ARE LIMITED IN DURATION TO THE ABOVE ONE YEAR WARRANTY PERIOD. POLARIS FURTHER DISCLAIMS ALL EXPRESS WARRANTIES NOT STATED IN THIS WARRANTY. Some states do not allow limitations on how long an implied warranty lasts, so the above limitation may not apply to you if inconsistent with controlling state law.

# WARRANTY

## HOW TO OBTAIN WARRANTY SERVICE

If your personal watercraft requires warranty service, it must be taken to a Polaris dealer authorized to repair Polaris personal watercraft. When requesting warranty service you must present your copy of the Warranty Registration form to the dealer. (The cost of transportation to and from the dealer is your responsibility.) Polaris suggests that you use your original selling dealer; however, you may use any Polaris Servicing Dealer to perform warranty service.

Please work with your dealer to resolve any warranty issues. Should your dealer require any additional assistance they will contact the appropriate personnel at Polaris.

This warranty gives you specific legal rights, and you may also have other rights which vary from state to state.

If any of the above terms are void because of state or federal law, all other warranty terms will remain in effect.

## Engine Oil

1. Mixing oil brands or using non-recommended oil may cause engine damage. We recommend the use of Polaris engine oils for your Polaris vehicle.
2. Damage resulting from the use of non-recommended lubricants may not be covered by warranty.

Polaris warrants to the ultimate purchaser and each subsequent purchaser that this engine is designed, built, and equipped to conform at the time of sale with applicable regulations under section 213 of the Clean Air Act. Polaris warrants that this engine is free from defects in materials and workmanship that would cause the engine to fail to conform with applicable regulations for the U.S. EPA emission warranty period, which is one (1) year from the date of purchase for the emission-related components in this engine.

# CALIFORNIA EMISSION CONTROL SYSTEM LIMITED WARRANTY

## POLARIS WATERCRAFT ENGINES YOUR WARRANTY RIGHTS AND OBLIGATIONS

The California Air Resources Board and Polaris Industries, Inc. (Polaris) are pleased to explain the California emission control system limited warranty on your Model Year 2002 or later Polaris watercraft engine. In California, new watercraft engines must be designed, built and equipped to meet the State's stringent anti-smog standards. Polaris must warrant the emission control system on your watercraft engine for the periods of time listed below provided there has been no abuse, neglect, or improper maintenance of your watercraft engine.

Your emission control system includes the direct fuel injection system and the ignition system. Also included may be other emission-related assemblies as indicated in the list of warranted parts. Where a warrantable condition exists, Polaris will repair your watercraft engine at no cost to you, including diagnosis, parts, and labor. This includes diagnostic labor that is directly associated with a defective emission-related warranted part. The diagnosis and repair must be performed at an authorized Polaris dealer.

### MANUFACTURER'S WARRANTY COVERAGE:

Polaris warrants to the ultimate California purchaser and each subsequent California purchaser thereafter that this new watercraft engine sold in California to a California resident is:

- Designed, built, and equipped so as to conform, at the time of sale, to all applicable regulations adopted by the California Air Resources Board.

- Free from defects in material and workmanship that cause the failure of a warranted part to be identical in all material respects to that part as described in Polaris' application for certification. In practical terms, a defect exists when a deficiency in materials or workmanship causes an emission-related part to not function as designed.

The limited warranty begins on the date the watercraft is delivered to the ultimate California purchaser or, as in the case of a demonstration engine or watercraft, on the date it is first put in service. The warranty period of the watercraft engine will be 4 years or 250 hours of use, whichever occurs first.

Select emission control parts from model year 2002 and later watercraft engines are warranted for 4 years, or for 250 hours of use, or for the period prior to the first scheduled replacement of the warranted part as required by the maintenance schedule in the owner's manual or other written instructions provided by Polaris, whichever occurs first. However, warranty coverage based on the hourly period is only permitted for watercraft engines equipped with appropriate hour meters or their equivalent. The electronic engine management module in your watercraft engine contains a very accurate clock (i.e., hour meter) that accumulates engine run time. This clock will be used by Polaris to limit warranty coverage to 250 hours of use, within the first 4 years. Warranty coverage expires after 4 years, regardless of the hours of use. If any emission-related part is defective under warranty, the part will be repaired or replaced by Polaris.

# CALIFORNIA EMISSION CONTROL SYSTEM LIMITED WARRANTY

## OWNER'S WARRANTY RESPONSIBILITIES:

As the watercraft engine owner, you are responsible for performance of the required maintenance listed in your owner's manual. Polaris recommends that you retain all receipts covering maintenance on your watercraft engine, but Polaris cannot deny warranty coverage solely for lack of receipts or your failure to ensure the performance of all scheduled maintenance. As the watercraft engine owner, you should however be aware that Polaris may deny you warranty coverage if your watercraft engine or a part has failed due to abuse, neglect, improper maintenance, or unapproved modifications. Receipts and records pertaining to regular scheduled maintenance may be relevant in the event questions arise concerning maintenance. The receipts should be transferred to each subsequent owner of this watercraft.

You are responsible for presenting your watercraft engine to a Polaris authorized dealer as soon as a problem exists. Notice must be given to an authorized Polaris dealer of any apparent defect(s) within a reasonable time after discovery. The warranty repairs should be completed in a reasonable amount of time, not to exceed 30 days. It is recommended that any replacement part(s) used for maintenance, replacement, or repair of emission control systems be Polaris parts. Replacement parts equivalent to Polaris parts may be used in the performance of warranty repairs and will be provided without charge to the owner, and with no reduction in Polaris' warranty obligation. Use of parts that are not equivalent to Polaris parts which causes the warranted part(s) to fail may constitute abuse and/or improper service, thereby invalidating Polaris' warranty liability.

If you have any questions regarding your warranty rights and responsibilities, or to identify the nearest Polaris authorized dealer, you should contact Polaris at 1-800-POLARIS (1-800-765-2747).

# CALIFORNIA EMISSION CONTROL SYSTEM LIMITED WARRANTY

## WARRANTED PARTS:

### 1. Fuel Metering System

- Fuel injection system
- Cold start enrichment system
- Intake valves

### 2. Air Induction System

- Intake manifold
- Air filter

### 3. Ignition System

- Spark plugs
- Magneto or electronic ignition system
- Spark advance / retard system
- Ignition coil and/or control module
- Ignition wires

Note: The original spark plugs are warranted for the period of replacement indicated in the owner's manual and not for the warranty period of the watercraft engine.

### 4. Lubrication System

- Oil pump and internal parts

### 5. Exhaust System

### 6. Miscellaneous parts included in above systems

- Hoses, clamps, fittings, tubing, sealing, gaskets or devices, and mounting hardware
- Vacuum, temperature, check, and time sensitive valves and switches
- Electronic controls

7. Engine components with damage proximately caused by a failure under warranty of any warranted emission-related part.

## EXCLUSIONS:

This limited warranty is void if the direct cause of the need to repair or replace a warranted part is due to owner/operator abuse, neglect, improper maintenance, tampering, modification, misuse, alteration, or improper adjustment. Use of parts that are not equivalent to Polaris parts, improper service, or lack of required maintenance which causes the warranted part(s) to fail may constitute abuse and/or improper service, thereby invalidating warranty liability hereunder. In addition, the use of add-on or modified parts will be grounds for disallowing a warranty claim.

This limited warranty does not cover damage resulting from accidents, acts of nature, or other events or occurrences beyond Polaris' control. Polaris expressly disclaims responsibility for any and all consequential damages, such as loss of time, inconvenience, loss of use of the watercraft, or commercial loss.

# INDEX

## A

Accessories . . . . .	35
Age Restrictions . . . . .	6
Anti-corrosion Treatment . . . . .	72
Avoid Collisions . . . . .	55

## B

Battery . . . . .	46, 72, 86-89
Battery Charging . . . . .	88
Battery Fluid . . . . .	86
Battery Installation . . . . .	89
Battery Maintenance . . . . .	86
Battery Removal . . . . .	87
Battery Storage . . . . .	89
Beaching the Watercraft . . . . .	63
Before Starting the Engine . . . . .	57
Boarding in Deep Water . . . . .	59
Boarding the Watercraft . . . . .	59-60
Boarding With a Passenger . . . . .	60
Boating Under the Influence . . . . .	22
Break-In Procedure . . . . .	49-50
Buoys And Markers . . . . .	55

## C

Capsized Watercraft . . . . .	66
Cleaning . . . . .	94
Cooling System Flushing . . . . .	91
Crossing Paths . . . . .	53

## D

Daily Care . . . . .	68-69
Do Your Part . . . . .	5
Drain Plugs/Bilge . . . . .	47

## E

Electrical Shock Hazard . . . . .	21
EMISSIONS . . . . .	36-37
Encountering Vessels . . . . .	52
Engine and Exhaust System Draining . . . . .	92
Engine Compartment . . . . .	44
Engine Components . . . . .	28-29
Engine Doesn't Start . . . . .	58
Engine Fogging Procedure . . . . .	93
Engine Oil . . . . .	106
ENGINE TROUBLESHOOTING . . . . .	96-100
Engine Water Removal Procedure . . . . .	73
EPA Emissions Regulations . . . . .	36, 106
Extended Storage . . . . .	92-95

## F

FEATURES AND CONTROLS . . . . .	24-35
Fire Extinguisher . . . . .	45
Fire Safety . . . . .	17
Fishing Vessel Right-of-way . . . . .	54
Footwell Pads . . . . .	26
Fuel . . . . .	40-41
Fuses . . . . .	85

## G

General Maintenance . . . . .	74
Give-way . . . . .	51

## H

Hull . . . . .	47
Hypothermia . . . . .	23

## I

IDENTIFICATION NUMBERS . . . . .	7
Informational Decals . . . . .	13

## J

Jet Pump Intake . . . . .	43
Jet Pump Water Intake Safety . . . . .	21

## K

Know Your Vehicle . . . . .	5
-----------------------------	---

## L

Launch Ramp Etiquette . . . . .	55
Launching the Watercraft . . . . .	56
Lifting the Watercraft . . . . .	21
Loose Parts . . . . .	45
Lubrication . . . . .	79-80, 95

## M

MAINTENANCE/LUBRICATION . . . . .	74-95
Maintenance Requirements . . . . .	6
Meeting Vessels . . . . .	52



# INDEX

## N

Navigational Rules .....	51-55
New Generation Instrument .....	30-33
Non-motorized Craft .....	54

## O

Obstacles and Shallow Water .....	19
Oil .....	42
Operating in Rough Conditions .....	64
Operating With Passengers .....	67
OPERATION .....	38-73
Operator Awareness .....	22
Operator Fatigue and Dehydration .....	23
Operator Fitness .....	22
Operator Guidelines .....	14
Operator Safety .....	14-22
Overloading the Watercraft .....	17
Overtaking Vessels .....	53

## P

Periodic Maintenance Schedule .....	75-78
POLARIS PRODUCTS .....	101
Post Operation Maintenance .....	68-73
Pre-Operation Check .....	20
Pre-Operation Inspection .....	38-48
Principles of Operation .....	49
Protective Apparel .....	18

## R

Refueling .....	41
Riding Gear .....	47
Right-of-way .....	51
RPM Limiter .....	34
Rule 2 .....	52

## S

Safe Riding Gear .....	16
Safe Riding Position .....	21
SAFETY .....	8-23
Safety Decals .....	9-12
Safety Training .....	5
Salt Water and Unclean Water Care .....	90
Seat .....	45
Service and Maintenance .....	20
Signal Words and Symbols .....	8
Signal words and symbols .....	8
Spark Plugs .....	81-82
SPECIFICATIONS .....	102-103
Stand-on Vessel .....	51
Starting In Deep Water .....	59
Starting the Engine .....	57-58
Steering Cable .....	79
Steering Cable Inspection .....	85
Steering Inspection .....	44
Stopping the Watercraft .....	62

## S

Storage .....	70, 92-95
Storage Compartment .....	44
Submerged Engine .....	72
Switches/Buttons .....	48

## T

TABLE OF CONTENTS .....	4
Temporary Storage .....	70
Throttle Cable .....	79
Throttle Cable Inspection .....	85
Throttle Inspection .....	44
Towing .....	65
Transporting The Watercraft .....	71
Turning and Accelerating .....	20
Turning the Watercraft .....	61

## V

Vehicle Modifications .....	23
-----------------------------	----

## W

WARRANTY .....	104-106
Water Inlet Screen .....	90
Weather and Darkness .....	18
WELCOME .....	3

## Y

YOUR RESPONSIBILITIES .....	5-6
-----------------------------	-----

Read and understand all warning labels and Owner's Manual before operation. Severe injury or death can result from ignoring warnings or from improper use. Never permit a guest to operate this watercraft unless the guest has read and understands all warning labels and the Owner's Manual.

**THIS MANUAL SHOULD REMAIN WITH THE WATERCRAFT, IN ITS STORAGE BAG, AT ALL TIMES.**



**POLARIS**<sup>®</sup>  
The Way Out.

For your nearest Polaris dealer, call 1-800-POLARIS  
or visit [www.polarisindustries.com](http://www.polarisindustries.com)  
Polaris Sales Inc., 2100 Hwy. 55, Medina, MN 55340  
Phone (763) 542-0500 Fax (763) 542-0599  
Part No. 9918124  
Printed in USA

## Free Manuals Download Website

<http://myh66.com>

<http://usermanuals.us>

<http://www.somanuals.com>

<http://www.4manuals.cc>

<http://www.manual-lib.com>

<http://www.404manual.com>

<http://www.luxmanual.com>

<http://aubethermostatmanual.com>

Golf course search by state

<http://golfingnear.com>

Email search by domain

<http://emailbydomain.com>

Auto manuals search

<http://auto.somanuals.com>

TV manuals search

<http://tv.somanuals.com>