

# WELCOME

Thank you for purchasing a Polaris vehicle, and welcome to our world-wide family of Polaris owners. We proudly produce an exciting line of utility and recreational products.

- Snowmobiles
- All-terrain vehicles (ATVs)
- *RANGER* utility vehicles
- Victory motorcycles

We believe Polaris sets a standard of excellence for all utility and recreational vehicles manufactured in the world today. Many years of experience have gone into the engineering, design, and development of your Polaris vehicle, making it the finest machine we've ever produced.

For safe and enjoyable operation of your vehicle, be sure to follow the instructions and recommendations in this owner's manual. Your manual contains instructions for minor maintenance, but information about major repairs is outlined in the Polaris Service Manual and should be performed only by a Factory Certified Master Service Dealer (MSD) Technician.

Your Polaris dealer knows your vehicle best and is interested in your total satisfaction. Be sure to return to your dealership for all of your service needs during, and after, the warranty period.

We also take great pride in our complete line of apparel, parts and accessories, available through our online store at [www.purepolaris.com](http://www.purepolaris.com). Have your accessories and clothing delivered right to your door!



POLARIS and POLARIS THE WAY OUT are registered trademarks of Polaris Industries Inc.

Copyright 2007 Polaris Sales Inc. All information contained within this publication is based on the latest product information at the time of publication. Due to constant improvements in the design and quality of production components, some minor discrepancies may result between the actual vehicle and the information presented in this publication. Depictions and/or procedures in this publication are intended for reference use only. No liability can be accepted for omissions or inaccuracies. Any reprinting or reuse of the depictions and/or procedures contained within, whether whole or in part, is expressly prohibited.

Printed in U.S.A.

2008 Sportsman 400 Owner's Manual

P/N 9921344

# TABLE OF CONTENTS

<b>Know Your Vehicle</b> . . . . .	<b>5</b>
<b>Safety</b> . . . . .	<b>6</b>
<b>Features and Controls</b> . . . . .	<b>34</b>
<b>Operation</b> . . . . .	<b>46</b>
<b>Emission Control Systems</b> . . . . .	<b>67</b>
<b>Maintenance</b> . . . . .	<b>68</b>
<b>Adjustments</b> . . . . .	<b>117</b>
<b>Polaris Products</b> . . . . .	<b>121</b>
<b>Troubleshooting</b> . . . . .	<b>122</b>
<b>Specifications</b> . . . . .	<b>126</b>
<b>Warranty</b> . . . . .	<b>128</b>
<b>Maintenance Log</b> . . . . .	<b>134</b>
<b>Index</b> . . . . .	<b>136</b>



# KNOW YOUR VEHICLE

As the operator of the vehicle, you are responsible for your personal safety, the safety of others, and the protection of our environment. Read and understand your owner's manual, which includes valuable information about all aspects of your vehicle, including safe operating procedures.

## Vehicle Identification Numbers

Record your vehicle's identification numbers and key number in the spaces provided. Remove the spare key and store it in a safe place. An ignition key can be duplicated only by ordering a Polaris key blank (using your key number) and mating it with one of your existing keys. The ignition switch must be replaced if all keys are lost.

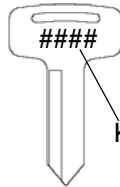
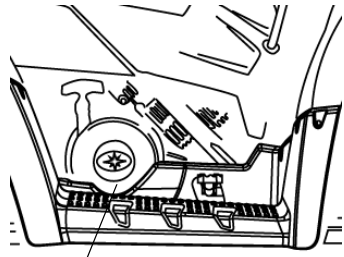
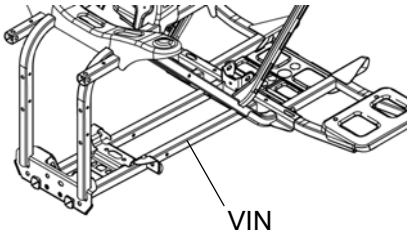

Vehicle Model Number: \_\_\_\_\_

Frame VIN: \_\_\_\_\_

Engine Serial Number: \_\_\_\_\_

Key Number: \_\_\_\_\_

# SAFETY

## Safety Decals and Locations

Warning decals have been placed on the ATV for your protection. Read and follow the instructions of the decals on the ATV carefully. If any of the decals depicted in this manual differ from the decals on your ATV, always read and follow the instructions of the decals on the ATV.

If any decal becomes illegible or comes off, contact your Polaris dealer to purchase a replacement. Replacement *safety* decals are provided by Polaris at no charge.

### General Warning

#### WARNING

Improper ATV use can result in  
**SEVERE INJURY or DEATH**

**ALWAYS USE AN APPROVED  
HELMET AND PROTECTIVE  
GEAR**

**NEVER USE ON PUBLIC ROADS**

**NEVER CARRY PASSENGERS**

**NEVER USE WITH DRUGS OR  
ALCOHOL**

**NEVER operate:**

- without proper training or instruction
- at speeds too fast for your skills or the conditions
- on public roads - a collision can occur with another vehicle
- with a passenger - passengers affect balance and steering and increase risk of losing control

**ALWAYS:**

- use proper riding techniques to avoid vehicle overturns on hills and rough terrain and in turns
- avoid paved surfaces - pavement may seriously affect handling and control

**LOCATE AND READ OWNER'S MANUAL.**

**FOLLOW ALL INSTRUCTIONS AND WARNINGS.**

**IF OWNER'S MANUAL IS MISSING, CONTACT A POLARIS DEALER FOR A REPLACEMENT.**

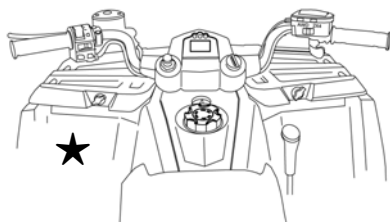

7172560

## Safety Decals and Locations Discretionary Warning

### WARNING

- Never operate this ATV on HILLS steeper than 25 degrees  $\leq 25^\circ$ . To prevent flip-over on hilly terrain, when going up or down, use throttle and brakes gradually.
- REVERSE operation can be dangerous even at low speeds. Steering becomes difficult. To prevent flipover, avoid sudden braking or sharp turns.
- Use OVERRIDE for reverse speed limiter with caution. To prevent loss of control, never activate override button with open throttle.
- PARKING BRAKE may relax when used for more than 5 minutes. When parking on grades, leave shift in forward.

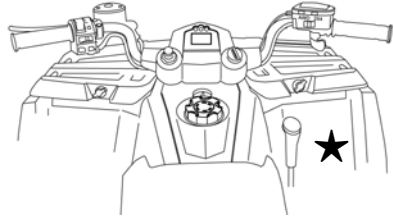

7172665

## Tire Pressure/Load Warning

### WARNING

IMPROPER TIRE PRESSURE OR OVERLOADING can cause loss of control resulting in SEVERE INJURY OR DEATH.

**TIRE PRESSURE IN PSI (KPa):** FRONT 5 (34.5) REAR 5 (34.5)

**MAXIMUM WEIGHT CAPACITY** 365 LBS. (166 KG)

INCLUDES WEIGHT OF OPERATOR, CARGO, AND ACCESSORIES

Reduce speed and allow greater distance for braking when carrying cargo. Overloading or carrying tall, off-center, or unsecured loads will increase your risk of losing control. Loads should be centered, carried as low as possible, and firmly secured to the racks. With dual racks, load distribution 1/3 front 2/3 rear is best. For stability on rough or hilly terrain, reduce speed and cargo. Do not block headlight. Be careful if load extends over the side of the rack.

Read Owner's Manual for more detailed loading information.

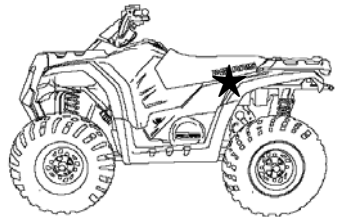

# SAFETY

## Safety Decals and Locations

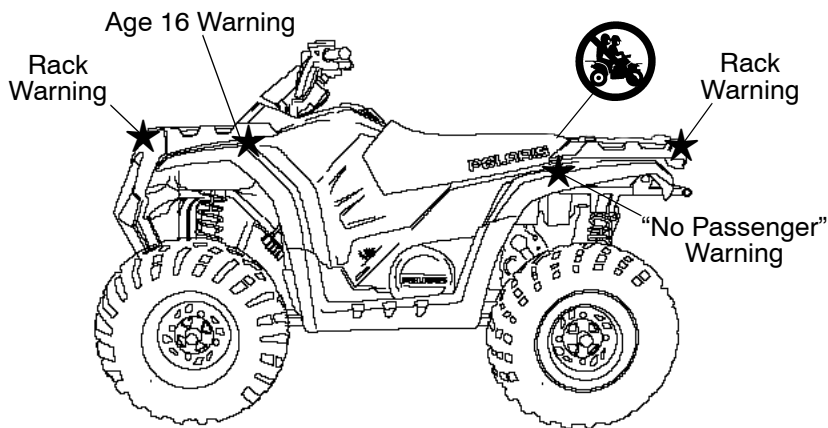

### **“No Passenger” Warning**

WARNING

NEVER ride as a passenger.

Passengers can cause a loss of control, resulting in SEVERE INJURY or DEATH.

7172566

### **Age 16 Warning**

WARNING

Operating this ATV if you are under the age of 16 increases your chance of severe injury or death.

NEVER operate this ATV if you are under age 16.

7172559



## Safety Decals and Locations Rack Warning, Front and Rear

### WARNING

- DO NOT TOW FROM RACK OR BUMPER. Vehicle damage or tipover may result causing severe injury or death. Tow only from tow hooks or hitch.
- Max Rack Loads: Front 70 lbs. (32 kg) Rear 100 lbs. (46 kg)

7173740

## Reverse Override Warning

### WARNING

Pushing reverse override button may cause sudden increases in power and traction if too much throttle is applied. Loss of control or forward flipover may result, especially in AWD. See Owner's Manual.

7172564

## All Wheel Drive Switch

Do not push switch to engage AWD if the rear wheels are spinning. This may cause severe drive shaft and clutch damage. See your Owner's Manual.

7079780

## Hitch Capacity Label

TRAILER MAX WEIGHT:

750 LBS. (340 KG) ON LEVEL GROUND

HITCH MAX. VERTICAL WEIGHT: 75 LBS. (34 KG)

7173739

# SAFETY

## Safe Riding Gear

Always wear appropriate clothing when riding an ATV. Wear protective clothing for comfort and to reduce the chance of injury.

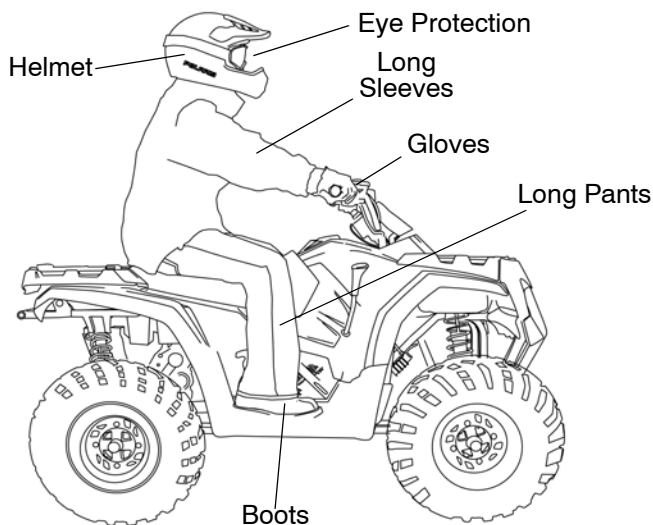

### Helmet

Wearing a helmet can prevent a severe head injury. Whenever riding a Polaris vehicle, always wear a helmet that meets or exceeds established safety standards.

Approved helmets in the USA and Canada bear a U.S. Department of Transportation (DOT) label.

Approved helmets in Europe, Asia and Oceania bear the ECE 22.05 label. The ECE mark consists of a circle surrounding the letter E, followed by the distinguishing number of the country which has granted approval. The approval number and serial number will also be displayed on the label.

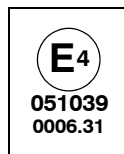

## Safe Riding Gear

### Eye Protection

Do not depend on eyeglasses or sunglasses for eye protection. When ever riding a Polaris vehicle, always wear shatterproof goggles or use a shatterproof helmet face shield. Polaris recommends wearing approved Personal Protective Equipment (PPE) bearing markings such as VESC 8, V-8, Z87.1, or CE. Make sure protective eye wear is kept clean.

### Gloves

Off-road style gloves with knuckle pads are the best for comfort and protection.

### Boots

The best footwear is a pair of sturdy over-the-calf boots with low heels.

### Clothing

Always wear long sleeves and long pants to protect arms and legs. Riding pants with kneepads and a jersey with shoulder pads provide the best protection.

# SAFETY

## Operator Safety

### **WARNING**

Failure to follow the warnings contained in this manual can result in severe injury or death.

A Polaris ATV is not a toy and can be hazardous to operate. This vehicle handles differently than other vehicles, such as motorcycles and cars. A collision or rollover can occur quickly, even during routine maneuvers like turning, or driving on hills or over obstacles, if you fail to take proper precautions.

Read and understand your owner's manual and all warnings before operating a Polaris ATV.

### **Age Restrictions**

This vehicle is an **ADULT VEHICLE ONLY**. Operation is prohibited for anyone under 16 years of age.

## Operator Safety Safety Training

ATV safety training is a top priority for Polaris. When you purchased your new ATV, your dealer instructed you on the authorized ATV *RiderCourse*<sup>sm</sup> available to you and your eligible family members. This training is included in the purchase price of your ATV. Polaris strongly encourages you and your eligible family members who will be riding the ATV to take the ATV *RiderCourse*<sup>sm</sup>. You were also provided with printed materials that explain safe operating procedures. You should review this information on a regular basis.

If you purchased a used Polaris ATV, you can take the ATV *RiderCourse*<sup>sm</sup> by calling ATV Enrollment Express at (800) 887-2887 or by visiting [www.atvsafety.org](http://www.atvsafety.org). Purchasers of a used Polaris ATV will be charged for this training.

A Polaris ATV is an off-road vehicle. Familiarize yourself with all laws and regulations concerning the operation of this vehicle in your area.

We strongly advise you to strictly follow the recommended maintenance program outlined in your owner's manual. This preventive maintenance program is designed to ensure that all critical components on your vehicle are thoroughly inspected at specific intervals.

# SAFETY

## Operator Safety

The following signal words and symbols appear throughout this manual and on your vehicle. Your safety is involved when these words and symbols are used. Become familiar with their meanings before reading the manual.



The *safety alert symbol*, on your vehicle or in this manual, alerts you to the potential for injury.

### **WARNING**

The *safety alert warning* indicates a potential hazard that may result in serious injury or death.

### **CAUTION**

The *safety alert caution* indicates a potential hazard that may result in minor injury or damage to the vehicle.

### **CAUTION**

A *caution* indicates a situation that may result in damage to the vehicle.

### **NOTE**

A *note* will alert you to important information or instructions.

## Operator Safety

### **WARNING**

Serious injury or death can result if you do not follow these instructions and procedures, which are outlined in further detail within your owner's manual.

- Read this manual and all labels carefully, and follow the operating procedures described.
- Never operate an ATV without proper instruction. Take a training course. Purchasers of a new Polaris ATV and their eligible family members are entitled to take the ATV *RiderCourse*<sup>sm</sup>. Contact ATV Enrollment Express at (800) 887-2887 or visit [www.atvsafety.org](http://www.atvsafety.org) for information on enrollment in the ATV *RiderCourse*<sup>sm</sup>.
- Never allow anyone under 16 years of age to operate this ATV.
- Never permit a guest to operate the ATV unless the guest has read this manual and all product labels and has completed a certified safety training course.
- Always avoid operating an ATV on paved surfaces, including sidewalks, driveways, parking lots, and streets.
- Never operate an ATV on a public street, road or highway, including a dirt or gravel road.
- Never operate an ATV without wearing an approved helmet that fits properly. Always wear eye protection (goggles or face shield), gloves, boots, a long-sleeved shirt or jacket, and long pants.
- Never consume alcohol or drugs before or while operating an ATV.
- Never operate at excessive speeds. Travel at speeds appropriate for the terrain, visibility and operating conditions, and your experience.
- Never attempt wheelies, jumps or other stunts.
- Always inspect your ATV before each use to make sure it's in safe operating condition. Always follow the inspection and maintenance procedures and schedules outlined in your owner's manual.
- Always keep both hands on the handlebars and both feet on the foot-rests of the ATV during operation.

# SAFETY

## Operator Safety

- Always travel slowly and use extra caution when operating on unfamiliar terrain. Be alert to changing terrain conditions.
- Never operate on excessively rough, slippery, or loose terrain.
- Always follow proper turning procedures as described in this manual. Practice turning at low speeds before attempting to turn at faster speeds. Do not turn at excessive speeds.
- Always have the ATV inspected by an authorized Polaris dealer if it's been involved in an accident.
- Never operate on hills too steep for the ATV or for your abilities. Practice on smaller hills before attempting larger hills.
- Always follow proper procedures for climbing hills. Check the terrain carefully before ascending a hill. Never climb hills with excessively slippery or loose surfaces. Shift your weight uphill. Never open the throttle suddenly or make sudden gear changes. Never go over the top of a hill at high speed.
- Always follow proper procedures for going downhill and for braking on hills. Check the terrain carefully before you start down a hill. Shift your weight uphill. Never go down a hill at high speed. Avoid going down a hill at an angle, which would cause the vehicle to lean sharply to one side. Drive straight downhill.
- Always follow proper procedures for crossing the side of a hill. Avoid hills with excessively slippery or loose surfaces. Shift your weight uphill. Never attempt to turn the ATV around on any hill until you've mastered (on level ground) the turning technique outlined in this manual. Avoid crossing the side of a steep hill when possible.
- Always use proper procedures if you stall or roll backwards while climbing a hill. To avoid stalling, maintain a steady speed when climbing a hill. If you stall or roll backwards, follow the special procedure for braking described in this manual. Always dismount on the uphill side, or to either side if the ATV is pointed straight uphill. Turn the ATV around and remount following the procedure described in this manual.



## Operator Safety

- Always check for obstacles before operating in a new area. Never attempt to operate over large obstacles, such as rocks or fallen trees. Always follow proper procedures when operating over obstacles as described in this manual.
- Always be careful of skidding or sliding. On slippery surfaces like ice, travel slowly and use extra caution to reduce the chance of skidding or sliding out of control.
- Avoid operating the ATV through deep or fast-flowing water. If it's unavoidable, travel slowly, balance your weight carefully, avoid sudden movements, and maintain a slow and steady forward motion. Do not make sudden turns or stops, and do not make sudden throttle changes.
- Wet brakes may have reduced stopping ability. Test the brakes after leaving water. If necessary, apply them lightly several times to allow friction to dry out the pads.
- Always check for obstacles or people behind the ATV before operating in reverse. When it's safe to proceed in reverse, move slowly and avoid turning at sharp angles.
- Always use the size and type of tires specified for your ATV, and always maintain proper tire pressure.
- Never modify an ATV through improper installation or use of accessories.
- Never exceed the stated load capacity for your ATV. Cargo must be properly distributed and securely attached. Reduce speed and follow the instructions in this manual for carrying cargo or towing. Allow a greater distance for braking.

# SAFETY

## Operator Safety

**FOR MORE INFORMATION ABOUT ATV SAFETY, call the Consumer Product Safety Commission at 1-800-638-2772, or visit [www.cpsc.gov](http://www.cpsc.gov), visit [www.atvsafety.org](http://www.atvsafety.org), or call Polaris at 1-800-342-3764.**

## Equipment Modifications

We are concerned for the safety of our customers and for the general public. Therefore, we strongly recommend that consumers do not install on a Polaris ATV any equipment that may increase the speed or power of the vehicle, or make any other modifications to the vehicle for these purposes. Any modifications to the original equipment of the vehicle create a substantial safety hazard and increase the risk of bodily injury.

The warranty on your Polaris ATV is terminated if any equipment has been added to the vehicle, or if any modifications have been made to the vehicle, that increase its speed or power.

**NOTE:** The addition of certain accessories, including (but not limited to) mowers, blades, tires, sprayers, or large racks, may change the handling characteristics of the vehicle. Use only Polaris-approved accessories, and familiarize yourself with their function and effect on the vehicle.

## Operator Safety

### ▲ WARNING

#### POTENTIAL HAZARD

Operating this ATV without proper instruction.

#### WHAT CAN HAPPEN

The risk of an accident is greatly increased if the operator does not know how to operate the ATV properly in different situations and on different types of terrain.

#### HOW TO AVOID THE HAZARD

Beginning and inexperienced operators should complete the *ATV RiderCourse*<sup>sm</sup> offered by Polaris through the SVIA. They should then regularly practice the skills learned in the course and the operating techniques described in the Owner's Manual.

For more information about the *ATV RiderCourse*<sup>sm</sup> contact ATV Enrollment Express at (800) 887-2887 or visit [www.atvsafety.org](http://www.atvsafety.org).

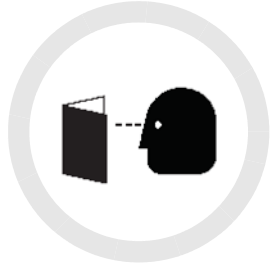

### ▲ WARNING

#### POTENTIAL HAZARD

Failure to follow the age recommendations for this ATV.

#### WHAT CAN HAPPEN

Severe injury and/or death could occur if a child under the minimum age recommendation operates an ATV.

Even though a child may be within the recommended age group for operating some ATVs, he/she may not have the skills, abilities, or judgment needed to operate an ATV safely and could be susceptible to accident or injury.

#### HOW TO AVOID THE HAZARD

No one under the age of 16 should operate a Polaris ATV.



# SAFETY

## Operator Safety

### WARNING

#### POTENTIAL HAZARD

Carrying a passenger on an ATV.

#### WHAT CAN HAPPEN

Carrying a passenger greatly reduces the operator's ability to balance and control the ATV, which could cause an accident and injury to the operator and/or passenger.

#### HOW TO AVOID THE HAZARD

Never carry a passenger. The purpose of the long seat is to allow the operator to shift position as needed during operation. It is not intended for carrying passengers.



### WARNING

#### POTENTIAL HAZARD

Operating an ATV on paved surfaces, including sidewalks, paths, parking lots, and driveways.

#### WHAT CAN HAPPEN

ATV tires are designed for off-road use. Operating on paved surfaces may adversely affect the handling of the ATV and could result in loss of control, accident, and/or injury.

#### HOW TO AVOID THE HAZARD

Avoid operating the ATV on pavement. If it's unavoidable, travel slowly and avoid sudden turns or stops.

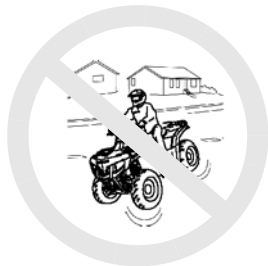

## Operator Safety

### **WARNING**

#### POTENTIAL HAZARD

Operating this ATV on public streets, roads or highways.

#### WHAT CAN HAPPEN

The ATV could collide with another vehicle.

#### HOW TO AVOID THE HAZARD

Never operate the ATV on any public street, road or highway, including dirt and gravel roads. In many states it's illegal to operate ATVs on public streets, roads and highways.



### **WARNING**

#### POTENTIAL HAZARD

Operating this ATV without wearing an approved helmet, eye protection and protective clothing.

#### WHAT CAN HAPPEN

Operating an ATV without an approved helmet increases the risk of a severe head injury or death in the event of an accident.

Operating without eye protection could result in an accident and could increase the chance of a severe injury in the event of an accident.

#### HOW TO AVOID THE HAZARD

Always wear an approved helmet that fits properly.

Always wear eye protection (goggles or face shield), gloves, boots, long-sleeved shirt or jacket, and long pants.

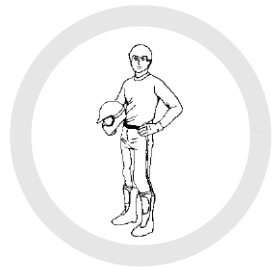

# SAFETY

## Operator Safety

### **⚠ WARNING**

#### POTENTIAL HAZARD

Operating the ATV after consuming alcohol or drugs.

#### WHAT CAN HAPPEN

Consumption of alcohol and/or drugs could seriously affect operator judgment. Reaction time may be slower and operator balance and perception could be affected.

Consuming alcohol and/or drugs before or while operating an ATV could result in an accident causing severe injury or death.

#### HOW TO AVOID THE HAZARD

Never consume alcohol or drugs before or while operating an ATV.



### **⚠ WARNING**

#### POTENTIAL HAZARD

Operating the ATV at excessive speeds.

#### WHAT CAN HAPPEN

Excessive speed increases the operator's chance of losing control of the ATV, which can result in an accident causing severe injury or death.

#### HOW TO AVOID THE HAZARD

Always operate the ATV at a speed that's proper for the terrain, visibility and operating conditions, and your experience.



## Operator Safety

### **WARNING**

#### POTENTIAL HAZARD

Attempting wheelies, jumps and other stunts.

#### WHAT CAN HAPPEN

Attempting stunts increases the chance of an accident, including an overturn.

#### HOW TO AVOID THE HAZARD

Never attempt wheelies, jumps, or other stunts. Avoid exhibition driving.



### **WARNING**

#### POTENTIAL HAZARD

Failure to inspect the ATV before operating.

Failure to properly maintain the ATV.

#### WHAT CAN HAPPEN

Poor maintenance increases the possibility of an accident or equipment damage.

#### HOW TO AVOID THE HAZARD

Always inspect your ATV before each use to make sure it's in safe operating condition.

Always follow the inspection and maintenance procedures and schedules described in the owner's manual.

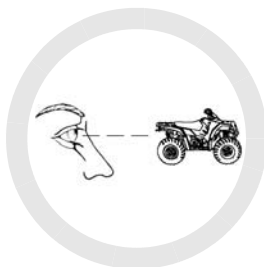

# SAFETY

## Operator Safety

### **▲ WARNING**

#### POTENTIAL HAZARD

Removing hands from the handlebars or feet from the footrests during operation.

#### WHAT CAN HAPPEN

Removing even one hand or foot can reduce ability to control the vehicle or could cause loss of balance and ejection from the ATV.

If the operator's foot is not firmly planted on the footrest, it could contact the rear wheels and lead to accident or injury.

#### HOW TO AVOID THE HAZARD

Always keep both hands on the handlebars and both feet on the footrests of the ATV during operation.



### **▲ WARNING**

#### POTENTIAL HAZARD

Failure to use extra caution when operating the ATV on unfamiliar terrain.

#### WHAT CAN HAPPEN

Unfamiliar terrain may contain hidden rocks, bumps, or holes that could cause loss of control or overturn.

#### HOW TO AVOID THE HAZARD

Travel slowly and use extra caution when operating on unfamiliar terrain. Always be alert to changing terrain conditions.





## Operator Safety

### **WARNING**

#### POTENTIAL HAZARD

Failure to use extra caution when operating on excessively rough, slippery or loose terrain.

#### WHAT CAN HAPPEN

Operating on excessively rough, slippery or loose terrain could cause loss of traction or loss of control, which could result in an accident or overturn.

#### HOW TO AVOID THE HAZARD

Do not operate on excessively rough, slippery or loose terrain until you've learned and practiced the skills necessary to control the ATV on such terrain. Always use extra caution on rough, slippery or loose terrain.



### **WARNING**

#### POTENTIAL HAZARD

Turning improperly.

#### WHAT CAN HAPPEN

Improper turns could cause loss of control and lead to a collision or overturn.

#### HOW TO AVOID THE HAZARD

Always follow proper procedures for turning as described in the owner's manual.

Practice turning at slow speeds before attempting to turn at faster speeds.

Never turn at excessive speed.



# SAFETY

## Operator Safety

### WARNING

#### POTENTIAL HAZARD

Operating on excessively steep hills.

#### WHAT CAN HAPPEN

The vehicle may overturn.

#### HOW TO AVOID THE HAZARD

Never operate on hills too steep for the ATV or for your abilities. Never operate the ATV on hills steeper than 25 degrees.



### WARNING

#### POTENTIAL HAZARD

Climbing hills improperly.

#### WHAT CAN HAPPEN

Improper hill climbing could cause loss of control or overturn.

#### HOW TO AVOID THE HAZARD

Always follow proper procedures for climbing hills as described in the owner's manual.

Always check the terrain carefully before ascending any hill.

Never operate the ATV on hills steeper than 25 degrees.

Never climb hills with excessively slippery or loose surfaces.

Shift your weight forward.

Never open the throttle suddenly while traveling uphill. The ATV could flip over backwards.

Never go over the top of any hill at high speed. An obstacle, a sharp drop, or another vehicle or person could be on the other side of the hill.

## Operator Safety

**▲ WARNING****POTENTIAL HAZARD**

Traveling downhill improperly.

**WHAT CAN HAPPEN**

Improperly descending a hill could cause loss of control or overturn.

**HOW TO AVOID THE HAZARD**

Always follow proper procedures for traveling down hills as described in the owner's manual. **NOTE:** A special technique is required when braking while traveling downhill. See page 59.

Always check the terrain carefully before descending a hill.

Shift your weight rearward.

Never travel down a hill at high speed.

Avoid traveling down a hill at an angle, which would cause the vehicle to lean sharply to one side. Travel straight down the hill when possible.

**▲ WARNING****POTENTIAL HAZARD**

Improperly crossing hills and turning on hills.

**WHAT CAN HAPPEN**

Improperly crossing or turning as hills could cause loss of control or overturn.

**HOW TO AVOID THE HAZARD**

Never attempt to turn the ATV around on any hill until you've mastered the turning technique (on level ground) as described in the owner's manual. See page 60. Use extra caution when turning on any hill.

Avoid crossing the side of a steep hill.

When crossing the side of a hill:

Always follow proper procedures as described in the owner's manual.

Avoid hills with excessively slippery or loose surfaces.

Shift your weight to the uphill side of the ATV.



# SAFETY

## Operator Safety

### WARNING

#### POTENTIAL HAZARD

Stalling, rolling backwards or improperly dismounting while climbing a hill.

#### WHAT CAN HAPPEN

The vehicle could overturn.

#### HOW TO AVOID THE HAZARD

Maintain steady speed when climbing a hill.

*If all forward speed is lost:*

Keep your weight uphill.

Apply the brakes.

Lock the parking brake when fully stopped.

*If the ATV begins rolling backwards:*

Keep weight uphill.

Never apply engine power.

Never apply the rear brake while rolling backwards.

Apply the single-lever brake gradually.

When fully stopped, apply the rear brake as well, and then lock the parking brake.

Dismount on uphill side, or to either side if ATV is pointed straight uphill.

Turn the ATV around and remount, following the procedure described in the owner's manual. See page 60.



## Operator Safety

### **WARNING**

#### POTENTIAL HAZARD

Improperly operating over obstacles.

#### WHAT CAN HAPPEN

Operating over obstacles could cause loss of control or overturn.

#### HOW TO AVOID THE HAZARD

Before operating in a new area, check for obstacles.

Avoid operating over large obstacles such as rocks and fallen trees when possible. If unavoidable, use extreme caution and always follow proper procedures as outlined in the owner's manual.

### **WARNING**

#### POTENTIAL HAZARD

Skidding or sliding.

#### WHAT CAN HAPPEN

Skidding or sliding can cause loss of control.

If the tires regain traction unexpectedly, the ATV could overturn.

#### HOW TO AVOID THE HAZARD

On slippery surfaces such as ice, travel slowly and use extra caution to reduce the chance of skidding or sliding out of control.

# SAFETY

## Operator Safety

### **⚠ WARNING**

#### POTENTIAL HAZARD

Operating the ATV through deep or fast-flowing water.

#### WHAT CAN HAPPEN

Tires may float, causing loss of traction and loss of control, which could lead to an accident or overturn.

#### HOW TO AVOID THE HAZARD

Avoid operating the ATV through deep or fast-flowing water. If it's unavoidable to enter water that exceeds the recommended maximum depth (see page 62), travel slowly, balance your weight carefully, avoid sudden movements, and maintain a slow and steady forward motion. Do not make sudden turns or stops, and do not make sudden throttle changes.

Wet brakes may have reduced stopping ability. Always test the brakes after leaving water. If necessary, apply them several times to let friction dry out the pads.



### **⚠ WARNING**

#### POTENTIAL HAZARD

Improperly operating in reverse.

#### WHAT CAN HAPPEN

The ATV could collide with an obstacle or person, resulting in severe injury.

#### HOW TO AVOID THE HAZARD

Before shifting into reverse gear, always check for obstacles or people behind the ATV. When it's safe to proceed, back slowly.

## Operator Safety

### **▲ WARNING**

#### POTENTIAL HAZARD

Operating this ATV with improper tires, or with improper or uneven tire pressure.

#### WHAT CAN HAPPEN

Use of improper tires, or operation of the ATV with improper or uneven tire pressure, could cause loss of control or accident.

#### HOW TO AVOID THE HAZARD

Always use the size and type of tires specified for the ATV in the owner's manual.

Always maintain proper tire pressure as described in the owner's manual and on safety decals.



### **▲ WARNING**

#### POTENTIAL HAZARD

Operating the ATV with improper modifications.

#### WHAT CAN HAPPEN

Improper installation of accessories or modification of the ATV may cause changes in handling, which could lead to an accident.

#### HOW TO AVOID THE HAZARD

Never modify the ATV through improper installation or use of accessories. All parts and accessories added to the vehicle must be genuine Polaris Industries Inc. or equivalent components designed for use on this ATV and should be installed and used according to approved instructions. See your authorized Polaris ATV dealer for more information.

# SAFETY

## Operator Safety

### **WARNING**

#### POTENTIAL HAZARD

Overloading the ATV or carrying/towing cargo improperly.

#### WHAT CAN HAPPEN

Overloading and towing can cause changes in vehicle handling, which could lead to loss of control or an accident.

#### HOW TO AVOID THE HAZARD

Never exceed the stated load capacity for this ATV.

Cargo should be properly distributed and securely attached.

Reduce speed when carrying cargo or pulling a trailer. Allow a greater distance for braking.

Always follow the instructions in the owner's manual for carrying cargo or pulling a trailer.

### **WARNING**

#### POTENTIAL HAZARD

Operating on frozen bodies of water.

#### WHAT CAN HAPPEN

Severe injury or death can result if the ATV and/or the operator fall through the ice.

#### HOW TO AVOID THE HAZARD

Never operate the ATV on a frozen body of water.



## Operator Safety

### **WARNING**

Operating a damaged ATV can result in an accident with serious injury or death. After any overturn or accident, have a qualified service dealer inspect the entire machine for possible damage, including (but not limited to) brakes, throttle and steering systems.

### **WARNING**

Safe operation of this rider-active vehicle requires good judgement and physical skills. Persons with cognitive or physical disabilities who operate this vehicle have an increased risk of overturn and loss of control, which could result in severe injury or death.

### **WARNING**

Exhaust system components are very hot during and after use of the vehicle. Hot components can cause serious burns and fire. Do not touch hot exhaust system components. Always keep combustible materials away from the exhaust system. Use caution when traveling through tall grass, especially dry grass.

### **WARNING**

Leaving the keys in the ignition can lead to unauthorized use of the vehicle resulting in serious injury or death. Always remove the ignition key when the vehicle is not in use.

# FEATURES AND CONTROLS

## Switches

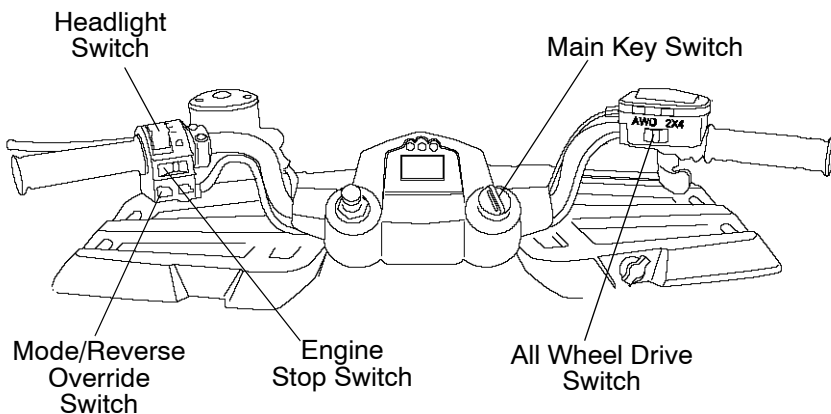

### **⚠ WARNING**

Activating the override switch while the throttle is open can cause loss of control, resulting in severe injury or death. Do not activate the override switch while the throttle is open.

### **Mode/Reverse Override Switch**

This vehicle is equipped with a reverse speed limiter system. To gain additional power while backing, depress the override switch.

**NOTE:** The override switch also allows activation of All Wheel Drive in reverse, if the AWD switch is on. This switch is also used to toggle through the modes of the rider information center. See page 44.

# FEATURES AND CONTROLS

## Switches

### Engine Stop Switch

Move the stop switch either left or right to the OFF position to stop the engine quickly. The engine will not start or run when the switch is off.

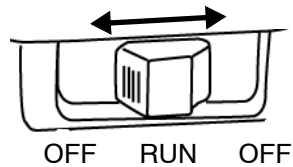

**NOTE:** Both the main switch and the engine stop switch will shut off all electrical power to the vehicle, including lights.

### Main Key Switch

Use the main key switch to start the engine. See page 50 for starting procedures.

### Headlight Switch

Use the headlight switch to turn the lights on and off and to change the lights from high beam to low beam.

**NOTE:** The lights won't work unless the key is in the ON position and the engine stop switch is in the RUN position.

## **⚠ WARNING**

Operating the ATV on streets or roads, especially in darkness, could result in an accident and serious injury or death.

Your ATV is not equipped with highway-approved lights. It's designed for and must be used for off-road use only. Use caution and drive at reduced speeds in conditions of reduced visibility such as fog, rain and darkness.

### All Wheel Drive Switch

See page 43 for all wheel drive information.

# FEATURES AND CONTROLS

## Throttle Lever

### **▲ WARNING**

Operating an ATV with sticking or improperly operating throttle controls could cause an accident and lead to severe injury or death.

Never start or operate an ATV with a sticking or improperly operating throttle. Always contact your dealer for service if throttle problems arise.

Failure to check or maintain proper operation of the throttle system can result in an accident if the throttle lever sticks during operation. Always check the lever for free movement and return before starting the engine. Also check occasionally during operation.

Engine speed and vehicle movement are controlled by pressing the throttle lever. The throttle lever is spring loaded. Engine speed returns to idle when the lever is released.

This ATV is equipped with Polaris Electronic Throttle Control (ETC), which is designed to reduce the risk of a frozen or stuck throttle. If the throttle cable should stick in an

open position when the operator releases the throttle lever, the engine will stop, and power to the rear wheels will cease.



### **▲ WARNING**

Modifications to the ETC could result in failure to perform as designed, which could result in severe injury or death. Do not attempt to modify the ETC system or replace it with any after market throttle mechanisms. Always ensure that the throttle cable is properly installed to the ETC.

# FEATURES AND CONTROLS

## Brake Lever

Squeeze the brake lever toward the handlebar to apply the front and rear brakes. These brakes are hydraulically activated disc type brakes that are activated by only one lever.

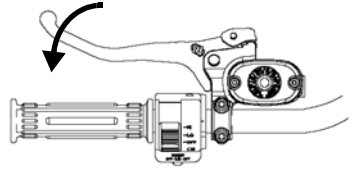

Always test brake lever travel and master cylinder fluid level before riding. When squeezed, the lever should feel firm. Any sponginess would indicate a possible fluid leak or low master cylinder fluid level, which must be corrected before riding. Contact your dealer for proper diagnosis and repairs.

### **⚠ WARNING**

Operating the ATV with a spongy brake lever can result in loss of braking, which could cause an accident. Never operate the ATV with a spongy-feeling brake lever.

# FEATURES AND CONTROLS

## Parking Brake

### **▲ WARNING**

Operating the ATV while the parking brake is engaged could result in an accident and serious injury or death. Always check to be sure the parking brake is disengaged before operating.

### **Locking the Parking Brake**

1. Place the transmission in gear.
2. Squeeze and release the brake lever two or three times, then squeeze and hold.
3. Push the parking brake lock forward to engage the lock.
4. Release the brake lever.
5. To release the parking brake lock, squeeze and release the brake lever. It will return to its unlocked position.

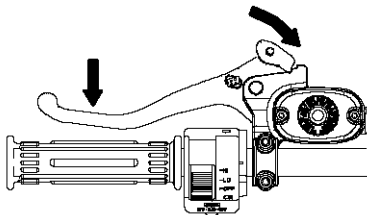

### **Important Safeguards**

- The parking brake may relax if left on for a long period of time. Always block the wheels to prevent rolling.
- Always block the wheels on the downhill side of the ATV if leaving it parked on a hill. Another option is to park the ATV in a sidehill position.
- Never depend on the parking brake alone if the ATV is parked on a hill. Always block the wheels to prevent rolling.

# FEATURES AND CONTROLS

## Auxiliary Foot Brake

The auxiliary brake system is intended to be used as a backup for the main brake system. Should the main system fail, use the auxiliary foot brake.

### **⚠ WARNING**

Aggressively applying the auxiliary brake when backing down a hill may cause rear tipover, which could result in serious injury or death.

Use caution when applying the auxiliary brake. Do not aggressively apply the auxiliary brake when going forward. The rear wheels may skid and slide sideways, causing loss of control and serious injury or death.

The auxiliary foot brake is located on the inside of the right footrest. Operate this brake with your right foot.

**NOTE:** If the rear wheels slide while using the auxiliary brake, *reduce* brake pedal pressure to brake the rear wheels without skidding.

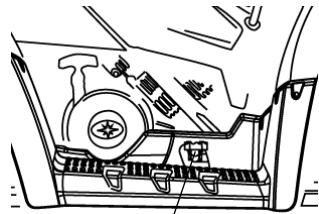

Auxiliary Foot Brake

Check the brake fluid level frequently for the auxiliary brake system. See page 87.

# FEATURES AND CONTROLS

## Choke

The choke assists in starting a cold engine. Refer to the engine starting procedure on page 50 for correct choke and throttle settings during starting.

## Fuel Tank Cap

Remove the fuel tank cap to add fuel to the fuel tank. Use either leaded or unleaded gasoline with a minimum pump octane number of 87=(R+ M/2) octane. *Do not use E-85 fuel.*

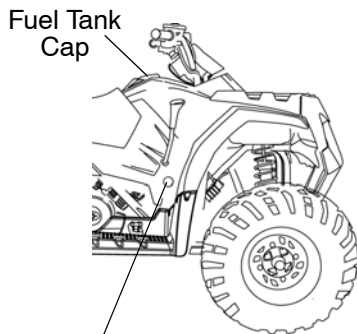

## Fuel Valve

The fuel valve is located on the bottom of the fuel tank. Access the fuel valve through the right side panel.

ON: For normal operation.

OFF: For vehicle storage and when transporting.

Refuel when the instrument gauge indicates a low fuel level.



ON



OFF

## Fuel Filter

The in-line fuel filter should be replaced by your dealer after every 100 hours of operation or annually. Do not attempt to clean the fuel filter.



# FEATURES AND CONTROLS

## Automatic Transmission Gear Selector

The transmission gear selector is located on the right side of the vehicle.

H: High Gear

N: Neutral

R: Reverse

Whenever the ATV is left unattended, always place the transmission in gear and lock the parking brake.

Gear  
Selector



### CAUTION

Shifting gears with the engine speed above idle or while the vehicle is moving could cause transmission damage.

To change gears, stop the vehicle, and with the engine idling, move the lever to the desired gear.

# FEATURES AND CONTROLS

## Recoil Starter

If the battery is too weak to start the engine, use the recoil starter. Follow the starting procedures on page 50, cranking the engine with the recoil starter instead of the main key switch.

1. Grasp the recoil starter rope handle tightly.
2. Pull slowly so you can feel the engine strokes.

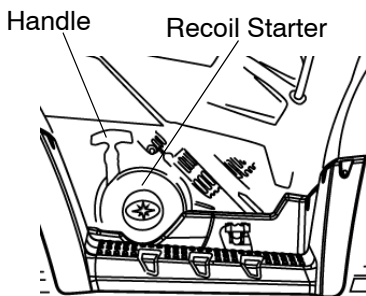

- NOTE:** The rope will be harder to pull when the engine is on a compression stroke. When a compression stroke is found, continue pulling the rope just until the engine rolls past the stroke, then stop pulling immediately.
3. Allow the recoil rope to rewind into the recoil assembly, then pull the rope abruptly and forcefully to start the engine.
  4. Repeat all steps until the engine starts.
  5. Make sure the handle is fully seated on the housing.

### CAUTION

Extending the recoil starter rope until it stops can cause damage to the recoil assembly. Do not extend the starter rope so far that it stops.

If the starter rope handle is not seated properly, water may enter the recoil housing and damage components. Make sure the handle is fully seated on the recoil housing, especially when traveling in wet areas.

# FEATURES AND CONTROLS

## All Wheel Drive (AWD) System

The All Wheel Drive system is controlled by the AWD switch. When the switch is on 2X4, the ATV is in two-wheel drive at all times. When the switch is on AWD, the ATV is in all wheel drive.

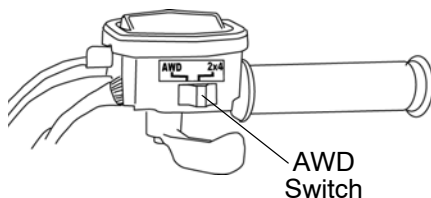

When in AWD, the demand drive unit will automatically engage any time the rear wheels lose traction. When the rear wheels regain traction, the demand drive unit will automatically disengage.

**NOTE:** The override switch allows activation of AWD in reverse if the AWD switch is on. See page 34.

There is no limit to the length of time the vehicle may remain in AWD.

### Engaging AWD

The AWD switch may be turned on or off while the vehicle is moving. Initially, the vehicle's electronic system will not enable the AWD until the engine RPM is below 3100. Once enabled, the AWD remains enabled until the AWD switch is turned off. If the switch is turned off while the demand drive unit is moving, it will not disengage until the rear wheels regain traction.

Engage the AWD switch before getting into conditions where front wheel drive may be needed. If the rear wheels are spinning, release the throttle before switching to AWD.

### CAUTION

Switching to AWD while the rear wheels are spinning may cause severe drive shaft and gearcase damage. Always switch to AWD while the rear wheels have traction or are at rest.

# FEATURES AND CONTROLS

## Instrument Cluster

Your ATV is equipped with an instrument cluster that senses vehicle speed from the right front wheel. The instrument cluster measures distance in miles as well as hours of operation. It also includes a reverse speed limiter function that limits the ATV's speed to approximately 7-9 mph. Refer to page 34 for additional information.

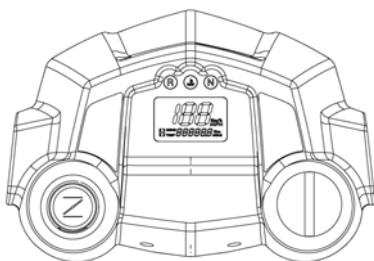

### CAUTION

High water pressure may damage ATV components. Wash the ATV by hand or with a garden hose using mild soap.

Certain products, including insect repellents and chemicals, will damage the speedometer lens and other plastic surfaces. Do not use alcohol to clean the instrument cluster. Do not allow insect sprays to contact the lens. Immediately clean off any gasoline that splashes on the instrument cluster.

## Miles/Kilometers Toggle

The display in the tripmeter, odometer and speedometer can be changed to display either kilometers or miles.

1. To change modes, press and release the mode button (see page 31) as often as needed to reach the odometer mode.
2. In the odometer mode, press and hold the mode button until the letters flash, then release the button.
3. Press and release the button one more time. When the display stops flashing, the mode has been set.

# FEATURES AND CONTROLS

## Instrument Cluster

### Rider Information Center

The rider information center is located in the instrument cluster. All segments will light up for 3 seconds at start-up.

1. **Gear Indicator** - This indicator displays gear shifter position.  
N = Neutral (Green)  
R = Reverse (Amber)
2. **Engine Hour Display Indicator**
3. **Speedometer**
4. **Odometer/Tripmeter/ Hour Meter**

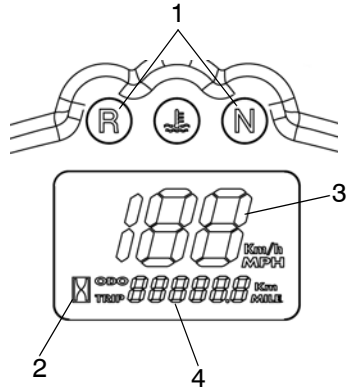

### Modes

Use the reverse override/mode button to toggle through the 3 standard modes.

**NOTE:** If using the mode button to program the rider information center, or to toggle through the options, the transmission cannot be in reverse.

### Odometer

The odometer records the distance traveled by the ATV.

### Trip Meter

The trip meter records the distance traveled by the ATV on each trip if it's reset before each trip. To reset the trip meter, toggle to the trip meter mode. Press and hold the mode button until the display changes to 0.

In the Rider Information Center, the trip meter display contains a decimal point, but the odometer displays without a decimal point.

### Hour Meter

This mode logs the total hours the engine has been in operation.

# OPERATION

## Fuel Safety

### **WARNING**

Gasoline is highly flammable and explosive under certain conditions.

- Always exercise extreme caution whenever handling gasoline.
- Always refuel with the engine stopped, and outdoors or in a well ventilated area.
- Do not smoke or allow open flames or sparks in or near the area where refueling is performed or where gasoline is stored.
- Do not overfill the tank. Do not fill the tank neck.
- If gasoline spills on your skin or clothing, immediately wash it off with soap and water and change clothing.
- Never start the engine or let it run in an enclosed area. Engine exhaust fumes are poisonous and can cause loss of consciousness or death in a short time.
- Turn the fuel valve off whenever the vehicle is stored or parked.

### **WARNING**

The engine exhaust from this product contains chemicals known to cause cancer, birth defects or other reproductive harm. Operate this vehicle only outdoors or in well-ventilated areas.

## Break-In Period

The break-in period for your new Polaris ATV is the first ten hours of operation, or the time it takes to use the first two full tanks of gasoline. No single action on your part is as important as following the procedures for a proper break-in. Careful treatment of a new engine and drive components will result in more efficient performance and longer life for these components.

### **CAUTION**

Excessive heat build-up during the first three hours of operation will damage close-fitted engine parts and drive components. Do not operate at full throttle or high speeds during the first three hours of use.

# OPERATION

## Break-In Period

### Engine and Drivetrain Break-in

1. Fill the fuel tank with gasoline. See page 40.
2. Check the oil level on the dipstick. See page 75. Add oil if necessary to maintain the level between the safe and add marks.
3. Drive slowly at first. Select an open area that allows room to familiarize yourself with vehicle operation and handling.
4. Vary the throttle positions. Do not operate at sustained idle.
5. Perform regular checks on fluid levels, controls and areas outlined on the daily pre-ride inspection checklist. See page 49.
6. Pull only light loads.
7. During the break-in period, change both the oil and the filter at 20 hours.

### PVT Break-in (Clutches/Belt)

A proper break-in of the clutches and drive belt will ensure a longer life and better performance. Break in the clutches and belt by operating at slower speeds during the break-in period as recommended. Pull only light loads. Avoid aggressive acceleration and high speed operation during the break-in period.



## Pre-Ride Checklist

**⚠ WARNING**

If a proper inspection is not done before each use, severe injury or death could result. Always inspect the vehicle before each use to ensure it's in proper operating condition.

Item	Remarks	Page
Brake system/lever travel	Ensure proper operation	37 88
Brake fluid	Ensure proper level	86
Auxiliary brake	Ensure proper operation	39
Front suspension	Inspect, lubricate if necessary	73
Rear suspension	Inspect, lubricate if necessary	73
Steering	Ensure free operation	-
Tires	Inspect condition and pressure	91
Wheels/fasteners	Inspect, ensure fastener tightness	91 93
Frame nuts, bolts, fasteners	Inspect, ensure tightness	-
Fuel and oil	Ensure proper levels	40 75
Coolant level (if applicable)	Ensure proper level	84 85
Coolant hoses (if applicable)	Inspect for leaks	-
Throttle	Ensure proper operation	36 120
Indicator lights/switches	Ensure operation	34
Engine stop switch	Ensure proper operation	35
Air filter, pre-filter	Inspect, clean	94
Air box sediment tube	Drain deposits whenever visible	-
Headlamp	Check operation, apply Polaris dielectric grease when lamp is replaced	35 96
Brake light/tail lamp	Check operation, apply Polaris dielectric grease when lamp is replaced	96
Riding gear	Wear approved helmet, goggles, and protective clothing	10

# OPERATION

## Starting the Engine

### ⚠ WARNING

Engine exhaust contains poisonous carbon monoxide and can cause loss of consciousness resulting in severe injury or death. Never run an engine in an enclosed area.

1. Position the vehicle on a level surface.
2. Place the transmission in neutral.
3. Lock the parking brake.

**NOTE:** The starter interlock will prevent the engine from starting if the transmission is in gear and the brake is not engaged.

4. Turn the fuel valve on.
5. Sit on the vehicle.

**NOTE:** Do not use the choke if starting a warm engine. Excessive use of the choke can cause the spark plug to become wet fouled.

6. If the engine is cold, pull the choke knob out until it stops.

**NOTE:** The variable choke is fully on when the knob is pulled completely out. The choke is off when the knob is pushed completely in. The choke can be adjusted gradually, depending on how much choke is needed for starting. Be sure the choke is off during operation, as excess fuel washing into the engine oil will increase wear on engine components.

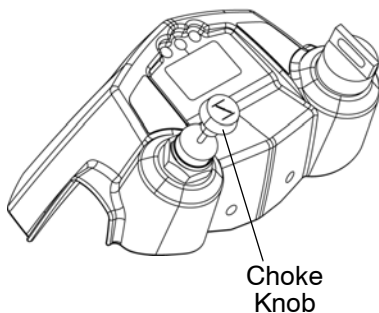

7. Move the engine stop switch to RUN.

**NOTE:** Do not press the throttle while starting the engine.

## Starting the Engine

8. Turn the ignition key past the ON position to engage the starter. Activate the starter for a maximum of five seconds, releasing the key when the engine starts.
9. If the engine does not start, return the key to the OFF position and wait five seconds before attempting to start again. Activate the starter for another five seconds if necessary. Repeat this procedure until the engine starts.

**NOTE:** If a warm engine has cooled to a point where it does not readily start, intermittent use of the choke button (pulled half way out) may be necessary. If the engine is over-choked when warm, depress the throttle lever fully while cranking to aid in starting. Release the throttle lever *immediately* after the engine starts. If the engine does not start and all conditions are favorable, change the spark plug and try again.

10. If the engine slows or stops, position the choke knob half way in to allow proper engine warm up. Vary the engine RPM slightly with the throttle to aid in warm-up. When the engine idles smoothly, push the choke completely in.

### CAUTION

Operating the vehicle immediately after starting could cause engine damage. Allow the engine to warm up for several minutes before operating the vehicle.

## Cold Weather Operation

If the ATV is used year-round, check the oil level frequently. A rising oil level could indicate the accumulation of contaminants such as water or excess fuel in the bottom of the crankcase. Water in the bottom of the crankcase can lead to engine damage and must be drained. Water accumulation increases as outside temperature decreases.

See your Polaris dealer for engine heater kits, which provide quicker warm-ups and easier starting in colder weather.

# OPERATION

## Hauling Cargo

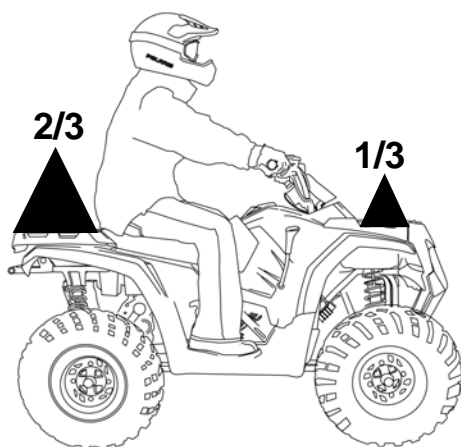

Your ATV has been designed to carry or tow a certain amount of load. Always read and understand the load distribution warning labels on the vehicle, and never exceed the weight capacities outlined in the specifications section of the owner's manual and on the safety decals.

Cargo weight should be evenly distributed ( $1/3$  on the front rack and  $2/3$  on the rear rack) and mounted as low as possible. When operating over rough or hilly terrain, reduce speed and cargo weight to maintain stable driving conditions. Do not obstruct the headlight beam with cargo.

### Towing Loads

Always attach a towed load to the hitch point. If towing a load, reduce rear rack cargo weight by the amount of tongue weight. The combination of rear rack cargo weight and tongue weight must not exceed the rear rack capacity.

### CAUTION

Using an improper hitch or exceeding the maximum tongue weight capacity can result in serious damage to the vehicle and will void your ATV warranty. Never install a hitch longer than  $6\ 3/4"$  (17 cm). Never install automotive accessories on your Polaris ATV. Always install Polaris-approved (or equivalent) accessories designed for ATV use.

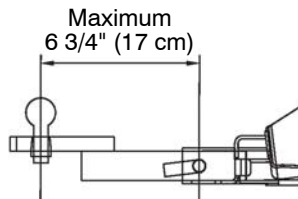

**Hauling Cargo****▲ WARNING**

Hauling cargo improperly can alter vehicle handling and may cause loss of control or brake instability and result in serious injury or death. Always follow these precautions when hauling cargo:

**REDUCE SPEED AND ALLOW GREATER DISTANCES FOR BRAKING WHEN HAULING CARGO.**

**CARGO WEIGHT DISTRIBUTION** should be 1/3 on the front rack and 2/3 on the rear rack. When operating over rough or hilly terrain, reduce speed and cargo to maintain stable driving conditions. Carrying loads on only one rack increases the possibility of vehicle overturn.

**CARRY LOADS AS LOW ON THE RACKS AS POSSIBLE.** Carrying loads high on the racks raises the center of gravity of the vehicle and creates a less stable operating condition.

**SECURE ALL LOADS BEFORE OPERATING.** Unsecured loads can create unstable operating conditions, which could result in loss of control of the vehicle.

**OPERATE ONLY WITH STABLE AND SAFELY ARRANGED LOADS.** When handling off-centered loads that cannot be centered, securely fasten the load and operate with extra caution. Always attach the tow load to the hitch point designated for your vehicle.

**HEAVY LOADS CAN CAUSE BRAKING AND CONTROL PROBLEMS.** Use extreme caution when applying brakes with a loaded vehicle. Avoid terrain or situations that may require backing downhill.

**USE EXTREME CAUTION** when operating with loads that extend over the rack sides. Stability and maneuverability may be adversely affected, causing the vehicle to overturn.

**DO NOT BLOCK THE FRONT HEADLIGHT BEAM** when carrying loads on the front rack.

**DO NOT TRAVEL FASTER THAN THE RECOMMENDED SPEEDS.** Vehicle should never exceed 10 mph (16 kph) while towing a load on a level surface. Vehicle speed should never exceed 5 mph (8 kph) when towing loads in rough terrain, while cornering, or while ascending or descending a hill.

# OPERATION

## Driving Safely

### Driving Procedures



1. Wear protective riding gear. See page 10.
2. Sit upright with both feet on the footrests and both hands on the handlebars.
3. Start the engine and allow it to warm up.
4. Shift the transmission into gear.
5. Check your surroundings and determine your path of travel.
6. Release the parking brake.
7. Slowly depress the throttle with your right thumb and begin driving.
8. Drive slowly. Practice maneuvering and using the throttle and brakes on level surfaces.

## Driving Safely Turning the Vehicle

Your ATV is equipped with a solid rear axle, which drives both rear wheels equally at all times. This means that the wheel on the outside of the turn must travel a greater distance than the inside wheel when turning and the inside tire must slip traction slightly.

To turn, steer in the direction of the turn, leaning your upper body to the inside of the turn while supporting your weight on the outer footrest. This technique alters the balance of traction between the rear wheels, allowing the turn to be made smoothly. The same leaning technique should be used for turning in reverse.



**NOTE:** Practice making turns at slow speeds before attempting to turn at faster speeds.

### **▲ WARNING**

Turning at sharp angles or at excessive speeds can result in vehicle overturn and lead to serious injury. Avoid turning at sharp angles. Never turn at high speeds.

# OPERATION

## Driving Safely

### Driving on Slippery Surfaces

Whenever riding on slippery surfaces such as wet trails or loose gravel, or during freezing weather, follow these precautions:

1. Slow down when entering slippery areas.
2. Engage AWD before wheels begin to lose traction.
3. Maintain a high level of alertness, reading the trail and avoiding quick, sharp turns, which can cause skids.
4. Correct a skid by turning the handlebars in the direction of the skid and shifting your body weight forward.



### CAUTION

Severe damage to drive train may occur if the AWD is engaged while the wheels are spinning. Always allow the rear wheels to stop spinning before engaging AWD, or engage AWD before wheels begin to lose traction.

### ⚠ WARNING

Failure to exercise care when operating on slippery surfaces can result in loss of tire traction and cause loss of control, accident, and serious injury or death.

Never apply the brakes during a skid. Do not operate on excessively slippery surfaces. Always reduce speed and use additional caution.



## Driving Safely Driving Uphill

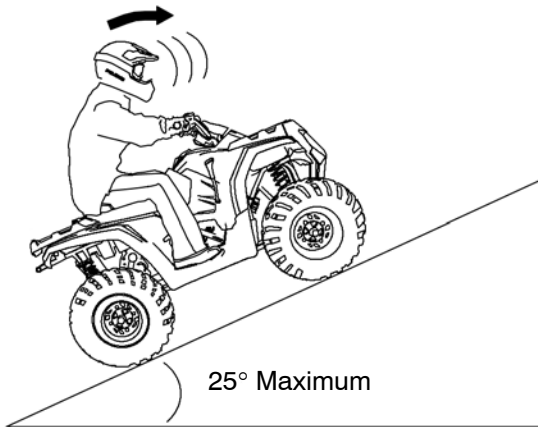

Whenever traveling uphill, follow these precautions:

1. Drive straight uphill.
2. Avoid steep hills (25° maximum).
3. Keep both feet on the footrests.
4. Shift your weight uphill.
5. Proceed at a steady rate of speed and throttle opening.
6. Remain alert and be prepared to take emergency action. This may include quick dismounting of the vehicle.

### **⚠ WARNING**

Braking and handling are greatly affected when operating in hilly terrain. Improper procedure could cause loss of control or overturn and result in serious injury or death.

Avoid climbing steep hills (25° maximum).

Use extreme caution when operating on hills, and follow proper operating procedures outlined in the owner's manual.

# OPERATION

## Driving Safely

### Driving on a Sidehill (Sidehilling)



#### **⚠ WARNING**

Improperly crossing hills or turning on hills can result in loss of control or vehicle overturn, resulting in severe injury or death. Avoid crossing the side of a hill when possible. Follow proper procedures as outlined in the owner's manual.

Sidehilling can be dangerous and should be avoided if at all possible. If you encounter a situation where sidehilling is necessary, follow these precautions:

1. Slow down.
2. Shift your weight uphill.
3. Keep your feet on the footrests.
4. Steer slightly into the hill to maintain vehicle direction.

**NOTE:** If the vehicle begins to tip, quickly turn the front wheel downhill, if possible, or dismount on the uphill side *immediately!*

## Driving Safely Driving Downhill



### **▲ WARNING**

Excessive speed when traveling downhill can cause loss of control and serious injury or death. Slow down.

Applying the brakes too firmly may cause the rear wheels to lock, which could result in loss of control and serious injury or death. Apply the brakes gradually.

When driving downhill, follow these precautions:

1. Shift your weight uphill.
2. Drive straight downhill.
3. Slow down.
4. Squeeze the brake lever gradually.

**NOTE:** Before operating your ATV, learn how to use the auxiliary brake for emergency situations (if single-lever brakes become inoperable).

# OPERATION

## Driving Safely

### Turning Around on a Hill (K-Turn)

If the vehicle stalls while climbing a hill, never back it down the hill!  
Use the K-turn to turn around.

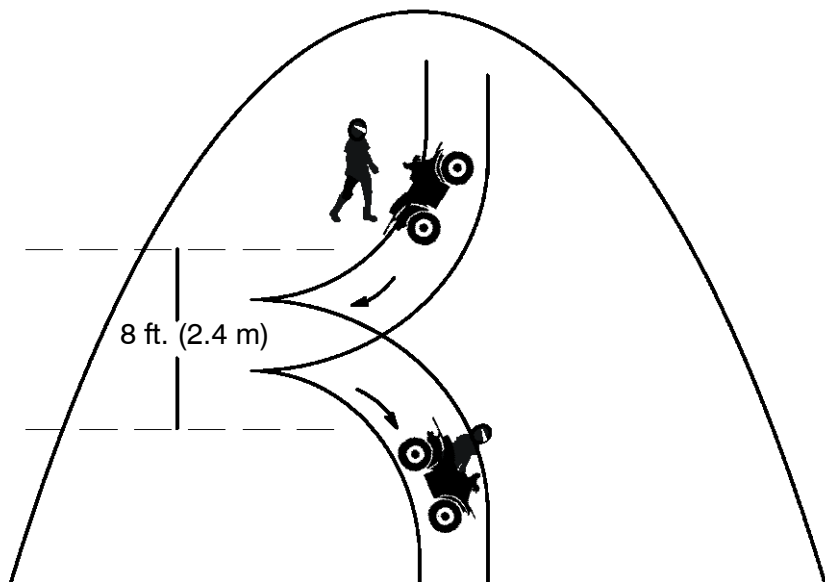

## Driving Safely

### Turning Around on a Hill (K-Turn)

1. Stop and lock the parking brake while keeping body weight uphill.
2. Leave the transmission in forward and shut off the engine.
3. Dismount on the uphill side of the vehicle, or on the left if the vehicle is pointing straight uphill.
4. Staying uphill of the vehicle, turn the handlebars full left.
5. While holding the brake lever, release the parking brake lock and slowly allow the vehicle to roll around to your right until it's pointing across the hill or slightly downward.
6. Lock the parking brake. Remount the vehicle from the uphill side, keeping body weight uphill.
7. Start the engine with the transmission still in forward.
8. Release the parking brake and proceed *slowly*, controlling speed with the brake lever, until the vehicle is on more level ground.

# OPERATION

## Driving Safely

### Driving Through Water



Maximum Depth

Your ATV can operate through water with a maximum recommended depth equal to the bottom of the footrests. Follow these procedures when operating through water:

1. Determine water depths and current before crossing.
2. Choose a crossing where both banks have gradual inclines.
3. Proceed slowly, avoiding rocks and obstacles.
4. After crossing, dry the brakes by applying light pressure to the lever until braking action is normal.

## Driving Safely

### Driving Through Water

After running the vehicle in water, it's critical to have it serviced as outlined in the maintenance chart. See page 68. The following areas need special attention: engine oil, transmission oil, front and rear gearcases, and all grease fittings.

#### CAUTION

Major engine damage can result if the vehicle is not thoroughly inspected after operation in water. Perform the services outlined in the maintenance chart.

If your vehicle becomes immersed or is operated in water that exceeds the footrest level, take it to your dealer for service before starting the engine.

**NOTE:** Avoid operating the vehicle through deep or fast-flowing water. If you cannot avoid water that exceeds the recommended maximum depth, go slowly, balance your weight carefully, avoid sudden movements, and maintain a slow and steady forward motion. Do not make sudden turns or stops, and do not make sudden throttle changes.

If your vehicle becomes immersed, and it's impossible to take it to a dealer before starting it, follow the steps described on page 100. Have the vehicle serviced by your dealer at the first opportunity.

# OPERATION

## Driving Safely

### Driving Over Obstacles

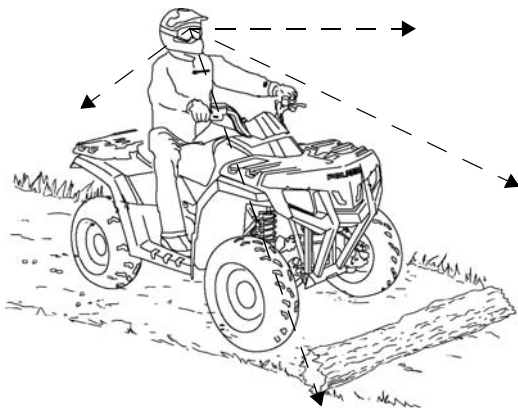

Be alert! Look ahead and learn to read the terrain you're traveling on. Be constantly alert for hazards such as logs, rocks and low hanging branches.

#### **⚠ WARNING**

Severe injury or death can result if your vehicle comes in contact with a hidden obstacle. Not all obstacles are immediately visible. Travel with caution in unfamiliar terrain.



## Driving Safely

### Driving in Reverse

Follow these precautions when operating in reverse:

1. Always check for obstacles or people behind the vehicle.
2. Always avoid backing downhill.
3. Back slowly.
4. Apply the brakes *lightly* for stopping.
5. Avoid turning at sharp angles.
6. Never open the throttle suddenly.

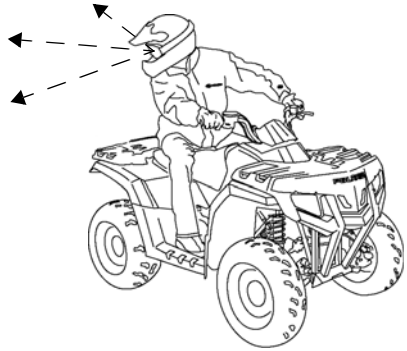

### **⚠ WARNING**

Failure to use caution when operating in reverse can result in serious injury or death. Before shifting into reverse, always check for obstacles or people behind the vehicle. When it's safe to proceed, back slowly.

Do not use the override switch unless additional power is required for vehicle movement. Use with caution.

Avoid backing on inclines, and avoid turning at sharp angles.

**NOTE:** Your Polaris ATV is equipped with a reverse speed limiter. Use the override button with caution as rearward vehicle speed is greatly increased. Do not operate at wide open throttle.

### **CAUTION**

Excessive throttle operation while in the speed limit mode may cause fuel to build in the exhaust, resulting in engine popping and/or engine damage. Operate the throttle just enough to maintain a desired speed.

# OPERATION

## Driving Safely

### Parking on an Incline

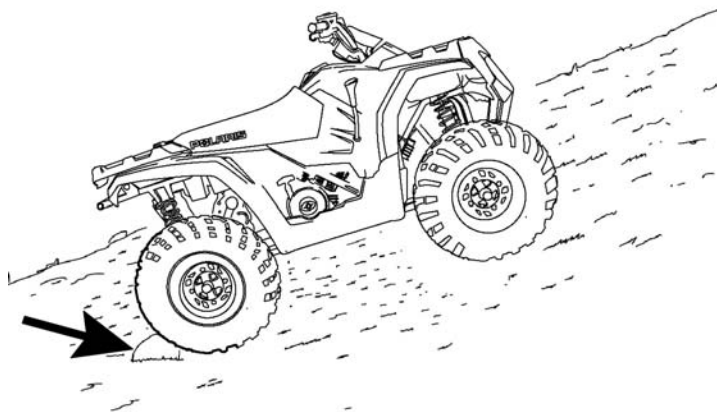

Avoid parking on an incline if possible. If it's unavoidable, follow these precautions:

1. Stop the engine.
2. Place the transmission in gear.
3. Lock the parking brake.
4. Always block the rear wheels on the downhill side.
5. Turn the fuel valve off.

# EMISSION CONTROL SYSTEMS

## Noise Emission Control System

Do not modify the engine, intake or exhaust components, as doing so may affect compliance with U.S.A. EPA noise control requirements (40 CFR 205) and local noise level requirements.

## Operation on Public Lands in the U.S.A.

Your Polaris vehicle has a spark arrestor that was tested and qualified to be in accordance with the USDA Forest Service Standard 5100-1C. Federal law requires that this spark arrestor be installed and functional when the vehicle is operated on public lands.

Operation of off-road vehicles on public lands in the U.S.A. is regulated by 43 CFR 8343.1(c). Violations are subject to monetary penalties. Federal regulations can be viewed online at [www.gpoaccess.gov/ecfr/](http://www.gpoaccess.gov/ecfr/).

## Crankcase Emission Control System

This engine is equipped with a closed crankcase system. Blow-by gases are forced back to the combustion chamber by the intake system. All exhaust gases exit through the exhaust system.

## Exhaust Emission Control System

The emissions from the exhaust of this vehicle are controlled by engine design, including factory-set fuel delivery and ignition. The engine and related components must be maintained at Polaris specifications to achieve optimal performance.

Engine idle speed is the only adjustment Polaris recommends that the operator perform. Any other adjustments should be performed by an authorized Polaris dealer.

The compliance label is located on right front portion of the frame or on the rear independent rear suspension (IRS) tube.

## Electromagnetic Interference

This spark ignition system complies with Canadian ICES-002.

This vehicle complies with the EMC requirements of European directives 97/24/EC and 89/336/EEC.

# MAINTENANCE

## Periodic Maintenance Chart

Careful periodic maintenance will help keep your vehicle in the safest, most reliable condition. Inspection, adjustment and lubrication of important components are explained in the periodic maintenance chart.

Inspect, clean, lubricate, adjust and replace parts as necessary. When inspection reveals the need for replacement parts, use genuine Polaris parts available from your Polaris dealer.

Record maintenance and service in the Maintenance Log beginning on page 134.

**NOTE:** Service and adjustments are important for proper vehicle operation. If you're not familiar with safe service and adjustment procedures, have a qualified dealer perform these operations.

Maintenance intervals in the following chart are based upon average riding conditions and an average vehicle speed of approximately 10 miles per hour (16 km/h). Vehicles subjected to severe use must be inspected and serviced more frequently.

### Severe Use Definition

- Frequent immersion in mud, water or sand
- Racing or race-style high RPM use
- Prolonged low speed, heavy load operation
- Extended idle
- Short trip cold weather operation

Pay special attention to the oil level. A rise in oil level during cold weather can indicate contaminants collecting in the oil sump or crankcase. Change oil immediately if the oil level begins to rise. Monitor the oil level, and if it continues to rise, discontinue use and determine the cause or see your dealer.

## Periodic Maintenance Chart

### Maintenance Chart Key

▶ Perform these operations more often for vehicles subjected to severe use.

E Emission-related service (Failure to conduct this maintenance will not void the emissions warranty but may affect emissions.)

■ Have an authorized Polaris dealer perform these services.

<b>⚠ WARNING</b>
------------------

Improperly performing the procedures marked with a ■ could result in component failure and lead to serious injury or death. Have an authorized Polaris dealer perform these services.
---

# MAINTENANCE

## Periodic Maintenance Chart

Perform all services at whichever maintenance interval is reached first.

	Item	Maintenance Interval (whichever comes first)			Remarks
		Hours	Calendar	Miles (Km)	
■	Steering	-	Pre-Ride	-	Make adjustments as needed. See Pre-Ride Checklist on page 49.
▶	Front suspension	-	Pre-Ride	-	
▶	Rear suspension	-	Pre-Ride	-	
	Tires	-	Pre-Ride	-	
▶	Brake fluid level	-	Pre-Ride	-	
▶	Brake lever travel	-	Pre-Ride	-	
	Brake system	-	Pre-Ride	-	
	Wheels/fasteners	-	Pre-Ride	-	
	Frame fasteners	-	Pre-Ride	-	
▶	Engine oil level	-	Pre-Ride	-	
▶ E	Air filter, pre-filter	-	Daily	-	Inspect; clean often; replace as needed
▶	Air box sediment tube	-	Daily	-	Drain deposits when visible
	Coolant (if applicable)	-	Daily	-	Check level daily, change coolant every 2 years
	Headlamp/tail lamp	-	Daily	-	Check operation; apply dielectric grease if replacing
▶ E	Air filter, main element	-	Weekly	-	Inspect; replace as needed
	Recoil housing (if applicable)	-	Weekly	-	Drain water as needed, check often if operating in wet conditions
▶ ■	Brake pad wear	10 H	Monthly	100 (160)	Inspect periodically
	Battery	20 H	Monthly	200 (320)	Check terminals; clean; test
▶	Front gearcase oil (if equipped)	25 H	Monthly	250 (400)	Inspect level; change yearly
▶	Transmission oil	25 H	Monthly	250 (400)	Inspect level; change yearly
▶ E	Engine breather filter (if equipped)	25 H	Monthly	250 (400)	Inspect; clean if needed

▶ Perform these procedures more often for vehicles subjected to severe use.

E Emission-Related Service

■ Have an authorized Polaris dealer perform these services.

## Periodic Maintenance Chart

Item		Maintenance Interval (whichever comes first)			Remarks
		Hours	Calendar	Miles (Km)	
▶	General lubrication	50 H	3 M	500 (800)	Lubricate all fittings, pivots, cables, etc.
	Carburetor float bowl	50 H	6 M	500 (800)	Drain bowl periodically and prior to storage
■ E	Throttle Cable/ ETC Switch	50 H	6 M	500 (800)	Inspect; adjust; lubricate; replace if necessary
■ E	Choke cable	50 H	6 M	500 (800)	Inspect; adjust; lubricate; replace if necessary
E	Carburetor air intake ducts/flange	50 H	6 M	500 (800)	Inspect duct for proper sealing/air leaks
	Drive belt	50 H	6 M	500 (800)	Inspect; adjust; replace as needed
	Cooling system (if applicable)	50 H	6 M	1000 (1600)	Inspect coolant strength seasonally; pressure test system yearly
▶	Engine oil change	100 H	6 M	1000 (1600)	Perform a break-in oil change at 20 hours
▶	Oil filter change	100 H	6 M	1000 (1600)	Replace with oil change
▶	Oil tank vent hose (if equipped)	100 H	6 M	1000 (1600)	Inspect routing, condition
■ E	Valve clearance	100 H	12 M	1000 (1600)	Inspect; adjust
■ E	Fuel system/filter	100 H	12 M	1000 (1600)	Check for leaks at tank cap, lines, fuel valve, filter, pump, carburetor; replace lines every two years
▶	Radiator (if applicable)	100 H	12 M	1000 (1600)	Inspect; clean external surfaces
▶	Cooling hoses (if applicable)	100 H	12 M	1000 (1600)	Inspect for leaks
▶	Engine mounts	100 H	12 M	1000 (1600)	Inspect
	Exhaust muffler/pipe	100 H	12 M	1000 (1600)	Inspect
■ E	Spark plug	100 H	12 M	1000 (1600)	Inspect; replace as needed
■ E	Ignition Timing	100 H	12 M	1000 (1600)	Inspect
▶	Wiring	100 H	12 M	1000 (1600)	Inspect for wear, routing, security; apply dielectric grease to connectors subjected to water, mud, etc.

# MAINTENANCE

## Periodic Maintenance Chart

Item		Maintenance Interval (whichever comes first)			Remarks
		Hours	Calendar	Miles (Km)	
■	Clutches (drive and driven)	100 H	12 M	1000 (1600)	Inspect; clean; replace worn parts
■	Front wheel bearings	100 H	12 M	1000 (1600)	Inspect; replace as needed
■	Brake fluid	200 H	24 M	2000 (3200)	Change every two years
	Spark arrestor	300 H	36 M	3000 (4800)	Clean out
	Idle speed	-			Adjust as needed
■	Toe adjustment	-			Inspect periodically; adjust when parts are replaced
	Headlight aim	-			Adjust as needed

► Perform these procedures more often for vehicles subjected to severe use.

E Emission-Related Service

■ Have an authorized Polaris dealer perform these services.



## Lubrication Guide

Check and lubricate all components at the intervals outlined in the Periodic Maintenance Chart beginning on page 68. Items not listed in the chart should be lubricated at the General Lubrication interval.

Item	Lube	Method
Engine Oil	PS-4 PLUS Performance Synthetic 2W-50	See page 74.
Brake Fluid	DOT 4 Only	See page 86.
Transmission Oil	Polaris AGL Synthetic Gearcase Lube	See page 78.
Front Demand Drive Unit (Front Gearcase)	Premium Demand Drive Hub Fluid	See page 81.
Front Prop Shaft Yoke	Polaris Premium U-Joint Lube	Grease fittings (3 pumps maximum) every 500 miles (800 km), before long periods of storage, or after pressure washing or submerging.
Control Arm (front and rear)		
Bearing Carrier		
Transmission (upper pivot point)		

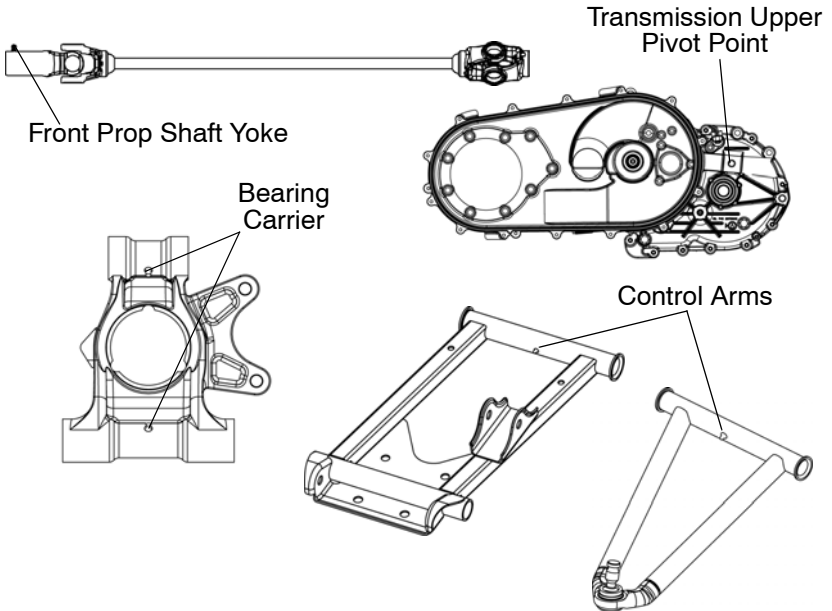

# MAINTENANCE

## Engine Oil

### Oil Recommendations

Polaris recommends the use of Polaris PS-4 *PLUS Performance* Synthetic 2W-50 4-cycle oil or a similar oil for this engine. Oil may need to be changed more frequently if Polaris oil is not used. Always use 2W-50 oil. Follow the manufacturer's recommendations for ambient temperature operation.

### CAUTION

Mixing brands or using a non-recommended oil may cause serious engine damage. Always use the recommended oil. Never substitute or mix oil brands.

### Oil Specifications

Lubricant	Capacity	Drain Plug Torque
PS-4 PLUS Performance Synthetic 2W-50 4-Cycle Oil	2 qts. (1.9 l)	14 ft. lbs. (19 Nm)

## Engine Oil Oil Level

The oil dipstick is located behind the left front tire.

1. Position the vehicle on a level surface.
2. Place the transmission in neutral.
3. Lock the parking brake.
4. Clean away all dirt and debris on the oil tank or in the wheel well area.

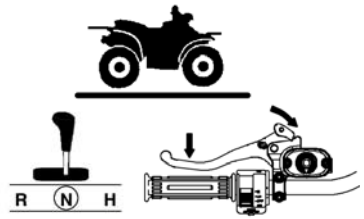

- 
5. Start the engine. Allow it to idle for 30 seconds. Stop the engine.
  6. Remove the dipstick. Wipe it dry with a clean cloth.
  7. Reinstall the dipstick completely.

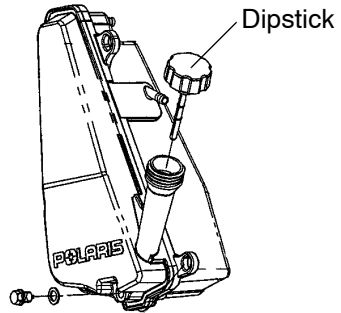

- 
8. Remove the dipstick and check the oil level. Add oil as needed. Maintain the oil level in the safe range. Do not overfill.

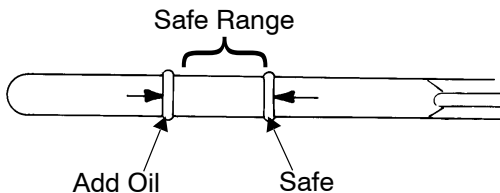

- 
9. Reinstall the dipstick.
-

# MAINTENANCE

## Oil and Filter Change

### ⚠ CAUTION

Hot oil can cause serious burns to skin. Do not allow hot oil to contact skin.

Always change the oil and filter at the intervals outlined in the Periodic Maintenance Chart beginning on page 68. To change the oil properly, always drain the oil tank and change the oil filter.

**NOTE:** If oil contamination (water, mud, metal shavings) is suspected in the engine sump, the sump should also be drained. Draining the engine sump will require additional oil not contained in the oil change kit. The total oil capacity of the engine sump *and* oil tank combined is 2.25 qts. (2.1 liters).

1. Position the vehicle on a level surface.
2. Place the transmission in neutral.
3. Lock the parking brake.

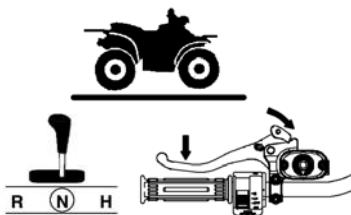

4. Start the engine. Allow it to idle for two to three minutes. Stop the engine.
5. Clean the area around the oil tank drain plug.
6. Place a drain pan under the oil tank.
7. Remove the drain plug. Use a 14 mm wrench.
8. Drain the oil.

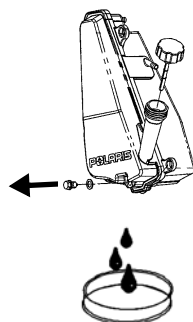

9. Reinstall the oil tank drain plug.

**NOTE:** The sealing surfaces on the drain plug and oil tank should be clean and free of burrs, nicks or scratches.

10. Torque to specification. See page 74.

## Oil and Filter Change

11. Place towels under the oil filter. Using an oil filter wrench, turn the filter counterclockwise to remove it.
12. Clean the filter sealing area on the engine.
13. Lubricate the filter o-ring. Check to make sure the o-ring is in good condition.
14. Install the new oil filter. After the filter contacts the engine surface, turn it 1/2 turn by hand.

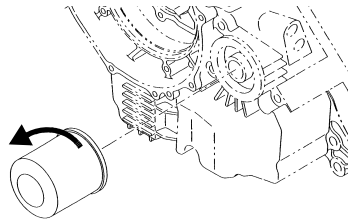

- 
15. Remove the dipstick.
  16. Add the recommended oil. See page 74.
  17. Reinstall the dipstick.
  18. Start the engine. Allow it to idle for two minutes.
  19. Stop the engine.
  20. Check for oil leaks.
  21. Remove the dipstick and check the oil level. Add oil as needed. Maintain the oil level in the safe range. Do not overfill.

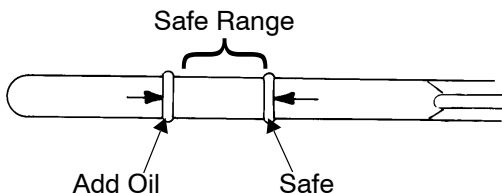

22. Reinstall the dipstick.
- 
23. Discard used oil and filter properly.

# MAINTENANCE

## Transmission Oil

Always check and change the transmission oil at the intervals outlined in the Periodic Maintenance Chart beginning on page 68. Maintain the oil level at the bottom of the fill plug hole. See page 121 for the part numbers of Polaris products.

The fill plug is located on the left side of the ATV, under the rear fender, behind the wheel. The drain plug is located behind the wheel well.

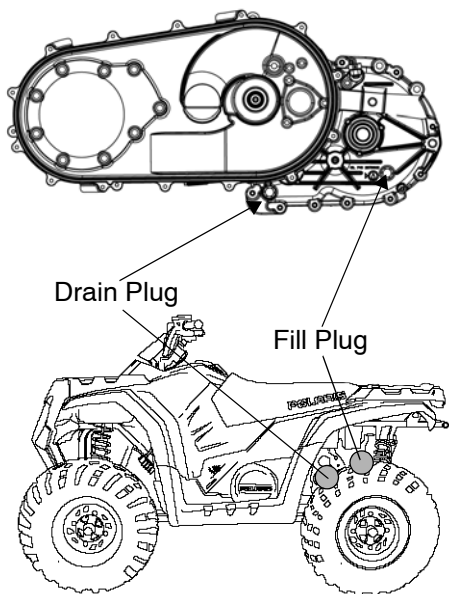

## Transmission Oil Recommendations

Gearcase	Lubricant	Capacity	Fill Plug Torque	Drain Plug Torque
Transmission	Premium AGL Synthetic Gearcase Lubricant	20.3 oz. (600 ml)	15 ft. lbs. (20 Nm)	15 ft. lbs. (20 Nm)

## Transmission Oil Oil Check

1. Position the vehicle on a level surface.
2. Place the transmission in gear.
3. Lock the parking brake.

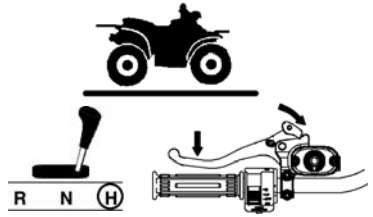

4. Remove the fill plug.  
Use a 15 mm wrench.
5. Check the oil level.
6. Add oil as needed. Do not overfill.
7. Reinstall the fill plug.  
Torque to specification.  
See page 78 for recommendations.

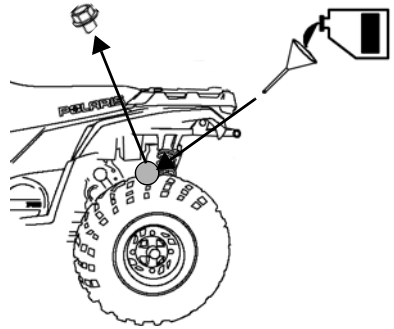

# MAINTENANCE

## Transmission Oil

### Oil Change

1. Position the vehicle on a level surface.
2. Place the transmission in gear.
3. Lock the parking brake.

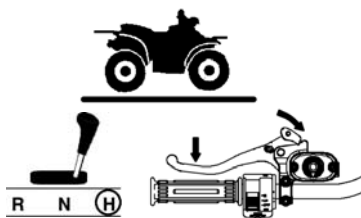

4. Remove the fill plug.  
Use a 15 mm wrench.
5. Place a drain pan under the gearcase.
6. Remove the drain plug.  
Use a 15 mm wrench.
7. Allow the oil to drain completely.

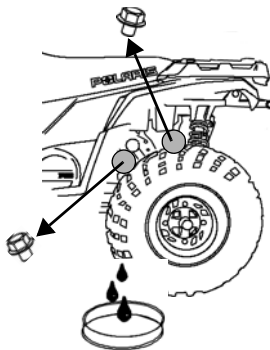

8. Clean and reinstall the drain plug. Torque to specification. See page 78 for recommendations.
9. Add the recommended oil.
10. Reinstall the fill plug. Torque to specification. See page 78 for recommendations.
11. Check for leaks.
12. Dispose of used oil properly.

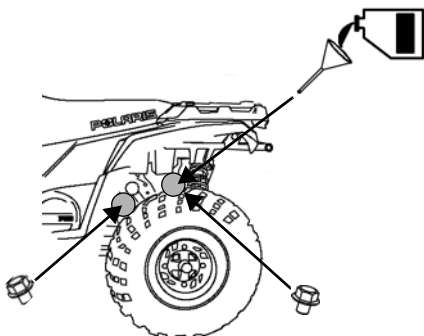



# MAINTENANCE

## Front Gearcase (Demand Drive) Fluid

Always check and change the demand drive fluid at the intervals outlined in the Periodic Maintenance Chart beginning on page 68. We recommend the use of Polaris Premium Demand Drive Hub Fluid. Use of other oils may result in improper operation of components. See page 121 for the part numbers of Polaris products.

Maintain the fluid level at the bottom of the fill hole threads. The fill plug is located on the right side of the gearcase. The drain plug is located on the bottom right side of the gearcase.

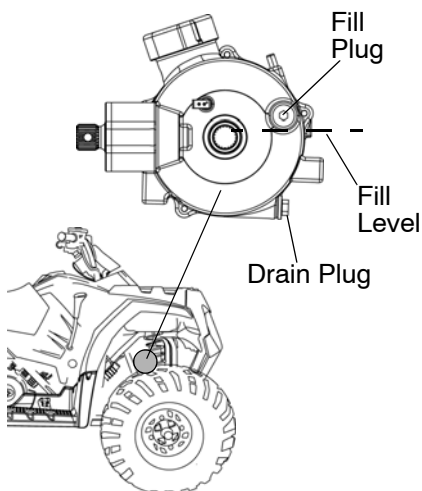

## Demand Drive Fluid Recommendations

Gearcase	Lubricant	Capacity	Fill Plug Torque	Drain Plug Torque
Demand Drive Unit	Premium Demand Drive Hub Fluid	5 oz. (148 ml)	8-10 ft. lbs. (11-13 Nm)	8-10 ft. lbs. (11-13 Nm)

# MAINTENANCE

## Front Gearcase (Demand Drive) Fluid Fluid Check

1. Position the vehicle on a level surface.
2. Place the transmission in gear.
3. Lock the parking brake.

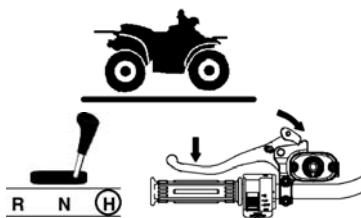

- 
4. Remove the fill plug. Use an 8 mm Allen wrench.
  5. Check the oil level.
  6. Add the recommended oil as needed to bring the level to the bottom of the fill hole threads.
  7. Reinstall the fill plug. Torque to specification. See page 81.

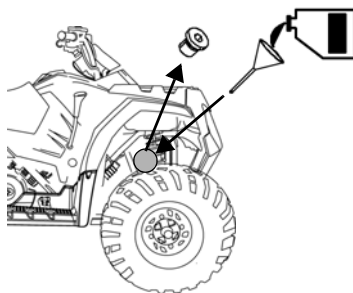

# MAINTENANCE

## Front Gearcase (Demand Drive) Fluid Fluid Change

1. Position the vehicle on a level surface.
2. Place the transmission in gear.
3. Lock the parking brake.

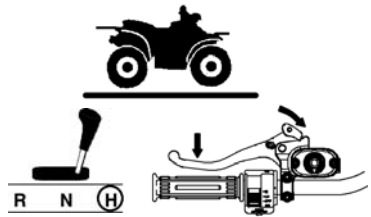

- 
4. Remove the fill plug. Use an 8 mm Allen wrench.
  5. Place a drain pan under the gearcase.
  6. Remove the drain plug. Use an 8mm Allen wrench.
  7. Allow the oil to drain completely.

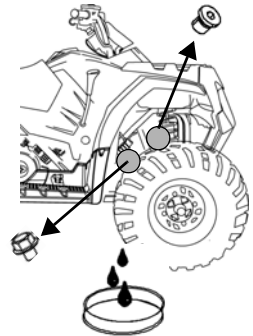

- 
8. Clean and reinstall the drain plug. Torque to specification. See page 81.
  9. Add the recommended fluid.
  10. Reinstall the fill plug. Torque to specification.
  11. Check for leaks.
  12. Dispose of used oil properly.

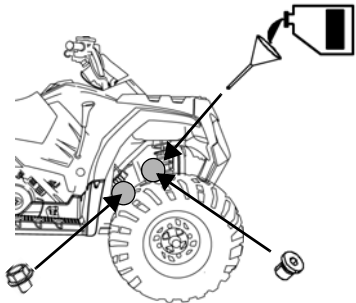

# MAINTENANCE

## Cooling System

The engine coolant level is controlled, or maintained, by the recovery system. The recovery system components are the recovery bottle, the radiator filler neck, the radiator pressure cap and the connecting hose.

As coolant operating temperature increases, the expanding (heated) excess coolant is forced out of the engine, past the pressure cap, and into the recovery bottle. As engine coolant temperature decreases the contracting (cooled) coolant is drawn back up from the bottle, past the pressure cap, and into the radiator.

**NOTE:** Some coolant level drop on new vehicles is normal as the system is purging itself of trapped air. Check the coolant level and maintain as recommended by adding coolant to the recovery bottle.

Polaris recommends the use of Polaris Premium 60/40 anti-freeze/coolant or a 50/50 mixture of high quality aluminum compatible anti-freeze/coolant and distilled water. Polaris Premium 60/40 is already premixed and ready to use. Do not dilute with water. See page 121 for the part numbers of Polaris products.

**NOTE:** Always follow the manufacturer's mixing recommendations for the freeze protection required in your area.

## Recovery Bottle Coolant

The recovery bottle is located under the front storage box cover near the radiator cap. Maintain the coolant level between the minimum and maximum marks on the bottle (when the fluid is cool).

1. Position the vehicle on a level surface.
2. Open the front storage box cover.
3. View the coolant level.
4. Add coolant as needed.



## Cooling System Radiator Coolant

To ensure that the coolant maintains its ability to protect the engine, Polaris recommends that you drain the system completely every two years and add a fresh mixture of antifreeze and water.

Replace the coolant any time the cooling system has been drained for maintenance or repair. If the recovery bottle has run dry, check the level in the radiator. Add coolant as needed.

### **⚠ WARNING**

Escaping steam can cause severe burns. Never remove the pressure cap while the engine is warm or hot. Always allow the engine to cool before removing the pressure cap.

1. Open the front storage box cover.
2. Remove the pressure cap.
3. Using a funnel, slowly add coolant through the radiator filler neck.
4. Reinstall the pressure cap.
5. Secure the box cover.

**NOTE:** Use of a non-standard pressure cap will not allow the recovery system to function properly. Contact your dealer for the correct replacement part.



# MAINTENANCE

## Brake Fluid

Check brake fluid levels for both brake systems before each ride. Always maintain brake fluid at the recommended level. Do not overfill.

### **WARNING**

An over-full master cylinder may cause brake drag or brake lock-up, which could result in serious injury or death. Maintain brake fluid at the recommended level. Do not overfill.

If the fluid level is low add DOT 4 brake fluid only. See page 121 for the part numbers of Polaris products.

### **WARNING**

Never store or use a partial bottle of brake fluid. Brake fluid is hygroscopic, meaning it rapidly absorbs moisture from the air. The moisture causes the boiling temperature of the brake fluid to drop, which can lead to early brake fade and the possibility of accident or severe injury. After opening a bottle of brake fluid, always discard any unused portion.

Under normal operation, the diaphragm extends into the reservoir as fluid level drops. If the fluid level is low and the diaphragm is not extended, a leak is likely and the diaphragm should be replaced. To ensure proper diaphragm operation, always fill the reservoir as needed whenever the cover is loosened or removed. Do not overfill.

## Brake Fluid

### Hand Brake

The master cylinder is located on the left handlebar. Maintain the fluid level  $1/4"$  (6.3 mm) below the top edge of the master cylinder. Do not overfill.

1. Position the vehicle on a level surface. Make sure the handlebars are straight.
2. View the fluid level through the indicator window (eye) on the top of the master cylinder.

**NOTE:** The eye will appear dark when the fluid level is full. When fluid is low, the eye will be clear.

3. Add the recommended fluid as needed. Do not overfill.

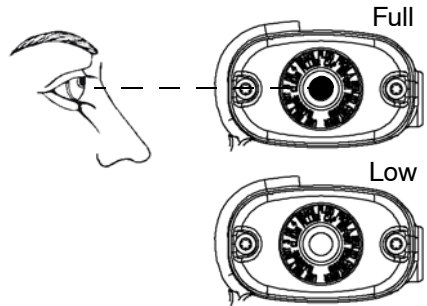
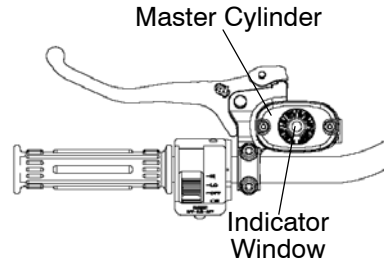

### Foot Brake

The brake fluid reservoir is located in the front storage box. Maintain the fluid level between the minimum and maximum marks. Do not overfill.

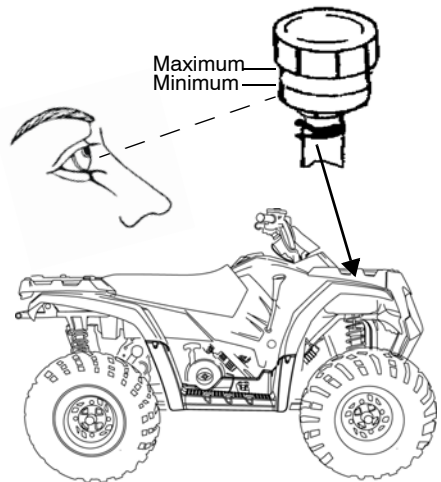

# MAINTENANCE

## Brakes

The front and rear brakes are hydraulic disc brakes, activated by moving the single brake lever toward the handlebar. The auxiliary foot brake is also hydraulic. Both brake systems are self-adjusting.

### Brake Inspections

The following checks are recommended to keep the brake system in good operating condition. Check more often if brakes are used heavily under normal operation.

1. Always keep brake fluid at an adequate level. See page 86.
2. Check the brake system for fluid leaks.
3. Check the brakes for excessive travel or spongy feel.
4. Check the friction pads for wear, damage and looseness. Replace the pads when the friction material is worn to .03" (.8 mm).
5. Check the security and surface condition of the disc.

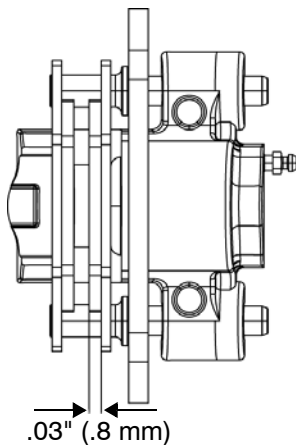



## Toe Alignment

### ⚠ WARNING

Severe injury or death can result from improper toe alignment and adjustment. Do not attempt to adjust tie rod alignment. All tie rod adjustments should be performed by an authorized Polaris dealer.

Use the following procedure to check the toe alignment of the vehicle. The recommended toe alignment is 1/8" to 1/4" (3-6 mm) toe out.

1. Position the vehicle on a level surface.
2. Place the handlebars in a straight-ahead position.
3. Tie a length of string between two stands as shown in the illustration. Position the stands so that the string is flush with the side of the rear tire.

**NOTE:** If available, you may use a long straight-edge instead of string.

4. Measure the distance from the string to the rim at the front (1) and rear (2) of the front rim.

The rear measurement should be 1/16"-1/8" (2-3 mm) more than the front measurement on each side of the vehicle to obtain the recommended 1/8" to 1/4" (3-6 mm) toe out alignment.

5. Repeat the measurement procedure on the other side of the vehicle.

**NOTE:** If you discover improper alignment, see your Polaris dealer for service.

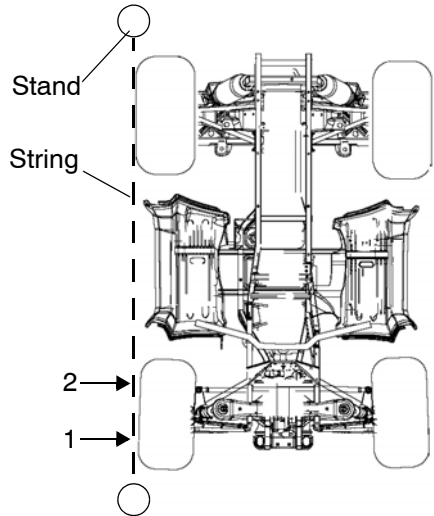

# MAINTENANCE

## Steering Assembly

The steering assembly of the ATV should be checked periodically for loose nuts and bolts. If loose nuts and bolts are found, see your Polaris dealer for service before operating the vehicle.

## Side Panel Removal

1. Remove the seat.
2. Grasp the top of the side panel and pull it outward to remove it.

## Footwell Removal

1. Remove the two screws on the bottom of the footwell.
2. Use a flat screwdriver or sidecutters to remove the plastic rivets securing the footwell to the fenders.
3. Remove the footwell.

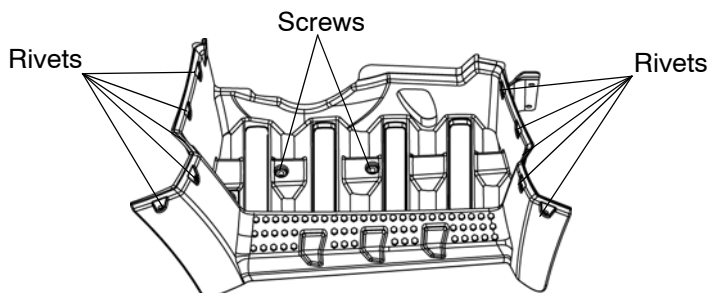

## Tires

Refer to the specifications section beginning on page 126 for recommended tire type, size and pressure.

### **⚠ WARNING**

Operating your ATV with worn tires, improperly inflated tires, non-standard tires or improperly installed tires will affect vehicle handling and could cause an accident resulting in serious injury or death.

Maintain proper tire pressure as described on the decal on your ATV and in the owner's manual.

Always use original equipment size and type when replacing tires.

Make sure the wheels are installed properly.

Always replace tires when the tread depth measures 1/8" (3 mm) or less.

### Tire Tread Depth

Always replace tires when tread depth is worn to 1/8" (3 mm) or less.

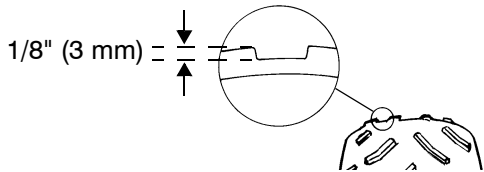

### Front Wheel Hub Tightening

Front wheel bearing tightness and spindle nut retention are critical component operations. All service must be performed by your authorized Polaris dealer.

# MAINTENANCE

## Tires

### Wheel Removal

1. Position the vehicle on a level surface.
2. Place the transmission in gear.
3. Lock the parking brake.

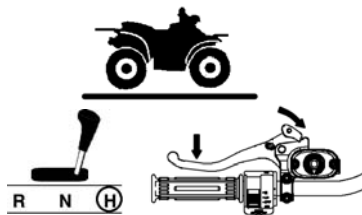

- 
4. Loosen the wheel nuts slightly.
  5. Place a suitable stand under the footrest frame to raise the wheel slightly off the ground.



- 
6. Remove the wheel nuts.
  7. Remove the wheel.

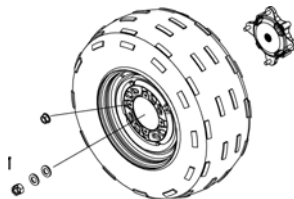

## Tires

### Wheel Installation

#### **⚠ WARNING**

Improperly installed wheels can adversely affect tire wear and vehicle handling, which can result in serious injury or death. Always ensure that all nuts are torqued to specification. Do not service axle nuts that have a cotter pin installed. See your Polaris dealer.

1. Place the wheel on the wheel hub with the valve stem toward the outside and the rotation arrows on the tire pointing toward forward rotation.
2. Install the wheel nuts finger tight.

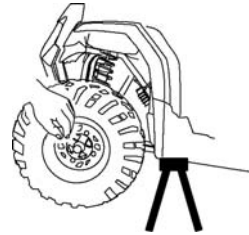

3. Lower the vehicle to the ground.
4. Torque the wheel nuts to specification.



### Wheel Nut Torque Specifications



CAST ALUMINUM

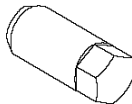

90 ft. lbs.  
(122 Nm)



STEEL



27 ft. lbs.  
(37 Nm)

Check the wheel nut torques occasionally and when they've been loosened for service.

Nut Type	Nut Torque
Lug Nut	90 ft. lbs. (122 Nm)
2-Piece Flange Nut	27 ft. lbs. (37 Nm)

# MAINTENANCE

## Air Filter

1. Position the vehicle on a level surface. Place the transmission in gear.
2. Lock the parking brake.
3. Remove the seat.

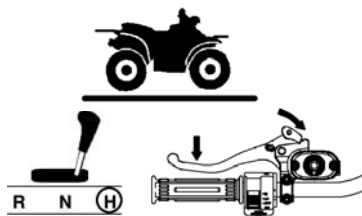

4. Release the air box cover clips, and remove the air box cover.
5. Loosen the clamp and remove the filter.
6. Remove the fabric type pre-filter from the main filter. Wash the pre-filter in soapy water, then rinse and let dry.
7. Reinstall the pre-filter over the main filter.

**NOTE:** Install a new main filter if needed.

8. Reinstall the filter into the air box and tighten the clamp. Do not over-tighten the clamp, as filter damage could occur.
9. Reinstall the air box cover and the seat.

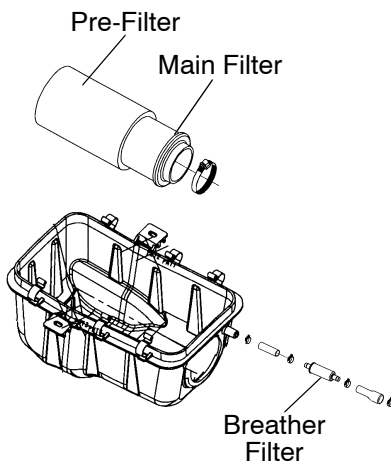

## Breather Filter/Hose

1. Remove the left side panel. See page 90.
2. Remove the hose clamps from the filter and pull the filter out of the hoses. Inspect the filter for debris. Blow gently through the filter in the direction of the arrow to check for clogging. Replace a damaged or clogged filter.
3. Check the hoses for cracks, deterioration, abrasion, or leaks. Replace as needed. Reinstall the filter and hose clamps.

**NOTE:** The filter is effective with the arrow pointing in either direction.

### CAUTION

Operation of your vehicle without a breather filter can cause engine damage. Always reinstall the breather filter after removing it for service.

## Lights

### Headlight Beam Adjustment

The headlight beam can be adjusted slightly upward or downward. Use the following procedure to make the adjustment.

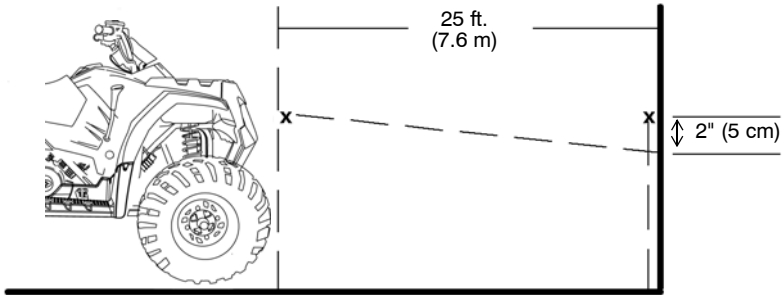

1. Position the vehicle on a level surface with the headlight approximately 25 ft. (7.6 m) from a wall.
2. Place the transmission in neutral.
3. Lock the parking brake.
4. Measure the distance from the floor to the center of the headlight and make a mark on the wall at the same height.

**NOTE:** Include rider weight on the seat when measuring.

5. Start the engine. Turn the headlight switch to high beam.
6. Observe the headlight aim on the wall. The most intense part of the headlight beam should be two inches (5 cm) below the mark on the wall.
7. Loosen the phillips screw at the rear of the headlamp.
8. Adjust the beam.
9. Tighten the screw.

# MAINTENANCE

## Lights

When servicing a halogen lamp, don't touch the lamp with bare fingers. Oil from your skin leaves a residue, causing a hot spot that will shorten the life of the lamp.

### **⚠ WARNING**

Poor lighting while driving can result in severe injury or death. Headlight and taillight lenses become dirty during normal operation. Wash the headlights frequently to maintain lighting quality.

Hot components can cause serious burns to skin. Allow lamps to cool before servicing.

## Headlamp Replacement

1. Turn the back of the headlight harness counterclockwise and pull the harness assembly away from the headlight assembly.
2. Remove the headlamp and install the new headlamp.
3. Reinstall the harness assembly into the headlight assembly.
4. Turn the headlight harness clockwise to secure the headlamp.

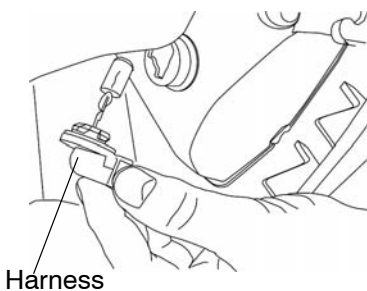

## Taillight/Brakelight Lamp Replacement

1. From the rear of the brake-light, remove the two screws holding the lens cover in place. Remove the lens cover.
2. Remove the lamp and replace it with a new lamp.
3. Test the light for proper operation.
4. Reinstall the lens cover.

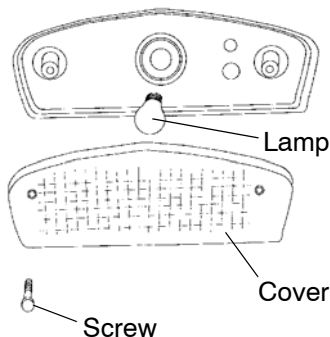



## Recoil Housing

Always drain the recoil housing after operating the vehicle in wet conditions. Drain the housing before storing the vehicle. Make sure the housing is completely dry before reinstalling the drain plug.

1. Place the transmission in gear.
2. Lock the parking brake.
3. Stop the engine.

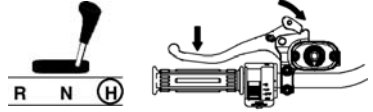

- 
4. Remove the drain screw on the bottom of the recoil housing.
  5. Reinstall the drain screw.

**NOTE:** Do not open the *crankcase* drain unless the engine has ingested water. On 4-cycle engines, some engine oil will be lost if the crankcase drain is opened.

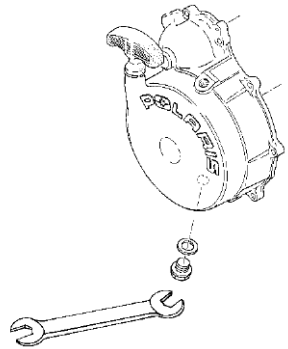

# MAINTENANCE

## Spark Plugs

### Spark Plug Recommendations

#### CAUTION

Using non-recommended spark plugs can result in serious engine damage. Always use Polaris-recommended spark plugs.

Refer to the specifications section beginning on page 126 for the recommended spark plug type and gap for your vehicle. Torque spark plugs to specification.

Plug Condition	Torque Specification
New Spark Plug	9-11 ft. lbs. (12-15 Nm)
Previously Installed Spark Plug	17-20 ft. lbs. (23-27 Nm)

### Spark Plug Inspection

Spark plug condition is indicative of engine operation. Check the spark plug firing end condition after the engine has been warmed up and the vehicle has been driven at higher speeds. Immediately check the spark plug for correct color. See page 99.

#### WARNING

A hot exhaust system and engine can cause serious burns. Wear protective gloves when removing a spark plug for inspection.

1. Remove the seat. Remove the right side panel.
2. Remove the fuel tank cover.
3. Rotate the spark plug cap 1/4 turn and pull it off the spark plug. If necessary, use a needle-nose pliers to assist.
4. Using a 5/8" socket with a long extension, access the spark plug through the fuel tank cover opening. Rotate the spark plug counterclockwise to remove it.
5. Reverse the procedure for spark plug installation. Torque to specification.

## Spark Plugs

### Spark Plug Condition

#### Normal Spark Plug

The normal insulator tip is gray, tan or light brown. There will be few combustion deposits. The electrodes are not burned or eroded. This indicates the proper type and heat range for the engine and the service.

**NOTE:** The tip should not be flaky and white. A white insulator tip indicates overheating, caused by use of an improper spark plug or incorrect carburetion adjustments.

#### Wet Fouled Spark Plug

The wet fouled insulator tip is black. A damp oil film covers the firing end. There may be a carbon layer over the entire nose. Generally, the electrodes are not worn. General causes of fouling are excessive oil, use of non-recommended oil, improper use of the choke, or incorrect throttle body/carburetor adjustments.

# MAINTENANCE

## Vehicle Immersion

### CAUTION

If your vehicle becomes immersed, major engine damage can result if the machine is not thoroughly inspected. Take the vehicle to your dealer before starting the engine.

If it's impossible to take your ATV to a dealer before starting it, follow the steps outlined below.

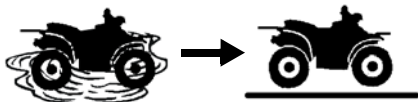

1. Move the vehicle out of the water.

2. Turn the fuel valve off.
3. Check the air box. If water is present, dry the air box and replace the filter with a new filter.
4. Remove the spark plug.



5. Loosen the carburetor drain screw and drain the carburetor.
6. Turn the engine over several times using the electric start.
7. Dry the spark plug. Reinstall the plug or install a new plug.
8. Tighten the carburetor drain screw.

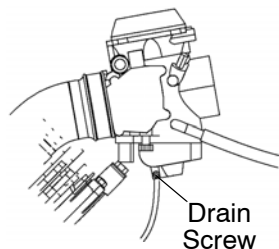

9. Turn the fuel valve on.
10. Attempt to start the engine. If necessary, repeat the drying procedure.
11. Take the ATV to your dealer for service as soon as possible, whether you succeed in starting it or not.
12. If water has been ingested into the PVT, follow the procedure on page 103 for drying out the PVT.

## Spark Arrestor

### **▲ WARNING**

Failure to heed the following warnings while servicing the spark arrestor could result in serious injury or death.

The exhaust system can get extremely hot. Do not perform service on the spark arrestor while the system is hot. Allow components to cool sufficiently before proceeding.

Remove any combustible materials from the area. Wear eye protection and leather work gloves. Do not stand behind or in front of the vehicle while purging. Never run the engine in an enclosed area. Exhaust contains poisonous carbon monoxide gas. Never go under the vehicle while it's inclined.

Use the following procedure to periodically purge accumulated carbon from the exhaust pipe/muffler.

1. Position the vehicle on a level surface.
2. Place the transmission in neutral.
3. Lock the parking brake.
4. Remove the arrestor clean-out plug from the bottom of the muffler.
5. Start the engine.
6. Quickly squeeze and release the throttle lever several times to purge carbon from the system.
7. If carbon comes out of the exhaust, cover or plug the exhaust outlet. Wear protective gloves.
8. Lightly tap on the exhaust pipe with a rubber mallet while repeating step 6.
9. If particles are still suspected to be in the muffler, elevate the rear of the vehicle one foot (30 cm) higher than the front. Block the wheels.
10. Place the transmission in neutral. Lock the parking brake. Repeat steps 6 to 8 until no more particles are expelled.
11. Stop the engine. Allow the arrestor to cool.
12. Reinstall the arrestor plug and remove the exhaust outlet cover or plug.

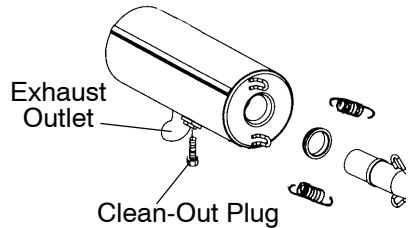

# MAINTENANCE

## PVT System

### **WARNING**

Failure to comply with the instructions in this warning can result in severe injury or death.

Do not modify any component of the PVT system. Doing so may reduce its strength so that a failure may occur at a high speed. The PVT system has been precision balanced. Any modification will cause the system to be out of balance, creating vibration and additional loads on components.

The PVT system rotates at high speeds, creating large amounts of force on clutch components. Extensive engineering and testing has been conducted to ensure the safety of this product. However, as the owner, you have the following responsibilities to make sure this system remains safe:

- Always follow all recommended maintenance procedures. See your dealer as outlined in the owner's manual.
- This PVT system is intended for use on Polaris products only. Do not install it in any other product.
- Always make sure the PVT housing is securely in place during operation.

## PVT System PVT Drying

There may be some instances when water is accidentally ingested into the PVT system. Use the following instructions to dry it out before operating.

1. Move the vehicle out of the water.

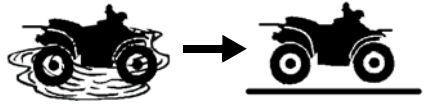

- 
2. Remove the PVT drain plug. Use a 17 mm wrench, a flat screwdriver, or the spark plug wrench.
  3. Allow the water to drain completely. Reinstall the drain plug.
  4. Start the engine. Place the transmission in neutral.
  5. Apply varying throttle for 10-15 seconds to expel the moisture and air-dry the belt and clutches.

**NOTE:** Do not hold the throttle wide open for more than 10 seconds.

6. Allow the engine RPM to settle to idle speed, then shift the transmission into forward gear.
7. Test for belt slippage. If the belt slips, repeat the process.
8. Take the vehicle to your dealer for service as soon as possible.

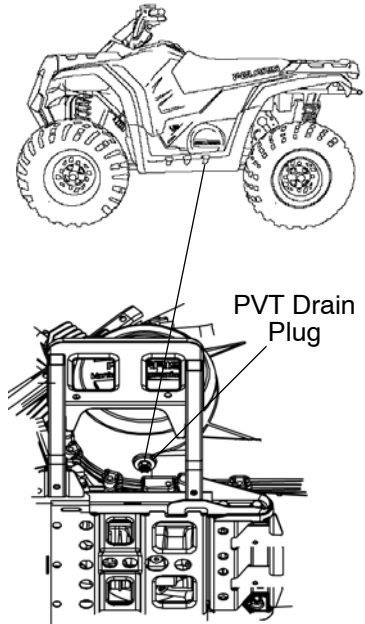

# MAINTENANCE

## Battery

Your ATV may have either a sealed battery, which requires little maintenance, or a conventional battery. A sealed battery can be identified by its flat covers on the top of the battery. A conventional battery has six filler caps on the top of the battery.

Always keep battery terminals and connections free of corrosion. If cleaning is necessary, remove corrosion with a stiff wire brush. Wash with a solution of one tablespoon baking soda and one cup water. Rinse well with tap water and dry off with clean shop towels. Coat the terminals with dielectric grease or petroleum jelly. Be careful not to allow cleaning solution or tap water into a conventional battery.

## Conventional Battery

### WARNING

Battery electrolyte is poisonous. It contains sulfuric acid. Serious burns can result from contact with skin, eyes or clothing.

Antidote:

**External:** Flush with water.

**Internal:** Drink large quantities of water or milk. Follow with milk of magnesia, beaten egg, or vegetable oil. Call physician immediately.

**Eyes:** Flush with water for 15 minutes and get prompt medical attention.

Batteries produce explosive gases. Keep sparks, flame, cigarettes, etc. away. Ventilate when charging or using in an enclosed space. Always shield eyes when working near batteries. KEEP OUT OF REACH OF CHILDREN.



## Battery

### **⚠ WARNING**

Improperly connecting or disconnecting battery cables can result in an explosion and cause serious injury or death. When removing the battery, always disconnect the negative (black) cable first. When reinstalling the battery, always connect the negative (black) cable last.

### Battery Removal

1. Place the transmission in gear.
2. Lock the parking brake.

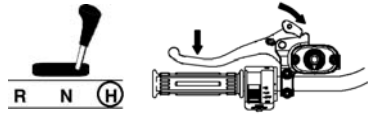

3. Remove the splash shield behind the right front tire.
4. Remove the left side panel to access the battery hold-down bracket. Remove the screw at the bottom rear of the bracket and move the bracket aside.
5. Remove the battery cover.
6. On conventional batteries, remove the battery vent tube.
7. Disconnect the black (negative) battery cable first.
8. Disconnect the red (positive) battery cable last.
9. Lift and remove the battery through the right wheel well. If using a conventional battery, be careful not to tip the battery sideways, which could spill electrolyte.

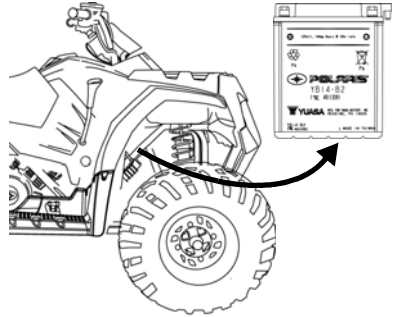

### **CAUTION**

If electrolyte spills, immediately wash it off with a solution of one tablespoon baking soda and one cup water to prevent damage to the vehicle.

# MAINTENANCE

## Battery

### Battery Installation

Using a new battery that has not been fully charged can damage the battery and result in a shorter life. It can also hinder vehicle performance. Follow the battery charging instructions on page 108 before installing the battery.

1. Ensure that the battery is fully charged.
2. Place the battery in the battery holder.
3. With conventional batteries, install the battery vent tube (sealed batteries do not have a vent tube).

**NOTE:** The vent tube must be free of obstructions and securely installed. Route the tube away from the frame and vehicle body to prevent contact with electrolyte.

### **WARNING**

Battery gases could accumulate in an improperly installed vent tube and cause an explosion, resulting in serious injury or death. Always ensure that the vent tube is free of obstructions and is securely installed as recommended.

4. Coat the terminals with dielectric grease or petroleum jelly.
5. Connect and tighten the red (positive) cable first.
6. Connect and tighten the black (negative) cable last.
7. Install the battery cover and hold-down bracket.
8. Verify that cables are properly routed.

**NOTE:** Cables should be safely tucked away at the front and rear of the battery.

9. Reinstall the left side panel and the right splash guard.

## Battery

### Battery Storage

Whenever the vehicle is not used for a period of three months or more, remove the battery from the vehicle, ensure that it's fully charged, and store it out of the sun in a cool, dry place. Check battery voltage each month during storage and recharge as needed to maintain a full charge.

**NOTE:** Battery charge can be maintained by using a Polaris Battery Tender charger or by charging about once a month to make up for normal self-discharge. Battery Tender can be left connected during the storage period, and will automatically charge the battery if the voltage drops below a pre-determined point. See page 121 for the part numbers of Polaris products.

### Battery Fluid (Conventional Battery)

A poorly maintained battery will deteriorate rapidly. Check the battery fluid level often. Maintain the fluid level between the upper and lower level marks.

Add only distilled water. Tap water contains minerals that are harmful to a battery.

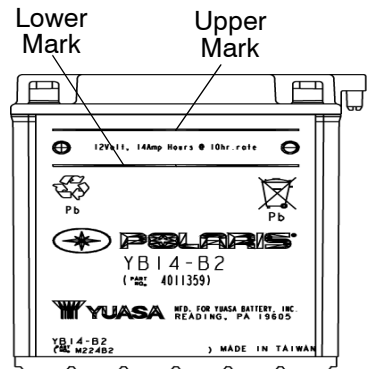

# MAINTENANCE

## Battery

### Battery Charging (Conventional Battery)

1. Remove the battery from the vehicle to prevent damage from leaking or spilled electrolyte during charging. See page 105.
2. Charge the battery with a charging output no larger than 1/10 of the battery's amp/hr rating. Charge as needed to raise the specific gravity to 1.270 or greater.
3. Reinstall the battery. See page 106. Make sure the positive terminal is toward the front of the vehicle.

### Battery Charging (Sealed Battery)

The following battery charging instructions apply only to the installation of a sealed battery. Read all instructions before proceeding with the installation of this battery.

The sealed battery is already filled with electrolyte and has been sealed and *fully charged* at the factory or dealership. *Never* pry the sealing strip off or add any other fluid to this battery.

The single most important thing about maintaining a sealed battery is to keep it fully charged. Since the battery is sealed and the sealing strip cannot be removed, you must use a voltmeter or multimeter to measure DC voltage.

#### **WARNING**

An overheated battery may explode, causing severe injury or death. Always watch charging times carefully. Stop charging if the battery becomes very warm to the touch. Allow it to cool before resuming charging.

For a refresh charge, follow all instructions carefully.

1. Check the battery voltage with a voltmeter or multimeter. A fully charged battery will register 12.8 V or higher.
2. If the voltage is less than 12.8 volts, recharge the battery at 1.2 amps or less until battery voltage is 12.8 or greater.

**NOTE:** For convenience, a charging harness has been routed from the battery to the area near the radiator filler cap. Open the front storage box cover to access the harness.

## Battery

### Battery Charging (Sealed Battery)

**NOTE:** When using an automatic charger, refer to the charger manufacturer's instructions for recharging. When using a constant current charger, use the following guidelines for recharging. Always verify battery condition before and 1-2 hours after the end of charging.

<b>State of Charge</b>	<b>Voltage</b>	<b>Action</b>	<b>Charge Time</b> (Using constant current charger @ standard amps specified on top of battery)
100%	12.8-13.0 volts	None, check at 3 mos. from date of manufacture	None required
75%-100%	12.5-12.8 volts	May need slight charge, if no charge given, check in 3 months	3-6 hours
50%-75%	12.0-12.5 volts	Needs charge	5-11 hours
25%-50%	11.5-12.0 volts	Needs charge	At least 13 hours, verify state of charge
0%-25%	11.5 volts or less	Needs charge with desulfating charger	At least 20 hours

# MAINTENANCE

## Cleaning and Storage

### Washing the Vehicle

Keeping your Polaris vehicle clean will not only improve its appearance but it can also extend the life of various components.

<b>CAUTION</b>
----------------

High water pressure may damage components. Polaris recommends washing the vehicle by hand or with a garden hose, using mild soap.
---

Certain products, including insect repellents and chemicals, will damage plastic surfaces. Do not allow these types of products to contact the vehicle.
---

The best and safest way to clean your Polaris vehicle is with a garden hose and a pail of mild soap and water.

1. Use a professional-type washing cloth, cleaning the upper body first and the lower parts last.
2. Rinse with clean water frequently.
3. Dry surfaces with a chamois to prevent water spots.

### Washing Tips

- Avoid the use of harsh cleaners, which can scratch the finish.
- Do not use a power washer to clean the vehicle.
- Do not use medium to heavy duty compounds on the finish.
- Always use clean cloths and pads for cleaning and polishing. Old or reused cloths and pads may contain dirt particles that will scratch the finish.

## Cleaning and Storage

### Washing the Vehicle

If a high pressure water system is used for cleaning (not recommended), exercise extreme caution. The water may damage components and could remove paint and decals. Avoid directing the water stream at the following items:

- Wheel bearings
- Radiator (if equipped)
- Transmission seals
- Brakes
- Cab and body panels
- Labels and decals
- Coolant (if equipped) (test strength/fill)

**NOTE:** If warning and safety labels are damaged, contact your Polaris dealer for free replacement.

Grease all zerk fittings immediately after washing. Allow the engine to run for a while to evaporate any water that may have entered the engine or exhaust system.

### Polishing the Vehicle

Polaris recommends the use of common household aerosol furniture polish for polishing the finish on your Polaris vehicle. Follow the instructions on the container.

#### Polishing Tips

- Avoid the use of automotive products, some of which can scratch the finish of your vehicle.
- Always use clean cloths and pads for cleaning and polishing. Old or reused cloths and pads may contain dirt particles that will scratch the finish.

# MAINTENANCE

## Cleaning and Storage

### Chrome Wheel Care (if equipped)

Proper maintenance will protect chrome wheels from corrosion, preserve wheel life and ensure a "like new" appearance for many years.

**NOTE:** Chrome wheels exposed to road salt (or salt in the air in coastal areas) are more susceptible to corrosion if not properly cleaned. Clean chrome wheels more often if they're exposed to salt or other corrosive elements.

1. Wash chrome wheels frequently. Use a mild detergent. Never use abrasive cleaners on plated or painted surfaces.
2. Rinse well with clear water. Soap, detergents, salt, dirt, mud and other elements can cause corrosion.
3. Polish the clean chrome wheels periodically. Use an automotive grade chrome polish.
4. Routinely and liberally apply a weather resistant wax to each polished chrome wheel. Choose a product suitable for chrome finishes. Read and follow the product labels and instructions.

### Removing Corrosion

If light rust is found on the chrome finish, use steel wool (#0000-OTT grade) to remove it. Gently rub the affected areas with the steel wool until the corrosion has been removed. Clean and polish the wheel as outlined above.



## Cleaning and Storage Storage Tips

### CAUTION

Starting the engine during the storage period will disturb the protective film created by fogging and damage could occur. Never start the engine during the storage period.

### Clean the Exterior

Make any necessary repairs and clean the vehicle as recommended. See page 110.

### Stabilize the Fuel

1. Fill the fuel tank.
2. Add Polaris Carbon Clean Fuel Treatment or Polaris Fuel Stabilizer. Follow the instructions on the container for the recommended amount.

**NOTE:** Carbon Clean removes water from fuel systems, stabilizes fuel and removes carbon deposits from pistons, rings, valves and exhaust systems.

3. Allow the engine to run for 15-20 minutes to allow the stabilizer to disperse through the fuel in the tank and carburetor.
4. Turn the fuel valve off.
5. Drain the carburetor bowl.

### Oil and Filter

Change the oil and filter. See page 76.

### Air Filter / Air Box

1. Inspect and clean (or replace) the pre-cleaner and air filter.
2. Clean the air box.
3. Clean or replace the breather filter. See page 94.
4. Drain the sediment tube.

### Recoil Housing

1. Drain the recoil housing. See page 97.

# MAINTENANCE

## Cleaning and Storage

### Storage Tips

#### Fluid Levels

Inspect the fluid levels. Change fluids as recommended in the Periodic Maintenance Chart beginning on page 68.

- Demand drive unit (front gearcase)
- Transmission
- Brake fluid (change every two years and any time the fluid looks dark or contaminated)

#### Fog the Engine

1. Treat the fuel system with Polaris Carbon Clean. See page 113.
2. Support the front end of the machine so the engine is level or tilted slightly rearward.
3. Remove the spark plug. Rotate the piston to BDC and pour two ounces (59 ml) of engine oil into the cylinder.
4. Reinstall the spark plug. Torque to specification.
5. Apply dielectric grease to the inside of the spark plug cap. Reinstall the cap.
6. Turn the engine over several times using the recoil starter. Oil will be forced in and around the piston rings and ring lands, coating the cylinder with a protective film of fresh oil.
7. If Polaris fuel system additive is not used, the fuel tank, fuel lines, and carburetor should be completely drained of gasoline.

## Cleaning and Storage

### Storage Tips

#### Inspect and Lubricate

Inspect all cables and lubricate all areas of the vehicle as recommended in the Periodic Maintenance Chart beginning on page 68.

#### Battery Storage

See pages 107-108 for storage and charging procedures.

#### Storage Area/Covers

Set the tire pressure and safely support the ATV with the tires slightly off the ground. Be sure the storage area is well ventilated. Cover the vehicle with a genuine Polaris cover.

**NOTE:** Do not use plastic or coated materials. They do not allow enough ventilation to prevent condensation, and may promote corrosion and oxidation.

## Accessories

Auxiliary power outlets provide 12-volt power for operating accessories. Accessory outlets are available for all models. Polaris also has a wide range of additional accessories available for your ATV. Always install accessories that are approved for ATV use. Please see your Polaris dealer.

# MAINTENANCE

## Transporting the Vehicle

Follow these procedures when transporting the vehicle.

1. Stop the engine.
2. Place the transmission in gear.
3. Lock the parking brake.
4. Turn the fuel valve off.
5. Secure the fuel cap, oil cap and seat.
6. Remove the key to prevent loss during transporting.
7. Always tie the frame of the ATV to the transporting unit securely with suitable straps or rope. Do not attach tie straps to the front A-arm bolt pockets.

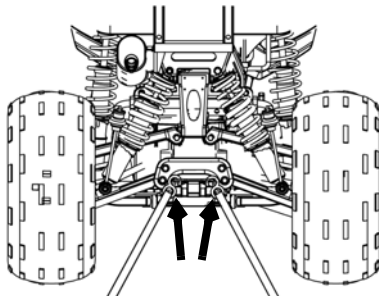
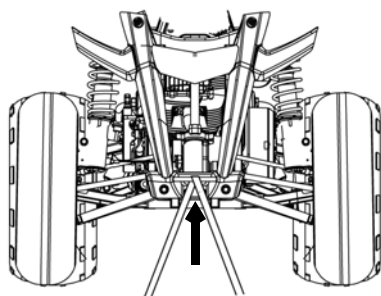

# ADJUSTMENTS

## Camber and Caster

The camber and caster are non-adjustable.

## Spring Adjustments

The front and rear shock absorber springs are adjustable. Rotate the adjuster either clockwise or counterclockwise to increase or decrease spring tension. Always adjust both sides equally.

**NOTE:** Accessory springs are available through your Polaris dealer.

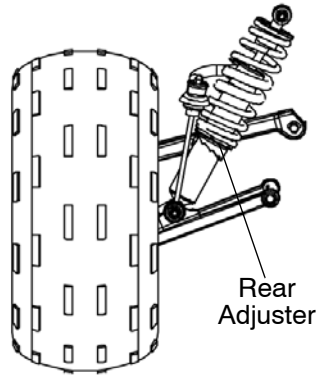
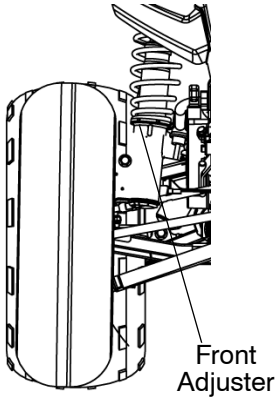

# ADJUSTMENTS

## Handlebars

The handlebars can be adjusted for rider preference.

### **⚠ WARNING**

Improper adjustment of the handlebars or incorrect torquing of the adjuster block tightening bolts can cause limited steering or loosening of the handlebars, resulting in loss of control and possible serious personal injury or death. Follow the adjustment procedures exactly, or see your Polaris dealer for service.

1. Loosen the four handlebar bolts.
2. Adjust the handlebar to the desired height.

**NOTE:** Be sure the handlebars do not contact the gas tank or any other part of the machine when turned fully to the left or right.

3. Torque the front two bolts to 10-12 ft. lbs. (14-17 Nm), then torque the rear two bolts. A gap of up to 1/8" (3 mm) will remain at the rear bolts.

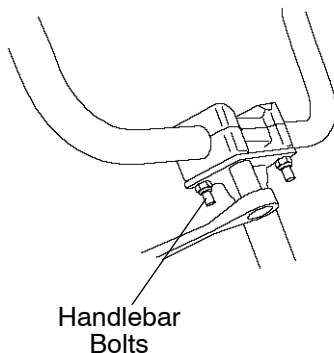

# ADJUSTMENTS

## Carburetor

Your Polaris ATV is calibrated at the factory for optimal performance at altitudes ranging from zero to 6,000 feet (1800 m) and temperatures of +40 degrees F. (4 degrees C.) or higher. Above 6000 feet (1800 m) the engine air/fuel mixture becomes overly rich and the engine loses approximately 3% of its power for each 1000-foot (304.8 m) increase in elevation. Although this power cannot be regained, adjustments to the carburetor and drive system can be made to allow more efficient operation. Optional jets, available from your Polaris dealer, are required for operation above 6,000 feet and temperatures below +40 degrees F. (4 degrees C.)

**NOTE:** Continuous operation of the engine without proper jetting when required can cause poor performance, overheating or PVT or engine damage. See your Polaris dealer for more information about jetting the ATV for conditions in your area.

## Carburetor/Engine Idle RPM Adjustment

If the engine idle speed is not satisfactory, and all other conditions are favorable, the carburetor can be adjusted.

1. Place the transmission in gear.
2. Lock the parking brake.

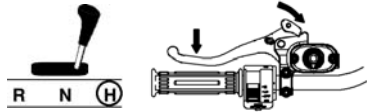

3. Start the engine and allow it to warm up for approximately five minutes.
4. Turn the screw in (clockwise) to raise RPM. Turn the screw out (counterclockwise) to lower RPM.

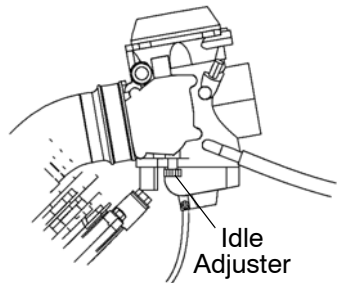

# ADJUSTMENTS

## Throttle Cable Freeplay

Adjust throttle cable freeplay at the handlebar.

1. Locate the throttle cable adjuster at the handlebar.
2. Squeeze the end of the rubber boot and slide it far enough to expose the end of the inline cable adjuster.
3. Loosen the adjuster lock nut.
4. Rotate the boot to turn the adjuster until  $1/16''$  to  $1/8''$  (1.5-3 mm) of freeplay is achieved at the thumb lever.

**NOTE:** While adjusting freeplay, be sure to flip the throttle lever back and forth.

5. Tighten the lock nut.
6. Squeeze the end of the rubber boot and slide it over the cable adjuster to its original position.

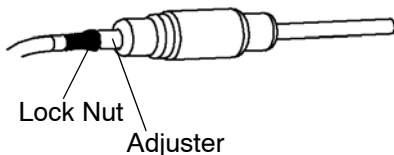
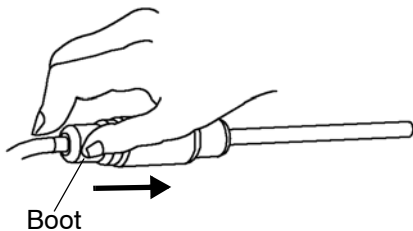
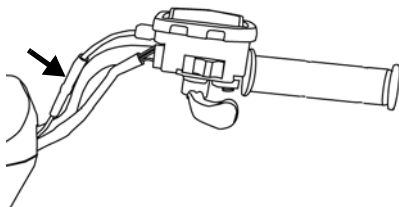



# POLARIS PRODUCTS

<b>Part Number</b>	<b>Description</b>
<b>Engine Lubricant</b>	
2870791	Fogging Oil (12 oz. Aerosol)
2876244	PS-4 PLUS Performance Synthetic 2W-50 4-Cycle Oil (qt.)
2876245	PS-4 PLUS Performance Synthetic 2W-50 4-Cycle Oil (gal.)
<b>Gearcase / Transmission Lubricants</b>	
2873602	Premium AGL Synthetic Gearcase Lubricant (qt.)
2873603	Premium AGL Synthetic Gearcase Lube (gal.)
2870465	Pump for Gallon Jug
2871654	Premium Demand Drive Hub Fluid (8 oz.)
2872277	Premium Demand Drive Hub Fluid (2.5 gal.)
<b>Coolant</b>	
2871323	60/40 Coolant (gal./3.8 l)
2871534	60/40 Coolant (qt./.95 l)
<b>Grease / Specialized Lubricants</b>	
2871312	Grease Gun Kit, Premium All Season (3 oz.)
2871322	Premium All Season Grease (3 oz. cartridge)
2871423	Premium All Season Grease (14 oz. cartridge)
2871460	Starter Drive Grease (2 oz.)
2871515	Premium U-Joint Lube (3 oz.)
2871551	Premium U-Joint Lube (14 oz.)
2871329	Dielectric Grease (Nyogel™)
2872073	Chain Lube, Aerosol (6.25 oz.)
2872348	Chain Lube, Aerosol (16 oz.)
<b>Additives / Miscellaneous</b>	
2871326	Carbon Clean Plus (12 oz.)
2870652	Fuel Stabilizer (16 oz.)
2872189	DOT4 Brake Fluid (12 oz.)
2871956	Loctite™ 565 Thread Sealant
2859044	Polaris Battery Tender™ Charger

# TROUBLESHOOTING

## Drive Belt Wear/Burn

Possible Cause	Solution
Driving onto a pickup or tall trailer in high range	Use low range (if equipped).
Starting out going up a steep incline	Use low range (if equipped) or turn around using the K-turn (see page 60).
Driving at low RPM or ground speed (3-7 MPH)	Drive at a higher speed or use low range (if equipped) more frequently.
Insufficient warm-up at low ambient temperatures	Warm the engine at least 5 minutes. With the transmission in neutral, advance the throttle to about 1/8 throttle in short bursts, 5 to 7 times. The belt will become more flexible and prevent belt burning.
Slow/easy clutch engagement	Use the throttle quickly and effectively.
Towing/pushing at low RPM/low ground speed	Use low range only (if equipped).
Utility use/plowing	Use low range only (if equipped).
Stuck in mud or snow	Shift the transmission to low range (if equipped). Carefully use fast, aggressive throttle application to engage clutch. <b>WARNING:</b> Excessive throttle may cause loss of control and vehicle overturn.
Climbing over large objects from a stopped position	
Belt slippage from water or snow ingestion into the PVT system	Dry out the PVT. See page 103. Inspect clutch seals for damage if repeated leaking occurs.
Clutch malfunction	See your Polaris dealer.
Poor engine performance	Check for fouled plugs or foreign material in gas tank or fuel lines. See your dealer.
Slippage from failure to warm up belt	Always warm up the belt by operating below 30 mph (48 km/h) for one mile (1.6 km). Operate 5 miles (8 km) or more when temperature is below freezing.
Wrong or missing belt	Install the recommended belt.
Improper break-in	Always break in a new belt and/or clutch. See page 48.

# TROUBLESHOOTING

## Engine Doesn't Turn Over

Possible Cause	Solution
Blown fuse	Replace fuse
Low battery voltage	Recharge the battery to 12.8 VDC
Loose battery connections	Check all connections and tighten
Loose solenoid connections	Check all connections and tighten

## Engine Turns Over, Fails to Start

Possible Cause	Solution
Out of fuel	Refuel, cycle key to ON position three times for 5 seconds each, then start
Clogged fuel valve or filter	Inspect and clean or replace
Water is present in fuel	Drain the fuel system and refuel
Fuel valve is turned off	Turn the fuel valve on
Old or non-recommended fuel	Replace with fresh recommended fuel
Fouled or defective spark plug(s)	Inspect plugs and replace if necessary
No spark to spark plug	Inspect plugs, verify stop switch is on
Overuse of choke	Inspect, clean and/or replace spark plugs
Water or fuel in crankcase	Immediately see your Polaris dealer
Low battery voltage	Recharge the battery to 12.8 VDC
Mechanical failure	See your dealer

## Engine Backfires

Possible Cause	Solution
Weak spark from spark plug	Inspect, clean and/or replace spark plug(s)
Incorrect spark plug gap or heat range	Set gap to specs or replace plugs
Old or non-recommended fuel	Replace with fresh recommended fuel
Incorrectly installed spark plug wires	See your dealer
Incorrect ignition timing	See your dealer
Mechanical failure	See your dealer

# TROUBLESHOOTING

## Engine Pings or Knocks

Possible Cause	Solution
Poor quality or low octane fuel	Replace with recommended fuel
Incorrect ignition timing	See your dealer
Incorrect spark plug gap or heat range	Set gap to specs or replace plugs
Idle set too low	Adjust idle speed

## Engine Runs Irregularly, Stalls or Misfires

Possible Cause	Solution
Fouled or defective spark plug(s)	Inspect, clean and/or replace spark plug(s)
Worn or defective spark plug wires	See your dealer
Incorrect spark plug gap or heat range	Set gap to specs or replace plugs
Loose ignition connections	Check all connections and tighten
Water present in fuel	Replace with new fuel
Low battery voltage	Recharge battery to 12.8 VDC
Kinked or plugged fuel tank vent line	Inspect and replace
Incorrect fuel	Replace with recommended fuel
Clogged air filter	Inspect and clean or replace
Reverse speed limiter malfunction	See your dealer
Electronic throttle control malfunction	See your dealer
Other mechanical failure	See your dealer
Possible Lean Fuel Cause	Solution
Low or contaminated fuel	Add or change fuel, clean the fuel system
Low octane fuel	Replace with recommended fuel
Clogged fuel filter	Replace filter
Incorrect jetting	See your dealer
Possible Rich Fuel Cause	Solution
Overuse of choke	Inspect, clean and/or replace spark plugs
Fuel is very high octane	Replace with lower octane fuel
Incorrect jetting	See your dealer

# TROUBLESHOOTING

## Engine Stops or Loses Power

Possible Cause	Solution
Out of fuel	Refuel, cycle key to ON position three times for 5 seconds each, then start
Kinked or plugged fuel vent line	Inspect and replace
Water is present in fuel	Replace with new fuel
Overuse of choke	Inspect, clean and/or replace spark plugs
Fouled or defective spark plug(s)	Inspect, clean and/or replace spark plug(s)
Worn or defective spark plug wires	See your dealer
Incorrect spark plug gap or heat range	Set gap to specs or replace plug
Loose ignition connections	Check all connections and tighten
Low battery voltage	Recharge the battery to 12.8 VDC
Incorrect fuel	Replace with fresh recommended fuel
Clogged air filter	Inspect and clean or replace
Reverse speed limiter malfunction	See your dealer
Electronic throttle control malfunction	See your dealer
Other mechanical failure	See your dealer
Overheated engine	Clean radiator screen and core, clean engine exterior, see your dealer

## Engine Overheating

Possible Cause	Solution
Low radiator coolant level	Add coolant.
Debris lodged in screen	Remove and clean the screen. Pull on the top portion of the screen, then remove the lower portion.
Plugged Radiator	Use a garden hose to flush any debris from the radiator fins. NOTE: High pressure washers can deform the radiator fins and reduce cooling efficiency.
Obstructed cooling fan	Clean any debris or mud that may be interfering with fan movement.

# SPECIFICATIONS

## Sportsman 400 HO 4X4

Maximum Weight Capacity	365 lbs. (166 kg) (includes weight of operator, cargo and accessories)
Dry Weight	598 lbs. (271 kg)
Fuel Capacity	4.5 gal. (17 l)
Engine Oil Capacity	2 qts. (1.9 l)
Coolant Capacity	2.2 qts. (2 l)
Transmission Oil	20.3 oz. (600 ml)
Demand Drive Fluid	5 oz. (148 ml)
Front Rack Capacity	70 lbs. (32 kg)
Rear Rack Capacity	100 lbs. (45 kg)
Hitch Tongue Weight Capacity	75 lbs. (34 kg) (Rear rack capacity and tongue weight not to exceed 100 lbs./45 kg)
Hitch Towing Rating	750 lbs. (340.2 kg)
Unbraked Trailer Towing Capacity*	1786 lbs. (810 kg)
Overall Length	73 in. (185 cm)
Overall Width	44 in. (112 cm)
Overall Height	46 in. (117 cm)
Wheelbase	46 in. (117 cm)
Ground Clearance	9 in. (23 cm)
Minimum Turning Radius	69 in. (175 cm) unloaded
Engine Model Number/Type	EH460PLE020/4-Cycle, Single Cylinder
Lubrication	Dry sump
Engine Cooling	Liquid
Displacement	455 cc
Bore x Stroke	78.5 x 68
Alternator Output	250 w
Compression Ratio	10.1:1
Carburetor	34mm CV Mikuni
Pilot Jet	42.5
Main Jet	157.5
Needle Jet	P-6M (829)
Jet Needle	4IB33
Pilot Air Jet	160
Engine Idle	1350 RPM
Ignition System	DC CDI
Ignition Timing	14° +/- 2° @ 1500 RPM/30° +/- 2° @ 5000 RPM
Spark Plug / Gap	NGK BKR6E / .035 in. (0.9 mm)

\* Based on EU Directive 76/432/EC

# SPECIFICATIONS

## Sportsman 400 HO 4X4

Driving System Type	Automatic PVT (Polaris Variable Transmission)
Shift Type	Side Lever (H/N/R)
Drive Ratio, Front	3.6:1
Drive Ratio, Final	15.18:1
Tires/Pressure	Front 24x8-12 / 5 psi (34.5 KPa) Rear 24x11-12 / 5 psi (34.5 KPa)
Front Suspension	MacPherson strut with 7" (18 cm) travel
Rear Suspension	Progressive rate with 8" (20 cm) travel
Shock Adjustment	CAM
Brakes, Front and Rear	Single-Control Hydraulic Disc
Brake, Auxiliary	Foot-Activated Hydraulic Disc, Rear Wheel
Brake, Parking	Hydraulic lock, all wheel
Headlight	2 Dual Beam on Bumper (37.5 watt)
Taillights	12V 8.26W
Brake Light	12V 26.9W
Battery	12V 14AH
DC Plug-In (rear)	Accessory
Windshield	Accessory
Speedometer/Odometer/ Tripmeter/Hour Meter	Standard
Fuel Gauge	Standard

### Jetting Chart

ALTITUDE Meters (Feet)	AMBIENT TEMPERATURE	
	Below 40° F (Below 5° C)	+40°F and above (+5°C and above)
0-1800 (0-6000)	162.5	157.5
Above 1800 (6000)	150	145

### Clutching Chart

Altitude Meters (Feet)	Roller Weight	Number of Rollers	Driven Clutch Spring
0-1500 (0-5000)	19.5 g / 5413447	8	7043228
1500-3000 (5000-10000)	17 g / 5412975	8	7043228
3000+ (10000+)	16 g / 5412991	8	7043228

# **WARRANTY**

## **LIMITED WARRANTY**

Polaris Sales Inc., 2100 Highway 55, Medina, MN 55340, gives a **SIX MONTH LIMITED WARRANTY** on all components of the Polaris All Terrain Vehicle (ATV) against defects in material or workmanship. Polaris also gives a one year limited warranty on the final drive chain for failure due to defects. This warranty covers the parts and labor charges for repair or replacement of defective parts which are covered by this warranty. This warranty begins on the date of purchase. This warranty is transferable to another consumer during the warranty period through a Polaris dealer.

## **REGISTRATION**

At the time of sale, the Warranty Registration Form must be completed by your dealer and submitted to Polaris within ten days. Upon receipt of this registration, Polaris will record the registration for warranty. No verification of registration will be sent to the purchaser as the copy of the Warranty Registration Form will be the warranty entitlement. If you have not signed the original registration and received the customer copy, please contact your dealer immediately. **NO WARRANTY COVERAGE WILL BE ALLOWED UNLESS YOUR ATV IS REGISTERED WITH POLARIS.**

Initial dealer preparation and set-up of your ATV is very important in ensuring trouble-free operation. Purchasing a machine in the crate or without proper dealer set-up will void your warranty coverage.



# WARRANTY

## WARRANTY COVERAGE AND EXCLUSIONS: LIMITATIONS OF WARRANTIES AND REMEDIES

The Polaris limited warranty excludes any failures that are not caused by a defect in material or workmanship. This warranty does not cover accidental damage, normal wear and tear, abuse or improper handling. This warranty also does not cover any ATV that has been altered structurally, modified, neglected, improperly maintained, used for racing, or used for purposes other than for which it was manufactured, or for any damages which occur during trailer transit or as a result of unauthorized service or the use of unauthorized parts. In addition, this warranty does not cover physical damage to paint or finish, stress cracks, tearing or puncturing of upholstery material, corrosion, or defects in parts, components or the ATV due to fire, explosions or any other cause beyond Polaris' control.

This warranty does not cover the use of unauthorized lubricants, chemicals, or fuels that are not compatible with the ATV. The exclusive remedy for breach of this warranty shall be, at Polaris' exclusive option, repair or replacement of any defective materials, or components or products. THE REMEDIES SET FORTH IN THIS WARRANTY ARE THE ONLY REMEDIES AVAILABLE TO ANY PERSON FOR BREACH OF THIS WARRANTY. POLARIS SHALL HAVE NO LIABILITY TO ANY PERSON FOR INCIDENTAL, CONSEQUENTIAL OR SPECIAL DAMAGES OF ANY DESCRIPTION, WHETHER ARISING OUT OF EXPRESS OR IMPLIED WARRANTY OR ANY OTHER CONTRACT, NEGLIGENCE, OR OTHER TORT OR OTHERWISE. Some states do not permit the exclusion or limitation of incidental or consequential damages or implied warranties, so the above limitations or exclusions may not apply to you if inconsistent with controlling state law.

# WARRANTY

ALL IMPLIED WARRANTIES (INCLUDING BUT NOT LIMITED TO THE IMPLIED WARRANTIES OF MERCHANTABILITY AND FITNESS FOR A PARTICULAR PURPOSE) ARE LIMITED IN DURATION TO THE ABOVE SIX MONTH WARRANTY PERIOD. POLARIS FURTHER DISCLAIMS ALL EXPRESS WARRANTIES NOT STATED IN THIS WARRANTY. Some states do not allow limitations on how long an implied warranty lasts, so the above limitation may not apply to you if inconsistent with controlling state law.

## HOW TO OBTAIN WARRANTY SERVICE

If your ATV requires warranty service, you must take it to a Polaris dealer authorized to repair Polaris ATVs. When requesting warranty service you must present your copy of the Warranty Registration form to the dealer. (THE COST OF TRANSPORTATION TO AND FROM THE DEALER IS YOUR RESPONSIBILITY). Polaris suggests that you use your original selling dealer; however, you may use any Polaris Servicing Dealer to perform warranty service.

Please work with your dealer to resolve any warranty issues. Should your dealer require any additional assistance they will contact the appropriate person at Polaris.

This warranty gives you specific legal rights, and you may also have other rights which vary from state to state.

If any of the above terms are void because of state or federal law, all other warranty terms will remain in effect.

### Engine Oil

1. Mixing oil brands or using non-recommended oil may cause engine damage. We recommend the use of Polaris engine oil for your ATV.
2. Damage resulting from the use of non-recommended lubricants may not be covered by warranty.

### SPARK ARRESTOR

Polaris warrants that the spark arrestor in this vehicle will meet the efficiency requirements of 43 CFR 8340.1(c) for at least 1000 hours when subjected to normal use and when maintenance and installation are in accordance with Polaris recommendations.

## Exported Vehicles

EXCEPT WHERE SPECIFICALLY REQUIRED BY LAW, THERE IS NO WARRANTY OR SERVICE BULLETIN COVERAGE ON THIS VEHICLE IF IT IS SOLD OUTSIDE THE COUNTRY OF THE SELLING DEALER'S AUTHORIZED LOCATION.

This policy does not apply to vehicles that have received authorization for export from Polaris Industries. Dealers may not give authorization for export. You should consult an authorized dealer to determine this vehicle's warranty or service bulletin coverage if you have any questions.

This policy does not apply to vehicles registered to government officials or military personnel on assignment outside the country of the selling dealer's authorized location.

This policy does not apply to Safety Recalls.

## How to Get Service

### *In the Country where your vehicle was purchased:*

Warranty or Service Bulletin repairs must be done by an authorized Polaris dealer. If you move or are traveling within the country where your vehicle was purchased, Warranty or Service Bulletin repairs may be requested from any authorized Polaris dealer who sells the same line as your vehicle.

### *Outside the Country where your vehicle was purchased:*

If you are traveling temporarily outside the country where your vehicle was purchased, you should take your vehicle to an authorized Polaris dealer. You must show the dealer photo identification from the country of the selling dealer's authorized location as proof of residence. Upon residence verification, the servicing dealer will be authorized to perform the warranty repair.

### *If You Move:*

If you move to another country, be sure to contact Polaris Customer Assistance and the customs department of the destination country before you move. Vehicles importation rules vary considerably from country to country. You may be required to present documentation of your move to Polaris Industries in order to continue your warranty coverage. You may also be required to obtain documentation from Polaris Industries in order to register your vehicle in your new country.

# WARRANTY

## Exported Vehicles

### How to Get Service

#### *If Purchased From A Private Party:*

If you purchase a Polaris product from a private citizen outside of the country in which the vehicle was originally purchased, all warranty coverage will be denied.

#### **Notice**

If your vehicle is registered outside of the country where it was purchased, and you have not followed the procedure set out above, your vehicle will no longer be eligible for warranty or service bulletin coverage of any kind. (Vehicles registered to Government officials or military personnel on assignment outside of the country where the vehicle was purchased will continue to be covered by the basic warranty.)

#### *For questions call Polaris Customer Assistance:*

United States: 1-888-704-5290

Canada: 1-204-925-7100

# WARRANTY

## U.S.A. EPA Emissions Limited Warranty

This All Terrain Vehicle (ATV) or Off Road Utility Vehicle (ORUV) emissions limited warranty is in addition to the Polaris standard limited warranty for this vehicle.

Polaris warrants that this vehicle is; (1) designed, built, and equipped to conform at the time of initial sale with the requirements of 40 CFR 1051 and, (2) free from defects in materials and workmanship that may keep it from meeting these requirements.

The emissions warranty period for this vehicle begins on the date the vehicle is delivered to the original retail purchaser and ends 30 months (2.5 years) after that date, after 5000 km (3100 miles), or after 500 hours of operation, whichever comes first.

This emission-related warranty covers components whose failure would increase an engine's emissions, including electronic controls, fuel injection, exhaust-gas recirculation, aftertreatment, or any other system utilized in this vehicle to control emissions. Replacing or repairing other components not covered by this emissions warranty or the standard warranty is the responsibility of the owner; including the parts, labor and other costs associated with recommended maintenance.

The exclusive remedy for breach of this limited warranty shall be, at the exclusive option of Polaris, repair or replacement of any defective materials, components or products. THE REMEDIES SET FORTH IN THIS LIMITED WARRANTY ARE THE ONLY REMEDIES AVAILABLE TO ANY PERSON FOR BREACH OF THIS WARRANTY. POLARIS SHALL HAVE NO LIABILITY TO ANY PERSON FOR INCIDENTAL, CONSEQUENTIAL OR SPECIAL DAMAGES OF ANY DESCRIPTION, WHETHER ARISING OUT OF EXPRESS OR IMPLIED WARRANTY OR ANY OTHER CONTRACT, NEGLIGENCE OR OTHER TORT OR OTHERWISE.

ALL IMPLIED WARRANTIES (INCLUDING BUT NOT LIMITED TO ANY IMPLIED WARRANTIES OF MERCHANTABILITY AND FITNESS FOR A PARTICULAR PURPOSE) ARE LIMITED IN DURATION TO THE WARRANTY PERIOD DESCRIBED HEREIN. POLARIS DISCLAIMS ALL EXPRESS WARRANTIES NOT STATED IN THIS WARRANTY. Some states do not allow limitations on how long an implied warranty lasts, so the above limitation may not apply if it is inconsistent with the controlling state law.

This limited warranty excludes failures not caused by a defect in material or workmanship. This limited warranty does not cover damage due to accidents, abuse or improper handling, maintenance or use. This limited warranty also does not cover any engine that has been structurally altered, or any engine that has been used in racing competition. This limited warranty also does not cover physical damage, corrosion or defects caused by fire, explosions or other similar causes beyond the control of Polaris.

If you have any questions regarding your warranty rights and responsibilities, you should contact the Polaris Warranty Department at 1-888-704-5290.

# MAINTENANCE LOG

Present this section of your manual to your dealer each time your vehicle is serviced. This will provide you and future owners with an accurate log of maintenance and services performed.

<b>DATE</b>	<b>MILES (KM) OR HOURS</b>	<b>TECHNICIAN</b>	<b>SERVICE PERFORMED / COMMENTS</b>



## Free Manuals Download Website

<http://myh66.com>

<http://usermanuals.us>

<http://www.somanuals.com>

<http://www.4manuals.cc>

<http://www.manual-lib.com>

<http://www.404manual.com>

<http://www.luxmanual.com>

<http://aubethermostatmanual.com>

Golf course search by state

<http://golfingnear.com>

Email search by domain

<http://emailbydomain.com>

Auto manuals search

<http://auto.somanuals.com>

TV manuals search

<http://tv.somanuals.com>