

WELCOME

Thank you for purchasing a Polaris vehicle, and welcome to our world-wide family of Polaris owners. We proudly produce an exciting line of utility and recreational products.

- Snowmobiles
- All-terrain vehicles (ATVs)
- Quadricycles
- *RANGER* utility vehicles
- Victory motorcycles

Always follow the instructions and recommendations in this manual. The manual contains instructions for minor maintenance, but information about major repairs is outlined in the Polaris Service Manual and should be performed only by a Factory Certified Master Service Dealer (MSD) Technician. Please see your dealer for all of your service needs during (and after) the warranty period.

For more information about Polaris, visit us online at www.polarisindustries.com.



POLARIS[®]
The Way Out.

POLARIS and POLARIS THE WAY OUT are registered trademarks of Polaris Industries Inc.

Copyright 2007 Polaris Sales Inc. All information contained within this publication is based on the latest product information at the time of publication. Due to constant improvements in the design and quality of production components, some minor discrepancies may result between the actual vehicle and the information presented in this publication. Depictions and/or procedures in this publication are intended for reference use only. No liability can be accepted for omissions or inaccuracies. Any reprinting or reuse of the depictions and/or procedures contained within, whether whole or in part, is expressly prohibited.

Printed in U.S.A.

2008 Sportsman 800 Touring Quadricycle Owner's Manual

P/N 9921454

TABLE OF CONTENTS

Know Your Vehicle	5
Safety	6
Features and Controls	20
Operation	41
Emission Control Systems	64
Maintenance	65
Specifications	118
Polaris Products	120
Troubleshooting	121
Warranty	125
Maintenance Log	128
Index	130

KNOW YOUR VEHICLE

As the operator of the vehicle, you are responsible for your personal safety, the safety of others (including your passenger), and the protection of our environment. Read and understand your owner's manual, which includes valuable information about all aspects of your vehicle, including safe operating procedures.

Ride responsibly. Know all laws and regulations concerning the operation of this vehicle in your area.

Vehicle Identification Numbers

Record your vehicle's identification numbers and key number in the spaces provided. Remove the spare key and store it in a safe place. An ignition key can be duplicated only by ordering a Polaris key blank (using your key number) and mating it with one of your existing keys. The ignition switch must be replaced if all keys are lost.

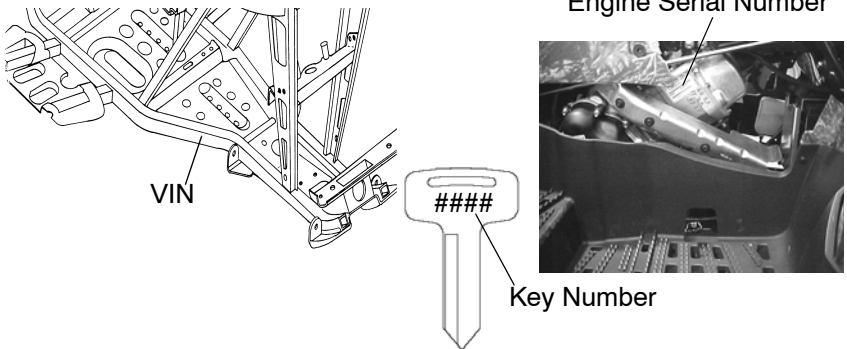

Vehicle Model Number: _____

Frame VIN: _____

Engine Serial Number: _____

Key Number: _____

SAFETY

Rider Safety

The following signal words and symbols appear throughout this manual and on your vehicle. Your safety is involved when these words and symbols are used. *Become familiar with their meanings before reading the manual.*



The *safety alert symbol*, on your vehicle or in this manual, alerts you to the potential for injury.

WARNING

The *safety alert warning* indicates a potential hazard that may result in serious injury or death.

CAUTION

The *safety alert caution* indicates a potential hazard that may result in minor injury or damage to the vehicle.

CAUTION

A *caution* indicates a situation that may result in damage to the vehicle.

NOTE

A *note* will alert you to important information or instructions.

Rider Safety

WARNING

Failure to follow the warnings in this manual can result in serious injury or death. A Polaris Quadricycle is not a toy and can be hazardous to operate. A collision or rollover can occur quickly, even during routine maneuvers, if you fail to take proper precautions.

Read and understand your owner's manual and all warnings before operating a Polaris Quadricycle.

Safety Training

When you purchased your new Quadricycle, your dealer offered a hands-on safety training course. You were also provided with printed materials that explain safe operating procedures. Review this information on a regular basis.

If you purchased a used Polaris Quadricycle from a party other than a Polaris dealer, please request free safety training from any authorized Polaris dealer.

Age Restrictions

This vehicle is an **ADULT VEHICLE ONLY**. Operation is prohibited for anyone under 16 years of age. Never allow anyone under 12 years of age to ride as a passenger on this 2-up Quadricycle.

Restrictions

This vehicle is approved for **OFF-ROAD TOWING ONLY**. Operating a Quadricycle/trailer combination on public roads is prohibited. See your Polaris dealer about configuring the vehicle to be certified to tow a trailer on-road.

Equipment Modifications

The warranty on your Polaris Quadricycle may be terminated if any equipment has been added, or if any modifications have been made, that increase speed or power.

NOTE: The addition of certain accessories, including (but not limited to) mowers, blades, tires, sprayers and large racks may change vehicle handling. Use only Polaris-approved accessories. Know their function and effect on the vehicle.

SAFETY

Rider Safety

WARNING

Serious injury or death can result if you do not follow the instructions and procedures listed here and throughout this manual.



Read and understand all warnings, cautions and operating procedures in this manual and on the safety labels before operating the Quadricycle.

Never operate a Quadricycle without proper instruction. *Take a training course.* Beginners should receive training from a certified instructor. Contact an authorized Polaris Quadricycle dealer or visit the Polaris web site at www.polarisindustries.com.

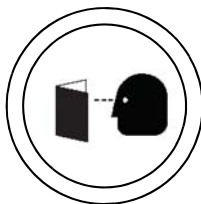

Never permit others to operate the Quadricycle unless they have read and understand this manual and all product labels, and have completed a certified safety training course.



Never allow anyone under 16 years of age to operate this vehicle.

Never allow anyone under 12 years of age to ride as a passenger on this 2-up Quadricycle.

Never carry more than one passenger on this 2-up Quadricycle.



Rider Safety

Always wear an approved helmet that fits properly. Wear eye protection (goggles or face shield), gloves, boots, long sleeves and long pants.

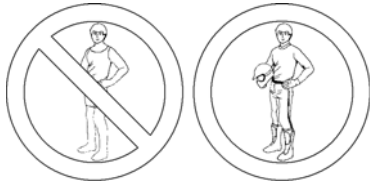

Never consume alcohol or drugs before or while operating a Quadricycle.



Never operate at excessive speeds. Travel and turn at speeds appropriate for the terrain, visibility, operating conditions and your experience.



Never attempt jumps or other stunts.



SAFETY

Rider Safety

Always inspect your Quadricycle before each use to verify that it's in safe operating condition. Follow the inspection and maintenance procedures outlined in this manual. See page 43.

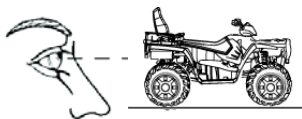

Keep both hands on the handlebars. Keep both feet on the footrests.

A passenger should always be seated in the passenger seat with both feet on the footrests and both hands on the passenger grab handles at all times. The passenger should never hold on to the operator.



Always travel slowly when operating on unfamiliar terrain. Use extra caution.



Use caution when operating on rough, slippery or loose terrain.



Always follow the procedures outlined in this manual for turning. See page 47.

Never turn sharply at excessive speeds, which can lead to vehicle overturn.

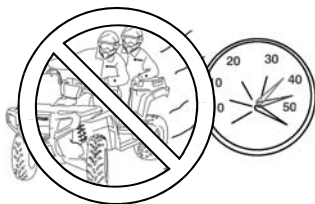

Rider Safety

If a Quadricycle has been involved in an accident, always have an authorized Polaris dealer inspect the entire vehicle for possible damage, including (but not limited to) brake, throttle and steering systems.



Always follow the procedures outlined in this manual for driving on hills. See page 50. Never operate on hills too steep for the Quadricycle or for your abilities. Practice on smaller hills before attempting larger hills. Avoid climbing hills steeper than 15°.

Never operate with the differential unlocked (🔓) while operating on a hill or other irregular terrain. See pages 23 and 31. Always move the 4X4 switch to ADC 4X4 before ascending or descending a hill.

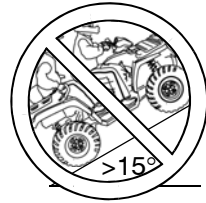

Always follow the procedures outlined in this manual for driving downhill and for braking on hills. See page 53.

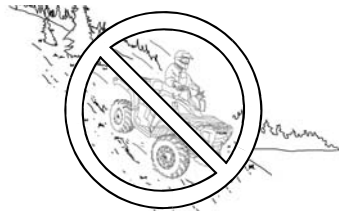

Always follow the procedures outlined in this manual for crossing the side of a hill. See page 52.

Never attempt to turn the Quadricycle around on any hill until you've mastered (on level ground) the turning technique outlined in this manual.



SAFETY

Rider Safety

Always follow the procedures outlined in this manual for braking if you stall or roll backwards while climbing a hill. Never back down a hill. See page 54.



Always follow the procedures outlined in this manual for operating over obstacles. See page 59.



Always follow the procedures outlined in this manual for operating on slippery or loose surfaces. Use extra caution. Always avoid skidding or sliding. See page 58.



Always follow the procedures outlined in this manual for driving through water. Never drive through deep or fast-flowing water. See page 56.



Rider Safety

Always follow the procedures outlined in this manual for driving in reverse. See page 61.



Always use the size and type of tires specified for your vehicle. Maintain the proper tire pressure.

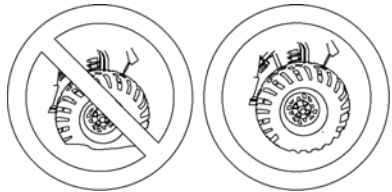

Never modify a Quadricycle through improper installation or use of accessories.

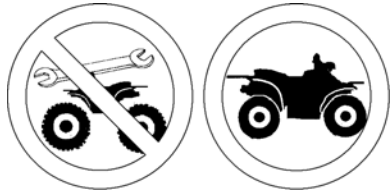

Never exceed the stated load capacity for your vehicle. Cargo must be properly distributed and securely attached. Reduce speed and follow the instructions in this manual for carrying cargo or towing. Allow a greater distance for braking.



SAFETY

Rider Safety

Never operate the Quadricycle on a frozen body of water.



Operating on paved surfaces may affect the handling and control of the Quadricycle and could result in loss of control. Avoid sudden turns or swift movement of the handlebars.



Always remove the ignition key when the vehicle is not in use to prevent unauthorized use or accidental starting.

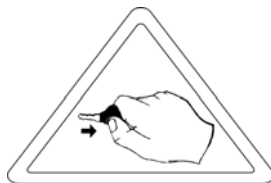

Always unlock the steering before starting the engine. See page 27.



Hot components can cause serious burns and fire. Do not touch hot exhaust system components. Always keep combustible materials away from the exhaust system.



For more information about Quadricycle safety, contact an authorized Polaris Quadricycle dealer or visit the Polaris web site at www.polarisindustries.com.

Safety Decals and Locations

Warning decals have been placed on the vehicle for your protection. Read and follow the instructions on each decal carefully. If a decal becomes illegible or comes off, contact your Polaris dealer to purchase a replacement. Replacement safety decals are provided by Polaris at no charge. The part number is printed on the decal.

The following pages repeat the information found on each decal.

General Alert (Multi-Lingual)

Before you operate or ride this vehicle, read the owner's manual.



General Alert

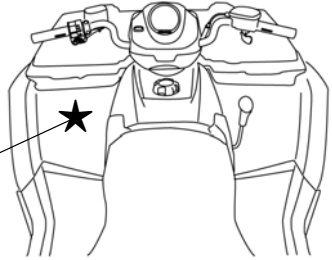

Hill Operation Alert

- Never operate this vehicle on HILLS steeper than 15 degrees $\leq 15^\circ$.
- To prevent flip-over on hilly terrain, when going up or down, use throttle and brakes gradually.

Age 16
Alert



Hill
Operation
Alert

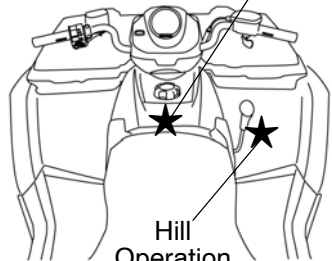

SAFETY

Safety Decals and Locations

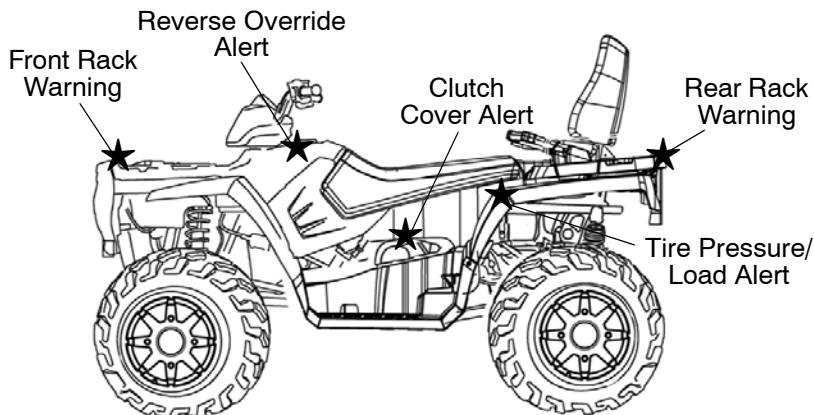

Tire Pressure/Load Alert

TIRE PRESSURE IN PSI (KPa): FRONT 5 (34.5) REAR 5 (34.5)

MAXIMUM WEIGHT CAPACITY 568 LBS. (258 kg)

INCLUDES WEIGHT OF OPERATOR, PASSENGER, CARGO AND ACCESSORIES.

Read Owner's Manual for more detailed loading information.



Reverse Override Alert

Pushing reverse override button may cause sudden increases in power and traction if too much throttle is applied. Loss of control or forward flipover may result, especially in 4X4 (AWD). See Owner's Manual.

Safety Decals and Locations



Rack Warning, Front and Rear

WARNING

DO NOT TOW FROM RACK OR BUMPER. Vehicle damage or tipover may result causing severe injury or death. Tow only from tow hooks or hitch.
Maximum Rack Loads: Front 90 lbs. (41 kg) Rear 180 lbs. (82 kg)



Clutch Cover Alert

NO STEP



SAFETY

Safe Riding Gear

Always wear protective clothing to reduce the chance of injury.

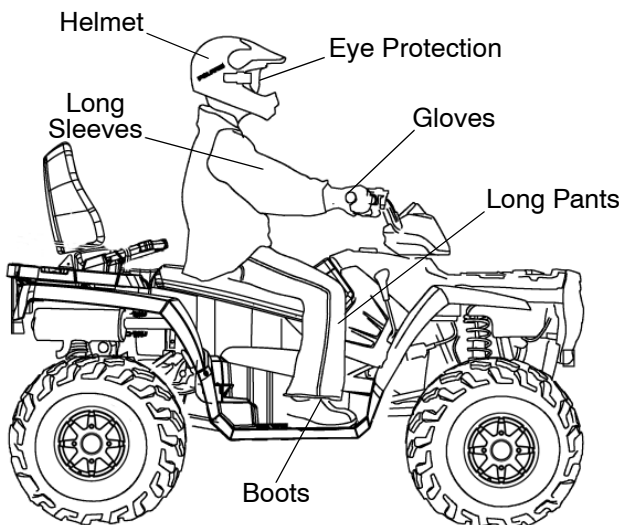

Helmet

Always wear a helmet that meets or exceeds established safety standards.

Approved helmets in the USA and Canada bear a U.S. Department of Transportation (DOT) label.

Approved helmets in Europe, Asia and Oceania bear the ECE 22.05 label. The ECE mark consists of a circle surrounding the letter E, followed by the distinguishing number of the country which has granted approval. The approval number and serial number will also be displayed on the label.

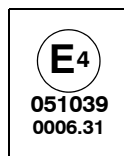

Safe Riding Gear

Eye Protection

Do not depend on eyeglasses or sunglasses for eye protection. When ever riding a Polaris vehicle, always wear shatterproof goggles or use a shatterproof helmet face shield. Polaris recommends wearing approved Personal Protective Equipment (PPE) bearing markings such as VESC 8, V-8, Z87.1, or CE. Make sure protective eye wear is kept clean.

Gloves

Off-road style gloves with knuckle pads are the best for comfort and protection.

Boots

The best footwear is a pair of sturdy over-the-calf boots with low heels.

Clothing

Always wear long sleeves and long pants to protect arms and legs. Riding pants with kneepads and a jersey with shoulder pads provide the best protection.

FEATURES AND CONTROLS

Switches

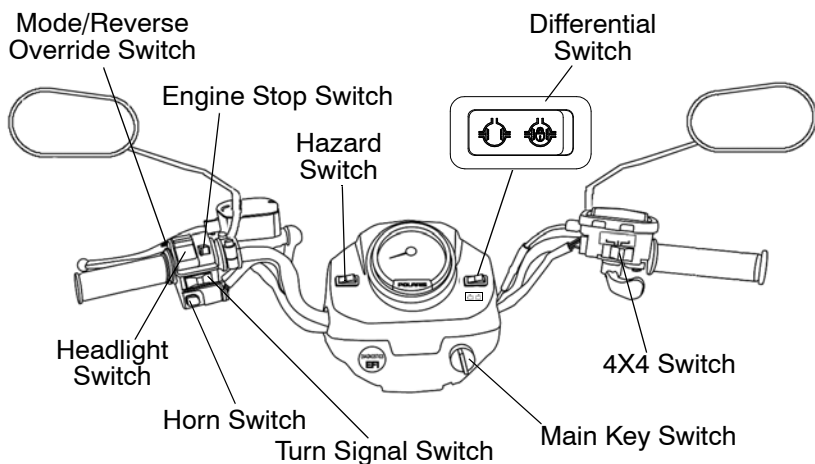

Mode/Reverse Override Switch

Press the switch to toggle through the speedometer display modes (except in reverse). See page 32.

To gain additional power while operating in reverse, press the override switch before opening the throttle. This will cancel the reverse speed limit function.

NOTE: The override switch also allows activation of 4X4 in reverse, if the 4X4 switch is on.





▲ WARNING

Activating the override switch while the throttle is open can cause loss of control, resulting in severe injury or death. Do not activate the override switch while the throttle is open.

FEATURES AND CONTROLS

Switches

Main Key Switch



-  End all electrical power to the vehicle.
-  *LIGHTS ON* position turns the headlights on.
-  Start the engine. The headlights are not on in this position.
-  After starting the engine, release the key switch to the *POSITION LIGHTS ON* position.



Do not attach a large key fob or key ring to the main switch. It may contact the gas tank cap when turning, causing an interruption to the electrical system and an unexpected engine shut-down during operation. This could result in serious injury or death.



Engine Stop Switch

The engine will not start or run when the switch is in the OFF position.

-  OFF
-  RUN

Light Switch

The lights do not operate unless the main key switch is on and the engine stop switch is in the RUN position.

-  High Beam
-  Low Beam

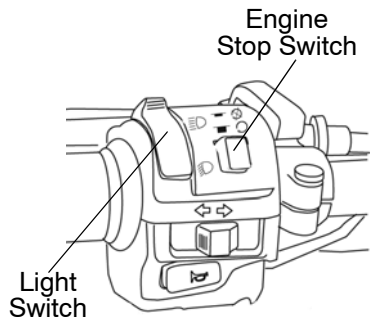

FEATURES AND CONTROLS

Switches

4X4 Switch

Use the 4X4 switch to engage ADC 4X4, 4X4 or 2X4. See page 30.

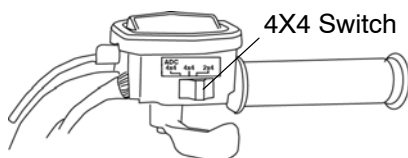

Hazard Warning Switch

⚠ Push the hazard warning switch to cause all turn signal lights to flash simultaneously. Use this feature to alert others of an emergency or other situation requiring caution.

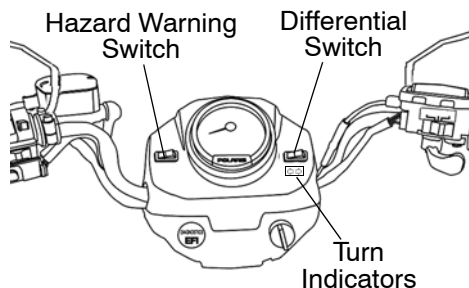

Turn Signal Switch

↔ Push the toggle switch either left or right to activate the corresponding turn signal light. The indicator on the pod will also flash. Return the toggle to the center position and push it inward to end the signal.

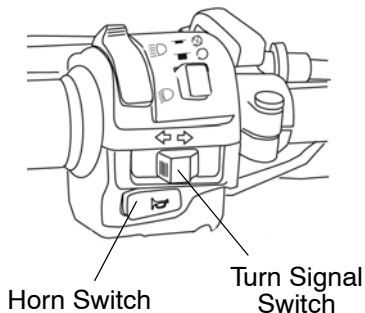

Horn Switch

🔊 Press the horn switch to sound the horn.

FEATURES AND CONTROLS

Switches

Differential Switch

Use the differential switch to lock and unlock the rear differential.



Locked Differential: Operate the vehicle with the switch in the locked position in most conditions.



Unlocked Differential: When the differential is unlocked, the inside wheel will rotate independently from the outside wheel during turns. Operate with an unlocked differential only as needed to protect smooth, level surfaces from tire damage. Otherwise, move the switch to the locked position. *This feature will function only if the vehicle is in 2X4 mode.*



Operating with the differential unlocked (🔓) when on sloped, uneven, or loose terrain could cause loss of control and result in serious injury or death. One rear wheel may slip and lose traction or may lift up and grab when it touches the ground again.

DO NOT operate with the differential unlocked (🔓) when climbing or descending hills, when sidehilling, or when operating on uneven, loose, or slippery terrain such as sand, gravel, ice, snow, obstacles, and water crossings. Place the differential switch in the locked position and operate in ADC 4X4 or 4X4 on these types of terrain.

FEATURES AND CONTROLS

Throttle Lever

Press the throttle lever to increase engine speed and vehicle movement. Release the lever to reduce engine speed and vehicle movement.



▲ WARNING

Failure to check or maintain proper operation of the throttle system can result in an accident if the throttle lever sticks during operation. Check the lever for proper operation before starting the engine. Check occasionally during operation.

Do not start or operate a Quadricycle with sticking or improperly operating throttle controls. Contact your dealer for repair if throttle problems arise.

Mirrors

Use the mirrors to assist in traffic maneuvers. Always check and adjust the mirrors before driving the Quadricycle.

Electronic Throttle Control (ETC)

ETC causes the engine to stop if the throttle cable sticks in an open position when the operator releases the throttle lever.

Electronic Throttle Control

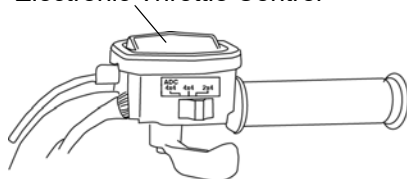

The Electronic Throttle Control (ETC) stops the engine in the event of a throttle system malfunction. Do not modify the ETC system or replace it with other throttle mechanisms.

FEATURES AND CONTROLS

Foot Brake

The all-wheel foot brake is located on the right footrest. The foot brake operates both front and rear brakes. Press the brake pedal down with your foot to apply the all-wheel brakes.

If the rear wheels begin to skid or slide while using the foot brake, reduce brake pressure.

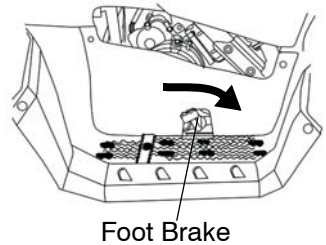

Hand Brake Lever

The hand brake operates both front and rear brakes. Squeeze the brake lever toward the handlebar to apply the all-wheel brakes.

If the rear wheels begin to skid or slide while using the brake, reduce lever pressure.

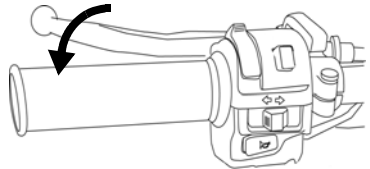

⚠ WARNING

Aggressively applying the brakes when backing down a hill may cause rear tipover. Aggressively applying the brakes while moving forward may cause the rear wheels to skid and result in loss of control.

Read this owner's manual and understand the operation of all brake systems on this vehicle. Always use caution whenever applying the brakes.

FEATURES AND CONTROLS

Parking Brake

Locking the Parking Brake

1. Place the transmission in PARK.
2. Squeeze the brake lever toward the handlebar.
3. Push the parking brake lock forward to engage the lock. Release the brake lever.
4. To release the parking brake lock, squeeze and release the brake lever.

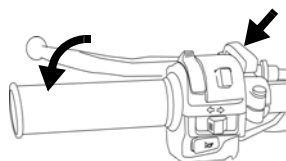

⚠ WARNING

Operating the Quadricycle while the parking brake is engaged could result in an accident and serious injury or death. Always release the parking brake lock before operating.

FEATURES AND CONTROLS

Steering Lock

Lock the steering to prevent unauthorized use or theft of the vehicle.

1. Turn the handlebars to the full right position.

NOTE: The handlebars may also be locked in the full left position.

2. Insert the steering lock key and turn it clockwise.
3. Remove the key.

NOTE: Place the steering lock keys in a safe place. The lock must be replaced if the keys are lost.

4. Reverse the procedure to unlock the steering.

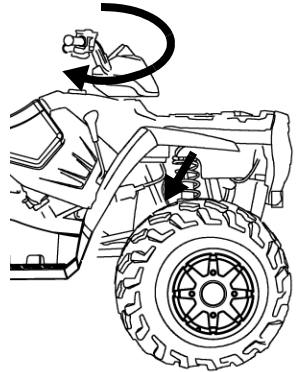

The handlebars are locked in the fully turned position when the steering is locked. Always unlock the steering before starting the engine.

FEATURES AND CONTROLS

Fuel Tank Cap

Remove the fuel tank cap to add fuel to the fuel tank. Use either leaded or unleaded gasoline with a minimum pump octane of 87. *Do not use E-85 fuel.*

Fuel Filter

The in-line fuel filter should be replaced by your dealer after every 100 hours of operation or annually. Do not attempt to clean the fuel filter.

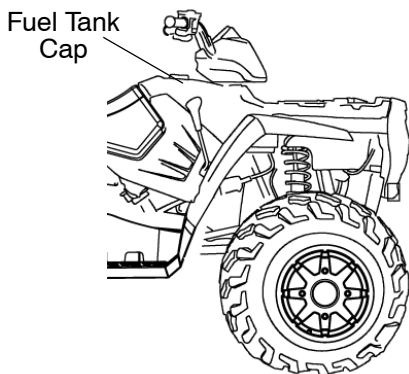

FEATURES AND CONTROLS

Automatic Transmission Gear Selector

The transmission gear selector is located on the right side of the vehicle.

H: High Gear

L: Low Gear

N: Neutral

R: Reverse

P: Park

Whenever the vehicle is left unattended, always place the transmission in PARK. The transmission is locked when it's in PARK.

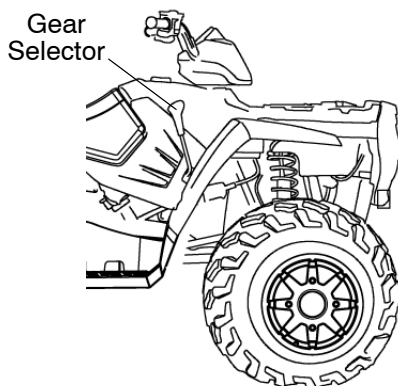

Shifting gears with the engine speed above idle or while the vehicle is moving can cause transmission damage. Stop the vehicle, release the throttle and move the shift lever to the desired gear. See your dealer if you experience any shifting problems.

Passenger Seat

Always make sure the passenger seat is installed and securely latched before operating with a passenger. Test the seat latch by attempting to pull the seat upward.

Latch



NOTE: If the latch is not working properly, do not allow a passenger to ride the vehicle. See your Polaris dealer for service.

To remove the seat, pull the latch loop at the rear of the seat. Pull the seat upward to remove it from the vehicle.

To reinstall the seat, make sure the rubber feet at the base of the seat are positioned in the rear rack. Press down firmly on the seat pad until the latch clicks

FEATURES AND CONTROLS

All Wheel Drive (4X4) System

The All Wheel Drive system is controlled by the 4X4 switch.

ADC 4X4

When the switch is on ADC 4X4, the ADC system allows engine braking to all four wheels when the vehicle descends a hill or incline.

Always move the 4X4 switch to ADC 4X4 before ascending or descending a hill. See page 31.

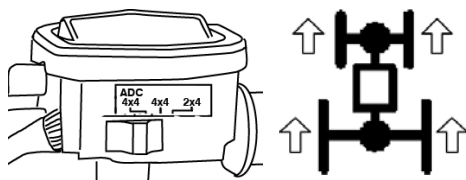

4X4

When the switch is on 4X4, the vehicle is in 4X4, and the 4X4 indicator light in the instrument cluster will be on.

When in 4X4, the demand drive unit will automatically engage any time the rear wheels lose traction. When the rear wheels regain traction, the demand drive unit will automatically disengage. There is no limit to the length of time the vehicle may remain in 4X4.

NOTE: The override switch allows activation of 4X4 in reverse if the 4X4 switch is on. See page 20.

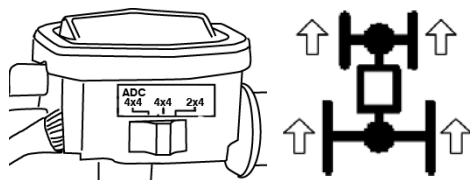

2X4

When the switch is on 2X4, the vehicle is in two-wheel drive at all times.

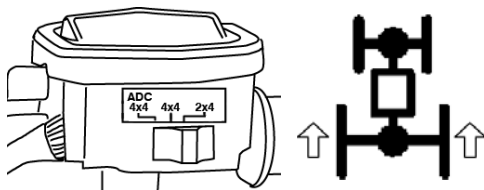

FEATURES AND CONTROLS

All Wheel Drive (4X4) System

Engaging 4X4

The 4X4 switch may be turned on or off while the vehicle is moving. 4X4 will not engage until engine speed is below 3100 RPM. 4X4 remains engaged until the switch is turned off. There is no limit to the length of time the vehicle may remain in 4X4.

If the switch is turned off while the demand drive unit is engaged, it will not disengage until the rear wheels regain traction. Engage 4X4 before getting into situations where maximum traction is needed. If the rear wheels are spinning, release the throttle before switching to 4X4.



Switching to 4X4 or ADC 4X4 while the rear wheels are spinning may cause severe drive shaft and gearcase damage. Always switch to 4X4 or ADC 4X4 while the rear wheels have traction or are at rest.

Active Descent Control (ADC) System

The ADC system allows engine braking to all four wheels when the vehicle descends a hill or incline. Always move the 4X4 switch to ADC 4X4 before ascending or descending a hill.

Engaging Active Descent Control

The ADC system will automatically engage when *all four* of the following conditions occur:

- The 4X4 switch must be in the ADC 4X4 position
- Vehicle speed must be 24 km/h or less
- The throttle must be closed (throttle lever released)
- The transmission must be in gear (high, low or reverse)

Disengaging Active Descent Control

The ADC system will automatically disengage if *at least one* of the following conditions occur:

- The 4X4 switch is moved out of the ADC 4X4 position
- Vehicle speed exceeds 24 km/h
- The throttle is open (throttle is applied)
- The transmission is shifted to neutral or park

FEATURES AND CONTROLS

Instrument Cluster

The instrument cluster senses vehicle speed from the transmission. The instrument cluster measures distance in miles or kilometers, as well as hours of operation. It also includes a reverse speed limiter function that limits the vehicle's speed to approximately 11-14 km/h. Refer to page 20 for additional information.

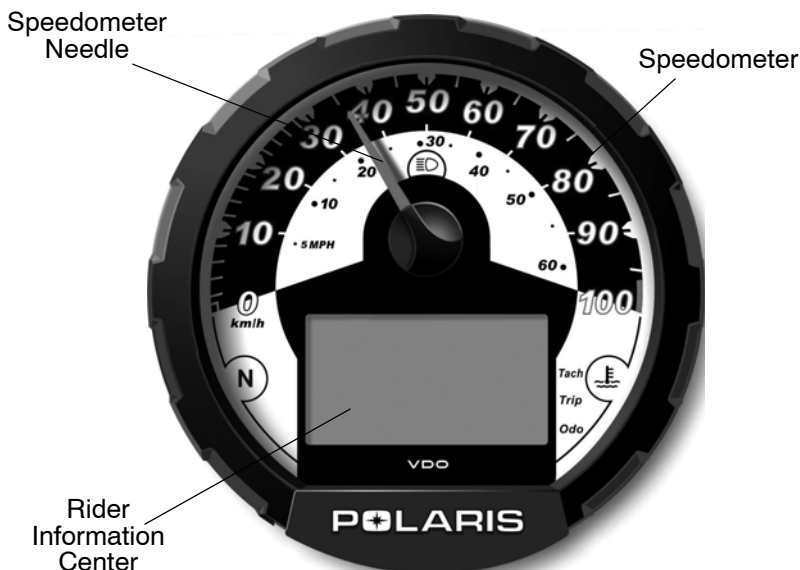

NOTE: In addition to showing vehicle speed, the speedometer needle flashes when a warning condition exists.



High water pressure may damage vehicle components. Wash the vehicle by hand or with a garden hose using mild soap.

Certain products, including insect repellents and chemicals, will damage the speedometer lens and other plastic surfaces. Do not use alcohol to clean the instrument cluster. Do not allow insect sprays to contact the lens. Immediately clean off any gasoline that splashes on the instrument cluster.

FEATURES AND CONTROLS

Instrument Cluster

Rider Information Center

The rider information center is located in the instrument cluster. All segments will light up for 2.5 seconds at start-up.

NOTE: If the instrument cluster fails to illuminate, a battery over-voltage may have occurred and the instrument cluster may have shut off to protect the electronic speedometer. If this occurs, take the vehicle to your Polaris dealer for proper diagnosis.

1. **Gear Indicator** - This indicator displays gear shifter position:
H = High Gear
L = Low Gear
N = Neutral
R = Reverse Gear
P = Park

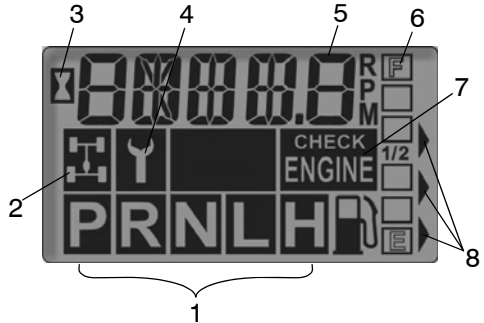

2. **4X4 Indicator** - This indicator illuminates when the 4X4 switch is on either ADC 4X4 or 4X4.
3. **Engine Hour Display Indicator**
4. **Service Interval/Diagnostic Mode Indicator**
5. **Odometer/Tachometer/Tripmeter/ Hour Meter/Clock**
6. **Fuel Gauge** - The segments of the fuel gauge show the level of fuel in the fuel tank. When the last segment clears, a low fuel warning is activated. All segments will flash, FUEL will display in the LCD, and the speedometer needle will blink. Refuel immediately.
7. **Check Engine Warning Indicator** - This indicator serves two purposes. The word HOT displays if the engine overheats. It also appears if an EFI-related fault occurs. Do not operate the vehicle if this warning appears. Serious engine damage could result.
8. **Mode Indicator**

FEATURES AND CONTROLS

Instrument Cluster

Rider Information Center

Standard Modes

Use the MODE button to toggle through the mode options. The reverse override button is also the MODE button. See page 20.

NOTE: The transmission cannot be in reverse when using this feature.

Odometer Mode

The odometer records the miles or kilometers traveled by the Quadricycle.

Trip Meter Mode

The trip meter records the miles or kilometers traveled by the Quadricycle on each trip if it's reset before each trip. To reset the trip meter, select the trip meter mode. Press and hold the mode button (override button) until the total changes to 0.

NOTE: In the Rider Information Center, the trip meter display contains a decimal point, but the odometer displays without a decimal point.

Hour Meter Mode

This mode logs the total hours the engine has been in operation.

Tachometer Mode

The engine RPM is displayed digitally.

NOTE: Small fluctuations in the RPM from day to day may be normal because of changes in humidity, temperature and elevation.

Clock Mode

The clock displays time in a 12-hour format. To reset the clock, see page 35.

FEATURES AND CONTROLS

Instrument Cluster

Rider Information Center

Diagnostic Mode

The wrench icon will display when the gauge is in the diagnostic mode. To exit the diagnostic mode, turn the key switch off and on. Any movement of the tires will also cause the gauge to exit the diagnostic mode.

To enter the diagnostics mode:

1. Turn the key switch off and wait 10 seconds.
2. Lock the parking brake.
3. Place the transmission in neutral.
4. Hold the mode/reverse override button and turn the key switch on. Release the switch as soon as the display is activated.
5. Use the mode button to toggle through the diagnostic screens.

Clock Screen

To reset the clock:

1. Enter the diagnostic mode.
2. Toggle to the clock screen.
3. Press and hold the mode button until the hour display flashes. Release the button.
4. Press and release the mode button once to advance the setting by one hour. Press and *hold* the mode button to advance the hours quickly.
5. When the desired hour is displayed, wait approximately four seconds, until the minute display flashes.
6. Use the same procedure to reset the minutes.
7. When the display stops flashing, the mode has been set.

NOTE: Do not turn the key switch off until the display stops flashing or the new setting will not be locked into the memory.

FEATURES AND CONTROLS

Instrument Cluster

Rider Information Center

Diagnostic Mode

Battery Voltage Screen

View this screen to check battery voltage level.

Tachometer Screen

View the tachometer to check engine speed.

4X4 Diagnostic Screen

The gauge indicates whether or not current is flowing through the 4X4 coil (only on models with switchable 4X4). This screen is for informational purposes only. Please see your dealer for all major repairs.

Gear Circuit Diagnostic Screen

This screen displays the resistance value (in ohms) being read at the gear switch input of the gauge. This screen is for informational purposes only. Please see your dealer for all major repairs.

Programmable service interval

When the hours of engine operation equal the programmed service interval setting, the wrench icon will flash for 5 seconds each time the engine is started. When this feature is enabled, it provides a convenient reminder to perform routine maintenance. See page 37.

NOTE: The service interval is programmed at 50 hours at the factory.

FEATURES AND CONTROLS

Instrument Cluster

Rider Information Center

Diagnostic Mode

Programmable service interval

To enable or disable the service interval:

1. Enter the diagnostic mode.
2. Toggle to the service interval screen.
3. Press and hold the mode button for about 7 seconds, until either ON or OFF appears in the Rider Information Center, depending on your preference.

To reset the service interval:

1. Enter the diagnostic mode.
2. Toggle to the service interval screen.
3. Press and hold the mode button for 2-3 seconds, until the wrench icon flashes. Release the button.
4. Press and release the mode button once to advance the setting by one hour. Press and *hold* the mode button to advance the hours quickly.

NOTE: If you scroll past the intended number, press and hold the button until the hours cycle back to zero.

5. When the desired setting is displayed, wait until the wrench icon stops flashing. The new service interval is now programmed.

FEATURES AND CONTROLS

Instrument Cluster

Rider Information Center

Diagnostic Mode

Miles/Kilometers toggle

The display in the tripmeter and odometer can be changed to display either standard or metric units of measurement.

1. Enter the diagnostic mode.
2. Toggle to the screen that displays either kilometers (KM) or miles (MP).
3. Press and hold the mode button until the letters flash, then press and release the button once. When the display stops flashing, the mode has been set.

Downloading Codes

The EFI diagnostic mode is for informational purposes only. Please see your Polaris dealer for all major repairs.

See page 40 for Blink Codes and Failure Descriptions. Use the following procedure to download blink codes (failure codes) from the EFI module.

1. Place the transmission in PARK. Stop the engine. Turn the key switch to the ON position.
2. Turn the key switch off and on three times in less than five seconds. The word "WAIt" will appear on the screen.

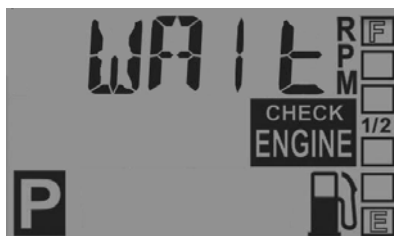

FEATURES AND CONTROLS

Instrument Cluster

Rider Information Center

Downloading Codes

3. The Check Engine icon will blink once, pause, then blink twice (blink code 12) to begin the diagnostic sequence. The EFI module is now searching for blink codes. If a code exists, the Check Engine icon will flash the code.
4. Count the number of times the Check Engine icon flashes.

Example: For the two blink codes 42 and 36, the Check Engine icon will flash 4 times, pause, then flash 2 times (code 42), then pause longer, blink 3 times, pause, and blink 6 times (code 36).

5. A code 61 will signal the end of the sequence. If no blink codes are found, only codes 12 and 61 will appear during the sequence.

NOTE: The word "WAIT" will remain on the screen through this entire process.

Code Definitions

Open Load: There is a break in the wires that lead to the item listed in the chart (injector, fuel pump, etc.), or the item has failed.

Short-to-Ground: The wire is shorted to ground between the electronic control unit and the item listed in the chart.

Shorted Load: The wires leading to the item listed in the chart are shorted together, or the item has shorted internally.

Short-to-Battery: The wire leading from the item listed in the chart to the electronic control unit is shorted to a wire at battery voltage.

FEATURES AND CONTROLS

Instrument Cluster

Rider Information Center

Downloading Codes

Blink Code	Failure Description
12	BEGIN SEQUENCE
22	Throttle Position Sensor Low
22	Throttle Position Sensor High
25	Gear Sensor Signal
31	System Voltage Low
31	System Voltage High
36	Ignition Coil A Prim/Sec Circuit Malfunction: Open Load/Short-to-Ground
36	Ignition Coil A Prim/Sec Circuit Malfunction: Shorted Load/Short-to-Battery
37	Ignition Coil B Prim/Sec Circuit Malfunction: Open Load/Short-to-Ground
37	Ignition Coil B Prim/Sec Circuit Malfunction: Shorted Load/Short-to-Battery
41	Air Temp Sensor Low Voltage
41	Air Temp Sensor High Voltage
42	Engine Coolant Temp Low Voltage
42	Engine Coolant Temp High Voltage
44	Crank Position Sensor Circuit Fault
45	Barometric Pressure/Manifold Air Pressure Sensor Low
46	Barometric Pressure/Manifold Air Pressure Sensor High
47	IAC Stepper Motor: Open Load
47	IAC Stepper Motor: Short-to-Ground
51	Injector Circuit Malfunction - Cyl 1: Open Load/Short-to-Ground
51	Injector Circuit Malfunction - Cyl 1: Shorted Load/Short-to-Battery
52	Injector Circuit Malfunction - Cyl 2: Open Load/Short-to-Ground
52	Injector Circuit Malfunction - Cyl 2: Shorted Load/Short-to-Battery
55	MIL Circuit: Open Load/Short-to-Ground
55	MIL Circuit: Shorted Load/Short-to-Battery
56	Fuel Pump: Open Load/Short-to-Ground
56	Fuel Pump: Shorted Load/Short-to-Battery
58	Fan Circuit: Open Load/Short-to-Ground
58	Fan Circuit: Shorted Load/Short-to-Battery
59	ADC: Open Load/Short-to-Ground
59	ADC: Shorted Load/Short-to-Battery
63	Starter Enable: Open Load/Short-to-Ground
63	Starter Enable: Shorted Load/Short-to-Battery
72	Gear Sensor Signal
73	4X4: Open Load/Short-to-Ground
73	4X4: Shorted Load/Short-to-Battery
74	Rear Differential Enable: Open Load/Short-to-Ground
74	Rear Differential Enable: Shorted Load/Short-to-Battery
61	END SEQUENCE

Fuel Safety

WARNING

Gasoline is highly flammable and explosive under certain conditions.

- Use extreme caution whenever handling gasoline.
- Refuel with the engine stopped. Refuel outdoors or in a well-ventilated area.
- Never fill a fuel container while it's on the vehicle. Static electricity between the rack and container could cause a spark.
- Do not smoke or allow open flames or sparks in or near the area where refueling is performed or where gasoline is stored.
- Do not overfill the tank. Do not fill the tank neck.
- If gasoline spills on your skin or clothing, immediately wash it off with soap and water and change clothing.

OPERATION

Break-In Period

The break-in period for your new Polaris Quadricycle is the first ten hours of operation, or the time it takes to use the first two full tanks of gasoline. No single action on your part will increase the life and performance of your Quadricycle more than following the procedures for a proper break-in. Careful treatment of a new engine and drive components will result in more efficient performance and longer life for these components.

Do not operate at full throttle or high speeds for extended periods during the first three hours of use.

Engine and Drivetrain Break-in

1. Fill the fuel tank with the recommended fuel. See page 28.
2. Check the engine oil level. See page 70. Add oil if necessary.
3. Select an open area that allows room to familiarize yourself with vehicle operation and handling.
4. Drive slowly. Vary the throttle positions. Do not operate at sustained idle.
5. Perform regular checks on fluid levels, controls and areas outlined on the daily pre-ride inspection checklist. See page 43.
6. Pull only light loads.
7. Change the oil and filter at one month.

PVT Break-in (Clutches/Belt)

Break in the clutches and belt by operating at slower speeds during the break-in period as recommended. Pull only light loads. Avoid aggressive acceleration and high speed operation during the break-in period.

Pre-Ride Checklist

Item	Remarks	Page
Hand brake/lever travel	Ensure proper operation	84
Foot brake	Ensure proper operation	84
Brake fluid	Ensure proper level	84
Passenger seat latch	Ensure latch is secure	29
Front suspension	Inspect, lubricate if necessary	69
Rear suspension	Inspect, lubricate if necessary	69
Steering/steering lock	Unlock the steering; ensure free operation	27
Steering	Ensure free operation	-
Tires	Inspect condition and pressure	89
Wheels/fasteners	Inspect, ensure fastener tightness	89 91
Frame nuts, bolts, fasteners	Inspect, ensure tightness	-
Fuel and oil	Ensure proper levels	28 70
Coolant level (if applicable)	Ensure proper level	80 81
Coolant hoses (if applicable)	Inspect for leaks	-
Throttle	Ensure proper operation	24 88
Indicator lights/switches	Ensure operation	20
Engine stop switch	Ensure proper operation	21
Mirrors	Adjust for best side/rear vision	24
Air filter, pre-filter	Inspect, clean	92
Air box sediment tube	Drain deposits whenever visible	-
Headlamp	Check operation, apply Polaris dielectric grease when lamp is replaced	95
Brake light/taillight	Check operation, apply Polaris dielectric grease when lamp is replaced	96
Riding gear	Wear approved helmet, goggles, and protective clothing	18
ADC Fluid	Ensure proper level	78

OPERATION

Starting the Engine

WARNING

Engine exhaust contains poisonous carbon monoxide and can cause loss of consciousness resulting in severe injury or death. Never run an engine in an enclosed area.



Operating the vehicle immediately after starting could cause engine damage. Allow the engine to warm up for several minutes before operating.

1. Position the vehicle on a level surface.
2. Place the transmission in PARK.
3. Sit on the vehicle.



NOTE: The starter interlock will prevent the engine from starting if the transmission is in gear and the brake is not engaged.

4. Move the engine stop switch to RUN.

NOTE: Do not press the throttle while starting the engine.

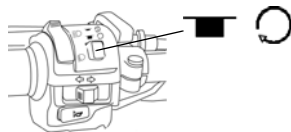

5. Turn the ignition key past the POSITION LIGHTS ON position to engage the starter. Activate the starter for a maximum of five seconds, releasing the key when the engine starts.

500 EFI ONLY: The starter will automatically stop if engaged for longer than 5 seconds. Move the key to the OFF position and wait 10 seconds before engaging the starter again.

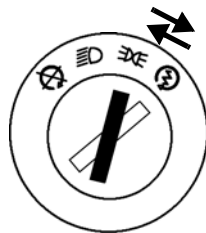

6. If the engine does not start, release the starter and wait five seconds.
7. Repeat steps 5 and 6 until the engine starts.

Cold Weather Operation

Internal engine condensation increases as outside temperatures decrease. If the vehicle is used year-round, check the oil level frequently. A rising oil level could indicate condensation in the bottom of the oil tank, which can lead to engine damage. Any condensation must be drained.

Always operate the engine long enough to reach operating temperature, which reduces condensation. See your Polaris dealer for engine heater kits, which provide quicker warm-ups and easier starting in cold weather.

PVT Operation

When To Use Low Range and High Range

Condition	Range to Use
Operating at speeds less than 11 km/h	Low
Towing heavy loads	Low
Operating in rough or rugged terrain	Low
Operating at speeds greater than 11 km/h	High

OPERATION

Driving Procedures



1. Wear protective riding gear. See page 18.
2. Perform the pre-ride inspection. See page 43.
3. Place the transmission in PARK.
4. Mount the vehicle from the left side.
5. Sit upright. Keep your feet on the footrests. Keep both hands on the handlebars.
6. Start the engine and allow it to warm up.
7. Apply the brakes.
8. Shift the transmission into gear.
9. Check your surroundings and determine your path of travel.
10. Release the brakes.
11. Slowly squeeze the throttle lever toward the handlebar to begin driving.
12. Drive slowly. Practice maneuvering and using the throttle and brakes on level surfaces.

Turning the Vehicle

1. Before turning, activate a turn signal to alert others of your intentions. Activate the left signal before a left turn. Activate the right signal before a right turn.
2. Steer in the direction of the turn, leaning your upper body to the inside of the turn while supporting your weight on the outer footrest. Use the same leaning technique for turning in reverse.
3. Never turn quickly when carrying a passenger or cargo.
4. Practice making turns at slow speeds before attempting to turn at faster speeds.



Always follow the procedures outlined in this manual for turning. Never turn sharply at excessive speeds, which can lead to vehicle overturn.

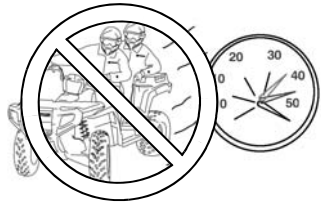

OPERATION

Driving with a Passenger



Never allow anyone under 16 years of age to operate this vehicle.

Never allow anyone under 12 years of age to ride as a passenger on this 2-up Quadricycle.

Never carry more than one passenger on this 2-up Quadricycle.



1. Make sure the passenger is at least 12 years of age and is tall enough to comfortably reach the footrests and grab handles.
2. Make sure the passenger is wearing appropriate riding gear, including an approved helmet with a rigid chin guard. See page 18.
3. Perform the pre-ride inspection. See page 43.
4. Always make sure the passenger seat is installed and securely latched before operating with a passenger.
5. Place the transmission in PARK.



Driving with a Passenger

6. Mount the vehicle from the left side.
7. After the operator is seated, the passenger should mount the vehicle from the left side.

NOTE: Allow a passenger to ride only in the approved passenger seat with both feet on the footrests and both hands on the passenger grab handles at all times. The passenger should never hold on to the operator.

8. Drive slowly. Control may be more difficult with a passenger on board. Allow more time and distance for braking.
9. Avoid unexpected or aggressive maneuvers that could cause a passenger to fall from the vehicle.
10. Do not cross a hillside with a passenger on board. See page 52.
11. Never secure a passenger to the vehicle or to the operator with a belt, rope or similar device.
12. Make sure the passenger understands the importance of "active riding." When hill-climbing or performing maneuvers, a passenger should shift body weight in the same manner in which the driver shifts body weight. For example, the passenger should lean to the inside of a turn along with the operator and should always lean uphill when climbing and descending hills.

OPERATION

Driving Uphill

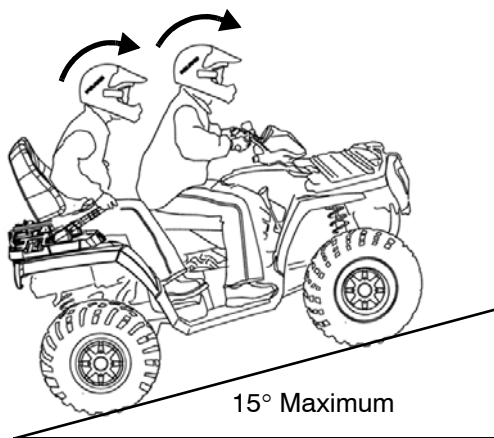

Whenever traveling uphill, follow these precautions:

1. Always move the 4X4 switch to ADC 4X4 before ascending or descending a hill. See page 31.
2. Avoid steep hills (15° maximum).
3. Avoid hills with slippery or loose surfaces.
4. Keep both feet on the footrests.
5. Shift body weight uphill.
6. Drive straight uphill.
7. Proceed at a steady rate of speed to avoid stalling.
8. Be alert. Be prepared to take emergency action. This may include dismounting quickly.
9. Never open the throttle suddenly or make sudden gear changes.
10. Never go over the top of a hill at high speed.

Driving Uphill

If all forward speed is lost:

Keep your weight uphill.

If the vehicle begins rolling downhill, never apply engine power. Never apply the brakes aggressively while rolling backwards.

1. Apply the brakes gradually.
2. When fully stopped, lock the hydraulic parking brake.
3. A passenger should dismount first. The operator should dismount last. Dismount on the uphill side, or on the left side if the vehicle is pointed straight uphill.
4. Use the K-turn to turn around. See page 54.

Always follow the procedures outlined in this manual for climbing hills. Avoid climbing hills steeper than 15°.



Always follow the procedures outlined in this manual for braking if you stall or roll backwards while climbing a hill. Never back down a hill.



OPERATION

Driving on a Sidehill (Sidehilling)

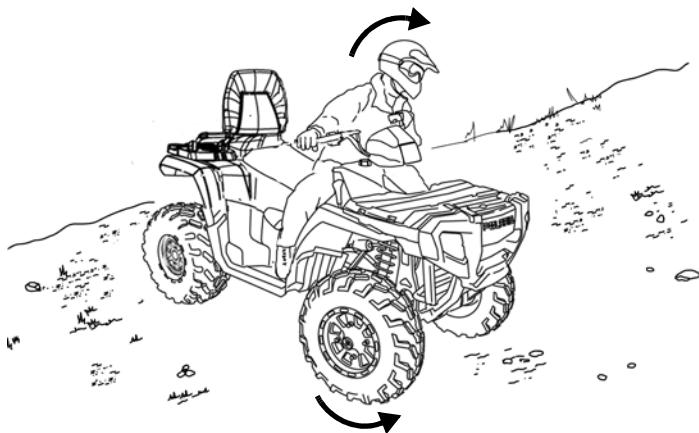

Avoid crossing the side of a hill (sidehilling) if possible. If sidehilling is necessary, follow these precautions:

1. Slow down.
2. If operating in 2X4 mode, make sure the differential is locked (🔒).
3. Avoid hills with slippery or loose surfaces.
4. Avoid crossing the sides of steep hills.
5. Do not cross a hillside with a passenger on board. Ask the passenger to dismount and walk across the hillside.
6. Shift your weight uphill.
7. Keep your feet on the footrests.
8. Steer slightly into the hill.

NOTE: If the vehicle begins to tip, quickly turn the front wheel downhill, if possible, or dismount on the uphill side *immediately!*



Always follow the procedures outlined in this manual for crossing the side of a hill.

Never attempt to turn the Quadricycle around on any hill until you've mastered (on level ground) the turning technique outlined in this manual.



Driving Downhill

When driving downhill, follow these precautions:

1. Always move the 4X4 switch to ADC 4X4 before ascending or descending a hill. See page 31.
2. Avoid hills with slippery or loose surfaces.
3. Never drive downhill at high speed. Slow down.
4. Drive straight downhill. Avoid driving downhill at an angle, which can cause the vehicle to pitch sharply to one side.
5. Shift your weight rearward.
6. Apply the brakes *slightly* to aid in slowing.

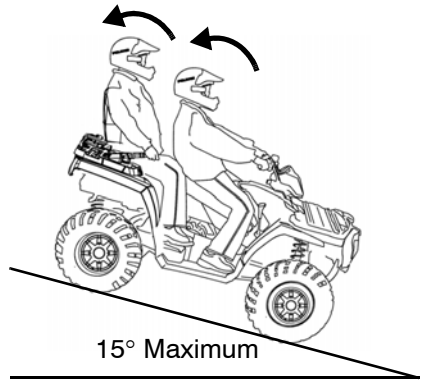

Always follow the procedures outlined in this manual for driving downhill and for braking on hills.

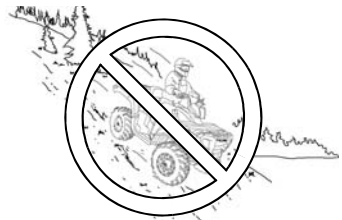

Never operate at excessive speeds. Travel and turn at speeds appropriate for the terrain, visibility, operating conditions and your experience.



OPERATION

Turning Around on a Hill (K-Turn)

If the vehicle stalls while climbing a hill, never back it down the hill!
Use the K-turn to turn around.

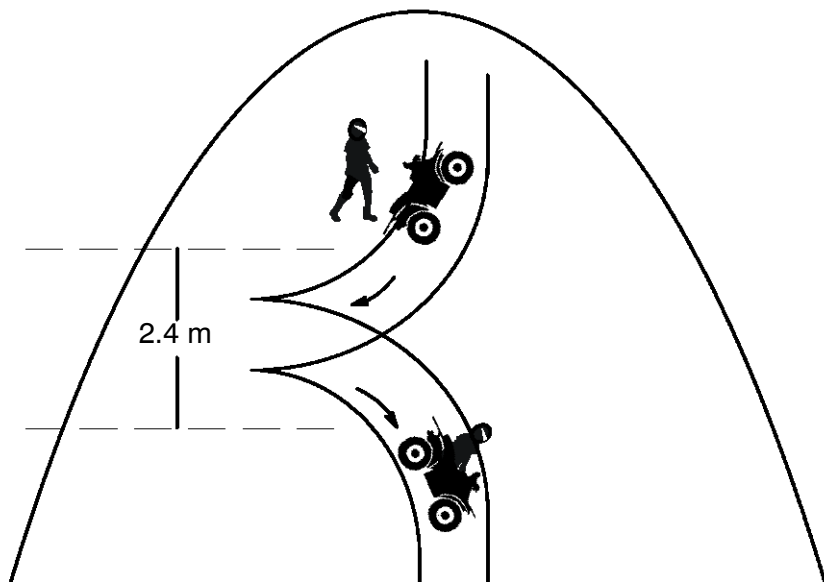

1. Stop the vehicle. Keep your weight uphill.
2. Always move the 4X4 switch to ADC 4X4 before ascending or descending a hill. See page 31.
3. Lock the hydraulic parking brake.
4. Leave the transmission in forward gear. Turn the engine off.
5. A passenger should dismount first. The operator should dismount last. Dismount on the uphill side, or on the left side if the vehicle is pointed straight uphill.
6. Stay uphill of the vehicle and turn the handlebars full left.
7. Squeeze the brake lever to release the parking brake.
8. Slowly release the brake lever and allow the vehicle to roll around to your right until it's pointing across the hill or slightly downward.

Turning Around on a Hill (K-Turn)

9. Lock the hydraulic parking brake.
 10. Remount from the uphill side. Keep your weight uphill.
- NOTE:** A passenger should not remount until the vehicle returns to level ground.
11. Apply the foot brake.
 12. With the transmission still in forward, start the engine.
 13. Squeeze and release the brake lever to release the parking brake.
 14. Release the foot brake and drive *slowly* downhill. Control speed with either the hand or foot brake until the vehicle is on level ground.

Always follow the procedures outlined in this manual for climbing hills. Avoid climbing hills steeper than 15° .

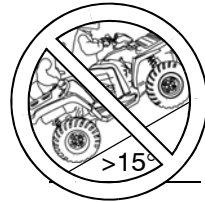

Always follow the procedures outlined in this manual for braking if you stall or roll backwards while climbing a hill. Never back down a hill.



OPERATION

Driving Through Water



Follow these procedures when driving through water:

1. Check water depth and current before crossing.
2. Choose a crossing where both banks have gradual inclines.
3. Drive slowly. Avoid rocks and obstacles.
4. Avoid operating in water deeper than the bottom of the footrests. If it's unavoidable, travel slowly, balance your weight carefully and avoid sudden movements. Maintain a slow and steady forward motion. Do not make sudden turns, stops or throttle changes.
5. Wet brakes may have reduced stopping ability. Dry the brake pads by driving slowly and applying the brakes lightly several times until braking action is normal.

Driving Through Water

If your vehicle becomes fully immersed, and it's impossible to take it to a dealer before starting it, follow the steps described on page 100. Have the vehicle serviced by your dealer promptly.



Always follow the procedures outlined in this manual for driving through water. Never drive through deep or fast-flowing water.



If the vehicle stops while fully submerged, major engine damage can result if the machine is not thoroughly inspected. Take the vehicle to your dealer before starting the engine.

OPERATION

Driving on Slippery Surfaces

Whenever driving on slippery or loose surfaces such as wet trails, gravel, snow or ice, follow these precautions:

1. Slow down before driving onto slippery surfaces.
2. Engage 4X4 before wheels begin to lose traction.
3. Be alert.
4. Watch the trail.
5. Avoid quick, sharp turns.
6. Correct a skid by turning the handlebars in the direction of the skid and shifting your body weight forward.
7. Never apply the brakes during a skid.

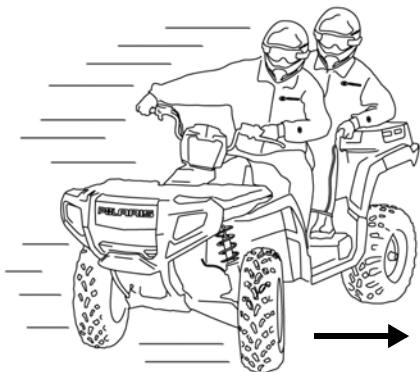

Always follow the procedures outlined in this manual for operating on slippery or loose surfaces. Use extra caution. Always avoid skidding or sliding.



Severe damage to drive train may occur if 4X4 is engaged while the wheels are spinning. Engage 4X4 when the wheels have traction.

Driving Over Obstacles

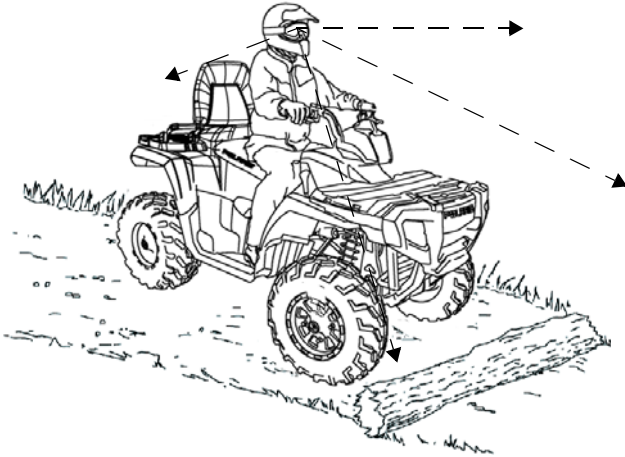

1. Always check for obstacles before operating in a new area.
2. Be alert. Watch the terrain. Use extra caution.
3. Never operate over large obstacles.
4. Avoid hazards such as logs, rocks and low branches.
5. Always have a passenger dismount before operating over an obstacle.



Always follow the procedures outlined in this manual for operating over obstacles.



OPERATION

Parking on an Incline

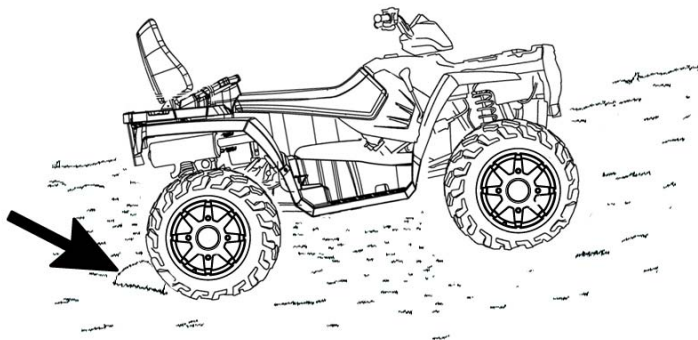

Avoid parking on an incline. If it's unavoidable, follow these precautions:

1. Stop the engine.
2. Place the transmission in PARK.
3. Always block the rear wheels on the downhill side.

Driving in Reverse

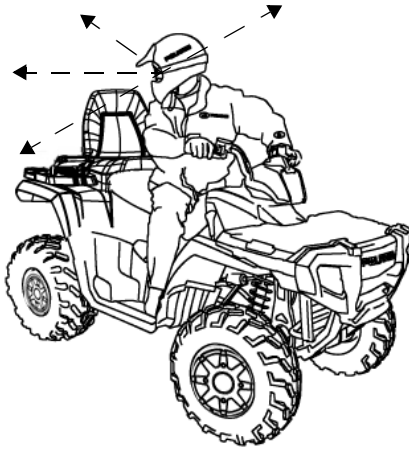

Follow these precautions when operating in reverse:

1. Always check for obstacles or people behind the vehicle before backing. Be aware that a passenger can obstruct your view.
2. Avoid backing downhill.
3. Drive slowly. Apply the brakes *lightly* for stopping.
4. Avoid turning at sharp angles.
5. Never open the throttle suddenly.
6. Do not use the override switch unless additional power is required for vehicle movement. Use with caution.



Excessive throttle operation while in the speed limit mode may cause fuel to build in the exhaust, resulting in engine popping and/or engine damage.



Always follow the procedures outlined in this manual for driving in reverse.



OPERATION

Hauling Cargo



Overloading the vehicle or carrying or towing cargo improperly can alter vehicle handling and may cause loss of control or brake instability. Always follow these precautions when hauling cargo.

- Read and understand the load distribution warnings listed on the vehicle warning labels.
- Never exceed the stated load capacity for this vehicle.
- Never carry cargo on the rear rack when operating the ATV in the 2-up mode with a passenger.
- **REDUCE SPEED AND ALLOW GREATER DISTANCES FOR BRAKING WHEN HAULING CARGO OR TOWING.** Use extreme caution when applying brakes. Avoid situations that require backing downhill.
- When operating over rough or hilly terrain, reduce speed, cargo and towed load to maintain stable driving conditions.
- **DO NOT BLOCK THE FRONT HEADLIGHT BEAM** when carrying loads on the front rack.
- **CARRY LOADS AS LOW ON THE RACK AS POSSIBLE.** Carrying a load high on the rack raises the center of gravity of the vehicle and creates a less stable operating condition. Reduce load weight when cargo is high. Secure off-centered loads that cannot be centered and operate with extra caution.
- **CARRYING A LOAD** on only one rack may cause the vehicle to overturn. Split the load between the front rack and rear rack, with 1/3 in the front and 2/3 in the back. Do not exceed load capacities. See specifications beginning on page 118.
- **SECURE ALL LOADS BEFORE OPERATING.** Unsecured loads can create unstable operating conditions, which could result in loss of control of the vehicle.
- **OPERATE ONLY WITH STABLE AND SAFELY ARRANGED LOADS.** When handling off-centered loads that cannot be centered, securely fasten the load and operate with extra caution. Always attach the tow load to the hitch point designated for your vehicle.
- **USE EXTREME CAUTION** when operating with loads that extend over the rack sides. Stability and maneuverability may be adversely affected, causing the vehicle to overturn.
- **TOWING is approved OFF-ROAD ONLY.** Operating a Quadricycle/trailer combination on public roads is prohibited.
- **TOWING SPEED** should never exceed 16 km/h. Never exceed 8 km/h when towing loads in rough terrain, while cornering, or while ascending or descending hills.

Hauling Cargo

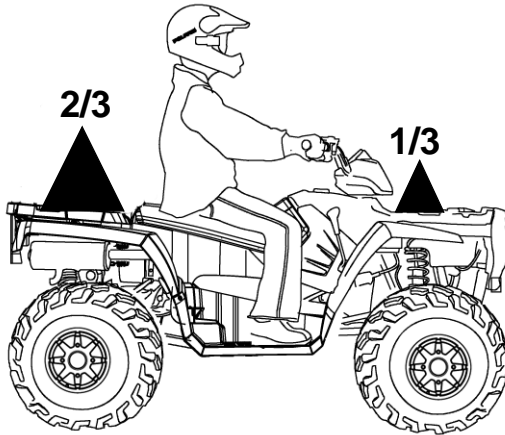

Towing Loads

Towing is approved OFF-ROAD ONLY. Operating a Quadricycle/trailer combination on public roads is prohibited. See your Polaris dealer about configuring the vehicle to be certified to tow a trailer on-road. Do not tow any trailer on a grade steeper than 15°.

Maximum Towing Capacities	
Maximum Towed Load (Level Ground)	680 kg
Maximum Vertical Hitch Weight	68 kg



Using an improper hitch or exceeding the maximum tongue weight capacity can result in serious damage to the vehicle and will void your warranty. Never install a hitch longer than 17 cm. Never install automotive accessories on your Polaris Quadricycle. Always install Polaris-approved (or equivalent) accessories designed for Quadricycle use.

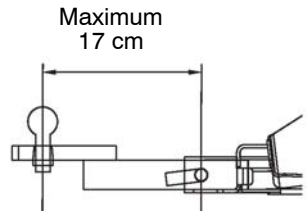

EMISSION CONTROL SYSTEMS

Noise Emission Control System

Do not modify the engine, intake or exhaust components, as doing so may affect compliance with governmental noise level requirements.

Spark Arrestor

Your Polaris vehicle has a spark arrestor that was designed for on-road and off-road operation. It is required that this spark arrestor remain installed and functional when the vehicle is operated.

Exhaust Emission Control System

Exhaust emissions are controlled by engine design. An electronic fuel injection (EFI) system controls fuel delivery. The engine and EFI components are set at the factory for optimal performance and are not adjustable.

Electromagnetic Interference

This spark ignition system complies with USA requirements, Canadian ICES-002 and European directives 89/336/EEC and 97/24/EC.

Periodic Maintenance Chart

Maintenance intervals in the following chart are based upon average riding conditions. Vehicles subjected to severe use must be inspected and serviced more frequently.

The programmable service interval mode on the instrument cluster will help determine when maintenance service is due. See page 32.

Record maintenance and service in the Maintenance Log beginning on page 128.

NOTE: Service and adjustments are important for proper vehicle operation. If you're not familiar with safe service and adjustment procedures, have a qualified dealer perform these operations.

Severe Use Definition

- Frequent immersion in mud, water or sand
- Racing or race-style high RPM use
- Prolonged low speed, heavy load operation
- Extended idle
- Short trip cold weather operation

Pay special attention to the oil level. A rise in oil level during cold weather can indicate contaminants collecting in the oil sump or crankcase. Change oil immediately if the oil level begins to rise. Monitor the oil level, and if it continues to rise, discontinue use and determine the cause or see your dealer.

MAINTENANCE

Periodic Maintenance Chart

Maintenance Chart Key

► Perform these operations more often for vehicles subjected to severe use.

E Emission-related service

■ Have an authorized Polaris dealer perform these services.

▲ WARNING

Improperly performing the procedures marked with a ■ could result in component failure and lead to serious injury or death. Have an authorized Polaris dealer perform these services.

Perform all services at whichever maintenance interval is reached first.

Item	Maintenance Interval (whichever comes first)			Remarks
	Hours	Calendar	Kilometers	
Steering	-	Pre-Ride	-	Make adjustments as needed. See Pre-Ride Checklist on page 43.
Front suspension	-	Pre-Ride	-	
Rear suspension	-	Pre-Ride	-	
Tires	-	Pre-Ride	-	
Brake fluid level	-	Pre-Ride	-	
Brake lever	-	Pre-Ride	-	
Foot brake	-	Pre-Ride	-	
Brake system	-	Pre-Ride	-	
Passenger seat latch	-	Pre-Ride	-	
Wheels/fasteners	-	Pre-Ride	-	
Frame fasteners	-	Pre-Ride	-	
► Engine oil level	-	Pre-Ride	-	
► E Air filter, pre-filter	-	Daily	-	
► Air box sediment tube	-	Daily	-	Drain deposits when visible
Coolant	-	Daily	-	Check level daily, change coolant every 2 years
► ADC fluid	-	Daily	-	Check level daily, add as needed
Headlight/taillight	-	Daily	-	Check operation; apply dielectric grease if replacing lamps

MAINTENANCE

Periodic Maintenance Chart

Item		Maintenance Interval (whichever comes first)			Remarks
		Hours	Calendar	Kilometers	
▶ E	Air filter, main element	-	Weekly	-	Inspect; replace as needed
▶ ■	Brake pad wear	10	Monthly	160	Inspect periodically
	Battery	20	Monthly	320	Check terminals; clean; test
▶	Demand drive fluid	25	Monthly	400	Inspect level; change yearly
▶	Rear gearcase oil (if equipped)	25	Monthly	400	Inspect level; change yearly
▶	Transmission oil	25	Monthly	400	Inspect level; change yearly
▶ E	Engine breather filter (if equipped)	25	Monthly	400	Inspect; clean if needed
▶	Engine oil change (break-in)	-	1 M	-	Perform a break-in oil change at one month
▶	General lubrication	50	3 M	800	Lubricate all fittings, pivots, cables, etc.
	Shift linkage	50	6 M	800	Inspect, lubricate, adjust
■	Steering	50	6 M	800	Lubricate
▶	Front suspension	50	6 M	800	Lubricate
▶	Rear suspension	50	6 M	800	Lubricate
■ E	Throttle cable/ ETC switch	50	6 M	800	Inspect; adjust; lubricate; replace if necessary
E	Throttle body intake duct	50	6 M	800	Inspect duct for proper seal- ing/air leaks
	Drive belt	50	6 M	800	Inspect; adjust; replace as needed
	Cooling system	50	6 M	1600	Inspect coolant strength seasonally; pressure test system yearly
▶	Engine oil change	100	6 M	1600	Perform a break-in oil change at one month
▶	Oil filter change	100	6 M	1600	Replace with oil change
▶	Oil tank vent hose (if equipped)	100	6 M	1600	Inspect routing, condition

MAINTENANCE

Periodic Maintenance Chart

Item		Maintenance Interval (whichever comes first)			Remarks
		Hours	Calendar	Kilometers	
■ E	Valve clearance	100	12 M	1600	Inspect; adjust
■ E	Fuel system	100	12 M	1600	Check for leaks at tank cap, lines, filter, pump; replace lines every 2 years
▶	Radiator	100	12 M	1600	Inspect; clean external surfaces
▶	Cooling hoses	100	12 M	1600	Inspect for leaks
▶	Engine mounts	100	12 M	1600	Inspect
	Exhaust muffler/pipe	100	12 M	1600	Inspect
■ E	Spark plug	100	12 M	1600	Inspect; replace as needed
▶	Wiring	100	12 M	1600	Inspect for wear, routing, security; apply dielectric grease to connectors subjected to water, mud, etc.
■	Clutches (drive and driven)	100	12 M	1600	Inspect; clean; replace worn parts
■	Front wheel bearings	100	12 M	1600	Inspect; replace as needed
■	Brake fluid	200	24 M	3200	Change every two years
■	ADC fluid	200 H	24 M	2000 (3200)	Change every two years
▶ ■ E	Fuel filter	200	24 M	3200	Replace every 2 years, more often under severe use
	Spark arrestor	300	36 M	4800	Clean out
■	Toe adjustment	-			Inspect periodically; adjust when parts are replaced
	Headlight aim	-			Adjust as needed

▶ Perform these procedures more often for vehicles subjected to severe use.

E Emission-Related Service

■ Have an authorized Polaris dealer perform these services.

MAINTENANCE

Lubrication Guide

Check and lubricate all components at the intervals outlined in the Periodic Maintenance Chart beginning on page 65. Items not listed in the chart should be lubricated at the General Lubrication interval.

NOTE: The a-arms and upper control arms are lubricated at the factory, and no additional lubrication will be needed. However, if these components are subjected to severe use, grease zerks have been provided for additional lubrication at the user's discretion.

Item	Lube	Capacity at Fluid Change	Method
Engine Oil	PS-4 PLUS Performance Synthetic 2W-50	2 qt. (1.9 l)	See page 70.
Brake Fluid	DOT 4 Only	---	See page 82.
Transmission Oil	Polaris AGL Synthetic Gearcase Lube	32 oz. (948 ml)	See page 74.
Demand Drive Fluid (Front Gearcase)	Demand Drive LT Premium Fluid	9.3 oz. (275 ml)	See page 76.
ADC Fluid	Polaris ADC Fluid	---	See page 78.
Front Prop Shaft Yoke	Polaris Premium U-Joint Lube	---	Grease fittings (3 pumps maximum) every 800 km, before long periods of storage, or after pressure washing or submerging.

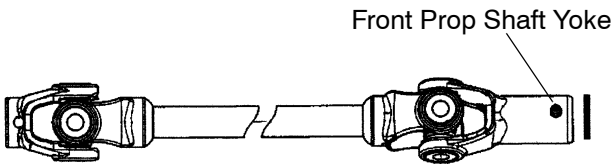

MAINTENANCE

Engine Oil

Oil Recommendations

Always change the oil filter whenever changing oil.

Polaris recommends the use of Polaris PS-4 *PLUS Performance* Synthetic 2W-50 4-cycle oil or a similar oil for this engine. Oil may need to be changed more frequently if Polaris oil is not used. Always use 2W-50 oil. Follow the manufacturer's recommendations for ambient temperature operation



Mixing brands or using a non-recommended oil may cause serious engine damage. Always use a recommended oil. Never substitute or mix oil brands.

Oil Specifications

Lubricant	Capacity	Drain Plug Torque
PS-4 PLUS Performance Synthetic 2W-50 4-Cycle Oil	1.9 liters	27 N-m

Engine Oil Oil Level

1. Position the vehicle on a level surface.
2. Place the transmission in PARK.



-
3. Lift the lever lock.
Remove the dipstick.
Wipe it dry with a clean cloth.
 4. Reinstall the dipstick completely, but do not lock it.

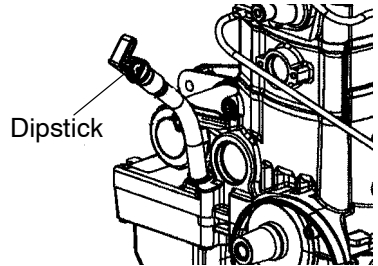

-
5. Remove the dipstick and check the oil level on the top side of the dipstick.
 6. Maintain the oil level in the safe range. Do not overfill.

Check Level
on Top Side



NOTE: The oil level will read higher on the bottom side of the dipstick. Always read the level on the upper surface of the dipstick.

7. Reinstall the dipstick.
8. Secure the lever lock.

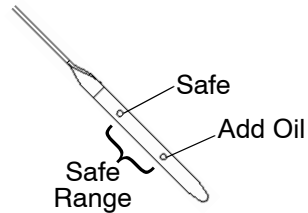

MAINTENANCE

Engine Oil

Oil and Filter Change

⚠ CAUTION

Hot oil may result in serious burns. Do not allow hot oil to contact skin.

1. Position the vehicle on a level surface.
2. Place the transmission in PARK.



3. Start the engine. Allow it to idle for 2-3 minutes.
4. Stop the engine.

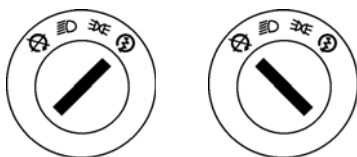

5. Clean the area around the drain plug.

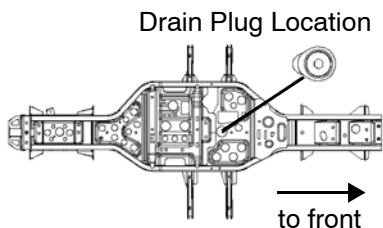

6. Remove the drain plug. Drain the oil into a drain pan.
7. Clean the drain plug. Reinstall the drain plug with a new sealing washer.
8. Torque to specification. See page 70.

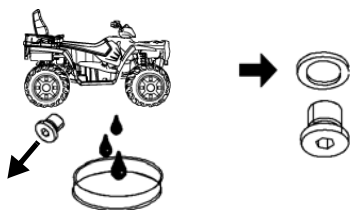

Engine Oil Oil and Filter Change

- Place towels under the oil filter.
Using an oil filter wrench, turn the filter counterclockwise to remove it.
- Clean the filter sealing area on the crankcase.

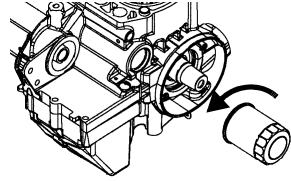

- Lubricate the filter o-ring. Check to make sure the o-ring is in good condition.
- Install the new oil filter. After the filter contacts the crankcase surface, turn it 1/2 turn by hand.



- Remove the dipstick.
- Add 1.9 liters of recommended oil.

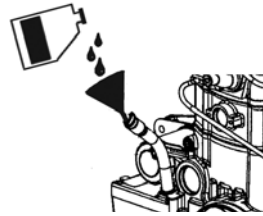

- Place the transmission in PARK.
- Start the engine. Allow it to idle for 1-2 minutes.
- Stop the engine.

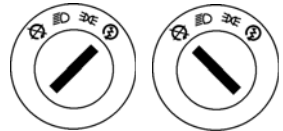
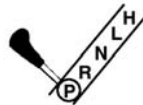

- Check for leaks.
- Check the oil level. Add oil as needed. Maintain the oil level in the safe range. Do not overfill.
- Discard used oil and filter properly.

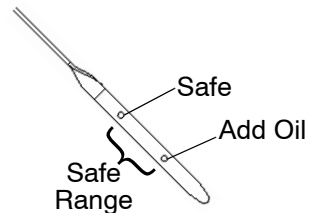

MAINTENANCE

Transmission Oil

Maintain the oil level at the bottom of the fill plug hole threads. Use the recommended oil.

See page 120 for the part numbers of Polaris products.

Transmission Oil Recommendations

Lubricant	Oil Change Capacity	Fill Plug Torque	Drain Plug Torque
Premium AGL Synthetic Gearcase Lubricant	948 ml	30 N-m	30 N-m

Transmission Oil Level

1. Position the vehicle on a level surface.
2. Place the transmission in PARK.

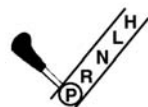

3. Remove the fill plug.
4. Check the oil level. Add the recommended oil as needed. Do not overfill.
5. Reinstall the fill plug. Torque to specification.

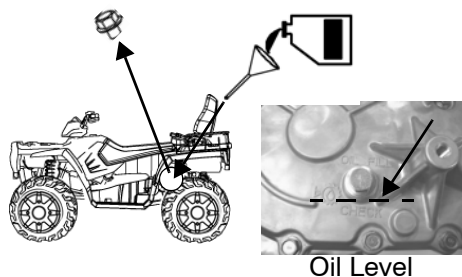

Transmission Oil Transmission Oil Change

1. Position the vehicle on a level surface.
2. Place the transmission in PARK.



3. Remove the fill plug.
4. Remove the drain plug.
5. Drain the oil into a drain pan.
6. Clean the drain plug.
7. Reinstall the drain plug. Torque to specification. See page 74.

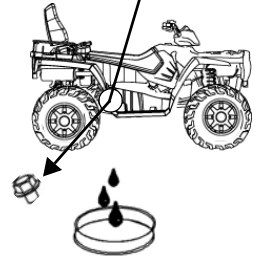
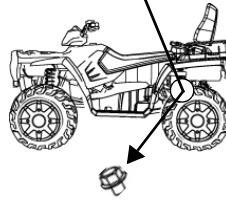
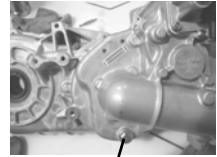

8. Add the recommended oil. See page 74.
9. Reinstall the fill plug. Torque to specification. See page 74.
10. Check for leaks.
11. Discard used oil properly.

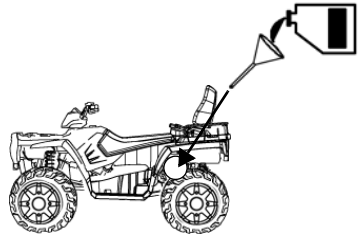

MAINTENANCE

Front Gearcase (Demand Drive) Fluid Fluid Recommendations

Gearcase	Lubricant	Capacity	Fill Plug Torque	Drain Plug Torque
Demand Drive Unit	Demand Drive LT Premium Fluid	275 ml	11-14 N-m	15 N-m

Use the recommended fluid. Use of other fluids may result in improper operation of components. See page 120 for the part numbers of Polaris products.

Maintain the fluid level at the bottom of the fill hole threads.

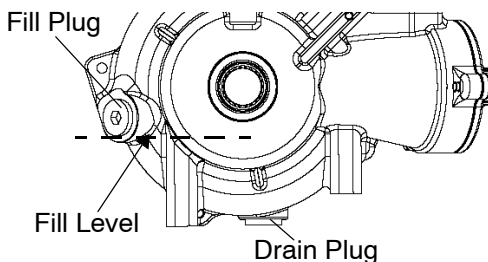

Fluid Level

1. Position the vehicle on a level surface.
2. Place the transmission in PARK.

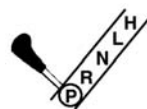

-
3. Remove the fill plug. Check the fluid level.
 4. Add the recommended demand drive fluid as needed.
 5. Reinstall the fill plug. Torque to specification.
-

MAINTENANCE

Front Gearcase (Demand Drive) Fluid Fluid Change

1. Position the vehicle on a level surface.
2. Place the transmission in PARK.

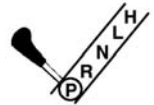
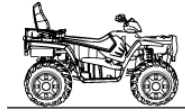

-
3. Remove the fill plug.
 4. Remove the drain plug.
Drain the fluid into a drain pan.

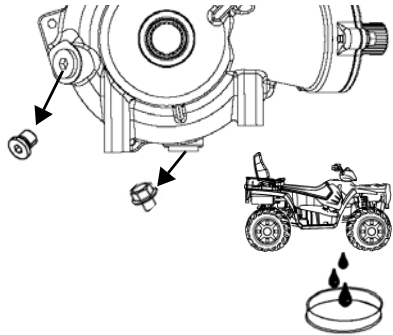

-
5. Clean the drain plug.
 6. Reinstall the drain plug. Torque to specification. See page 76.
 7. Add the recommended fluid.
 8. Reinstall the fill plug. Torque to specification.
 9. Check for leaks.
 10. Discard used oil properly.

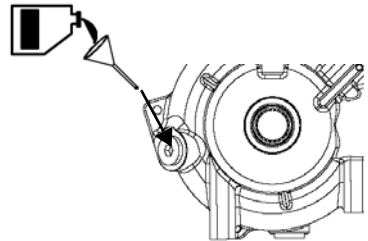

MAINTENANCE

Active Descent Control (ADC) Fluid

The ADC fluid reservoir is located under the front box. The reservoir cap is yellow. We recommend the use of Polaris ADC Fluid. See page 120 for the part numbers of Polaris products.

Fluid Level

1. Position the vehicle on a level surface.
2. Open the front box cover.
3. Open the access door.
4. View the fluid level in the reservoir.
5. Remove the cap and add the recommended fluid as needed.

NOTE: DO NOT use brake fluid.

6. Maintain the fluid level between the minimum and maximum marks. Do not over-fill.

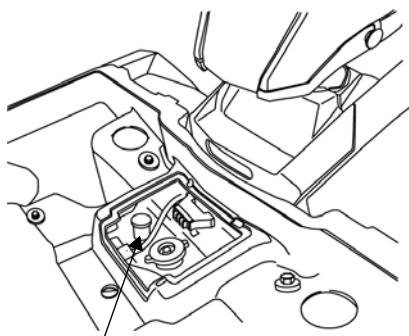
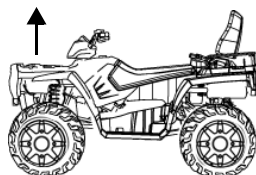

ADC Fluid Reservoir

Active Descent Control (ADC) Fluid

Fluid Change

1. Position the vehicle on a level surface. Before performing the fluid change, allow the vehicle to sit for at least 30 minutes.
2. Thoroughly clean the areas around and on the ADC reservoir and bleeder valves (one on each side of the differential).
3. Remove the reservoir cap and diaphragm assembly. Use a shop towel or suction tool to remove debris from the fluid and reservoir.

NOTE: Debris in the reservoir may result in inadequate bleeding and reduced performance of the system.

4. Fill the reservoir to the maximum line with fresh ADC fluid.
5. Remove the protective caps from the bleeder valves.
6. Slowly loosen one of the valves (turn counter-clockwise) and allow fluid and trapped air to flow from the fitting. Close the valve when clean fluid begins to flow. Repeat this step for the remaining valve.

IMPORTANT: Close the bleeder valves before the reservoir fluid level drops below the minimum fill line. Adding fluid to an empty reservoir will result in trapped air. If the level drops below the minimum line, add fluid to the maximum line and repeat step 6 before proceeding.

7. Torque the valves to 9 N-m. Reinstall the valve caps.
8. Add fresh ADC fluid to the reservoir until the level is between the minimum and maximum marks. Make sure the reservoir is free of debris.
9. Reinstall the cap securely. Clean up any drips or spills.

MAINTENANCE

Cooling System

Any time the cooling system has been drained for maintenance or repair, replace the coolant with a fresh mixture of antifreeze and water. Drain the cooling system every two years. Add fresh coolant.

Polaris recommends the use of Polaris Premium 60/40 anti-freeze/coolant or a 50/50 mixture of high quality aluminum compatible anti-freeze/coolant and distilled water. Polaris Premium 60/40 is premixed and ready to use. Do not dilute with water. See page 120 for the part numbers of Polaris products.

NOTE: Always follow the manufacturer's mixing recommendations for the freeze protection required in your area.

Recovery Bottle Coolant

Some coolant level drop on new machines is normal, as the system is purging itself of trapped air. Add coolant as needed.

NOTE: Check the coolant level in the radiator any time the recovery bottle has run dry. Add coolant as needed.



1. Check the coolant level when the fluid is cool.
2. Remove the left side panel. See page 87.

NOTE: Maintain the coolant level between the minimum and maximum marks on the bottle (when the fluid is cool).

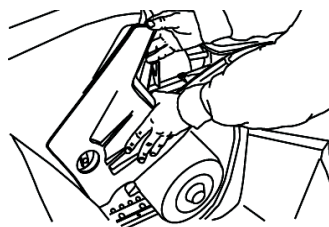

3. View the coolant level.
4. Add coolant as needed.
5. Reinstall the side panel.

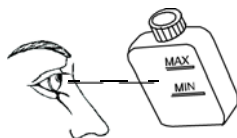

Cooling System Radiator Coolant

WARNING

Escaping steam can cause severe burns. Never remove the pressure cap while the engine is warm or hot.

1. Open the front box cover.
2. Open the access door.

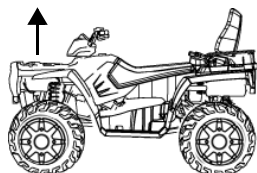

3. Remove the radiator pressure cap.
4. If coolant is not visible, slowly add coolant through the radiator filler neck.
5. Reinstall the pressure cap.
6. Secure the access door and box cover.

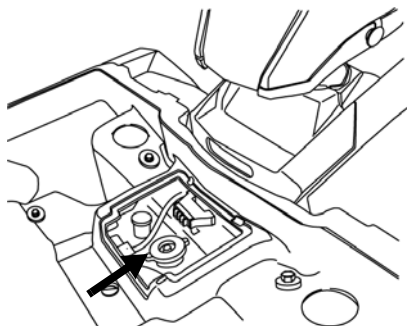

NOTE: Use of a non-standard pressure cap will not allow the recovery system to function properly. Contact your dealer for the correct replacement part.

MAINTENANCE

Brake Fluid

Check brake fluid levels for both brake systems before each ride. Always maintain brake fluid at the recommended level. Do not overfill.

The brakes should feel firm when they're applied. Spongy or weak brakes may indicate a fluid leak or low fluid level. A low fluid level may also mean that brake pads are worn and need to be replaced. Do not operate the vehicle with spongy or weak brakes. See your dealer for service.

▲ WARNING

Operating the Quadricycle with a spongy brake can result in loss of braking, which could cause an accident. Never operate the Quadricycle with spongy-feeling brakes.

If the fluid level is low add DOT 4 brake fluid only. See page 120 for the part numbers of Polaris products.

▲ WARNING

An over-full master cylinder may cause brake drag or brake lock-up, which could result in serious injury or death. Maintain brake fluid at the recommended level. Do not overfill.

Under normal operation, the diaphragm extends into the reservoir as fluid level drops. If the fluid level is low and the diaphragm is not extended, a leak is likely and the diaphragm should be replaced. To ensure proper diaphragm operation, always fill the reservoir as needed whenever the cover is loosened or removed. Do not overfill.

▲ WARNING

Never store or use a partial bottle of brake fluid. Brake fluid is hygroscopic, meaning it rapidly absorbs moisture from the air. The moisture causes the boiling temperature of the brake fluid to drop, which can lead to early brake fade and the possibility of accident or severe injury. After opening a bottle of brake fluid, always discard any unused portion.

Brake Fluid

Hand Brake

The master cylinder is located on the left handlebar. Maintain the fluid level 6 mm below the top edge of the master cylinder. Do not overfill.

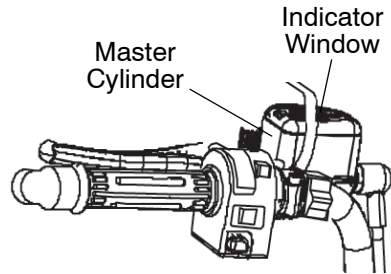

1. Position the vehicle on a level surface. Make sure the handlebars are straight.
2. View the fluid level through the indicator window (eye) on the top of the master cylinder.

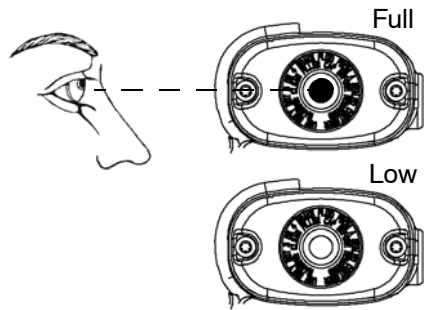

NOTE: The eye will appear dark when the fluid level is full. When fluid is low, the eye will be clear.

3. Add the recommended fluid as needed. Do not overfill.

Foot Brake

Check the brake fluid level frequently for the foot brake system. The reservoir is located under the seat. Maintain the fluid level between the maximum and minimum marks.

MAINTENANCE

Brakes

The front and rear brakes are hydraulic disc brakes, activated by applying the foot brake. The handlebar brake is also hydraulic. Both brake systems are self-adjusting.

Brake Inspections

Perform the following checks to keep the brake systems in good operating condition. Check more often if brakes are used heavily under normal operation.

1. Always keep brake fluid at an adequate level. See page 82.
2. Check the brake systems regularly for fluid leaks.
3. Check the brakes for excessive travel or spongy feel.
4. Check the friction pads for wear, damage and looseness. Replace the pads when the friction material is worn to 1 mm.
5. Check the security and surface condition of the disc.

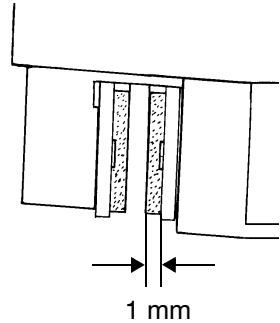

Toe Alignment

⚠ WARNING

Do not attempt to adjust alignment. All steering adjustments should be performed by an authorized Polaris dealer.

Use the following procedure to check the toe alignment of the vehicle. The recommended toe alignment is 3-6 mm toe out.

1. Position the vehicle on a level surface.
2. Place the handlebars in a straight-ahead position.
3. Tie a length of string between two stands as shown in the illustration. Position the stands so that the string is flush with the side of the rear tire.

NOTE: If available, you may use a long straight-edge instead of string.

4. Measure the distance from the string to the rim at the front (1) and rear (2) of the front rim.

The rear measurement should be 2-3 mm more than the front measurement on each side of the vehicle to obtain the recommended 3-6 mm toe out alignment.

5. Repeat the measurement procedure on the other side of the vehicle.

NOTE: If you discover improper alignment, see your Polaris dealer for service.

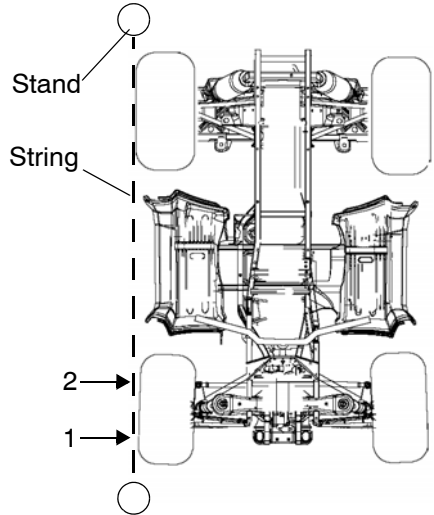

MAINTENANCE

Handlebar Adjustment

The handlebars can be adjusted for rider preference.

▲ WARNING

Improper adjustment of the handlebars or incorrect torquing of the adjuster block tightening bolts can cause limited steering or loosening of the handlebars, resulting in loss of control. Follow the adjustment procedures exactly, or see your Polaris dealer for service.

1. Remove the upper headlight pod.
2. Loosen the four handlebar bolts.
3. Adjust the handlebar to the desired height.

NOTE: Be sure the handlebars do not contact the gas tank or any other part of the machine when turned fully to the left or right.

4. Torque the front two bolts to 14-17 N-m, then torque the rear two bolts. A gap of up to 3 mm will remain at the rear of the clamp blocks.

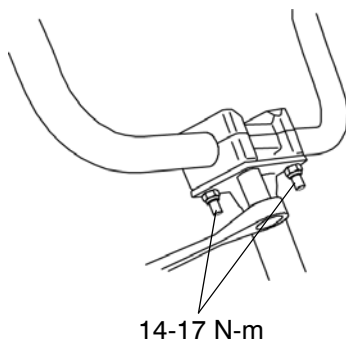

Steering Assembly

Check the steering assembly of the vehicle periodically for loose nuts and bolts. If loose nuts and bolts are found, see your Polaris dealer for service before operating the vehicle.

Rear Spring

The rear shock absorber spring is adjusted by rotating the adjuster either clockwise or counterclockwise to increase or decrease spring tension.

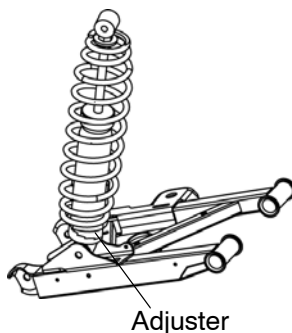

Side Panel Removal

1. Remove the seat.

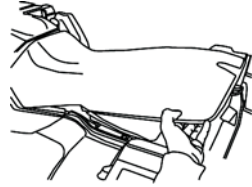

2. Grasp the rear of the side panel near the rear cab.
3. With a firm motion, pull the panel outward to disengage the side panel from the grommet.
4. Pull the panel downward and rearward to remove it.

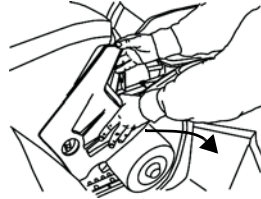

5. When reinstalling side panels, align the fasteners and press firmly to secure them.

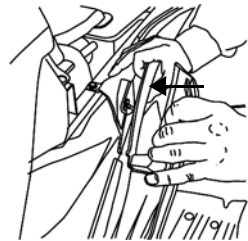

Footwell Removal

1. Remove the six screws on the bottom of the footwell.
2. Use a flat screwdriver or sidecutters to remove the plastic rivets securing the footwell to the fenders.
3. Remove the footwell.

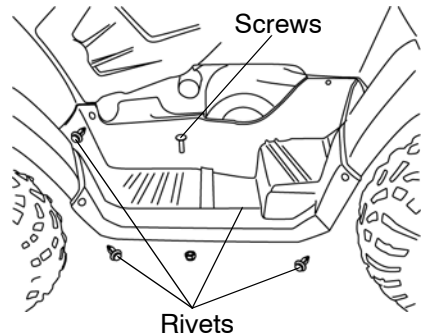

MAINTENANCE

Throttle Cable Freeplay

Adjust throttle cable freeplay at the handlebar.

1. Locate the throttle cable adjuster at the handlebar.

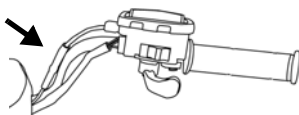

2. Squeeze the end of the rubber boot and slide it far enough to expose the end of the inline cable adjuster.

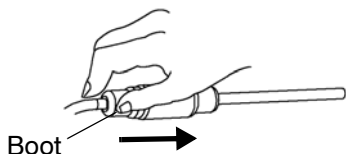

3. Loosen the adjuster lock nut.

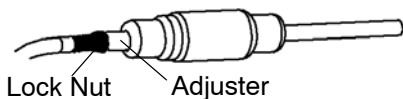

4. Rotate the boot to turn the adjuster until 1.6-3.2 mm of freeplay is achieved at the thumb lever.

NOTE: Move the throttle lever back and forth while adjusting.

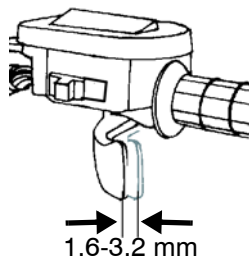

5. Tighten the lock nut.
6. Squeeze the end of the rubber boot and slide it over the cable adjuster to its original position.

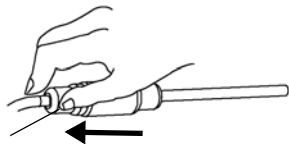

NOTE: Engine RPM should not increase when steering is turned full left or right. Readjust cable freeplay if this occurs.

Tires

Refer to the specifications section beginning on page 118 for recommended tire type, size and pressure.

▲ WARNING

Operating your vehicle with worn tires, improperly inflated tires, non-standard tires or improperly installed tires will affect vehicle handling and could cause an accident.

- Maintain proper tire pressure as described on the decal on your vehicle and in the specifications section of the owner's manual.
- Use only original equipment size and type when replacing tires.
- Make sure the wheels are installed properly.
- Replace tires when the tread depth measures 3 mm or less.

Tire Tread Depth

Always replace tires when tread depth is worn to 3 mm or less.

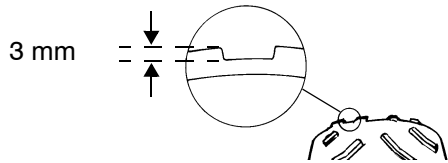

Front Wheel Hub Tightening

Front wheel bearing tightness and spindle nut retention are critical component operations. All service must be performed by your authorized Polaris dealer.

MAINTENANCE

Tires

Wheel Nut Torque Specifications

Check the wheel nut torques occasionally and when they've been loosened for maintenance service.

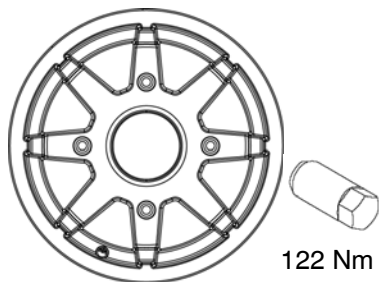

Cast Aluminum

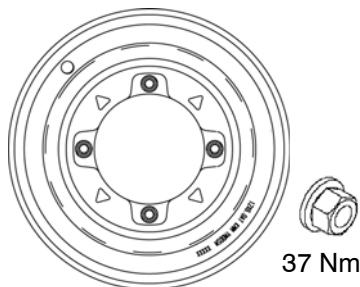

Steel

Nut Type	Nut Torque
Lug Nut	122 Nm
2-Piece Flange Nut	37 Nm

Tires



Always use original equipment size and type when replacing tires. Install wheels properly.

Wheel Removal/Installation

1. Position the vehicle on a level surface.
2. Place the transmission in PARK.

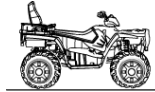

3. Loosen the wheel nuts slightly.
4. Place a suitable stand under the footrest frame to raise the wheel slightly off the ground.
5. Remove the wheel nuts.
6. Remove the wheel.

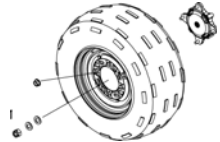

7. Place the wheel on the hub.
8. Install the wheel nuts finger tight.
9. Lower the vehicle to the ground.
10. Torque the wheel nuts to specification. See torque chart on page 90.

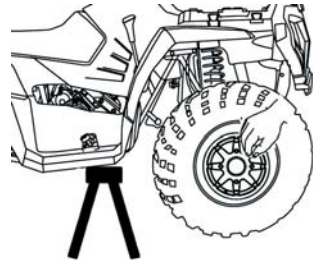

MAINTENANCE

Air Filter

Always clean and replace the air and breather filters at the intervals outlined in the Periodic Maintenance Chart beginning on page 65.

1. Position the vehicle on a level surface.
2. Place the transmission in PARK.

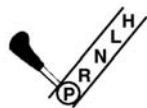

-
3. Remove the seat.
 4. Release the air box cover clips.
 5. Remove the air box cover.

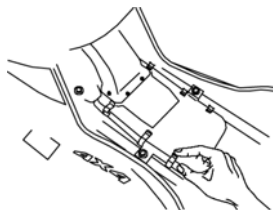
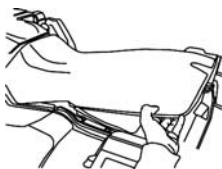

-
6. Loosen the hose clamp.
 7. Remove the filter.
 8. Remove the pre-filter from the filter.

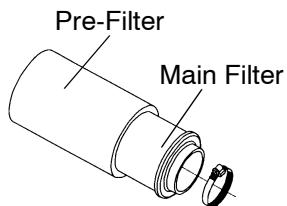

-
9. Wash the pre-filter in soapy water. Rinse and air dry.

NOTE: Replace the filter if needed.

10. Reverse the steps to reinstall all components.
-

Breather Filter/Hose

The breather filter is on the hose between the engine and air box.

1. Remove the left side panel.
See page 87.

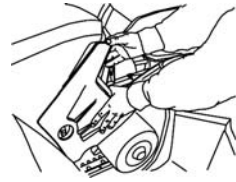

-
2. Remove the hose clamps from the filter and pull the filter out of the hoses.
 3. Inspect the filter for debris. Blow gently through the filter in the direction of the arrow to check for clogging. Replace a damaged or clogged filter.

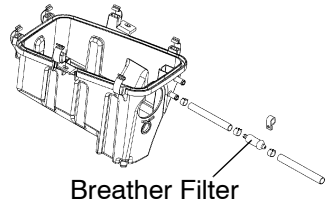

-
4. Check the hoses for cracks, deterioration, abrasion, or leaks.
Replace as needed.
 5. Reinstall the filter and hose clamps.

NOTE: The filter is effective with the arrow pointing in either direction.



Operation of your vehicle without a breather filter can cause engine damage.

MAINTENANCE

Lights

High Beam Adjustment

The headlight beam can be adjusted slightly upward or downward.

1. Position the vehicle on a level surface. The headlight should be approximately 7.6 m from a wall.
2. Place the transmission in PARK.

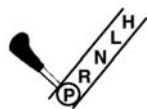

3. Measure the distance from the floor to the center of the headlight and make a mark on the wall at the same height.

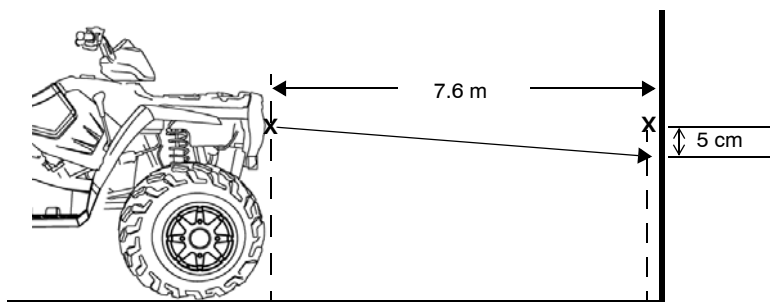

NOTE: Include rider weight on the seat when measuring.

4. Start the engine. Turn the headlight switch to high beam.
5. Observe the headlight aim on the wall. The most intense part of the headlight beam should be 5 cm below the mark on the wall.
6. Tighten or loosen the lower headlight screws to adjust the beam upward or downward or to the left or right.

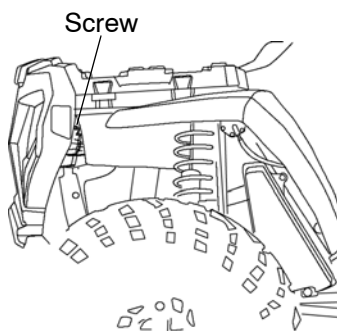

Lights

▲ WARNING

Poor lighting can result in loss of control or an accident. Lights become dirty during normal operation. Wash the headlights and taillights frequently.

Hot components can cause serious burns to skin. Do not service the headlamps until they've cooled.

Headlight/Position Light Lamp Replacement

When servicing a halogen lamp, do not touch the lamp with bare fingers. Oil from your skin leaves a residue, causing a hot spot that will shorten the life of the lamp. Hold the plastic part of the lamp.

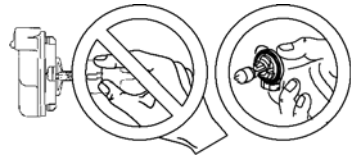

1. Place the transmission in PARK.
2. Open the front rack cover.
3. Remove the plug at the back of the headlight.
4. Pull the harness plug to disconnect it from the back of the headlight.
5. *Position light*: Rotate the socket to remove it. Go to step 6.
Headlamp: Reach under the bumper and remove the rubber cover from the back of the headlight. Turn the collar counter-clockwise and carefully remove the collar and socket.
6. Remove the lamp. Apply dielectric grease to the socket and install a new lamp.
7. Reverse all steps to reassemble the headlight.

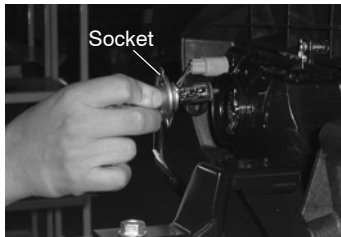
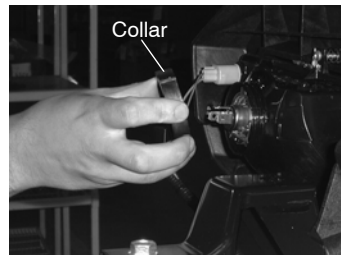
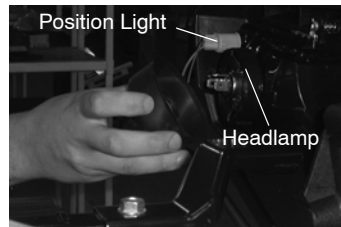

MAINTENANCE

Lights

Taillight Lamp Replacement

1. Place the transmission in PARK.
2. Rotate the taillight socket counterclockwise to remove it.
3. Remove the lamp.
4. Apply dielectric grease to the socket.
5. Install the new lamp. Test the lamp for proper operation.
6. Reinstall all components in reverse order.

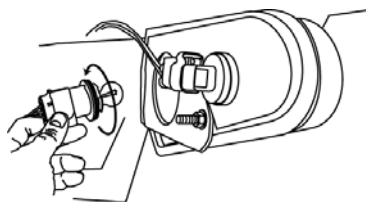

Front Turn Signal Lamp Replacement

1. Place the transmission in PARK.
2. Remove the lens attachment screw.
3. Rotate the lamp to remove it.
4. Install the new lamp.
5. Reinstall the lens.

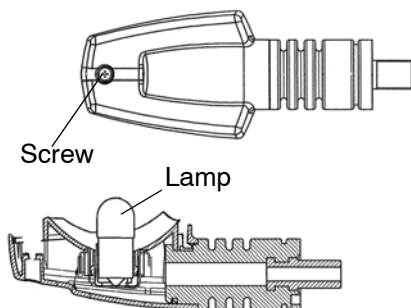

Rear Turn Signal Lamp Replacement

1. Place the transmission in PARK.
2. Rotate the turn signal socket counterclockwise to remove it.
3. Remove the lamp.
4. Apply dielectric grease to the socket.
5. Install the new lamp. Test the lamp for proper operation.
6. Reinstall all components in reverse order.

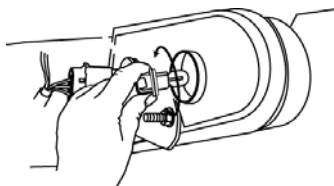

Fuse Replacement

If the engine stops or will not start, or if you experience other electrical failures, a fuse may need replacement.

NOTE: Spare fuses are provided in a compartment on the top of the access door.

1. Open the front box cover.
2. Open the access door.
3. Remove the suspect fuse from the fuse panel. Install a new fuse with the same amperage.
4. Secure the access door.
5. Secure the box cover.

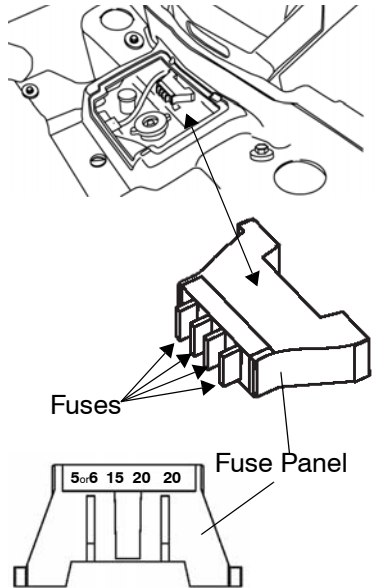

MAINTENANCE

Spark Plugs

Spark Plug Recommendations

Refer to the specifications section beginning on page 118 for the recommended spark plug type and gap for your vehicle. Torque spark plugs to specification.

Plug Condition	Torque Specification
New Spark Plug	12-15 N-m
Previously Installed Spark Plug	23-27 N-m

Spark Plug Inspection

Spark plug condition is indicative of engine operation. Check the spark plug firing end condition after the engine has been warmed up and the vehicle has been driven at higher speeds. Immediately check the spark plug for correct color.

Normal Spark Plug

The normal insulator tip is tan or brown. There will be few combustion deposits. The electrodes are not burned or eroded. This indicates the proper type and heat range for the engine and the service.

NOTE: The tip should not be white. A white insulator tip indicates overheating, caused by use of an improper spark plug or incorrect throttle body adjustments.

Wet Fouled Spark Plug

The wet fouled insulator tip is black. A damp oil film covers the firing end. There may be a carbon layer over the entire nose. Generally, the electrodes are not worn. General causes of fouling are excessive oil consumption, use of non-recommended oil or incorrect throttle body adjustments.

Spark Plugs Spark Plug Removal



A hot exhaust system and engine can cause serious burns. Wear protective gloves when removing a spark plug for inspection.

1. Remove the spark plug cap.
2. Use the spark plug wrench to remove the spark plug. Turn the plug counterclockwise to remove it.

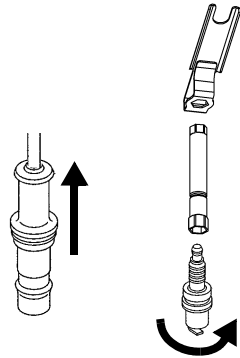

3. Inspect the electrodes for wear and carbon buildup. Replace worn or fouled plugs. Verify that the gap is at specification before installation.

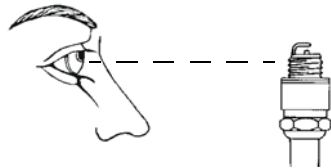

4. Reinstall the spark plug. Torque to specification. See page 98.
5. Reinstall the spark plug cap.

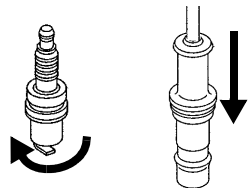

MAINTENANCE

Vehicle Immersion

If your vehicle has been totally submerged in water and it's impossible to have it serviced before further operation, perform the following procedure.



If the vehicle stops while fully submerged, major engine damage can result if the machine is not thoroughly inspected. Take the vehicle to your dealer before starting the engine.

1. Move the vehicle out of the water.

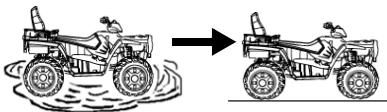

2. Remove the spark plug.

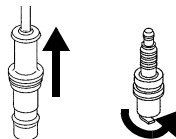

3. Drain any water found in the air box.

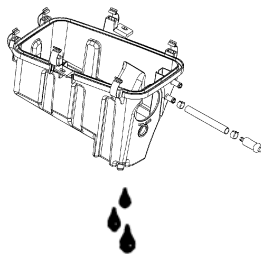

Vehicle Immersion

4. Turn the ignition key past the POSITION LIGHTS position to engage the starter. Engage the starter for only 2-3 seconds.



-
5. Dry the spark plug. Reinstall the plug or install a new plug.
 6. Torque to specification. See page 98.

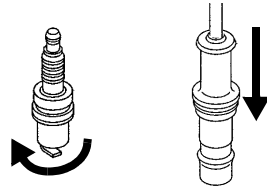

-
7. Attempt to start the engine. If necessary, repeat the drying procedure.
 8. Have the vehicle serviced by your dealer promptly, whether you succeed in starting it or not.



NOTE: If water has been ingested into the PVT, follow the procedure on page 105 for drying out the PVT.

MAINTENANCE

Spark Arrestor

Occasionally, the spark arrestor may accumulate carbon, which can restrict the exhaust if left unattended. Purge the spark arrestor.

▲ WARNING

Allow components to cool sufficiently before servicing. The exhaust system can get extremely hot. Never run the engine in an enclosed area or indoors. Exhaust contains poisonous carbon monoxide gas. Never go under the vehicle while it's inclined.

Remove any combustible materials from the area. Wear eye protection and leather work gloves. Do not stand behind or in front of the vehicle while purging.

1. Position the vehicle on a level surface.
2. Place the transmission in PARK.



3. Remove the arrestor clean-out plug from the bottom of the muffler.

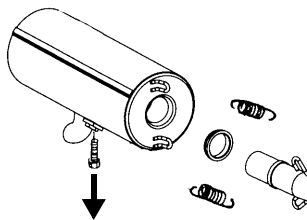

4. Start the engine.
5. Quickly squeeze and release the throttle lever several times to purge carbon from the system.

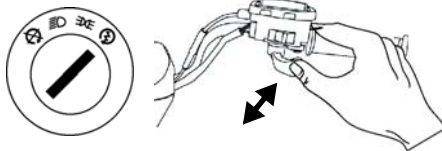

Spark Arrestor

6. If carbon comes out of the exhaust, cover or plug the exhaust outlet. Wear protective gloves.
7. Lightly tap on the exhaust pipe with a rubber mallet while repeating step 5.

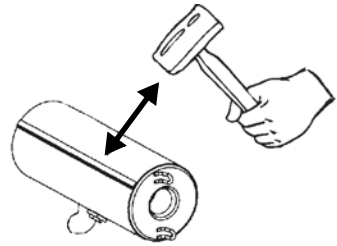

-
8. If particles are still suspected to be in the muffler, elevate the rear of the vehicle 30 cm higher than the front. Block the wheels.
 9. Place the transmission in PARK. Repeat steps 5 to 7 until no more particles are expelled.

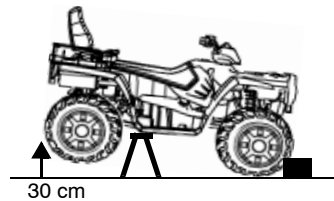

10. Stop the engine. Allow the arrestor to cool.
 11. Reinstall the arrestor plug and remove the exhaust outlet cover or plug.
-

MAINTENANCE

PVT System



Do not modify any component of the PVT system. Doing so may reduce its strength so that a failure may occur at a high speed. The PVT system has been precision balanced. Any modification will cause the system to be out of balance, creating vibration and additional loads on components.

The PVT system rotates at high speeds, creating large amounts of force on clutch components. Extensive engineering and testing has been conducted to ensure the safety of this product. However, as the owner, you have the following responsibilities to make sure this system remains safe:

- Always follow all recommended maintenance procedures. See your dealer as outlined in the owner's manual.
- This PVT system is intended for use on Polaris products only. Do not install it in any other product.
- Always make sure the PVT housing is securely in place during operation.

PVT System

PVT Drying

There may be some instances when water is accidentally ingested into the PVT system. Dry it out before operating.

1. Position the vehicle on a level surface.
2. Place the transmission in PARK.



-
3. Remove the drain plug. Allow the water to drain completely. Reinstall the drain plug.
 4. Start the engine.
 5. Apply varying throttle for 10-15 seconds to expel the moisture and air-dry the belt and clutches.

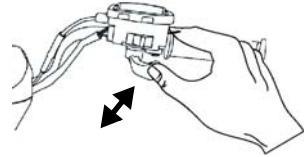

NOTE: Do not hold the throttle wide open for more than 10 seconds.

-
6. Allow the engine RPM to settle to idle speed, then shift the transmission to the lowest available range.
 7. Test for belt slippage. If the belt slips, repeat the process.
 8. Take the vehicle to your dealer for service as soon as possible.
-

MAINTENANCE

Battery

Your vehicle may have either a sealed battery, which requires little maintenance, or a conventional battery. A sealed battery can be identified by its flat covers on the top of the battery. A conventional battery has six filler caps on the top of the battery.

Always keep battery terminals and connections free of corrosion. If cleaning is necessary, remove corrosion with a stiff wire brush. Wash with a solution of one tablespoon baking soda and one cup water. Rinse well with tap water and dry off with clean shop towels. Coat the terminals with dielectric grease or petroleum jelly. Be careful not to allow cleaning solution or tap water into a conventional battery.

WARNING

Battery electrolyte is poisonous. It contains sulfuric acid. Serious burns can result from contact with skin, eyes or clothing.

Antidote:

External: Flush with water.

Internal: Drink large quantities of water or milk. Follow with milk of magnesia, beaten egg, or vegetable oil. Call physician immediately.

Eyes: Flush with water for 15 minutes and get prompt medical attention.

Batteries produce explosive gases. Keep sparks, flame, cigarettes, etc. away. Ventilate when charging or using in an enclosed space. Always shield eyes when working near batteries. **KEEP OUT OF REACH OF CHILDREN.**

Battery

WARNING

Improperly connecting or disconnecting battery cables can result in an explosion and cause serious injury or death. When removing the battery, always disconnect the negative (black) cable first. When reinstalling the battery, always connect the negative (black) cable last.

Battery Removal

1. Place the transmission in PARK.
2. Disconnect the battery hold-down strap.
3. Remove the battery cover (if equipped).
4. On conventional batteries, remove the battery vent tube.
5. Disconnect the black (negative) battery cable first.
6. Disconnect the red (positive) battery cable last.
7. Lift the battery out of the vehicle. Be careful not to tip a conventional battery sideways, which could spill electrolyte.

NOTE: If electrolyte spills, immediately wash it off with a solution of one tablespoon baking soda and one cup water to prevent damage to the vehicle.

MAINTENANCE

Battery

Battery Installation

1. Ensure that the battery is fully charged.
2. Place the battery in the battery holder.
3. With conventional batteries, install the battery vent tube (sealed batteries do not have a vent tube).

NOTE: The vent tube must be free of obstructions and securely installed. Route the tube away from the frame and vehicle body to prevent contact with electrolyte.

WARNING

Battery gases could accumulate in an improperly installed vent tube and cause an explosion, resulting in serious injury or death. Always ensure that the vent tube is free of obstructions and is securely installed as recommended.

4. On conventional batteries, coat the terminals with dielectric grease or petroleum jelly.
5. Connect and tighten the red (positive) cable first.
6. Connect and tighten the black (negative) cable last.
7. Install the battery cover (if equipped).
8. Secure the battery hold-down strap.
9. Verify that cables are properly routed.

NOTE: Cables should be safely tucked away at the front and rear of the battery.

Battery Storage

Whenever the vehicle is not used for a period of three months or more, remove the battery from the vehicle, ensure that it's fully charged, and store it out of the sun in a cool, dry place. Check battery voltage each month during storage and recharge as needed to maintain a full charge.

NOTE: Battery charge can be maintained by using a Polaris Battery Tender charger or by charging about once a month to make up for normal self-discharge. Battery Tender can be left connected during the storage period, and will automatically charge the battery if the voltage drops below a pre-determined point. See page 120 for the part numbers of Polaris products.

Battery

Battery Fluid (Conventional Battery)

Check the battery fluid level often. Maintain the fluid level between the upper and lower level marks.

Add only distilled water. Tap water contains minerals that are harmful to a battery.

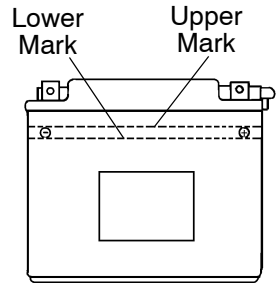

Battery Charging (Conventional Battery)

1. Remove the battery from the vehicle to prevent damage from leaking or spilled electrolyte during charging. See page 107.
2. Charge the battery with a charging output no larger than 1/10 of the battery's amp/hr rating. Charge as needed to raise the specific gravity to 1.270 or greater.
3. Reinstall the battery. See page 108. Make sure the positive terminal is toward the front of the vehicle.

Battery Charging (Sealed Battery)

The following battery charging instructions apply only to the installation of a sealed battery. Read all instructions before proceeding with the installation of this battery.

The sealed battery is already filled with electrolyte and has been sealed and *fully charged* at the factory. *Never* pry the sealing strip off or add any other fluid to this battery.

The single most important thing about maintaining a sealed battery is to keep it fully charged. Since the battery is sealed and the sealing strip cannot be removed, you must use a voltmeter or multimeter to measure DC voltage.

MAINTENANCE

Battery

Battery Charging (Sealed Battery)

For a refresh charge, follow all instructions carefully.

1. Check the battery voltage with a voltmeter or multimeter. A fully charged battery will register 12.8 V or higher.
2. If the voltage is less than 12.8 volts, recharge the battery at 1.2 amps or less until battery voltage is 12.8 or greater.

NOTE: When using an automatic charger, refer to the charger manufacturer's instructions for recharging. When using a constant current charger, use the following guidelines for recharging.

WARNING

An overheated battery may explode, causing severe injury or death. Always watch charging times carefully. Stop charging if the battery becomes very warm to the touch. Allow it to cool before resuming charging.

NOTE: Always verify battery condition before and 1-2 hours after the end of charging.

State of Charge	Voltage	Action	Charge Time (Using constant current charger @ standard amps specified on top of battery)
100%	12.8-13.0 volts	None, check at 3 mos. from date of manufacture	None required
75%-100%	12.5-12.8 volts	May need slight charge, if no charge given, check in 3 months	3-6 hours
50%-75%	12.0-12.5 volts	Needs charge	5-11 hours
25%-50%	11.5-12.0 volts	Needs charge	At least 13 hours, verify state of charge
0%-25%	11.5 volts or less	Needs charge with desulfating charger	At least 20 hours

Cleaning and Storage

Washing the Vehicle

Keeping your Polaris vehicle clean will not only improve its appearance but it can also extend the life of various components.

High water pressure may damage components. Polaris recommends washing the vehicle by hand or with a garden hose, using mild soap.

Certain products, including insect repellents and chemicals, will damage plastic surfaces. Do not allow these types of products to contact the vehicle.

1. Use a professional-type washing cloth, cleaning the upper body first and the lower parts last.
2. Rinse with clean water frequently.
3. Dry surfaces with a chamois to prevent water spots.

Washing Tips

- Avoid the use of harsh cleaners, which can scratch the finish.
- Do not use a power washer to clean the vehicle.
- Do not use medium to heavy duty compounds on the finish.
- Always use clean cloths and pads for cleaning and polishing. Old or reused cloths and pads may contain dirt particles that will scratch the finish.

MAINTENANCE

Cleaning and Storage

Washing the Vehicle

If a high pressure water system is used for cleaning (not recommended), exercise extreme caution. The water may damage components and could remove paint and decals. Avoid directing the water stream at the following items:

- Wheel bearings
- Radiator
- Transmission seals
- Brakes
- Cab and body panels
- Labels and decals
- Electrical components and wiring

NOTE: If warning and safety labels are damaged, contact your Polaris dealer for free replacement.

Grease all zerk fittings immediately after washing. Allow the engine to run for a while to evaporate any water that may have entered the engine or exhaust system.

Polishing the Vehicle

Polaris recommends the use of common household aerosol furniture polish for polishing the finish on your Polaris vehicle. Follow the instructions on the container.

Polishing Tips

- Avoid the use of automotive products, some of which can scratch the finish of your vehicle.
- Always use clean cloths and pads for cleaning and polishing. Old or reused cloths and pads may contain dirt particles that will scratch the finish.

Cleaning and Storage

Chrome Wheel Care (if equipped)

Proper maintenance will protect chrome wheels from corrosion, preserve wheel life and ensure a "like new" appearance for many years.

NOTE: Chrome wheels exposed to road salt (or salt in the air in coastal areas) are more susceptible to corrosion if not properly cleaned. Clean chrome wheels more often if they're exposed to salt or other corrosive elements.

1. Wash chrome wheels frequently. Use a mild detergent. Never use abrasive cleaners on plated or painted surfaces.
2. Rinse well with clear water. Soap, detergents, salt, dirt, mud and other elements can cause corrosion.
3. Polish the clean chrome wheels periodically. Use an automotive grade chrome polish.
4. Routinely and liberally apply a weather resistant wax to each polished chrome wheel. Choose a product suitable for chrome finishes. Read and follow the product labels and instructions.

Removing Corrosion

If light rust is found on the chrome finish, use steel wool (#0000-OTT grade) to remove it. Gently rub the affected areas with the steel wool until the corrosion has been removed. Clean and polish the wheel as outlined above.

MAINTENANCE

Cleaning and Storage

Storage Tips



Starting the engine during the storage period will disturb the protective film created by fogging and damage could occur. Never start the engine during the storage period.

Clean the Exterior

Make any necessary repairs and clean the vehicle as recommended. See page 111.

Stabilize the Fuel

1. Fill the fuel tank.
2. Add Polaris Carbon Clean Fuel Treatment or Polaris Fuel Stabilizer. Follow the instructions on the container for the recommended amount.

NOTE: Carbon Clean removes water from fuel systems, stabilizes fuel and removes carbon deposits from pistons, rings, valves and exhaust systems.

3. Allow the engine to run for 15-20 minutes to allow the stabilizer to disperse through the entire fuel delivery system.

Oil and Filter

Change the oil and filter. See page 72.

Air Filter / Air Box

1. Inspect and clean (or replace) the pre-cleaner and air filter. See page 92.
2. Clean the air box.
3. Clean or replace the breather filter. See page 93.
4. Drain the sediment tube.

Cleaning and Storage

Storage Tips

Fluid Levels

Inspect the fluid levels. Add or change fluids as recommended in the Periodic Maintenance Chart beginning on page 65.

- Demand drive unit (front gearcase)
- ADC fluid (change every two years)
- Rear gearcase (if equipped)
- Transmission
- Brake fluid (change every two years and any time the fluid looks dark or contaminated)
- Coolant (test strength/fill)

Fog the Engine

1. Treat the fuel system with Polaris Carbon Clean. See page 114.
2. Remove the spark plug. Pour 30-45 ml of engine oil into the plug holes.
3. Reinstall the spark plug. Torque to specification.
4. Apply dielectric grease to the inside of each spark plug cap. Reinstall the caps.
5. Turn the engine over several times. Oil will be forced in and around the piston rings and ring lands, coating the cylinder with a protective film of fresh oil.
6. If Polaris fuel system additive is not used, the fuel tank, fuel lines, and injectors should be completely drained of gasoline.

MAINTENANCE

Cleaning and Storage

Storage Tips

Inspect and Lubricate

Inspect all cables and lubricate all areas of the vehicle as recommended in the Periodic Maintenance Chart beginning on page 65.

Battery Storage

See pages 108-109 for storage and charging procedures.

Storage Area/Covers

1. Set the tire pressure and safely support the vehicle with the tires slightly off the ground.
2. Be sure the storage area is well ventilated.
3. Cover the vehicle with a genuine Polaris cover. Do not use plastic or coated materials. They do not allow enough ventilation to prevent condensation, and may promote corrosion and oxidation.

Accessories

Auxiliary power outlets provide 12-volt power for operating accessories. Accessory outlets are available for all models. Polaris also has a wide range of additional accessories available for your vehicle. Always install accessories that are approved for Quadricycle use. Please see your Polaris dealer.

Transporting the Vehicle

Follow these procedures when transporting the vehicle.

1. Stop the engine.
2. Place the transmission in PARK.
3. Secure the fuel cap, oil cap and seat.

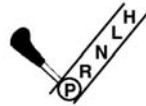

4. Remove the key to prevent loss during transporting.



5. Always tie the frame of the Quadricycle to the transporting unit securely with suitable straps or rope. Do not attach tie straps to the front A-arm bolt pockets.

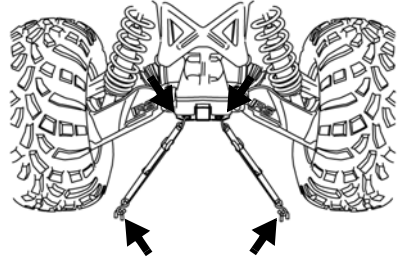
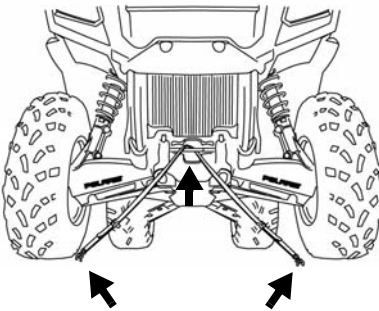

Towing a Disabled Vehicle

If towing the vehicle is necessary, shift the transmission into neutral for better mobility and to prevent damage to the belt.

Always attach the tow rope to the frame of the Quadricycle.

SPECIFICATIONS

Sportsman 800 Touring Quadricycle	
Maximum Weight Capacity	568 lbs. (258 kg) (includes operator, passenger, cargo, accessories)
Dry Weight	795 lbs. (361 kg)
Front Rack/Storage Box Capacity	90 lbs. (41 kg)
Rear Rack Capacity	180 lbs. (82 kg)
Receiver Hitch Tongue Capacity	150 lbs. (68 kg) (Rear rack capacity and tongue weight not to exceed 180 lbs. (82 kg))
Hitch Towing Rating	1500 lbs. (680.4 kg) on level ground
Unbraked Trailer Towing Capacity*	1995 lbs. (905 kg)
Overall Length	86 in. (218 cm)
Overall Width	48 in. (122 cm)
Overall Height	48 in. (122 cm)
Wheelbase	57 in. (145 cm)
Ground Clearance	11 in. (28 cm)
Minimum Turning Radius	82 in. (208 cm) unloaded
Fuel Capacity	5.4 gal. (20.5 l)
Engine Oil Capacity	2 qts. (1.9 l)
Coolant Capacity	3.4 qts. (3.2 l)
Demand Drive Fluid Capacity	9.3 oz. (275 ml)
Transmission Oil Capacity	32 oz. (948 ml)
Engine	EH0760LE
Displacement	760 cc
Bore x Stroke	80mm x 76mm
Alternator Output	500 Watts @3000 RPM
Compression Ratio	10:1
Fuel System	Electronic Fuel Injection
Ignition System	Electronic Ignition
Ignition Timing	Variable - ECU controlled
Spark Plug	RC7YC
Spark Plug Gap	.035 in. (0.9 mm)
Lubrication System	Pressurized Wet Sump
Driving System Type	Automatic PVT (Polaris Variable Transmission)
Front Suspension	MacPherson strut with 8.2" (21 cm) travel
Rear Suspension	Progressive rate with 8.75" (22 cm) travel

* Based on EU Directive 76/432/EC

SPECIFICATIONS

Sportsman 800 Touring Quadricycle

Transmission	Automatic EBS (Engine Braking System) w/E-Z Shift H/L/N/R/P
Gear Reduction, Low	23.91:1
Gear Reduction, Reverse	21.74:1
Gear Reduction, High	8.28:1
Drive Ratio, Front	3.82:1
Tires/Pressure, Front	25x8-12 / 5 psi (34.5 KPa)
Tires/Pressure, Rear	25x11-12 / 5 psi (34.5 KPa)
Brake, Hand	All-wheel hydraulic disc
Brake, Foot	All-wheel hydraulic disc
Brake, Parking	Transmission park lock and hydraulic lock, all wheel
Headlight	2 Hi/Lo beam on bumper (37.5 watt)
Taillights	8.26 watts
Brake Light	26.9 watts
Instrument Cluster	LCD

Clutching (EBS Models)

Altitude		Shift Weight	Drive Clutch Spring	Driven Clutch Spring	Helix*
Meters (Feet)	0-1800 (0-6000)	21-74 PN 5632117	Red/Blue PN 7043372	Red PN 3234452	66-56-33 BA500 EBS PN 3234604
	1800-3700 (6000-12000)	21-70 PN 5632127			

NOTE: *EBS models require no helix/spring adjustment

POLARIS PRODUCTS

Part Number	Description
Engine Lubricant	
2870791	Fogging Oil (12 oz. Aerosol)
2876244	PS-4 PLUS Performance Synthetic 2W-50 4-Cycle Oil (.95 l)
2876245	PS-4 PLUS Performance Synthetic 2W-50 4-Cycle Oil (3.8 l)
Gearcase / Transmission Lubricants	
2873602	Premium AGL Synthetic Gearcase Lubricant (.95 l)
2873603	Premium AGL Synthetic Gearcase Lube (3.8 l)
2876144	Active Descent Control (ADC) Fluid
2871653	Premium ATV Angle Drive Fluid (237 ml)
2872276	Premium ATV Angle Drive Fluid (9.5 l)
2870465	Pump for Gallon (3.8 l) Jug
2876251	Demand Drive LT Premium Fluid (237 ml)
Coolant	
2871323	60/40 Coolant (3.8 l)
2871534	60/40 Coolant (.95 l)
Grease / Specialized Lubricants	
2871312	Grease Gun Kit, Premium All Season
2871322	Premium All Season Grease (89 ml cartridge)
2871423	Premium All Season Grease (414 ml cartridge)
2871460	Starter Drive Grease
2871515	Premium U-Joint Lube (89 ml)
2871551	Premium U-Joint Lube (414 ml)
2871329	Dielectric Grease (Nyogel™)
2872073	Chain Lube, Aerosol (185 ml)
2872348	Chain Lube, Aerosol (473 ml)
Additives / Miscellaneous	
2871326	Carbon Clean Plus
2870652	Fuel Stabilizer
2872189	DOT4 Brake Fluid
2871956	Loctite™ 565 Thread Sealant
2859044	Polaris Battery Tender™ Charger

TROUBLESHOOTING

Drive Belt Wear/Burn

Possible Cause	Solution
Driving onto a pickup or tall trailer in high range	Use low range.
Starting out going up a steep incline	Use low range or turn around using the K-turn (see page 54).
Driving at low RPM or ground speed (5-11 kmh)	Drive at a higher speed or use low range more frequently.
Insufficient warm-up at low ambient temperatures	Warm the engine at least 5 minutes. With the transmission in neutral, advance the throttle to about 1/8 throttle in short bursts, 5 to 7 times. The belt will become more flexible and prevent belt burning.
Slow/easy clutch engagement	Use the throttle quickly and effectively.
Towing/pushing at low RPM/low ground speed	Use low range only.
Utility use/plowing	Use low range only.
Stuck in mud or snow	Shift the transmission to low range. Carefully use fast, aggressive throttle application to engage clutch.
Climbing over large objects from a stopped position	WARNING: Excessive throttle may cause loss of control and vehicle overturn.
Belt slippage from water or snow ingestion into the PVT system	Dry out the PVT. See page 105. Inspect clutch seals for damage if repeated leaking occurs.
Clutch malfunction	See your Polaris dealer.
Poor engine performance	Check for fouled plugs or foreign material in gas tank or fuel lines. See your dealer.
Slippage from failure to warm up belt	Always warm up the belt by operating below 48 km/h for 1.6 km. Operate 8 km or more when temperature is below freezing.
Wrong or missing belt	Install the recommended belt.
Improper break-in	Always break in a new belt and/or clutch. See page 42.

TROUBLESHOOTING

Engine Does Not Rotate

Possible Cause	Solution
Low battery voltage	Recharge the battery to 12.8 VDC
Loose battery connections	Check all connections and tighten
Loose solenoid connections	Check all connections and tighten

Engine Rotates, Fails to Start

Possible Cause	Solution
Out of fuel	Refuel
Clogged fuel filter	Replace the filter
Water is present in fuel	Drain the fuel system and refuel
Old or non-recommended fuel	Replace with fresh recommended fuel
Fouled or defective spark plug(s)	Inspect plugs and replace if necessary
No spark to spark plug	Inspect plugs, verify stop switch is on
Water or fuel in crankcase	Immediately see your Polaris dealer
Low battery voltage	Recharge the battery to 12.8 VDC
Mechanical failure	See your dealer

Engine Backfires

Possible Cause	Solution
Weak spark from spark plug	Inspect, clean and/or replace spark plug(s)
Incorrect spark plug gap or heat range	Set gap to specs or replace plugs
Old or non-recommended fuel	
Loose ignition connections	Check all connections and tighten
Water present in fuel	Replace with fresh recommended fuel
Incorrectly installed spark plug wires	See your dealer
Incorrect ignition timing	See your dealer
Mechanical failure	See your dealer

TROUBLESHOOTING

Engine Pings or Knocks

Possible Cause	Solution
Poor quality or low octane fuel	Replace with recommended fuel
Incorrect ignition timing	See your dealer
Incorrect spark plug gap or heat range	Set gap to specs or replace plugs

Engine Runs Irregularly, Stalls or Misfires

Possible Cause	Solution
Fouled or defective spark plug(s)	Inspect, clean and/or replace spark plug(s)
Worn or defective spark plug wires	See your dealer
Incorrect spark plug gap or heat range	Set gap to specs or replace plugs
Loose ignition connections	Check all connections and tighten
Water present in fuel	Replace with new fuel
Low battery voltage	Recharge battery to 12.8 VDC
Kinked or plugged fuel tank vent line	Inspect and replace
Incorrect fuel	Replace with recommended fuel
Clogged air filter	Inspect and clean or replace
Reverse speed limiter malfunction	See your dealer
Electronic throttle control malfunction	See your dealer
Other mechanical failure	See your dealer

Possible Lean Fuel Cause	Solution
Low or contaminated fuel	Add or change fuel, clean the fuel system
Low octane fuel	Replace with recommended fuel
Clogged fuel filter	Replace filter
Kinked or plugged fuel vent line	Inspect and replace (if equipped)

Possible Rich Fuel Cause	Solution
Fuel is very high octane	Replace with lower octane fuel
Stopping/starting without adequate warm-up	Allow engine to warm up before operating and/or stopping
Incorrect fuel	Replace with recommended fuel
Clogged air filter	Inspect and clean or replace

TROUBLESHOOTING

Engine Stops or Loses Power

Possible Cause	Solution
Out of fuel	Refuel, cycle key to ON position three times for 5 seconds each, then start
Kinked or plugged fuel vent line	Inspect and replace (if equipped)
Water is present in fuel	Replace with fresh recommended fuel
Old or non-recommended fuel	Replace with fresh recommended fuel
Fouled or defective spark plug(s)	Inspect, clean and/or replace spark plug(s)
Worn or defective spark plug wires	See your dealer
Incorrect spark plug gap or heat range	Set gap to specs or replace plug
Loose ignition connections	Check all connections and tighten
Low battery voltage	Recharge the battery to 12.8 VDC
Clogged air filter	Inspect and clean or replace
Reverse speed limiter malfunction	See your dealer
Electronic throttle control malfunction	See your dealer
Other mechanical failure	See your dealer
Overheated engine	Clean radiator screen and core, clean engine exterior, see your dealer

Engine Overheating

Possible Cause	Solution
Debris lodged in screen	Remove and clean the screen. Pull on the top portion of the screen, then remove the lower portion.
Plugged Radiator	Use a garden hose to flush any debris from the radiator fins. NOTE: High pressure washers can deform the radiator fins and reduce cooling efficiency.

WARRANTY

LIMITED WARRANTY

Polaris Industries Inc., 2100 Highway 55, Medina, MN 55340, gives a TWO YEAR LIMITED WARRANTY on all components of the Polaris Quadricycle against defects in material or workmanship. This warranty covers the parts and labor charges for repair or replacement of defective parts which are covered by this warranty. This warranty begins on the date of purchase. This warranty is transferable to another consumer during the warranty period through a Polaris dealer.

REGISTRATION

At the time of sale, the Warranty Registration Form must be completed by your dealer and submitted to Polaris within ten days. Upon receipt of this registration, Polaris will record the registration for warranty. **THE PURCHASER MUST COMPLETE A QUADRICYCLE SAFETY TRAINING COURSE PROVIDED BY THE DEALER IN ORDER TO HAVE VALID WARRANTY ON THE QUADRICYCLE.** No verification of registration will be sent to the purchaser as the copy of the Warranty Registration Form will be the warranty entitlement. If you have not signed the original registration and received the "customer copy", please contact your dealer immediately. **NO WARRANTY COVERAGE WILL BE ALLOWED UNLESS YOUR QUADRICYCLE IS REGISTERED WITH POLARIS.**

Initial dealer preparation and set-up of your vehicle is very important in ensuring trouble-free operation. Purchasing a machine in the crate or without proper dealer set-up will void your warranty coverage.

WARRANTY

WARRANTY COVERAGE AND EXCLUSIONS: LIMITATIONS OF WARRANTIES AND REMEDIES

The Polaris limited warranty excludes any failures that are not caused by a defect in material or workmanship. This warranty does not cover accidental damage, normal wear and tear, abuse or improper handling. This warranty also does not cover any Quadricycle that has been altered structurally, modified, neglected, improperly maintained, used for racing, or used for purposes other than for which it was manufactured, or for any damages which occur during trailer transit or as a result of unauthorized service or the use of unauthorized parts. In addition, this warranty does not cover physical damage to paint or finish, stress cracks, tearing or puncturing of upholstery material, corrosion, or defects in parts, components or the vehicle due to fire, explosions or any other cause beyond Polaris' control.

This warranty does not cover the use of unauthorized lubricants, chemicals, or fuels that are not compatible with the Quadricycle. The exclusive remedy for breach of this warranty shall be, at Polaris' exclusive option, repair or replacement of any defective materials, or components or products. **THE REMEDIES SET FORTH IN THIS WARRANTY ARE THE ONLY REMEDIES AVAILABLE TO ANY PERSON FOR BREACH OF THIS WARRANTY. POLARIS SHALL HAVE NO LIABILITY TO ANY PERSON FOR INCIDENTAL, CONSEQUENTIAL OR SPECIAL DAMAGES OF ANY DESCRIPTION, WHETHER ARISING OUT OF EXPRESS OR IMPLIED WARRANTY OR ANY OTHER CONTRACT, NEGLIGENCE, OR OTHER TORT OR OTHERWISE.** Some states do not permit the exclusion or limitation of incidental or consequential damages or implied warranties, so the above limitations or exclusions may not apply to you if inconsistent with controlling state law.

ALL IMPLIED WARRANTIES (INCLUDING BUT NOT LIMITED TO THE IMPLIED WARRANTIES OF MERCHANTABILITY AND FITNESS FOR A PARTICULAR PURPOSE) ARE LIMITED IN DURATION TO THE ABOVE TWO YEAR WARRANTY PERIOD. POLARIS FURTHER DISCLAIMS ALL EXPRESS WARRANTIES NOT STATED IN THIS WARRANTY. Some states do not allow limitations on how long an implied warranty lasts, so the above limitation may not apply to you if inconsistent with controlling state law.

WARRANTY

HOW TO OBTAIN WARRANTY SERVICE

If your Quadricycle requires warranty service, you must take it to a Polaris dealer authorized to repair Polaris Quadricycles. When requesting warranty service you must present your copy of the Warranty Registration form to the dealer. (THE COST OF TRANSPORTATION TO AND FROM THE DEALER IS YOUR RESPONSIBILITY). Polaris suggests that you use your original selling dealer; however, you may use any Polaris Servicing Dealer to perform warranty service.

Please work with your dealer to resolve any warranty issues. Should your dealer require any additional assistance they will contact the appropriate personnel at Polaris.

This warranty gives you specific legal rights, and you may also have other rights which vary from state to state.

If any of the above terms are void because of state or federal law, all other warranty terms will remain in effect.

MAINTENANCE LOG

DATE	KILOMETERS OR HOURS	TECHNICIAN	SERVICE PERFORMED / COMMENTS

Free Manuals Download Website

<http://myh66.com>

<http://usermanuals.us>

<http://www.somanuals.com>

<http://www.4manuals.cc>

<http://www.manual-lib.com>

<http://www.404manual.com>

<http://www.luxmanual.com>

<http://aubethermostatmanual.com>

Golf course search by state

<http://golfingnear.com>

Email search by domain

<http://emailbydomain.com>

Auto manuals search

<http://auto.somanuals.com>

TV manuals search

<http://tv.somanuals.com>