

24" Color Television

TTM-2401

Operating Manual



20050503



Contents

Congratulations on your purchase of this color television.

We recommend that you thoroughly read this manual before use to fully enjoy the many functions and excellent features of this equipment.

Retain this manual in an easily accessible location for future reference.

* Screen displays and illustrations in this manual may differ from the actual ones for better visibility.

Contents

Important Safety Instructions	2
Identification of Controls	4
Antenna connection	6
Preparing the remote control.....	7
External equipment connections.....	8
Power On/Off	10
Selecting input signal	11
Tuning In	12
Channel Selection	14
Picture adjustment.....	15
Sound controls	16
Timer Setting	17
System Settings	19
Closed Captions	20
Setting Parental Control	21
Troubleshooting Guide	25

Important safety instructions



CAUTION

RISK OF ELECTRIC SHOCK
DO NOT OPEN



CAUTION: TO REDUCE THE RISK OF ELECTRIC SHOCK, DO NOT REMOVE COVER(OR BACK). NO USER-SERVICEABLE PARTS INSIDE. REFER SERVICING TO QUALIFIED SERVICE PERSONNEL.

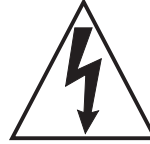

The lightning flash with arrowhead symbol, within an equilateral triangle is intended to alert the user to the presence of uninsulated dangerous voltage within the product's enclosure that may be of sufficient magnitude to constitute a risk of electric shock to persons.



The exclamation point within an equilateral triangle is intended to alert the user to the presence of important operating and maintenance (servicing) instructions in the literature accompanying the appliance.

WARNING: TO REDUCE THE RISK OF FIRE OR ELECTRIC SHOCK, DO NOT EXPOSE THIS APPLIANCE TO RAIN OR MOISTURE.

Before using the unit, be sure to read all operating instructions carefully. Please note that these are general precautions and may not pertain to your particular unit. For example, this unit may not have the capability to be connected to an outdoor antenna.

1. READ INSTRUCTIONS

All the safety and operating instructions should be read before the product is operated.

2. RETAIN INSTRUCTIONS

The safety and operating instructions should be retained for future reference.

3. HEED WARNINGS

All warnings on the product and in the operating instructions should be adhered to.

4. FOLLOW INSTRUCTIONS

All operating and use instructions should be followed.

5. CLEANING

Unplug this product from the wall outlet before cleaning. Do not use liquid cleaners or aerosol cleaners. Use a damp cloth for cleaning.

6. ATTACHMENTS

Do not use attachments not recommended by the product's manufacturer as they may cause hazards.

7. WATER AND MOISTURE

Do not use this product near water (a bathtub, washbowl, kitchen sink, laundry tub, wet basement, or swimming pool for example)

8. ACCESSORIES

Do not place this product on an unstable cart, stand, tripod, bracket, or table. The product may fall, causing serious injury and serious damage to the product. Use only with a cart, stand, tripod, bracket, or table recommended by the manufacturer or sold with the product. Any mounting of the product should follow the manufacturer's instructions and should use a mounting accessory recommended by the manufacturer.

8A. An appliance and cart combination should be moved with care. Quick stops, excessive force, and uneven surfaces may cause the appliance and cart combination to overturn.

9. VENTILATION

Slots and openings in the cabinet and in the back or bottom are provided for ventilation to ensure reliable operation of the product and to protect it from overheating. These openings must not be blocked or covered. The openings should never be blocked by placing the product on a bed, sofa, rug, or other similar surface. This product should never be placed near or over a radiator or heat source. This product should not be placed in a built-in installation such as a bookcase or rack unless proper ventilation is provided or the manufacturer's instructions have been adhered to.

10. POWER SOURCES

This product should be operated only from the type of power source indicated on the marking label. If you are not sure of the type of power supply to your home, consult your appliance dealer or local power company. For products intended to operate from battery power, or other sources, refer to the operating instructions.

11. GROUNDING OR POLARIZATION

This product is equipped with a polarized alternating current line plug (a plug having one blade wider than the other). This plug will fit into the power outlet only one way. This is a safety feature. If you are unable to insert the plug fully into the outlet, try reversing the plug. If the plug should still fail to fit, contact your electrician to replace your obsolete outlet. Do not defeat the safety purpose of the polarized plug.

12. POWER-CORD PROTECTION

Power-supply cords should be routed so that they are not likely to be walked on or pinched by items placed upon or against them, paying particular attention to cords at plugs, convenience receptacles, and the point where they exit from the appliance.

PORTABLE CART WARNING
(symbol provided by RETAC)



S3126A

Important safety instructions

13. LIGHTNING

To protect your product from a lightning storm, or when it is left unattended and unused for long periods of time, unplug it from the wall outlet and disconnect the antenna or cable system. This will prevent damage to the product due to lightning and power-line surges.

14. POWER LINES

An outside antenna system should not be located in the vicinity of overhead power lines or other electric light or power circuits, or where it can fall into such power lines or circuits. When installing an outside antenna system, extreme care should be taken to keep from touching power lines or circuits as contact with them might be fatal.

15. OVERLOADING

Do not overload wall outlets and extension cords as this can result in a risk of fire or electric shock.

16. OBJECT AND LIQUID ENTRY

Never push objects of any kind through openings in the product as they may touch dangerous voltage points or short out parts that could result in fire or electric shock. Never spill or spray any type of liquid on the product.

17. OUTDOOR ANTENNA GROUNDING

If an outside antenna is connected to the product, be sure the antenna system is grounded so as to provide some protection against voltage surges and built-up static charges. Section 810 of the National Electric Code, ANSI/NFPA 70, provides information with respect to proper grounding of the mast and supporting structure, grounding of the lead-in wire to an antenna discharge product, size of grounding conductors, location of antenna discharge product, connection to grounding electrodes, and requirements for grounding electrodes.

18. SERVICING

Do not attempt to service this product yourself as opening or removing covers may expose you to dangerous voltage or other hazards. Refer all servicing to qualified service personnel.

19. REPLACEMENT PARTS

When replacement parts are required, be sure the service technician uses replacement parts specified by the manufacturer or those that have the same characteristics as the original part. Unauthorized substitutions may result in fire, electric shock or other hazards.

20. SAFETY CHECK

Upon completion of any service or repairs to this product, ask the service technician to perform safety checks to determine that the product is in proper operating condition.

21. WALL OR CEILING MOUNTING

The product should be mounted to a wall or ceiling only as recommended by the manufacturer.

22. DAMAGE REQUIRING SERVICE

Unplug the product from the wall outlet and refer servicing to qualified service personnel under the following conditions:

- When the power-supply cord or plug is damaged.
- If liquid has been spilled, or objects have fallen into the product.
- If the product has been exposed to rain or water.
- If the product does not operate normally after installation by following the operating instructions. Adjust only those controls that are covered by the operating instructions, as adjustment of other controls may result in damage and will often require extensive work by a qualified technician to restore the product to its normal operation.
- If the product has been dropped or the cabinet has been damaged.
- When the product exhibits a distinct change in performance.

23. HEAT

The product should be situated away from heat sources such as radiators, heat registers, stoves, or other products (including amplifiers) that produce heat.

24. NOTE TO CATV SYSTEM INSTALLER

This reminder is provided to call the CATV system installer's attention to Article 820-40 of the NEC that provides guidelines for proper grounding and, in particular, specifies that the cable ground shall be connected to the grounding system of the building, as close to the point of cable entry as practical.

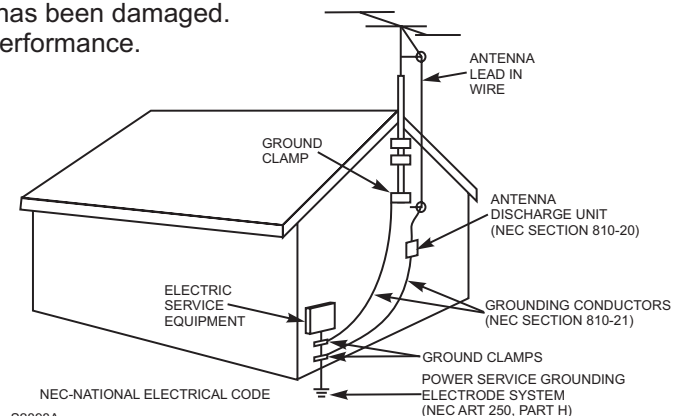

EXAMPLE OF ANTENNA GROUNDING AS PER NATIONAL ELECTRICAL CODE

WARNING: FOR CONTINUED SAFETY, REPLACE SAFETY CRITICAL COMPONENTS ONLY WITH MANUFACTURER'S RECOMMENDED PARTS (REFER TO SERVICE LITERATURE).

Identification of Controls

Front

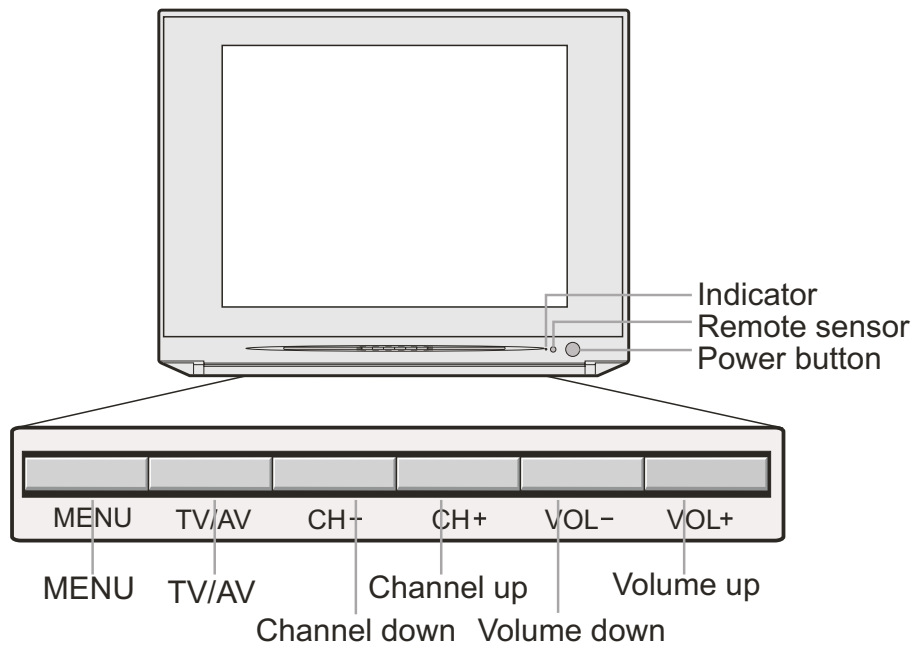

Back

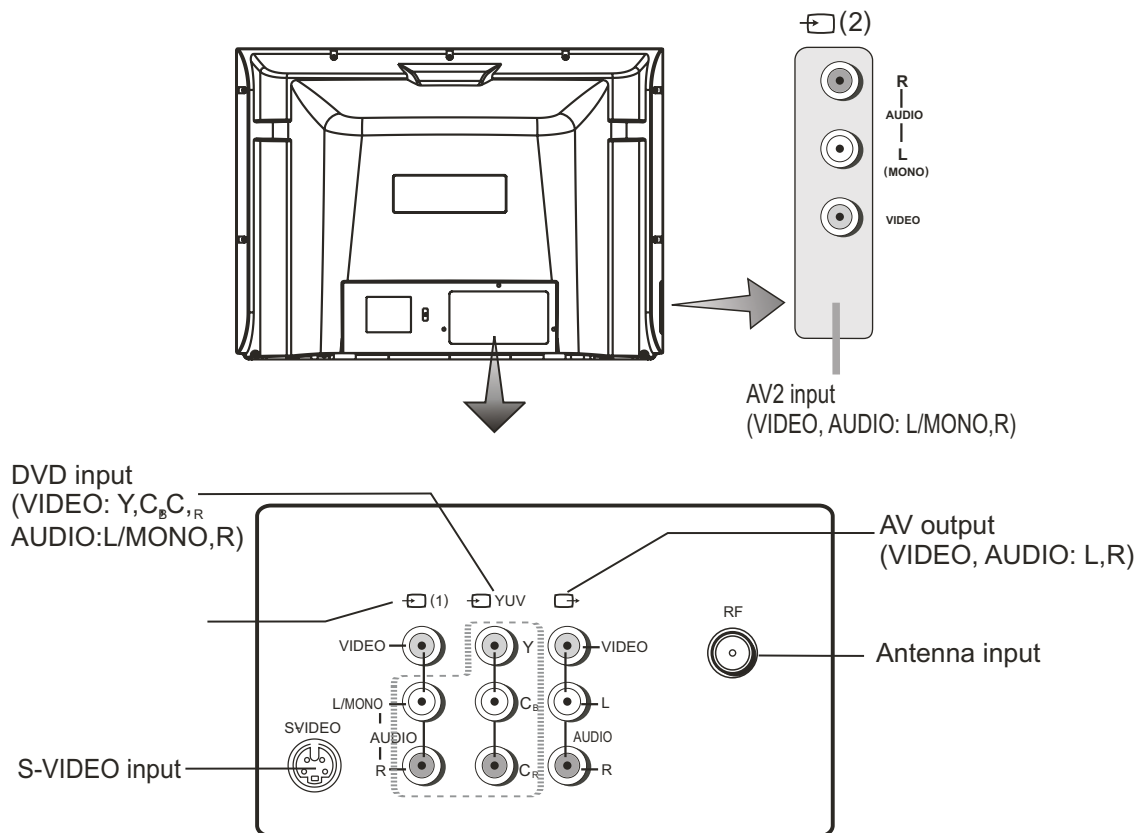

Identification of Controls

Remote control

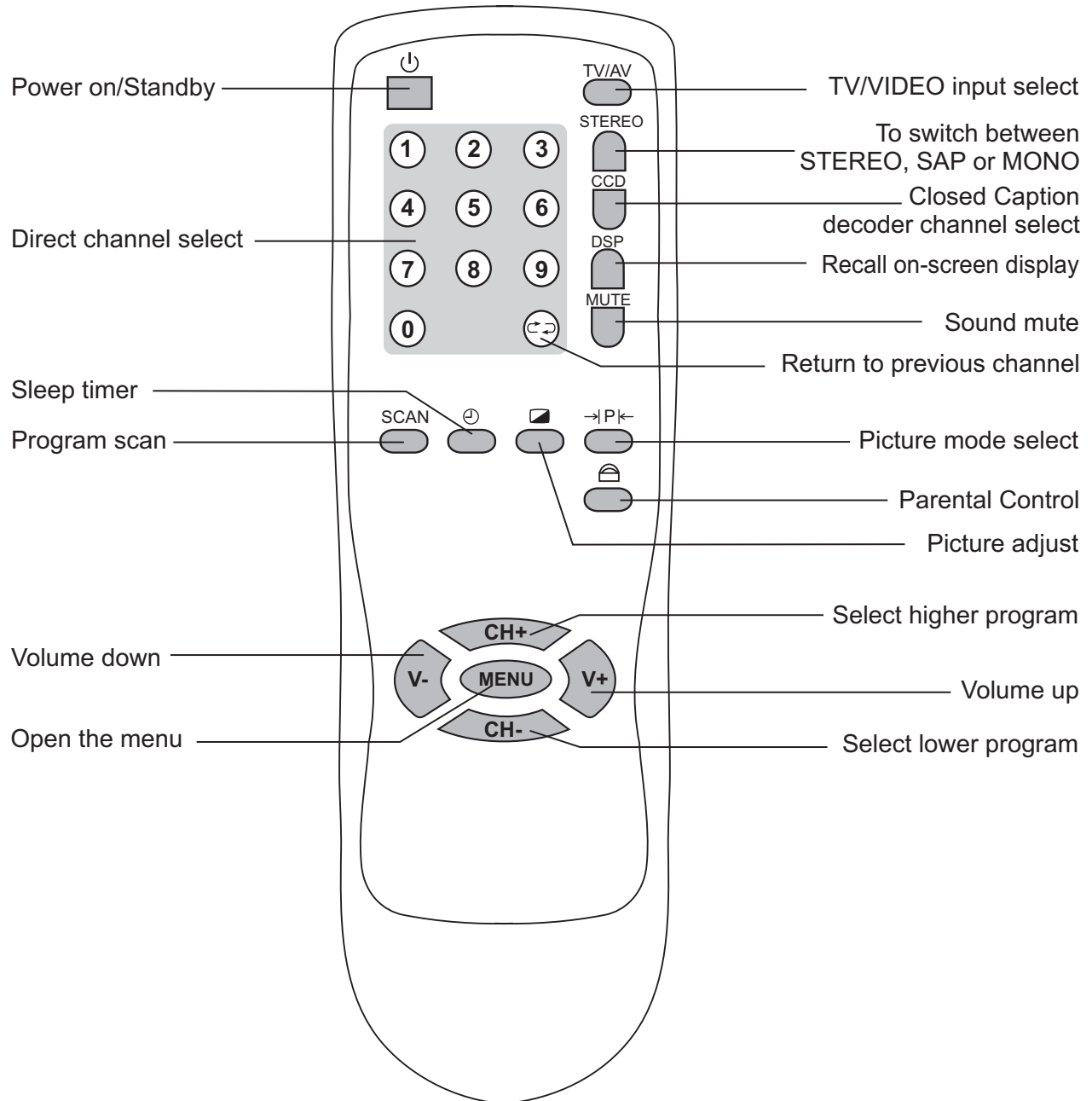

Antenna connection

CABLE TV (CATV) CONNECTION

A 75-ohm coaxial cable connector is built into the set for easy hookup. When connecting the 75-ohm coaxial cable to the set, screw the 75-ohm cable to the ANT. Terminal.

Some cable TV companies offer "premium pay channels". Since the signals of these premium pay channels are scrambled, a cable TV converter/descrambler is generally provided to the subscriber by the cable TV company.

This converter/descrambler is necessary for normal viewing of the scrambled channels. For more specific instructions on installing cable TV, consult your cable TV company. One way to utilize the converter/descrambler provided by your cable TV company is explained below. Please note: An RF switch provided with two inputs (A and B) is required (not supplied).

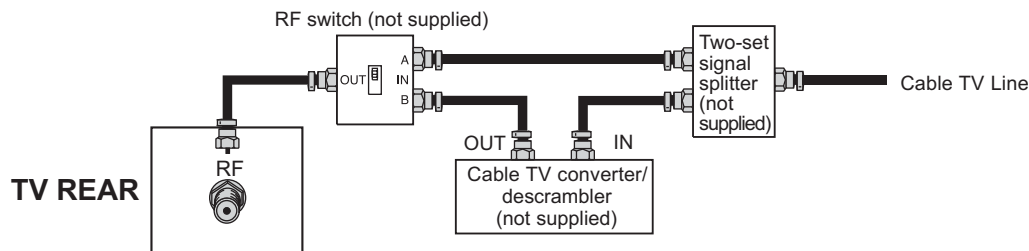

"A" position on the RF switch (not supplied): You can view all unscrambled channels by using the TV's channel keys.
 "B" position on the RF switch (not supplied): You can view the scrambled channels via the converter/descrambler by using the converter's channel keys.

Note: Consult your Dealer or Service Center for the type of splitter, RF switch or combiner that might be required.

ANTENNAS

The antenna requirements for good color television reception are more important than those for black & white television reception. For this reason, a good quality outdoor antenna is strongly recommended.

The following is a brief explanation of the type of connections that are provided with the various antenna systems.

1. A 75-ohm system is generally a round cable with F-type connector that can easily be attached to a terminal without tools (not supplied).
2. A 300-ohm system is a flat "twin-lead" cable that can be attached to a 75-ohm terminal through a 300-75-ohm adapter (not supplied).

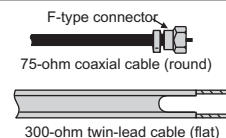

OUTDOOR ANTENNA CONNECTION

Use one of the following two diagrams if you connect an outdoor antenna.

A: Using a VHF/UHF combination outdoor antenna.

B: Using separate VHF and/or UHF outdoor antennas.

Connect the outdoor antenna cable lead-in to the ANT. terminal on the rear of the TV set.

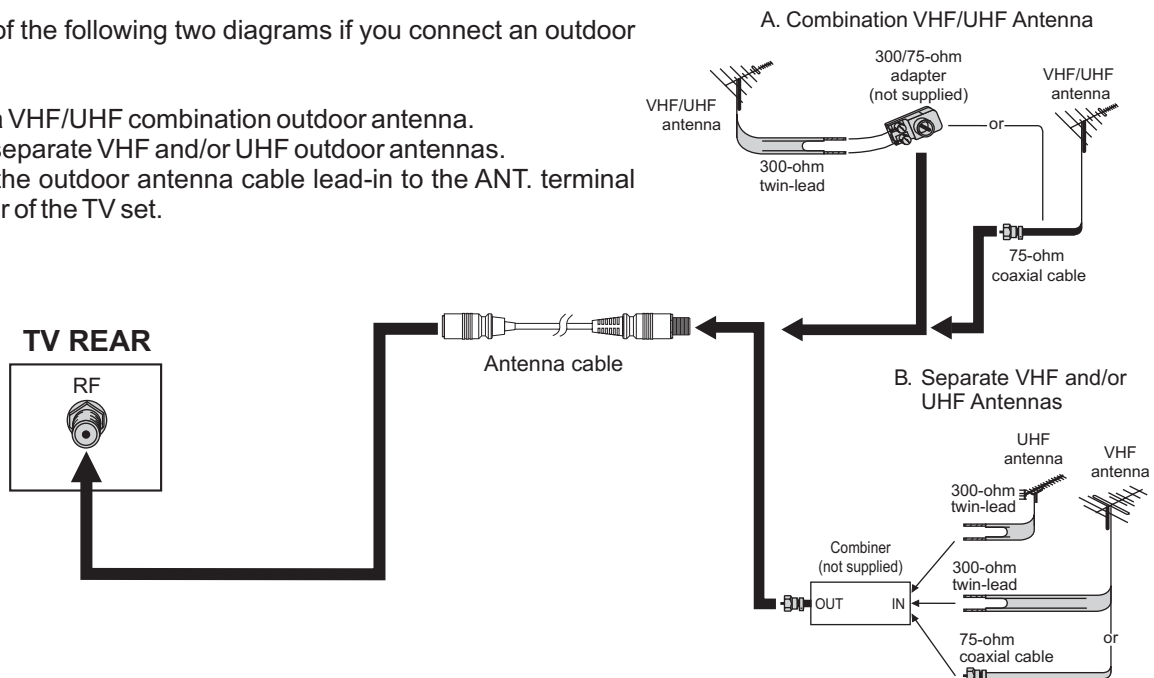

Preparing the remote control

Installing batteries

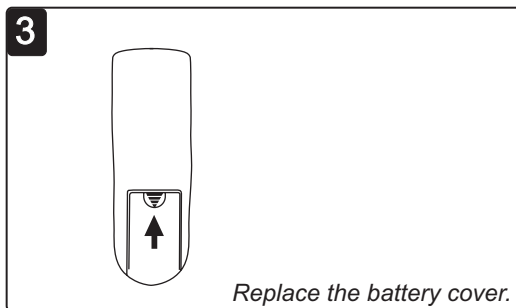
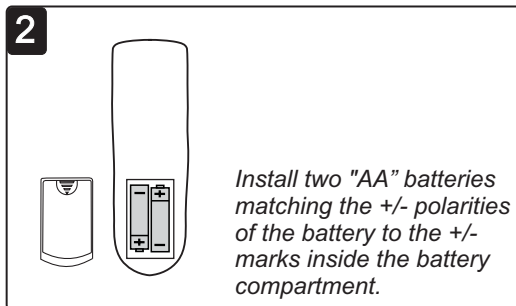
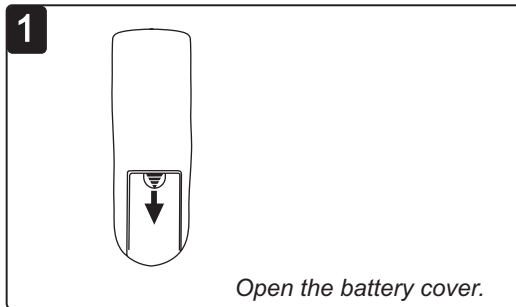

! Notes:

- Do not recharge batteries that are not intended to be recharged.
- Use only the size and type of batteries specified. Do not mix different types of batteries together or old batteries with fresh ones.
- When the remote control will not be used for a long period of time or when the batteries are worn out, remove the batteries.
- Do not throw the batteries into a fire. Recycle used batteries in the specified manner.
- Do not drop, dampen or disassemble the remote control.

Effective range of the Remote

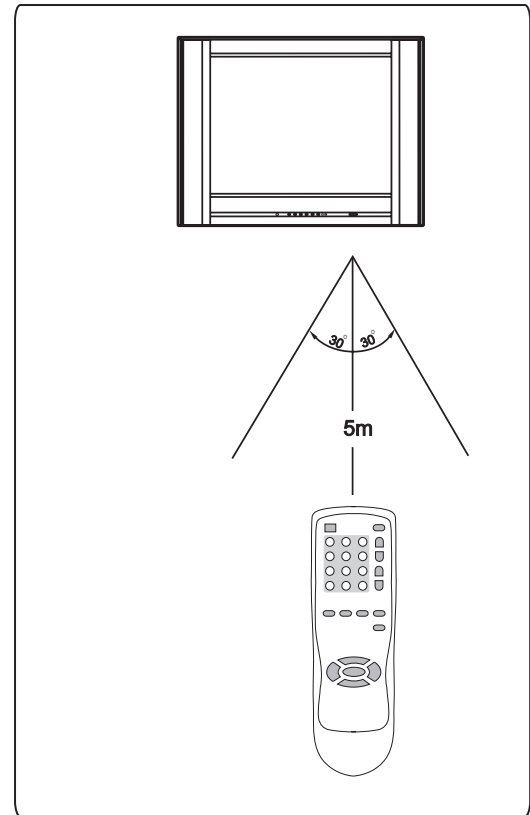

Notes:

- When there is an obstacle between the TV and the transmitter, the transmitter may not operate.
- When direct sunlight, and incandescent lamp, fluorescent lamp or any other strong light shines on the REMOTE SENSOR of the TV, the remote operation may be unstable.

External equipment connections

The following steps describe how to use and connect the TV with other AV equipment (for example, VTR, Video Camera, DVD, Video game, etc.) Please refer to the owner's manual of the equipment to be connected before proceeding.

To connect AV input terminals

Connect side AV inputs

To access the unit connected to these jacks, press **TV/AV** button until **AV2** appears on the screen.

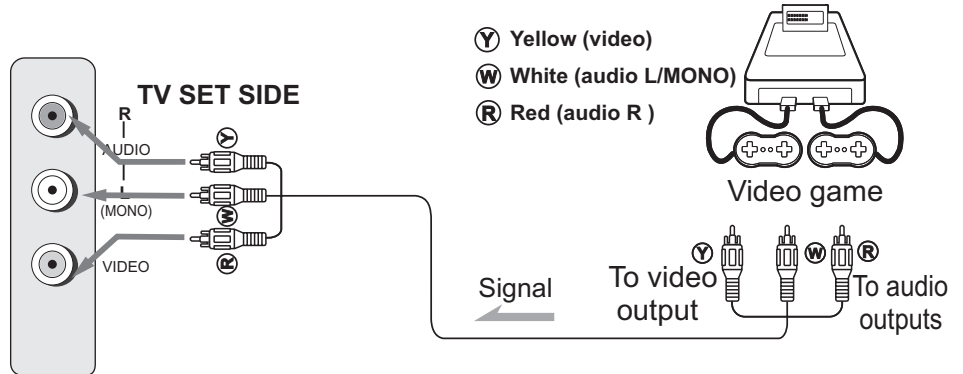

Connect rear AV inputs

If your video equipment has a S-VIDEO output terminal, connect it to the S-VIDEO input terminal on the unit. If not, connect it to the VIDEO terminal (RCA).

The S-VIDEO and AV1 use the same group of audio input terminals.

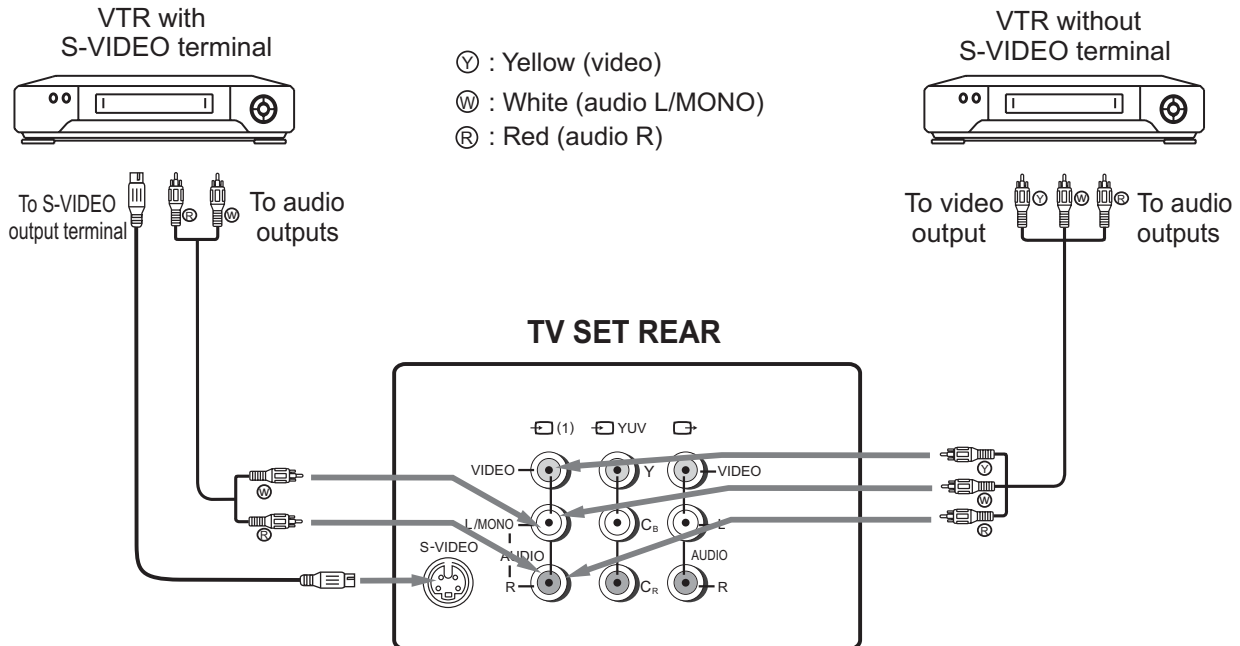

To access the unit connected to these jacks, press **TV/AV** button until **AV1** or **SVHS** appears on the screen.

External equipment connections

To connect DVD input terminals

The figure below shows how to connect the DVD input terminals of the TV set to the DVD Player, Laser Disk Player, etc.

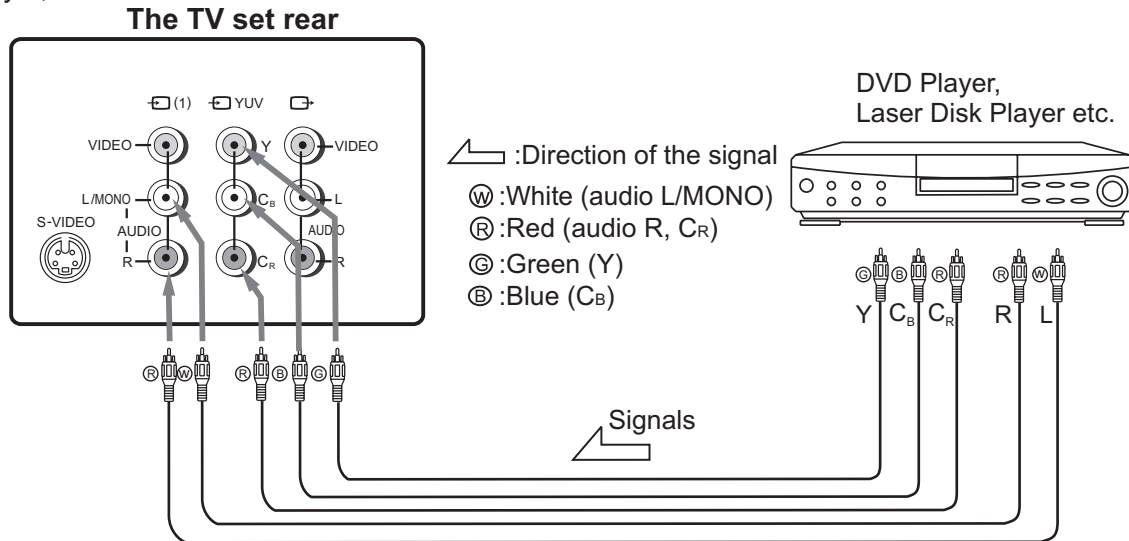

To access the unit connected to these jacks, press **TV/AV** button until **YUV** appears on the screen.

Notes:

- Both the C_R terminal and the audio R terminal are red for easy identification. Make sure they are correctly connected.
- DVD and AV1 use the same group of audio input terminals.

To connect the AV Outputs

You can connect an audio system to the AV output jacks on the TV set rear to enjoy high-quality sound from the audio system, or you can connect the AV output jacks to the VTR to record programming.

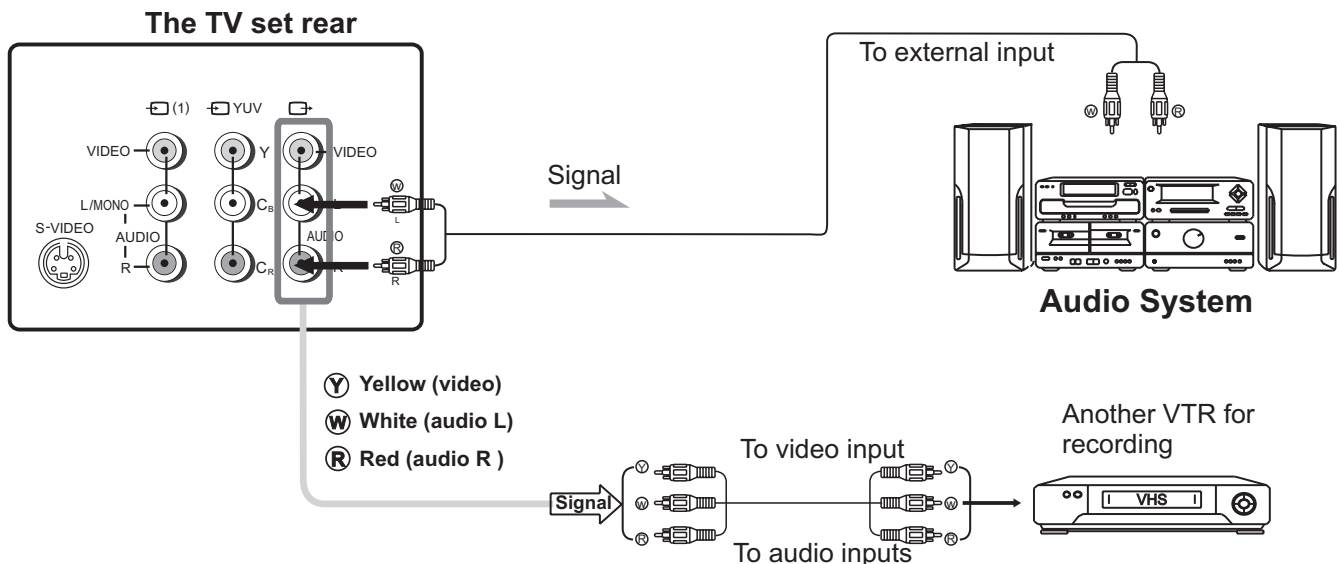

Power on/off

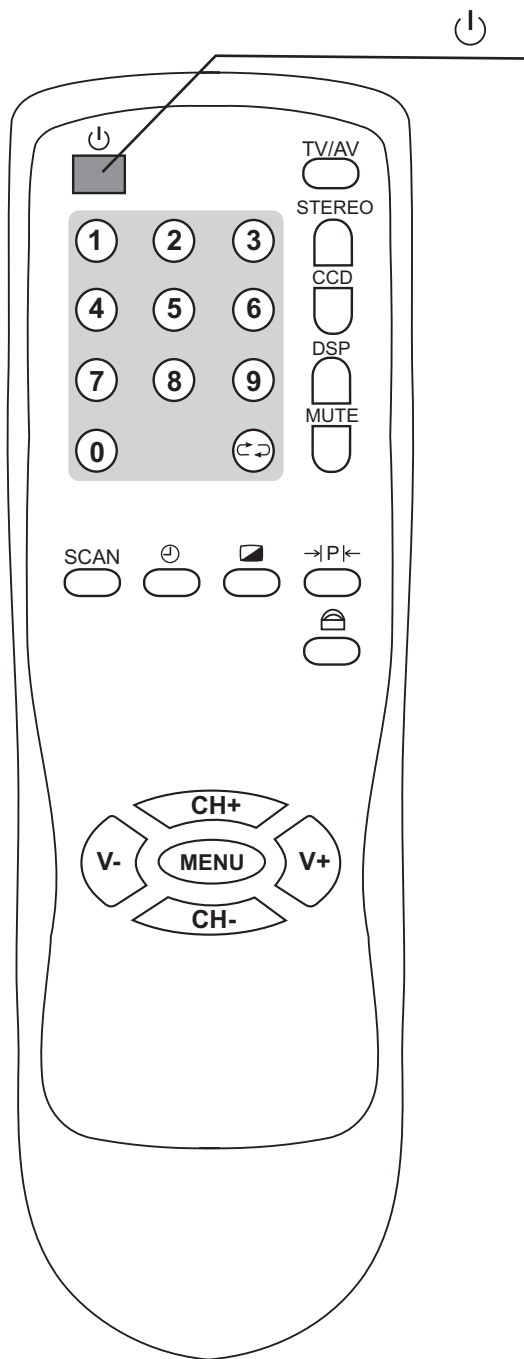

Turning on

- 1 Insert the AC plug (with the 2 blades) into a conveniently located AC outlet.

If no picture appears on the screen and the standby indicator lights up, the TV set is in STANDBY mode. Now please follow step 2.

- 2 In STANDBY mode, press Power (⏻) button on the remote controller or on the TV set and the TV set is turned on.

Turning off

- 1 If you want to turn off the TV set temporarily, press the Power (⏻) button.
- 2 Unplug the power cord from the AC outlet if you want to cut off the power completely.

Special indication:

Auto-Power-Off function: there are three kinds of Auto-Power-Off function:

1. If a vacant channel is tuned or TV broadcast for a day is finished, the TV will automatically turn off after a period of time.
2. Sleep-timer function
3. OFF timer function.

Selecting input signal

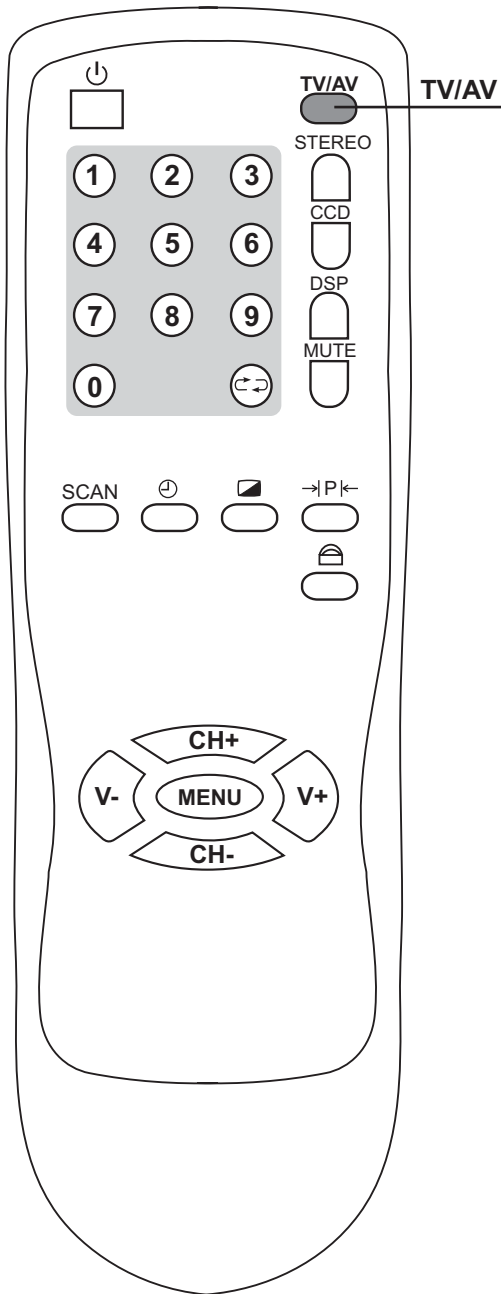

Watching AV program

This TV set provides AV input terminals for convenient connection to VCR, DVD or other video equipment.

1 To watch video program from AV inputs, press **TV/AV** button repeatedly until you see the

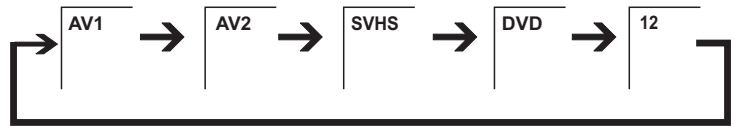

NOTE:

AV1: Select AV1 when viewing the signals from the video equipment connected to the AV1 IN terminals.

AV2: Select AV2 when viewing the signals from the video equipment connected to the AV 2 IN terminals.

SVHS: Select SVHS when viewing the signals from the video equipment connected to the S-VIDEO IN terminals.

DVD: Select DVD when viewing the signals from the video equipment connected to the DVD IN terminals.

Switching from AV to TV

When the TV set is in AV mode, you can do the following to switch back to TV mode.

Press TV/AV button repeatedly until the TV program appears.

Tuning in

TV/CATV selection

Before your TV can memorize the available channels, you must specify the type of signal source that is connected to the unit. (i.e., an antenna or cable system)

1 Press **MENU** repeatedly to display **Search** menu.

2 Press **CH-** or **CH+** to select **Signal Input**.

Search	
Signal Input	Air
Channel	28
Skip	Off
Auto Search	Press V+
Fine tune	0

3 Press **V-** or **V+** to select **Air** or **CATV(STD)** or **CATV(HRC)** or **CATV(IRC)**.

Select **Air** if using VHF/UHF antenna, select **CATV** if using Cable TV.

Select one of **CATV(STD)**/**CATV(HRC)**/**CATV(IRC)** according to your local area's cable system if using Cable TV.

4 Press **DSP** button to clear the menu screen.

Setting the channels into memory

This TV is equipped with a channel memory feature which allows channels to skip up or down to the next channel recorded in memory, omitting unwanted channels. Before selecting any channels, they must be programmed into the TV's memory.

1 Press **MENU** repeatedly to display **Search** menu.

Search	
Signal Input	Air
Channel	12
Skip	Off
Auto Search	Press V+
Fine tune	0

2 Press **CH-** or **CH+** to select **Auto Search**.

3 Press **V+** to start the search. The TV will begin memorizing all the channels available in your area.

Search	
Signal Input	Air
Channel	12
Skip	Off
Auto Search	Busy
Fine tune	0

4 Press **DSP** button to clear the menu screen.

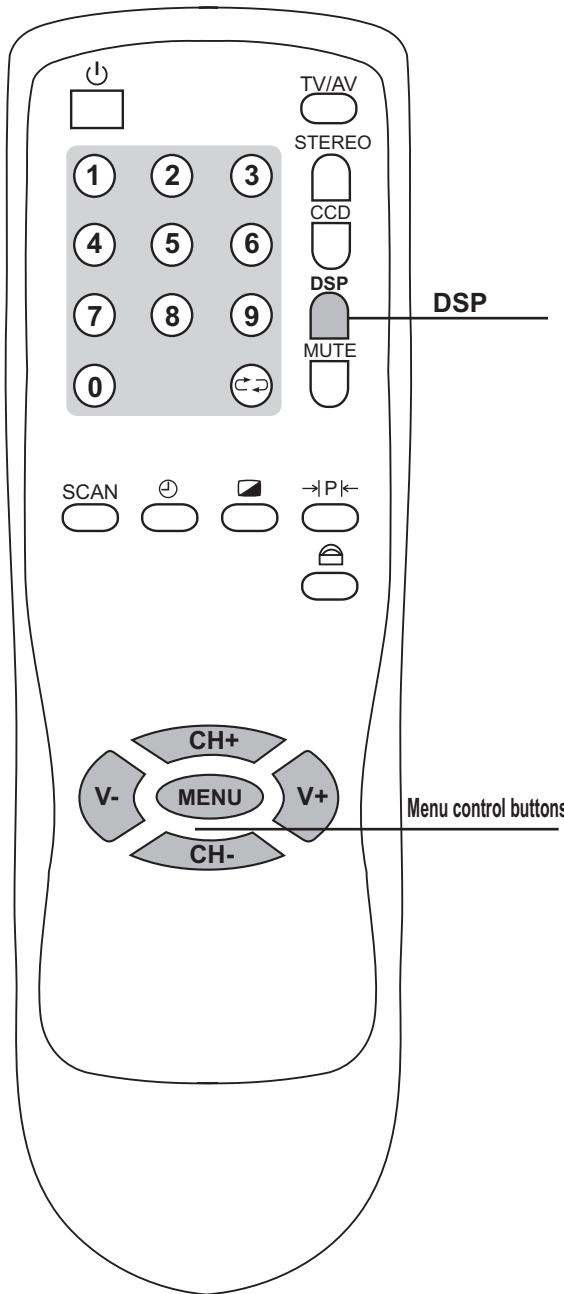

Tuning in

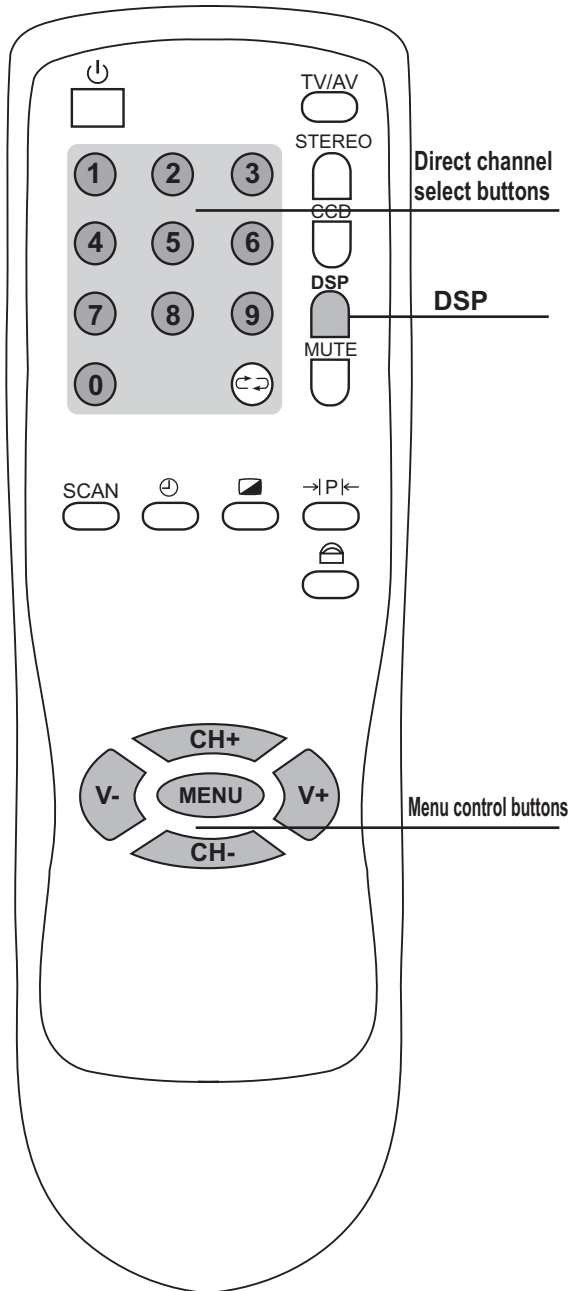

* To exit the menu, press **DSP** button or repeatedly press **MENU** button.

To skip unwanted channel

After presetting the channels, you can skip unwanted channels so that only the channels you want to watch are selected with Channel up/down buttons.

1 Select the unwanted channel with channel select buttons.

Or press **MENU** button repeatedly to display **Search** menu, press **CH-** or **CH+** to select **Channel** menu item, press **V-** or **V+** to select the unwanted channel.

Search	
Signal Input	Air
Channel	28
◆Skip	On
Auto Search	Press V+
Fine tune	0

2 Press **CH-** or **CH+** to select **Skip**, press **V-** or **V+** to select **Skip ON**.

Thus, after exiting the menu, the channel will then be skipped when you select programs with the Channel up/down button.

If you want to skip other unwanted channels, repeat steps above to change the channel number.

Note: you can select the skipped channel by pressing the direct channel select buttons.

To restore a skipped channel

Use direct channel select buttons (0-9) to select the channel you want to restore. Enter into **Search** menu, press **CH-** or **CH+** to select **Skip**, press **V-** or **V+** to select **Skip Off**.

Manual Fine Tuning

Fine tuning is not necessary under normal conditions. However, in some areas where there is interference, some adjustment may be necessary for better picture and sound. To fine tune a channel:

1 Select the channel you want to fine-tune.

2 Enter into **Search** menu, press **CH-** or **CH+** to select **Fine Tune**, then press and hold **V-** or **V+** to fine tune the channel until the best possible picture and sound are achieved.

Search	
Signal Input	Air
Channel	28
Skip	Off
Auto Search	Press V+
◆Fine tune	-5

(Press **V-** to fine-tune downward and **V+** to fine-tune upward. The **AFT** function will be set to **OFF** mode automatically)

Auto Fine Tuning (AFT)

If Fine Tuning makes the picture and sound of a channel poor, you can correct this by using AFT.

1 Enter into **Search** menu, press **CH-** to select **AFT**.

2 Press **V-** or **V+** to select **AFT On**.

Search	
Channel	28
Skip	Off
Auto Search	Press V+
Fine tune	-5
◆AFT	On

Channel selection

You can select desired TV programs by one of the following methods.

Use Direct Channel Select buttons

AIR Mode Direct Channel Selection

When the **Signal Input** menu option in **Search** menu is in the **Air** position, all channels can be selected by directly entering the channel number.

CATV Mode Direct Channel Selection

When the **Signal Input** menu option in **Search** menu is in the **CATV** position, channels can be selected as follows:

Method 1:

Directly enter the channel number and wait for a few moments.

Method 2:

1-9: Press "0" twice, then 1-9 as needed. For example, to select channel 2, press "002".

10-99: Press "0", then the remaining 2 digits. For example, to select channel 12, press "012".

100-125: Press the 3 digits in order. For example, to select channel 120, press "120".

Use Channel up/down buttons

Press **CH+** button, the channel number increases;
Press **CH-** button, the channel number decreases.

Use previous channel button

Press $\leftarrow \rightarrow$ button to switch between the current channel and the previous one.

Notes:

Use DSP button to know the current channel number

Press **DSP** button to display the current state of the TV. If the TV is in program viewing mode, it will display the current channel number, sound mode and remaining sleep time (if set).

12 ST SAP

Sleep 22

To scan programs

Press **SCAN** button and the TV will scan the channels from the current channel to higher channels one by one. Every program will be displayed for about one second and then the TV will continue scanning.

Press **SCAN** button again and the TV will stop at the displayed program.

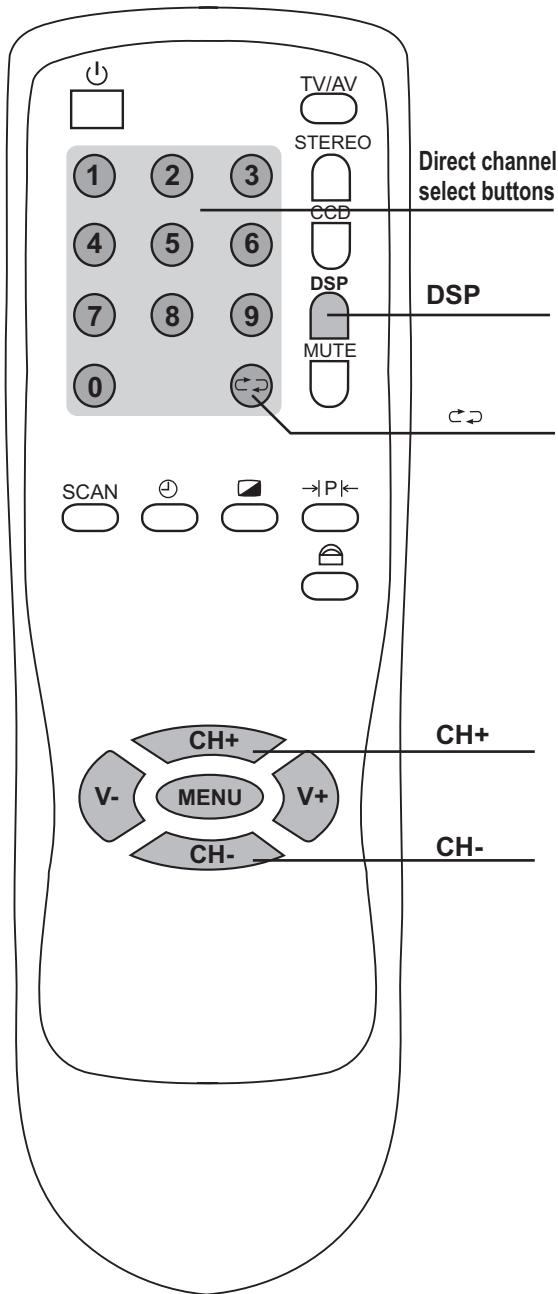

Picture adjustment

To select the picture mode

You can select the picture quality instantly among three preset modes and one user-set mode.

Press \rightarrow P \leftarrow button to select the desired picture quality. **Standard**, **Dynamic**, **Mild** and **User** (user-set) can be selected cyclically.

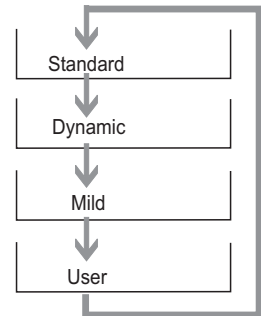

Mode	Picture quality
Standard	Display normal pictures
Dynamic	Display dynamic pictures
Mild	Display soft pictures
User	The picture quality you set

Picture adjustment

- 1 Press **MENU** button to display the **Picture** menu.
- 2 Press **CH+** or **CH-** to select item.
- 3 Press **V+** or **V-** to adjust the level.

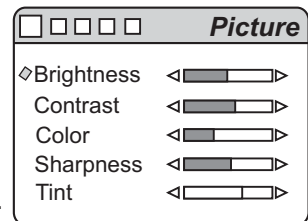

Or you can also make use of \blacksquare button to adjust picture. Every time you press \blacksquare button, one picture adjustment menu bar will appear. Then make use of **V+** or **V-** button to adjust the level.

Item	V-	V+
Brightness	darker	lighter
Contrast	weaker	stronger
Color	paler	deeper
Sharpness	softer	sharper
*Tint	purplish	greenish

Notes:

The adjusted level is stored in the User position.

* To exit the menu, press **DSP** button or repeatedly press **MENU** button.

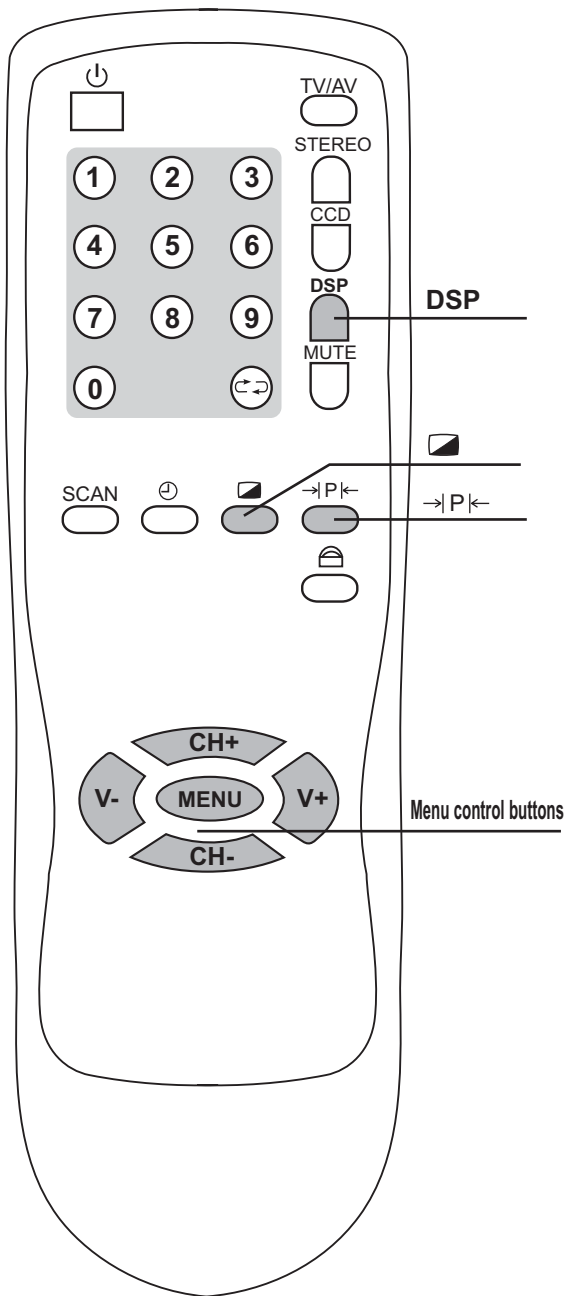

Sound controls

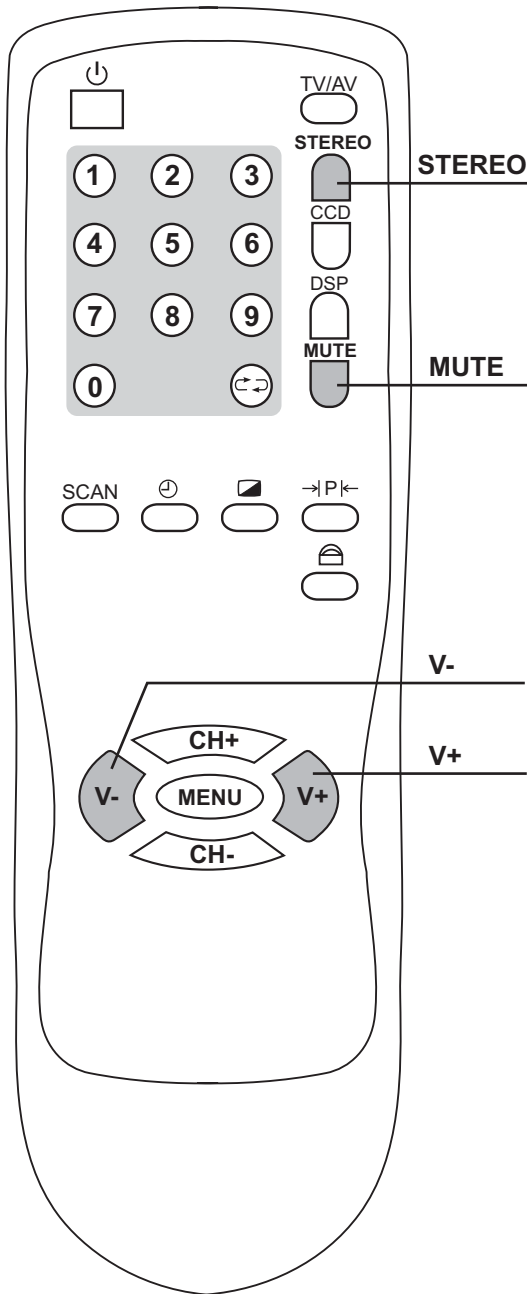

Adjusting volume

1 Use Volume up/down button

Press **V-** button, the volume decreases;

Press **V+** button, the volume increases.

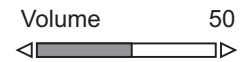

2 Make use of Sound menu to adjust volume

Press **MENU** twice to display **Sound** menu, then make use of **V+/-** button to adjust the level.

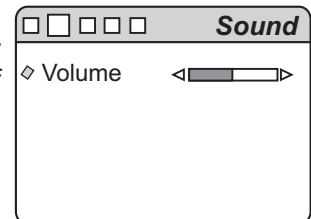

3 Use MUTE button.

If you want to mute the sound, press **MUTE** button on the remote.

To resume the sound, press the button again.

Mute

To select MTS (Multi-channel TV Sound)(option)

Mono ↔ Stereo (If the program is **STEREO**)

Mono ↔ SAP (If the program is **SAP**)

Mono → Stereo → SAP (If the program is **STEREO & SAP**)



SAP: second audio program

STEREO: stereo audio

MONO: monophonic audio

Note: **MTS stereo** function is an optional function. It is only available on certain versions.

Timer setting

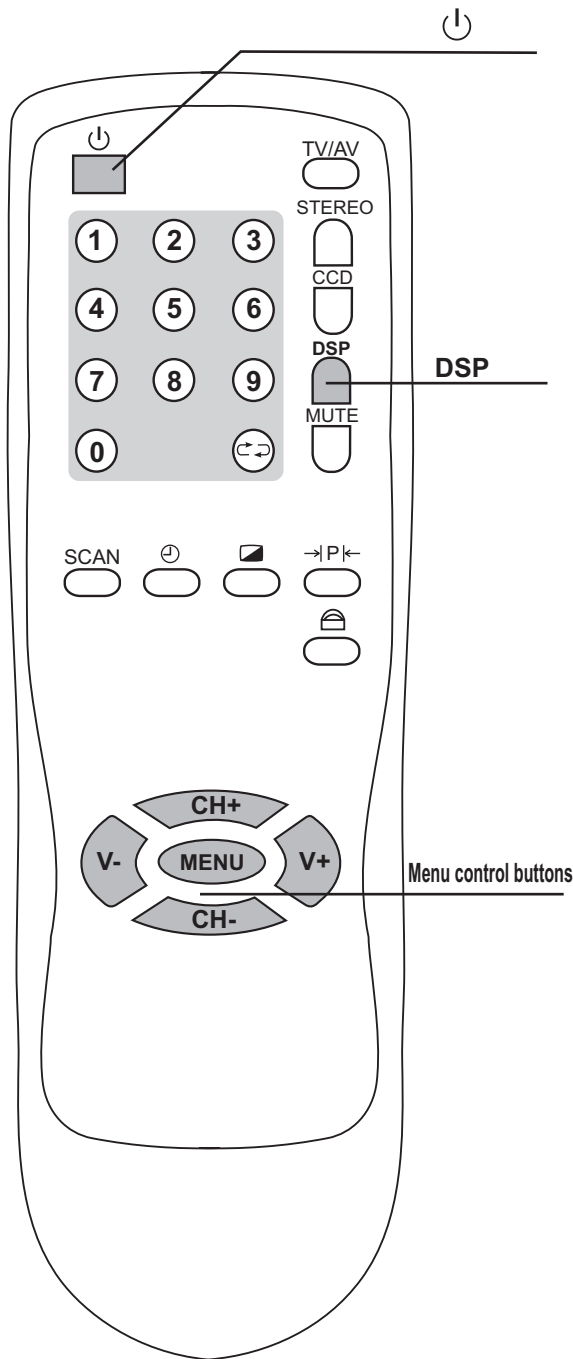

Setting clock time

This function sets the current time for the TV.

- 1 Press **MENU** repeatedly to display the **Timer** menu.
- 2 Press **CH-** or **CH+** to select **Clock**.
- 3 Press **V-** to set the hour (0-23), press **V+** to set the minute (00-59).

Timer	
◇ Clock	10:05
On Time	--:--
On Program	32
Off Time	--:--
Repeat	Once

Note:

Before using the ON timer and OFF timer, set the Clock item first.

Setting ON timer/ON program

With the ON timer, the TV will automatically turn on to a preset channel at a preset time.

- 1 In **Timer** menu, press **CH-** or **CH+** to select **On Time**. Press **V-** to set the hour (0-23), press **V+** to set the minute (00-59).
- 2 Press **CH-** to select **On Program**. Press **V-** or **V+** to set the TV ON program number.
- 3 Press **CH-** to select **Repeat**. Press **V-** or **V+** to select **Once** or **Everyday**.

Timer	
Clock	10:07
◇ On Time	18:00
On Program	32
Off Time	--:--
Repeat	Once

Timer	
Clock	10:07
On Time	18:00
◇ On Program	32
Off Time	--:--
Repeat	Once

Timer	
Clock	10:07
On Time	18:00
On Program	32
Off Time	--:--
◇ Repeat	Once

- 4 Press **⏻** button to switch the TV to standby mode.

At the preset time, the TV will turn on automatically to the preset channel.

If you set the **Repeat** item to **Once**, this function operates only once; If set to **Everyday**, this function operates everyday.

Timer setting

Setting OFF timer

With the OFF timer, the TV will automatically switch to standby mode at a preset time.

- 1 In **Timer** menu, press **CH-** or **CH+** to select **Off Time**. Press **V-** to set the hour (0-23), press **V+** to set the minute (00-59).

Timer	
Clock	10:08
On Time	18:00
On Program	32
Off Time	13:30
Repeat	Once

- 2 Press **CH-** to select **Repeat**. Press **V-** or **V+** to select **Once** or **Everyday**.

Once the preset time has elapsed, the TV will automatically go into standby mode.

If you set the **Repeat** item to **Once**, this function operates only once; If set to **Everyday**, this function operates everyday.

Setting sleep timer

Making use of the Sleep timer function allows you to have the set automatically turn off after a preset time, and bring the TV to standby mode.

With every press of \odot button the sleep time changes in the sequence of 120 \rightarrow 90 \rightarrow 60 \rightarrow 50 \rightarrow 40 \rightarrow 30 \rightarrow 20 \rightarrow 15 \rightarrow 10 \rightarrow 5 \rightarrow 0 \rightarrow 120 (minutes) ---.

For example, if you would like the TV to auto turn off in 60 minutes, you can press \odot button repeatedly until the screen displays the desired amount of time. If you want to cancel the sleep timer, you can press \odot button repeatedly until 0 displays on the screen.

Sleep 60

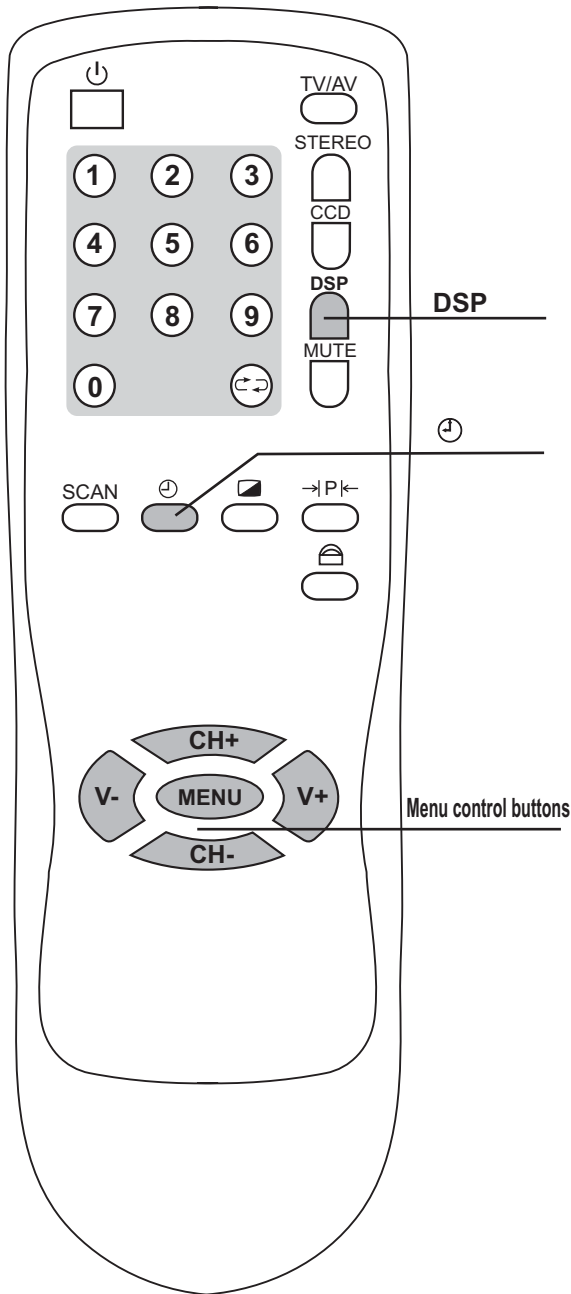

* To exit the menu, press **DSP** button or repeatedly press **MENU** button.

System Settings

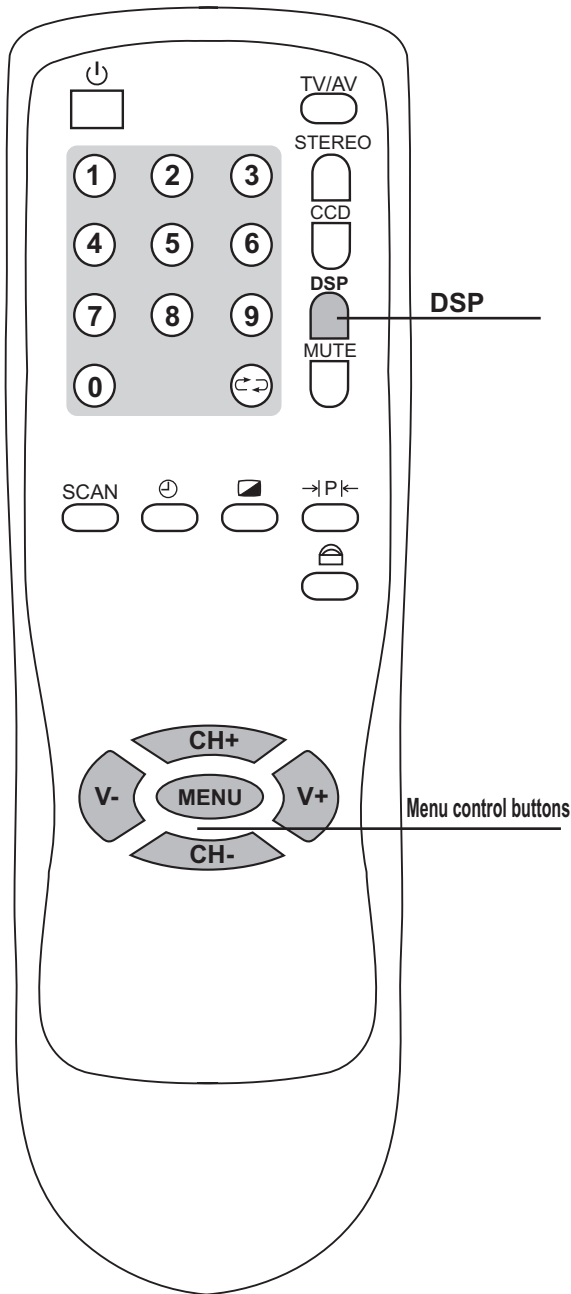

To select OSD language

There are several OSD (on-screen display) languages to choose from.

1 Press **MENU** repeatedly to display **Settings** menu.

Settings	
◇ Language	English
Blue Screen	On
Picture Enhance	Off
Caption Mode	CC1
Game	

2 Press **CH+/-** to select **Language**.

3 Press **V+** or **V-** to select a proper OSD language.

Setting Blue Screen

1 Enter into **Settings** menu.

Settings	
Language	English
◇ Blue Screen	On
Picture Enhance	Off
Caption Mode	CC1
Game	

2 Press **CH-** or **CH+** to select **Blue Screen**.

3 Press **V+** or **V-** to turn on/off blue screen.

If the Blue Screen function is turned on, the TV will display a blue screen when there is no input signal.

Picture Enhance setup

1 Enter into **Settings** menu.

Settings	
Language	English
Blue Screen	On
◇ Picture Enhance	On
Caption Mode	CC1
Game	

2 Press **CH-** or **CH+** to select **Picture Enhance**.

3 Press **V+** or **V-** to turn on/off **Picture Enhance**.

Turning on Picture Enhance can enhance the picture quality.

* To exit the menu, press **DSP** button or repeatedly press **MENU** button.

Closed Captions

The unit decodes and displays the closed captions that are broadcast with certain TV shows. These captions are usually subtitles for the hearing impaired or foreign language translations. All VCRs record the closed caption signal from television programs, so home-recorded video tapes also provide closed captions. Most prerecorded commercial video tapes provide closed captions as well. Check for the closed caption symbol in your television schedule and on the tape's packaging: .

Note:

Not all the programs and videos will offer closed captioning.

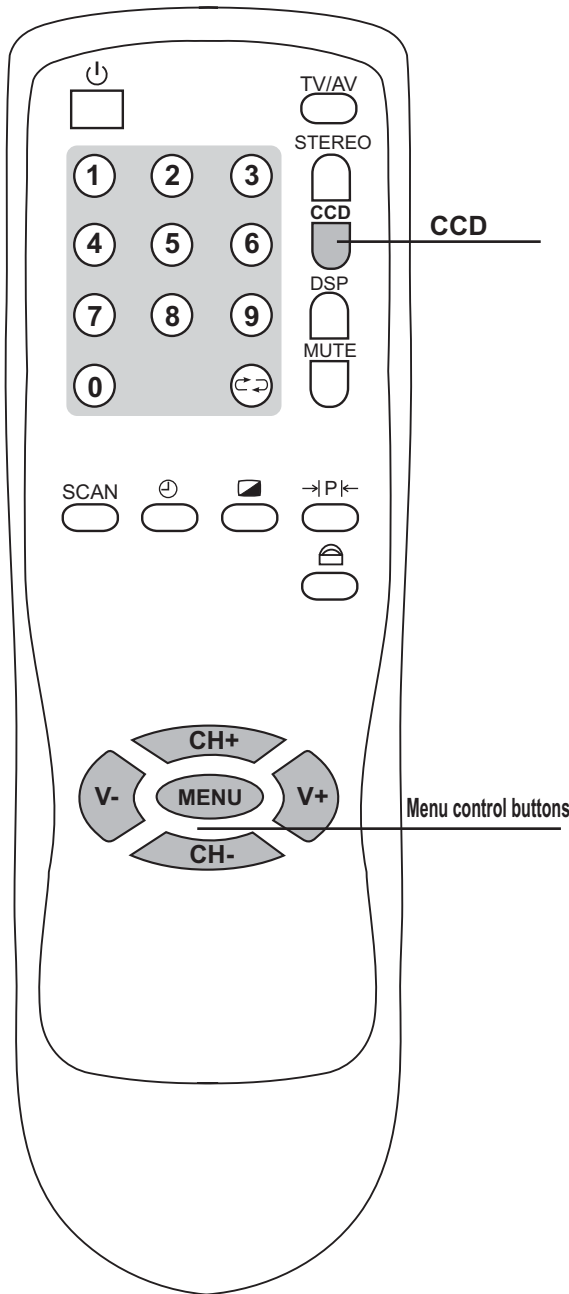

Turning Closed Caption On or Off

Press **CCD** button on the remote control to turn on/off Closed Caption.



Setting Closed Caption

1 Press **MENU** repeatedly to display **Settings** menu.

Settings	
Language	English
Blue Screen	On
Picture Enhance	Off
◆ Caption Mode	CC1
Game	

2 Press **CH+/-** to select **Caption Mode**.

3 Press **V+/-** to select Closed Caption setting.

You may select between CC1, CC2, CC3, CC4, T1, T2, T3 and T4.

The Closed Caption broadcasts can be viewed in two modes: CAPTION and TEXT. For each mode, four channels are available.

The [CAPTION] mode shows subtitles of dialogues and commentaries of TV dramas and news programs while allowing a clear view of the picture.

The [TEXT] mode displays various information over the picture (such as TV program schedule, weather forecast, etc.) that is independent of the TV programs.

* To exit the menu, press **DSP** button or repeatedly press **MENU** button.

Setting Parental Control

Parental Control enables parents to prevent their children from watching inappropriate material on TV. Parental Control reads the ratings for programming (except for news, sports, unedited movies on premium cable and Emergency System signals) and denies access to programming if the program's rating meets the limitations you select. In this case, the program will be blocked.

To use the Parental Control function, you first need to set your password.

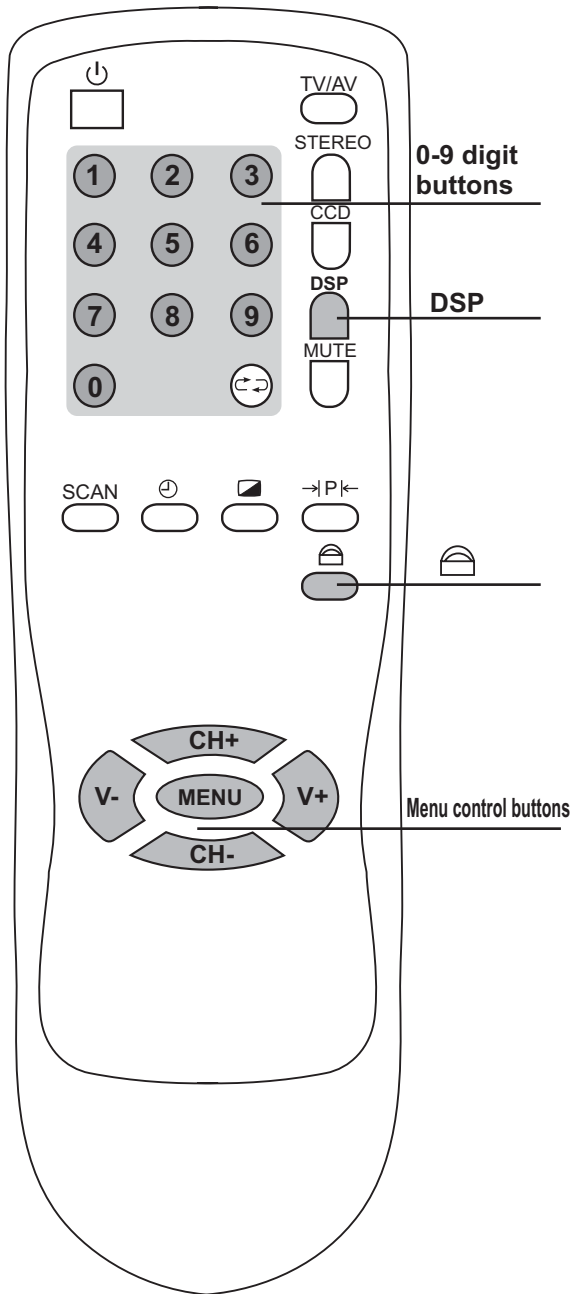

To set a password

- 1 Press to display **Parental Control** menu. Now a password is required to input.

Parental Control
Password: ----- U.S. TV Rating MPAA Rating CANADA English CANADA French Change Password

- 2 Press digit buttons to input the password (six-digit, the default password is 000000 and you should change it) to enter into **Parental Control** menu.

Parental Control
Password: ***** U.S. TV Rating MPAA Rating CANADA English CANADA French Change Password

- 3 Press **CH-** to select **Change Password** item.
Press **V+** or **V-** button to enter into the sub-menu.

Parental Control
Password: ***** U.S. TV Rating MPAA Rating CANADA English CANADA French Change Password

- 4 Enter a new password and confirm again.
Now the password has been modified successfully.

Change Password
Password: ***** Confirm: -----

* To return to upper-level menu, press button.

* To clear the menu screen, press **DSP** button.

If you forget the password, you may use the master password to enter into Parental Control menu. The master password is 410000. Make sure children do not know any passwords.

Setting Parental Control

U.S. TV Rating Set-up

TV Parental Guidelines may have one or more letters added to the basic rating to let parents know when a show contains higher levels of violence, sex, adult language or suggestive dialogue.

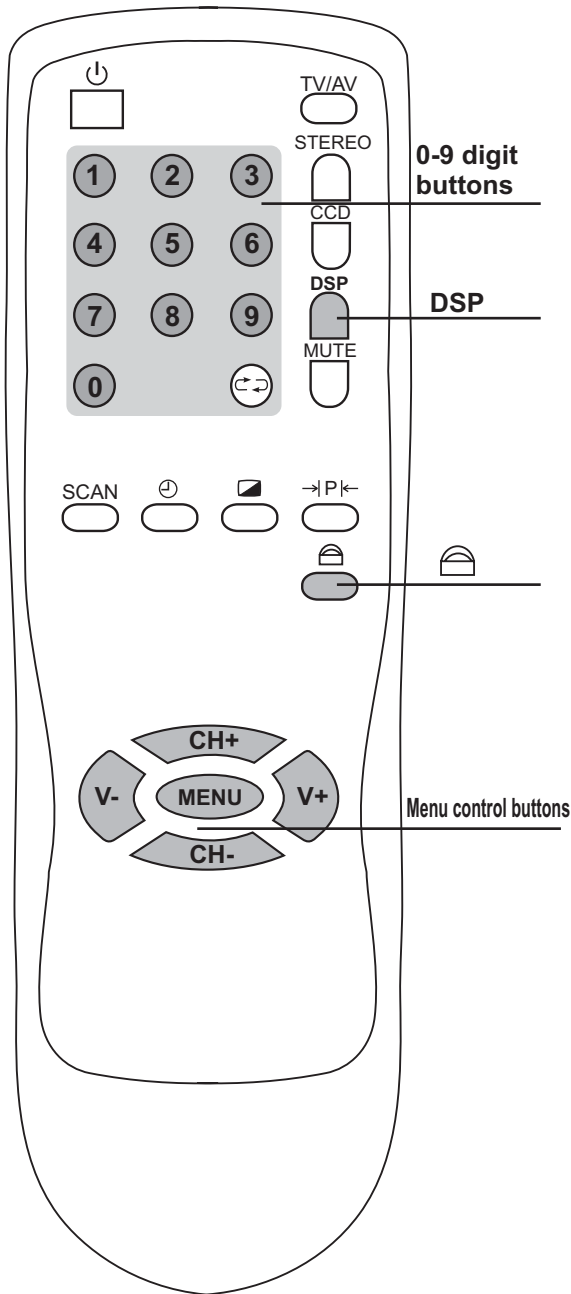

1 Press button and then input the correct password to enter into **Parental Control** menu.

Parental Control	
Password:	*****
U.S. TV Rating	
MPAA Rating	
CANADA English	
CANADA French	
Change Password	

2 Press **CH-** or **CH+** button to select **U.S. TV Rating** item. Press **V+** or **V-** button to enter into the sub-menu.

U.S. TV Rating							
Age	Status	FV	V	S	L	D	
TV-Y	View	-	-	-	-	-	-
TV-Y7	View	V	-	-	-	-	-
TV-G	View	-	-	-	-	-	-
TV-PG	View	-	V	V	V	V	V
TV-14	View	-	V	V	V	V	V
TV-MA	Block	-	B	B	B	B	-

3 In **U.S. TV Rating** sub-menu, use **CH+/-** to select the desired rating, use **MENU** to toggle between **Block** and **View**.

- * Y and Above (all children) (individual content categories do not apply)
- * Y7 (7 years and up)
- * G and above (general audience) (individual categories do not apply)
- * PG and Above (parental guidance suggested)
- * 14 and above (14 years and up)
- * MA (mature audience)

You can also block the criteria for each level for FV, V, S, L, D. The steps are below:

Select the desired rating with **CH+/-**, press **MENU** to select **View**, then make use of **V+/-** to select the desired criteria, then press **MENU** to either block the rating ("**B**" will appear) or unblock ("**V**" will appear).

- * FV: fantasy violence (applies only to TV-Y7)
- * V: violence (applies to TV-PG and above, TV-14 and Above, TV-MA)
- * S: sexual situations (applies to TV-PG and above, TV-14 and Above, TV-MA)
- * L: adult language (applies to TV-PG and above, TV-14 and Above, TV-MA)
- * D: sexual dialogue (applies to TV-PG and Above, TV-14)

4 To return to upper-level menu, press button. To clear the menu screen, press **DSP** button.

Setting Parental Control

Movie Rating Set-up

Rating guidelines are provided by broadcast stations. Most television programs and television movies can be blocked by TV Rating and/or Individual Categories. Movies that have been shown at the theaters or direct-to-video movies use the Movie Rating System (MPAA) only.

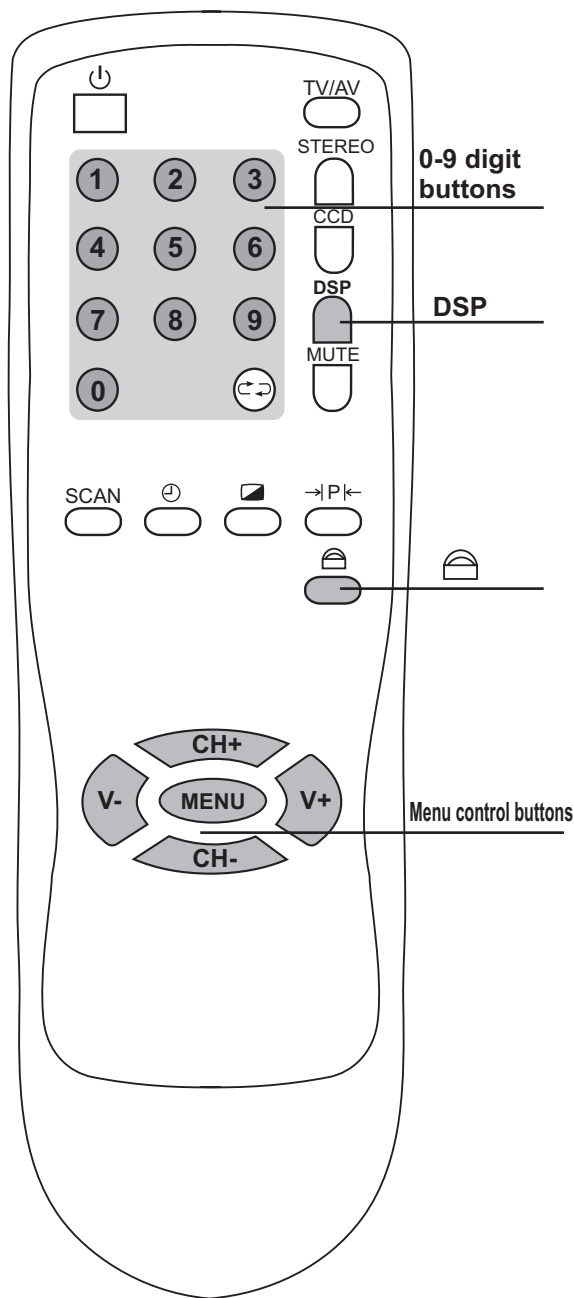

1 Press button and then input the correct password to enter into **Parental Control** menu.

2 Press **CH-** or **CH+** button to select **MPAA Rating** item. Press **V+** or **V-** button to enter into the sub-menu.

Parental Control

Password: * * * * *
 U.S. TV Rating
MPAA Rating
 CANADA English
 CANADA French
 Change Password

3 In **MPAA Rating** sub-menu, use **CH+/-** to select the desired rating, use **V+/-** to toggle between **Block** and **View**.

MPAA

G	View
PG	View
PG-13	View
R	Block
NC-17	Block
X	Block

Movie Ratings:

- * G and Above (general audience)
- * PG and Above (parental guidance suggested)
- * PG-13 and Above (13 years and up)
- * R and Above (restricted)
- * NC-17 and Above (18 years and up)
- * X (adult)

4 To return to upper-level menu, press button. To clear the menu screen, press **DSP** button.

Setting Parental Control

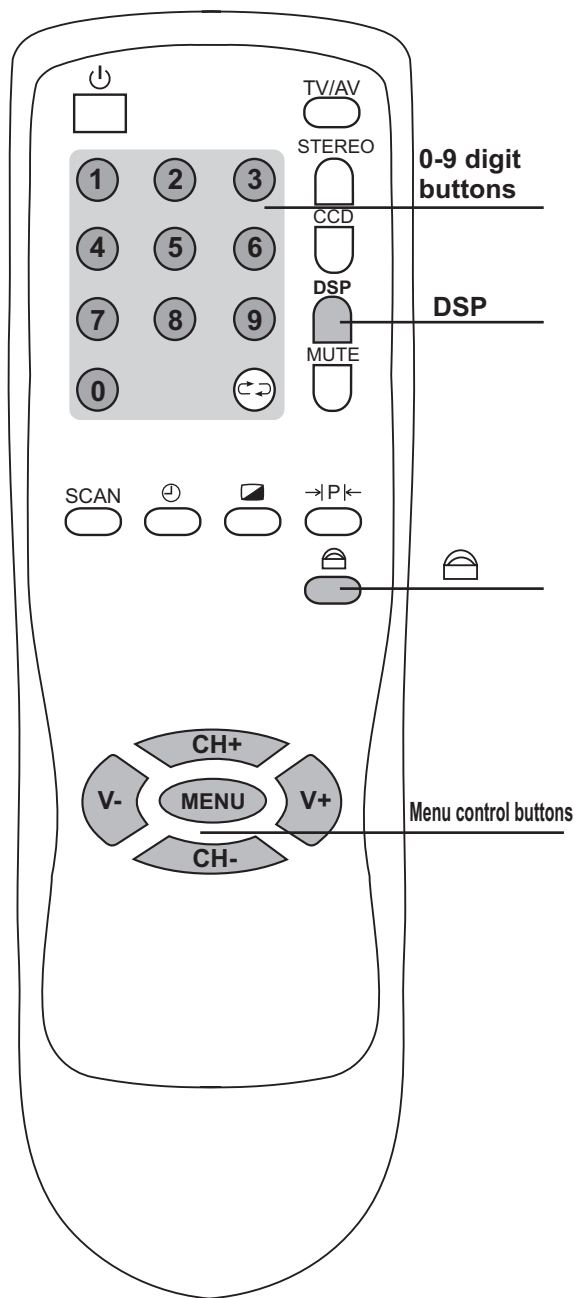

CANADA English Rating Set-up

- 1 Enter into **Parental Control** menu, press **CH+** or **CH+** button to select **CANADA English** menu item. Press **V+** or **V-** button to enter into the sub-menu.

Parental Control

Password: * * * * *
 U.S. TV Rating
 MPAA Rating
CANADA English
 CANADA French
 Change Password

- 2 In **CANADA English** sub-menu, use **CH+/-** to select the desired rating, use **V+/-** to toggle between **Block** and **View**.

CANADA English

E	View
C	View
C8+	View
G	Block
PG	Block
14+	Block
18+	Block

Canadian English Language Ratings:

- * E: Exempt.
- * C: Children.
- * C8+: Children 8 years and older.
- * G: General programming, suitable for all audiences.
- * PG: Parental guidance.
- * 14+: Viewers 14 years and older.
- * 18+: Adult programming.

CANADA French Rating Set-up

- 1 Enter into **Parental Control** menu, press **CH-** or **CH+** button to select **CANADA French** menu item. Press **V+** or **V-** button to enter into the sub-menu.

Parental Control

Password: * * * * *
 U.S. TV Rating
 MPAA Rating
 CANADA English
CANADA French
 Change Password

- 2 In **CANADA French** sub-menu, use **CH+/-** to select the desired rating, use **V+/-** to toggle between **Block** and **View**.

CANADA French

E	View
G	View
8 ans+	View
13 ans+	Block
16 ans+	Block
18 ans+	Block

Canadian French Language Ratings:

- * E: Exempt.
- * G: Children.
- * 8 ans+: Children 8 years and older.
- * 13 ans+: Children 13 years and older.
- * 16 ans+: Viewers 16 years and older.
- * 18 ans+: Adult programming.

To return to upper-level menu, press button.
 To clear the menu screen, press **DSP** button.

Troubleshooting Guide

Before calling service personnel, please check the following chart for a possible cause to the trouble you are experiencing.

	SYMPTOM	POSSIBLE CAUSE	POSSIBLE SOLUTION
Power	No power	The AC power cord is not connected.	Connect the AC power cord to the AC outlet
	TV broadcast reception	Poor or no picture.	TV station experiencing problems.
Picture control is not adjusted.			Check picture control adjustments.
Possible local interference.			Check for source of reception disturbance
Antenna/CATV connector is not connected.			Check CATV connection or VHF/UHF ant.
Picture wobbles or drifts.		TV station experiencing problems.	Try another channel.
		Cable TV channel is scrambled.	A Cable box needs to be used (if desired).
		Possible local interference.	Check for source of reception disturbance
No CATV reception.		CATV connected or not connected.	Check all CATV connections.
		TV/CATV set to TV.	Set TV/CATV to CATV
		Cable TV service interrupted.	Contact your Cable TV company.
No reception above CH13.		TV/CATV set to TV.	Set TV/CATV to CATV.
Poor or no sound.		TV station experiencing problems.	Try another channel.
	MUTE button is pressed.	Press MUTE button again.	
	Possible local interference.	Check for source of reception disturbance.	
	Antenna/CATV connector is not connected.	Check CATV connection or VHF/UHF ant.	
	Volume is set to minimum.	Increase volume.	
TV Shuts off.	Sleep Timer is set.	Set Sleep Timer to "0".	
	Off Timer is set.	Clear Off Timer.	
Closed Captioning not working.	TV Signal is weak.	Check CATV or VHF/UHF antenna.	
	TV station experiencing problems or program tuned is not closed captioned.	Try another channel.	
	Closed Captioning not turned on.	Press the CCD button.	
Remote Control	Remote control does not operate.	The remote control is not aimed at the sensor.	Aim the remote control at the Remote sensor.
		Distance is too far or too much light in the room.	Operate within 23 feet or reduce the light in the room.
		There is an obstacle in the path of the beam.	Clear the path of the beam.
		The batteries are weak.	Replace the batteries.
		The batteries are not inserted correctly.	Insert correctly.
V-CHIP	Parental Control not Working properly.	News or sports event being broadcast.	Parental Control does not work with News or sporting events.
		Ratings not set.	Set ratings as desired.

Troubleshooting Guide

Reception disturbances

Most types of television interference can be remedied by adjusting the height and position of the VHF/UHF antenna. Outdoor antennas are recommended for best results if not using cable. The most common types of television interference are shown below. If one of these symptoms appear when the TV is connected to a Cable TV system, the disturbance may be caused by the local cable company broadcast.

IGNITION:

Black spots or horizontal streaks may appear, picture may flutter or drift. Usually caused by interference from automobile ignition systems, neon lamps, electric drills and other electric appliances.



GHOSTS:

Ghosts are caused by the television signal following two paths. One is the direct path and the other is reflected from tall buildings, hills or other objects. Changing the direction or position of the antenna may improve the reception.



SNOW:

If your receiver is located in the fringe area of a television station where the signal is weak, your picture may be marred by the appearance of small dots. When the signal is extremely weak, it maybe necessary to install an external antenna to improve the picture.



RADIO FREQUENCY INTERFERENCE:

This interference produces moving ripples or diagonal streaks, and in some cases, causes loss of contrast in the picture.



PICTURE SIZE VARIATION:

A slight picture size variation is quite normal when you adjust the CONTRAST or BRIGHTNESS setting.

CARE AND MAINTENANCE

To prevent fire or shock hazard, disconnect your TV from the AC power source when cleaning. The finish on the cabinet may be cleaned with a dust cloth and cared for as with furniture. Use caution when cleaning and wiping the plastic parts. Mild soap and a soft, damp cloth may be used.

Specifications

Power Supply	AC 120V 60Hz
Power Consumption	140W (Max.)
Dimensions(inch)	27.2(W) x 20.6(H) x 19.2(D)
Weight(lbs)	80
CRT(inch)	24"
Sound output	4W+4W
Color System	NTSC-M
Accessory	Remote control x 1
Receiving channel:	
VHF	2-13
UHF	14-69
CATV	2-69, (A-6)-(A-1), A-W, (W+1)-(W+28)
Total	181 channels

Note: Design and specifications are subject to change without notice.

For service, support and warranty information, visit www.pwwservice.com or call 1-866-396-6322.

"Polaroid" is a registered trademark of Polaroid Corporation of Waltham, MA USA and licensed for use on the TTM-2401 to Petters Consumer Brands, LLC.

Free Manuals Download Website

<http://myh66.com>

<http://usermanuals.us>

<http://www.somanuals.com>

<http://www.4manuals.cc>

<http://www.manual-lib.com>

<http://www.404manual.com>

<http://www.luxmanual.com>

<http://aubethermostatmanual.com>

Golf course search by state

<http://golfingnear.com>

Email search by domain

<http://emailbydomain.com>

Auto manuals search

<http://auto.somanuals.com>

TV manuals search

<http://tv.somanuals.com>