

20" TV/DVD/VCR Combo TBX-2000AF

Instruction Manual



 **Polaroid**

WARNING

To reduce the risk of fire or electric shock, do not expose this product to rain or moisture.

The apparatus shall not be exposed to dripping or splashing and that no objects filled with liquids, such as vases, shall be placed on the apparatus.



Caution: To reduce the risk of electric shock, do not remove cover (or back). No user serviceable parts inside. Refer servicing to qualified service personnel.

 This symbol indicates "dangerous voltage" inside the product that presents a risk of electric shock or personal injury.

 This symbol indicates important instructions accompanying the product.

Caution: To prevent electric shock, match wide blade of plug to wide slot, fully insert.

Attention: Pour é viter les chocs é lectriques, introduire la lame la plus large de la fiche dans la borne correspondante de la prise et pousser jusqu' au fond.

USE OF CONTROLS OR ADJUSTMENTS OR PERFORMANCE OF PROCEDURES OTHER THAN THOSE SPECIFIED HEREIN MAY RESULT IN HAZARDOUS RADIATION EXPOSURE. **DO NOT STARE INTO BEAM.**

The unit employs a Laser System. To prevent direct exposure to the laser beam, do not try to open the enclosure. Visible laser radiation when open and interlocks defeated.

Refer to the identification/rating label located on the back panel of your product for its proper operating voltage.

Caution: Using video games or any external accessory with fixed images for extended periods of time can cause them to be permanently imprinted on the picture tube (or projection TV picture tubes). ALSO, some network/program logos, phone numbers, etc. may cause similar damage. This damage is not covered by your warranty.

Cable TV Installer

This reminder is provided to call your attention to Article 820-40 of the National Electrical Code (Section 54 of the Canadian Electrical Code, Part 1) which provides guidelines for proper grounding and, in particular, specifies that the cable ground shall be connected to the grounding system of the building as close to the point of cable entry as practical.

Customer Record

You will find the model number and chassis number of your unit on the back of your unit. Record these numbers in the spaces provided below. Refer to them whenever you call customer service or your dealer regarding this product.

Model Number: _____ Chassis Number: _____

PACKING LIST	
<u>Parts</u>	<u>QTY</u>
TV/DVD/VCR Combo	1
Remote Control	1
Operation Manual	1
AAA Alkaline Batteries	2

IMPORTANT SAFETY INSTRUCTIONS

1. Read these instructions.
2. Keep these instructions.
3. Heed all warnings.
4. Follow all instructions.
5. Do not use this apparatus near water.
6. Clean only with dry cloth.
7. Do not block any ventilation openings. Install in accordance with the manufacturer's instructions.
8. Do not install near any heat sources such as radiators, heat registers, stoves, or other apparatus (including amplifiers) that produce heat.
9. Do not defeat the safety purpose of the polarized or grounding-type plug. A polarized plug has two blades with one wider than the other. A grounding type plug has two blades and a third grounding prong. The wide blade or third prong is provided for your safety. If the provided plug does not fit into your outlet, consult an electrician for replacement of the obsolete outlet.
10. Protect the power cord from being walked on or pinched particularly at plugs, convenience receptacles, and the point where they exit from the apparatus.
11. Only use attachments/accessories specified by the manufacturer.
12. Use only the cart, stand, tripod, bracket, or table specified by the manufacturer, or sold with the apparatus. When a cart is used, use caution when moving the cart/apparatus combination to avoid injury from tip-over.
13. Unplug this apparatus during lightning storms or when unused for long periods of time.
14. Refer all servicing to qualified service personnel. Servicing is required when the apparatus has been damaged in any way, such as power-supply cord or plug is damaged, liquid has been spilled or objects have fallen into the apparatus, the apparatus has been exposed to rain or moisture, does not operate normally, or has been dropped.
15. **Warning - This unit should only be serviced by an authorized and properly trained technician. Opening the cover or other attempts by the user to service this unit may result in serious injury or death from electrical shock, and may increase the risk of fire.**



FCC Warning

Class B Computing Device

Information to User

This equipment has been tested and found to comply with the limits for a Class B Digital Device pursuant to part 15 of FCC Rules. These limits are designed to provide reasonable protection against harmful interference in a residential installation. This equipment generates, uses, and can radiate radio frequency energy and, if not installed and used in accordance with the instructions, may cause harmful interference to radio communications. However, there is no guarantee that interference will not occur in a particular installation. If this equipment receives interference while off and on, the user is encouraged to try to correct the interference by one or more of the following measures:

- 1) Reorient or relocate the receiving antenna.
- 2) Increase the separation between the equipment and unit.
- 3) Connect the equipment into an outlet on a circuit different from that to which the unit is connected.
- 4) Consult the dealer or an experienced radio/TV technician for help and for additional suggestions.

The user may find the following booklet prepared by the Federal Communications Commission helpful: "How to Identify and Resolve Radio - TV Interference Problems". This booklet is available from the US Government Printing Office, Washington, D.C. 20402, Stock No. 004-000-00345-4.

FCC Warning

The user is cautioned that changes or modifications not expressly approved by the manufacturer could void the user's authority to operate the equipment.

NOTE: In order for an installation of the product to maintain compliance with the limits for a Class B Device, shielded cables must be used.



WARNING:
THE REGION CODE FOR THE UNIT IS 1.

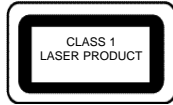

Since it is very usual for DVD movies to be released at different times in different regions of the world, all players have region codes and disks can have an optional region code. If you load a disk of a different region code to your player, you will see the region code notice on the screen. The disk will not play, and should be unloaded.

Notes on Discs

HOW TO HANDLE, CLEAN, AND STORE DISCS.

Handling discs

- DO NOT TOUCH THE PLAYBACK SIDE OF THE DISC.
- DO NOT ATTACH PAPER OR TAPE TO DISCS.

Note:

Polaroid SHALL NOT BE RESPONSIBLE FOR DAMAGE THAT MAY OCCUR TO A DISC FROM BEING OPERATED IN THE UNIT.



Cleaning discs

- Fingerprints and dirt on the disc cause picture and sound deterioration. Wipe the disc from the center outward with a soft cloth. Always keep the disc clean.
- If you cannot wipe off the dirt off, wipe the disc lightly with a slightly moistened soft cloth and finish with a dry cloth.
- Do not use any of solvent such as paint thinner, benzine, commercially available cleaners or anti-static spray for vinyl LP's.

Storing discs

- Do not store discs in places subject to direct sunlight or near heat sources.
- Do not store discs in places subject to moisture and dust.
- Store discs vertically in a case. Stacking or placing objects on discs outside of their case may cause warping.

Playable discs

This unit can play back the following discs.

	Disk Mark	Contains	Disc Size	Maximum playback time
DVD video disc		Audio +Video (moving pictures)	12cm	Approx. 4 hours (single sided disc)
				Approx. 8 hours (double sided disc)
KODAK Picture CD		Spec.	12cm	
MP3 CD	MP3	Audio	12cm	Up to 10 hours
VHS		Audio +Video		

Notes on regional numbers

DVDs are divided into separate regions. The United States and Canada are designated as region 1 DVD.

Your unit plays region 1 DVDs only.

TABLE OF CONTENTS

INTRODUCTION

- Safety Precautions1
- Feature Descriptions5
- Specifications5
- Front and Rear Unit Profiles6
- Remote Control Features6

INSTALLATION

- Connecting the Antenna8
- Installing the Remote Control Batteries8
- Connecting A/V Equipment9

FUNCTIONS & FEATURES

- Turn On/Off11
- Basic Functions11
- Function Selection Menus
 - Picture Menu11
 - Sound Menu11
 - Tuner Menu12
 - TV Timer Menu12
 - General Menu12
- Useful Remote Control Features14

DVD FUNTIONS

- Playing Back a Disc15
- Using the On-Screen Display16
- Locating a Specific Title, Chapter or Track17
- Playing Repeatedly17
- Selecting Subtitles18
- Selecting the Camera Angles/Language/Audio Settings18
- Playing Back Your Kodak Picture CD19
- MP3 Operation19
- Setting the Parent Lock20
- Customizing the Function Selectings21

VCR FUNTIONS

- VCR Playback22
- Recording22
- Search Function23
- VCR Setting23
- Other Remote Control Features24

TROUBLESHOOTING GUIDE.....25

Instruction Manual

Feature Descriptions

181 Channel Tuner - Total number of channels the TV can receive: 2-69 in Air mode, or 1-125 in Cable mode

AV Input (Front) - Input designed for infrequent use, such as with a camcorder or video game unit

S-Video Input (Front) - Input designed for greater clarity and sharpness

AV Input (Rear) - Standard composite input designed for use with A/V devices, such as a DVD player

AV Output (Rear) - Output signals from TV to devices such as VCR's

RF IN Jack - Standard coaxial antenna jack

Channel Recall - Instant return to the last channel viewed

Closed Captions Display - Feature that displays the closed captions or text of a TV broadcast

Remote Control - A wireless remote control unit for the TV

On/Off Timer - Feature that allows the user to set a time for the TV to turn on or off

Parental Control - Feature that allows parents to block out selected types of programming

Screen Size - The diagonal size of the TV screen

Selectable Picture Modes - Preset standards for TV display: User, Normal, Movie and Sports

Selectable Sound Modes - Preset standards for TV sound: User, Normal, Speech Movie and Music

MTS Stereo/Video Stereo - Stereo sound for superior TV viewing experience

Trilingual On Screen Display (OSD) - TV's on screen display can be either English, French or Spanish

DVD/CD/MP3/KODAK Picture CD Support

SPECIFICATIONS

MODEL	TDX-2000AF
Television System	NTSC-M
Channel Coverage	VHF 2-13, UHF 14-69
Cable TV Coverage	Mid Band (A-8~A-1, A~I); Super Band (J~W) Hyper Band (AA~ZZ, AAA, BBB) Ultra Band (65~94, 100~125)
Channels Preset	181
Antenna Input	75 ohm (unbalanced)
Screen Dimensions	15.98 x 12.01 in. 406 x 305 mm
Audio Output	2W + 2W
Total Harmonic Distortion	<7%
Power Source	~120Vac, 60Hz
Unit Weight	68.2 lbs. (31 kg)
Unit Dimensions	22.91 x 21.06 x 19.37 in. 582 x 535 x 492 mm
Packaged Dimensions	26.38 x 24.88 x 22.64 in. 670 x 632 x 575 mm
Power Consumption	130W

Front and Rear Unit Profiles

Front panel

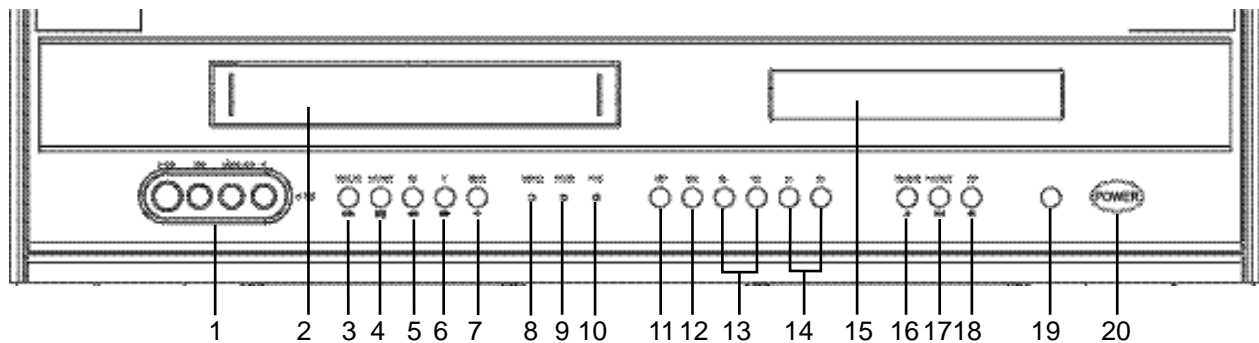

- | | | | |
|----------------|-----------------------|--------------------|------------------|
| 1 AV IN1 JACK | 7 REC/OTR | 13 VOLUME DOWN/UP | |
| 2 VCR DECK | 8 TIMER REC INDICATOR | 14 CHANNEL DOWN/UP | |
| 3 STOP/EJECT | 9 REC/OTR INDICATOR | 15 DISC TRAY | |
| 4 PLAY/PAUSE | 10 POWER INDICATOR | 16 OPEN/CLOSE | |
| 5 FAST REVERSE | 11 TV/VIDEO SELECT | 17 PLAY/PAUSE | 19 REMOTE SENSOR |
| 6 FAST FORWARD | 12 MENU SELECT | 18 STOP | 20 STANDBY |

Rear panel

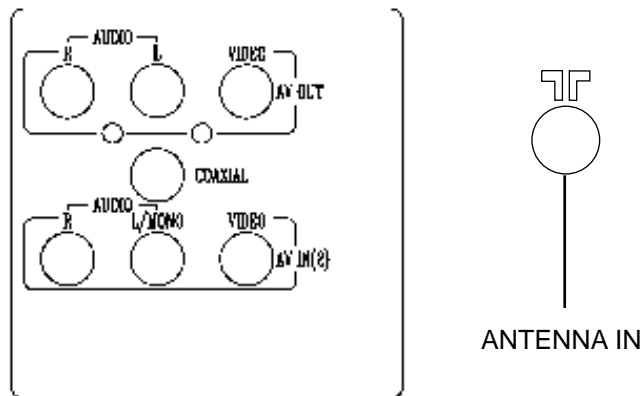

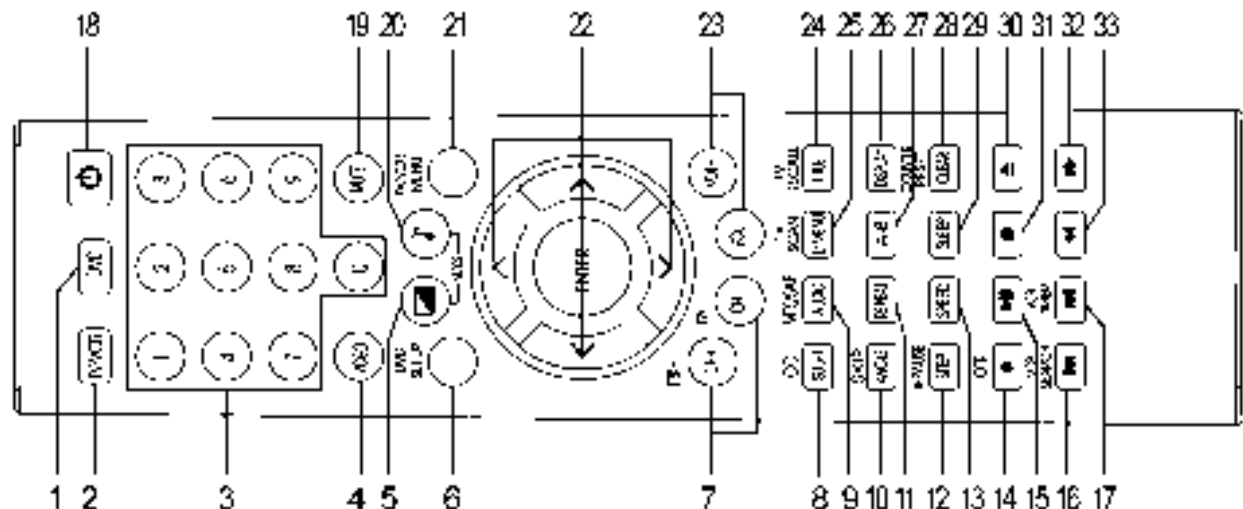

Remote Control Features



Instruction Manual

Remote Control Features

The keys marked with * have composite functions.

No.	Button	Function Description		
		TV	DVD	VCR
1	DVD	To enter DVD mode	---	To enter DVD mode
2	TV/VCR	---	To shift to TV/AV mode	---
3	0-9	Channel number (0-9)	Number (0-9)	
4	VIDEO	TV/Video select	---	
5	PICTURE	Picture mode select		
6	DVD SET UP	---	DVD setup	---
*7	CH-/+(TRK-/+)	Channel down/up	---	Tracking adjust
*8	 (SUB-T)	CCD/Text	Sub title	CCD/Text
*9	MTS/SAP(AUDIO)	Stereo/SAP	Audio	Hi Fi select
*10	ANGLE(SKIP)	---	Angle select	Skip forward
11	REPEAT	---	Repeat playback	---
*12	PAUSE(STEP)	To pause during recording	Step	To make picture advance frame by frame in the Still mode /To pause during recording
13	SPEED	To select speed of tape		---
14	OTR	One touch record		---
15	PLAY/PAUSE	To play	Play/Pause	Play/Still
*16	PREV(VCR SEARCH)	VCR search	Previous skip	VCR search
*17	NEXT(VCR TIMER)	VCR timer	Forward skip	VCR timer
18		Standby		
19	MUTE	Mute on/off		
20	SOUND	Sound mode select		
21	TV/VCR MENU	TV menu select		
22	 /ENTER	To navigate the menus/ To access the sub menus		
23	VOL-/VOL+	Volume down/up		
*24	TV RECALL(TITLE)	Channel recall	Title	---
*25	TV SCAN (D.MENU)	Channel scan	DVD menu	---
26	DISPLAY	On-screen display		
27	A-B	---	To repeat playback from point A to point B	
*28	COUNTER RESET (CLEAR)	Counter reset To clear a program in the TIMER RECORDING menu		
29	SLEEP	Sleep off		
30	EJECT	To eject tape	Open/Close	To eject tape
31	STOP	Stop		
32	FWD	FF	FWD	CUE1/CUE2
33	REV	REW		REV1/REV2

When  displayed during DVD playback, the function is not operational.

INSTALLATION

- Please read the safety instructions in this manual completely before installation.
- Install your unit in an area where direct sunlight will not fall upon the screen.
- Soft, indirect light is best for television viewing.
- Allow enough space (at least 4 in.) between the TV and any walls or enclosures for proper ventilation.
- Optimum television viewing distance is 3-5 times the screen's size.

Auto-Degaussing

Color TV is easily affected by magnetism which leads to color distortion. If your unit is moved or affected by near magnetic components or appliances with power on, please power off your unit for at least 1 hour. The built-in auto-degaussing circuit will eliminate the magnetism interference.

Auto off when no signal received

The TV set will automatically enter into Standby mode when the following conditions are met.

1. TV is in antenna mode.
2. Current channel has no signal.
3. No key is pressed within 15 minutes.

Connecting the Antenna

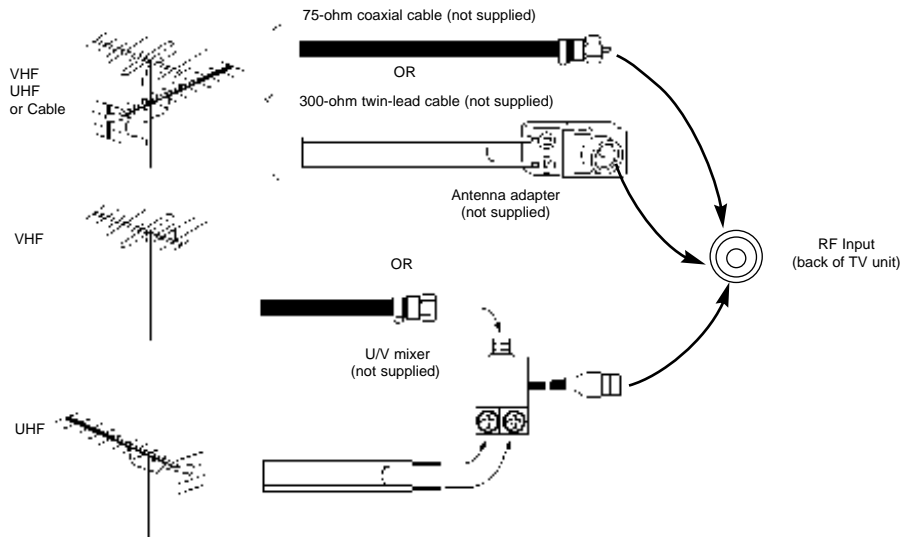

Notes:

- 1) It is recommended that a 75 ohm coaxial cable be used in order to eliminate interference and noise which may occur due to nearby radio transmissions.
- 2) The antenna cable should not be tied together with other wiring.
- 3) Set up a lightning rod and check it regularly when an outdoor antenna is used.

Installing the Remote Control Batteries

1. Remove the battery compartment lid.
2. Insert two AAA batteries (included). Make sure the positive (+) and negative (-) polarities are correctly aligned.
3. Reattach the battery lid.

Notes:

- 1) Alkaline batteries are recommended for longer life.
- 2) Always replace both batteries at the same time.
- 3) Do not expose batteries to fire or break them open.
- 4) To avoid battery leakage, remove batteries from the remote control when it is not being used for a long period of time.

INSTALLATION (continued)

Connecting A/V Equipment

The following are diagrams showing basic instructions for attaching external equipment, like a VCR or DVD player, to your unit. Please refer to operation manuals of external audio/video equipment that will be connected to your set for additional instructions. PLEASE TURN OFF ALL POWER BEFORE CONNECTING DEVICES TOGETHER.

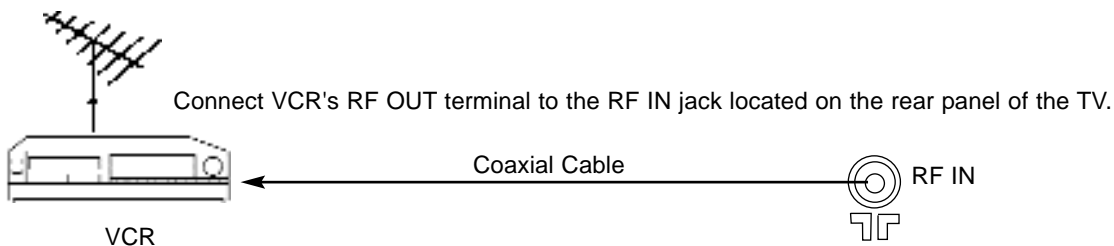

Input from Device to TV

AUDIO/VIDEO OUT

DO NOT connect both composite (yellow video terminal) and S-Video terminal. Use only one of the two. **Also, remember to connect the audio cables when using S-Video.**

DVD Player

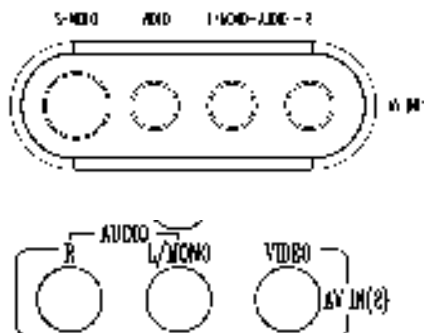
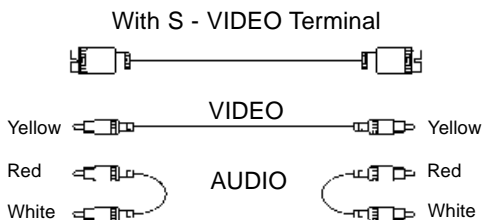
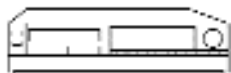
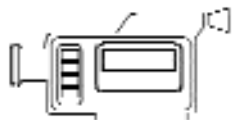

Output from TV to Device

AUDIO/VIDEO IN

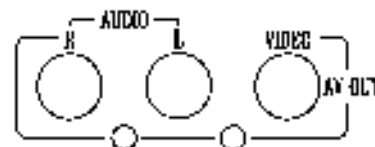
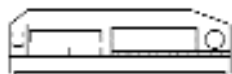

INSTALLATION (continued)

Connecting A/V Equipment (continued)

Enjoying Digital Stereo Sound (Digital Stereo)

Enjoy the dynamic sound of Digital Stereo by connecting an amplifier equipped with a digital audio input and speaker system (right and left front speakers).

Set "SPDIF Output" to "SPDIF/PCM" via the setup menu.

Enjoy DTS

DTS programming can deliver surround sound with five discrete full range channels plus a sixth channel for a subwoofer. You can enjoy your unit with a DTS Digital Surround Sound System. All you need is to connect your unit to a DTS receiver with an external decoder.

•How to setup the sound output:

From the "General Setup Page" display, set "SPDIF Output" to "SPDIF/RAW".

This product incorporates copyright protection technology that is protected by method claims of certain U.S. patents and other intellectual property rights owned by Macrovision Corporation and other rights owners. Use of this copyright protection technology must be authorized by Macrovision Corporation, and is intended for home and other limited viewing uses only unless otherwise authorized by Macrovision Corporation. Reverse engineering or disassembly is prohibited.

It is forbidden by law to copy, broadcast, show, play in public, or rent copyrighted material without permission. DVD video discs are copy protected, and any recordings made from these discs will be distorted.

Notes:

- (1) Do not connect the PCM/BITSTREAM jack of the unit to the AC-3 RF input of a Dolby Digital receiver. Instead, connect to the "DIGITAL" or "COAXIAL" input of a Dolby Digital/DTS receiver or Processor. The input of the AV receiver is not compatible with the PCM/BITSTREAM jack and is primarily for Laserdiscs only.
- (2) Connect the PCM/BITSTREAM jack of unit to the "DIGITAL" or "COAXIAL" input of a DTS receiver or Processor.
- (3) Refer to the manual of the connected Equipment.
- (4) Adjust the volume of your receiver to a comfortable listening level to avoid any speaker damage.

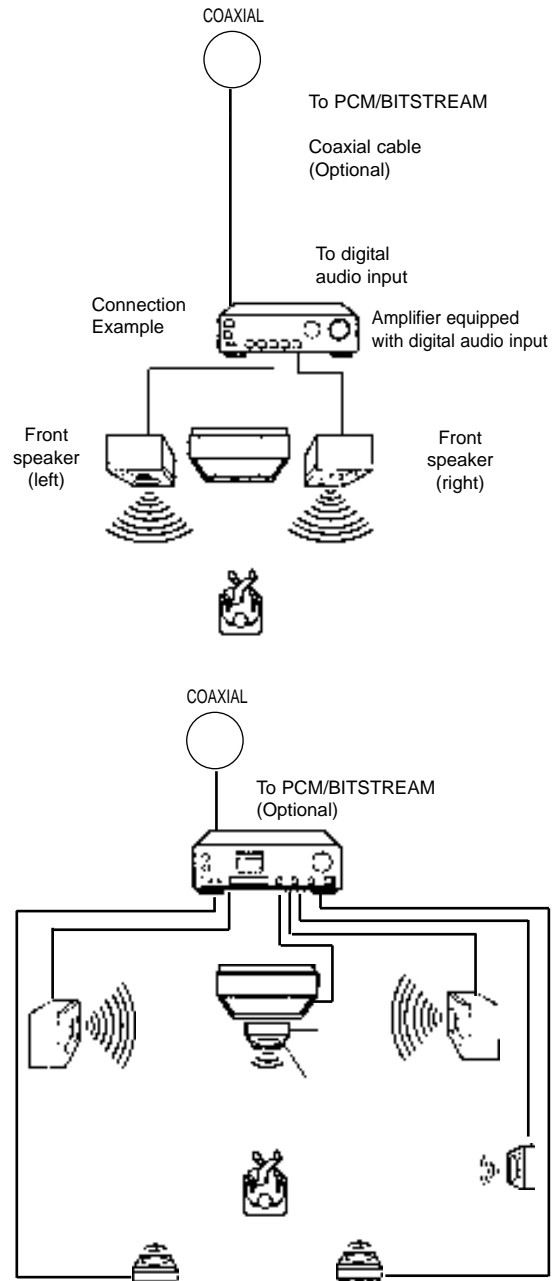

FUNCTIONS & FEATURES

Turn On/Off

1. Turn On

Plug in the power cord, and the TV should enter into Standby mode. Pressing **STANDBY** key will turn on the TV and its power indicator light.

2. Standby

While the TV is on, press the **STANDBY** key will put the TV in Standby mode. The power indicator light on the TV set will turn off.

Basic Functions

Changing the Channel

While in Tuner mode, press the **CH+/-** keys to change the channel, or use the **numeric** keypad to enter a new channel.

Adjusting the Volume

To adjust the volume, press the **VOL+/-** keys.

Muting the Volume

To mute the volume, press the **MUTE** key. To restore the volume, press MUTE again or press the **VOL +** key.

Function Selection Menus

To change the setting of any function, press the **TV/VCR MENU** key to bring up the main menu. Press **▲/▼** to highlight the desire sub-menu and press **</>** (or **ENTER**) to access. While in the sub-menu, press **▲/▼** to select the item and **</>** to adjust the setting. Press the **TV/VCR MENU** key to return to the main menu and exit.

While in the setup menu, **CH-/+** and **VOL-/+** key on the front panel will function as the **▼ / ▲ / </>** on the remote control.

Picture Menu

Features

This menu allows you to adjust the various picture settings.

- Tint:** -31 (more purplish) to +31 (more greenish)
- Brightness:** 0 (dimkest) to 63 (brightest)
- Contrast:** 0 (minimum contrast) to 63 (maximum contrast)
- Color:** 0 (minimum color) to 63 (maximum color)
- Sharpness:** 0 (minimum sharpness) to 63 (maximum sharpness)

Note:

To control picture artifacts reduce the sharpness setting when viewing DVD discs.

Picture	
☞ Tint 00
Brightness 32
Contrast 32
Color 32
Sharpness 32

Sound Menu

Features

This menu allows you to adjust the various sound settings.

- Bass:** 0 (less Bass) to 63 (more Bass)
- Treble:** 0 (less Treble) to 63 (more Treble)
- Balance:** L31 (Left Dominance) to R31 (Right Dominance)
- Surround:** Off, On
- AVC:** Off, On
- MTS:** Please refer to the description of **MTS/SAP** key (P14)

Sound	
☞ Bass 32
Treble 32
Balance 00
Surround	On
AVC	Off
MTS	Mono

FUNCTIONS & FEATURES (continued)

Tuner Menu

Note: This menu is only accessible while the TV is in Tuner mode.

Channel: This feature allows you to change the channel displaying on screen. Press </> or the numeric keypad to change the channel.

Add/Eraser: This feature allows you to add or remove the channel currently display on screen to the "active channel list" . Active channel list is the list of channel that is available by pressing the **CH+/-** keys. Press </> to add or erase.

Antenna: This feature sets the TV tuner to an Air antenna or a Cable antenna. Please use *Air* mode when using an over-the-air antenna; use *Cable* mode for a cable hookup. Press </> to select between the two options.

Auto Program: This feature will setup the Active channel list for the user. The list will include only the channels with a signal detected. Press > to begin and < to stop the process.

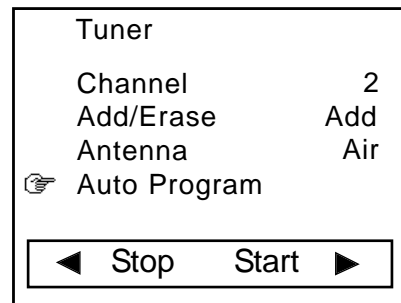

TV Timer Menu

Clock must be set first in the Clock Set menu.(P23)

Time

This feature allows the TV to display time on the TV screen.

On Time

This feature allows you to preset a time when the TV set will turn on.

On Channel

This feature allows you to preset the channel on display when the On Time is activated.

Off Time

This feature allows you to preset a time when the TV set will turn off.

Timer:Timer can be set to *Once* or *Always*.

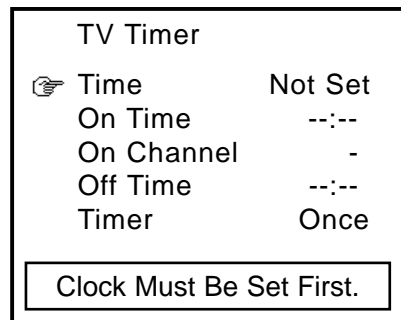

General Menu

Language

This feature allows you to pick a language used for the on screen display (OSD). Press </> to select the language of your choice - English (Eng.), French (Fra.) or Spanish (Esp.).

Blue Back

This feature gives you the option to display a blue background on the TV screen when there is no signal present. Press </> to toggle between on and off.

CCD/Text

Closed caption is a feature that allows your TV set to display, on screen, the dialogue, narration, and sound effect of a TV program. It also allows you to display teletext signal. Text and caption will be displayed at either the top or the bottom of the screen. There are nine different settings for closed captions . You can set it to one of the 4 Closed Caption settings (CC1-4), one of the 4 Text settings (T1-4), or set this feature to off (CCD/Text off).

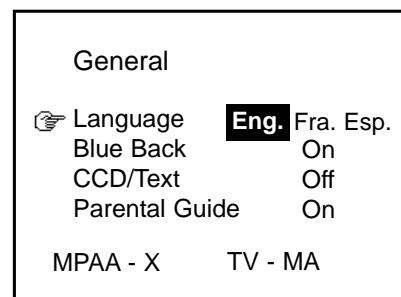

Notes: A Closed Caption signal may not be displayed under the following conditions:

- When there is no Closed Caption/Text signal to decode
- When the signal is weak or altered (due to interference or poor reception)
- When viewing a dubbed video tape

FUNCTIONS & FEATURES (continued)

General Menu (continued)

Parental Guide

This feature allows parents to block certain programs from being viewed, based on the program's rating. In order to access this menu, you must first enter a pass code. The factory default is **6688**. Enter the pass code while the Parental Guide is highlighted. Now, with Parental Guide set as On, press > to access the TV Rating grid.

TV Rating

Press \wedge/\vee to navigate between the ratings, press the **TV/VCR MENU** key to block out a particular rating completely. Or, if you wish, press \vee to highlight an individual rating (anywhere a *U* is displayed in the middle of the grid.) Pressing the **TV/VCR MENU** key with one of these individual ratings highlighted will block only programs that feature that particular aspect. See the TV rating diagram at right for an example. TV ratings are defined in the charts below:

Age	Defined as
TV - Y	All Children
TV - Y7	Directed to Older Children (over 7)
TV - G	General Audience
TV - PG	Parental Guidance Suggested
TV - 14	Parents Strongly Cautioned
TV - MA	Mature Audience Only

Contents	Defined as
FV	Fantasy Violence
D	Sexual Dialogue
L	Adult Language
S	Sexual Situations
V	Violence

MPAA Rating

Press > while in the TV Rating grid to access this grid. Press \wedge/\vee to navigate between the MPAA ratings. Pressing the **TV/VCR MENU** key with a rating highlighted will block that particular rating from being shown on this TV. A *B* will show in red next to the blocked rating. Please note that blocking a lower rating (for example, PG) will block all higher ratings (PG-13, R, NC-17, X.)

Pass Code Menu

This menu allows you to change the access code for the Parental Guide functions of the TV set. Press the **TV/VCR MENU** key when Pass Code Control is highlighted. This will turn on or off the Pass Code function. With the Pass Code function ON, you can also change the Pass Code. Press \vee to highlight *Pass Code*, then enter the new Pass Code using the numeric keypad.

Note:

The factory pre-set password is **6688**. The initial password will be replaced when the new one is used. Please contact the service centre in case you forget the password.

General

Language **Eng.** Fra. Esp.
 Blue Back On
 CCD/Text Off
 Parental Guide On
 MPAA-X TV-MA

Enter Pass Code - - - -

TV-Rating

Rating	FV	D	L	S	V
TV-Y U					
TV-Y7 U U					
TV-G U					
TV-PG U		U	U	U	U
TV-14 U		U	U	U	U
TV-MA U			U	U	U

Age Based Rating

MPAA - Rating

Movie	Rating
G U	
PG U	
PG-13 U	
R U	
NC-17 U	
X U	

Age Based Rating

Pass Code Menu

Pass Code Control
 Pass Code 6688

Enter Pass Code - - - -

FUNCTIONS & FEATURES (continued)

Useful Remote Control Features

DISPLAY

Pressing this key will display the current information of the TV on the screen. (channel, antenna mode, time, video, etc.) Pressing it again allows you to display the current information of the VCR. To turn off the display, press the key repeatedly.

SCAN

Press the **SCAN** key twice, and the TV will begin to scan through all active channels. To stop the Scan, pressing any key can interrupt scanning. Please note that Scan will only work in Antenna mode.

PICTURE

Your TV has factory preset picture modes that allow you to optimize your TV viewing. To activate these picture modes, press this key, and you can choose among User, Normal, Movie and Sports.

SOUND

Press this key repeatedly, and you can choose among User, Normal, Speech, Movie and Music.

RECALL

This key will allow you to return to the last channel you viewed. Pressing it again will return you to the channel you just left.

CC

Pressing the **CC** key will activate the currently selected Closed Caption or Text under the System Menu. Pressing it again will turn off the Closed Caption or Text.

VIDEO

This key allows you to toggle between antenna and different video modes.

0-9

Press the **0-9** keys to enter channel numbers directly (2-69 in the Air mode or 1-125 in the Cable mode). Press the corresponding Number key(s) to enter a channel number from high-digit to low-digit. Enter digits within 3 seconds of each other.

SLEEP

To determine the minutes before the TV turns off, press the **SLEEP** key repeatedly to switch the TV to one of the following modes :

--> 15-> 30-> 45-> 60-> 90-> 120-> 150-> 180 (Unit: Minute)

The TV will automatically enter the Standby mode when the preset Sleep time is up.

The TV will display a message one minute before the Sleep timer runs out.

MTS/SAP

In the TV mode, the TV can automatically identify MTS stereo modes such as Mono, Stereo, Stereo/SAP and Mono/SAP.

Signal Received	Press MTS/SAP key
Mono	Mono
Stereo	Stereo, Mono
Stereo/SAP	Stereo, SAP, Mono
Mono/SAP	Mono, SAP

DVD FUNCTIONS

Playing Back a Disc

1. How to playback a disc

- 1) Press **DVD** to enter the DVD mode.
- 2) Press **OPEN/CLOSE** to open the disc tray.
- 3) Place the disc on the disc tray. Be sure the playback side is face down.

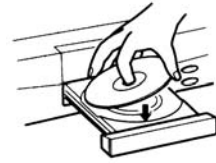

Note:

A disc may be damaged if not correctly placed on the guides in the disc tray. This may also cause the DVD player to malfunction.

- 4) Press the **PLAY/PAUSE** key. After closing the disc tray playback will start. The menu screen will appear automatically or you may access the menu screen by pressing **TITLE**.

Notes:

- (1) Moving the unit during playback may cause damage to the disc as well as the unit.
- (2) To open and close the disc tray, you should only use the **OPEN/CLOSE** key.

2. About DVD CD

DVD or CD icons will appear depending on the disc being played back.

DVD: DVD video discs

CD: Audio CDs

3. How to start playback from the menu screen

- 1) Press **▲/▼ / </>** or the **Number** keys to select the title.
- 2) Press the **ENTER** key. The DVD player will start playback from the title selected.

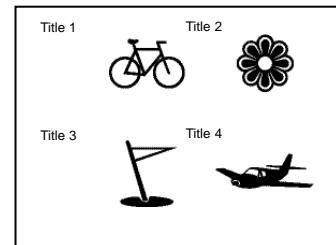

4. How to pause playback

Press the **PLAY/PAUSE** key during playback.

Press the **PLAY/PAUSE** key to resume normal playback.

5. How to remove the disc

Press the **OPEN/CLOSE** key. Wait until the disc tray is completely open before removing the disc.

After removing the disc, press the **OPEN/CLOSE** key to close the disc tray.

6. How to stop playback

Press the **STOP** key once. The DVD player is stopped.

Press the **PLAY/PAUSE** key to replay.

Press the **STOP** key twice. The DVD player is stopped completely.

Note:

At the completion of each movie a menu screen may appear. Be aware that the on-screen setup menu may damage your TV by permanently burning that image onto the screen. To avoid this, press the **STOP** key at the completion of each movie. You may also decide to setup the SCREEN SAVER.

7. Advanced playback

The DVD player allows you to playback discs at various speeds.

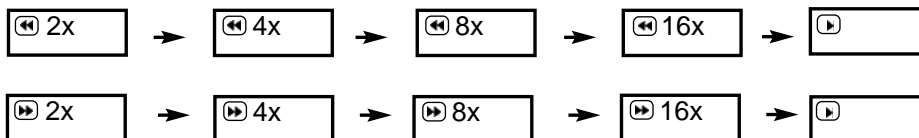

- 1) You can play back a disc at 2x, 4x, 8x, or 16x the normal speed.

Press the **REV** or **FWD** keys during playback.

The playback speed becomes 2x the normal speed.

The playback speed changes each time you press the **REV** or **FWD** key.

REV: Fast reverse **FWD**: Fast forward

Press **PLAY/PAUSE** to resume normal playback.

DVD FUNCTIONS(continued)

Playing Back a Disc (continued)

Note:

- The DVD Player may not playback sound during scan reverse or forward playback of DVD video discs. The DVD Player will play sound during fast forward or fast reverse playback of audio CDs.
- The speeds may vary slightly from disc to disc and the 2x, 4x, 8x, and 16x speeds are only approximate speeds.

8. Resuming playback from the same location

This DVD player allows you to stop playback and continue playback later from the same location on the disc.

1) Press the **STOP** key.

This will interrupt the playback and the DVD player memorizes the location where you stopped playback.

2) Press the **PLAY/PAUSE** key.

The DVD player will resume the playback from the location where you stopped playback.

Notes:

(1)The following actions will cancel the RESUME function:

- Unplugging the unit after you stop playback.
- Ejecting the disc.

(2) Depending on the disc, you may experience a difference of location where playback resumes

(3) Some discs do not utilize this feature.

Using the On-Screen Display

THE UNIT ALLOWS YOU TO VIEW THE DISC INFORMATION ON THE TV SCREEN.

Press **DISPLAY** during playback, you can view the following on the TV:

-Current title, Track number, Total playing time

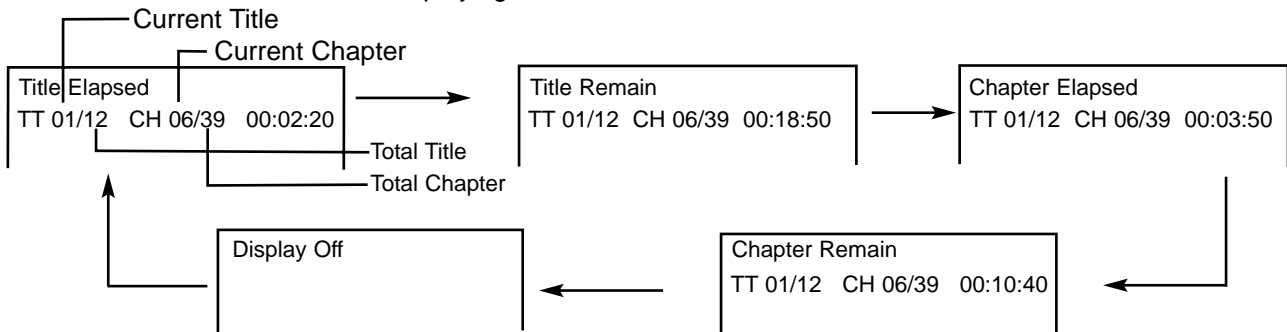

To turn off the on-screen display, press **DISPLAY** repeatedly.

DVD FUNCTIONS(continued)

Locating a Specific Title, Chapter or Track

THE DVD VIDEO DISCS ARE NORMALLY DIVIDED INTO TITLES. THE TITLES ARE SUB-DIVIDED INTO CHAPTERS. AUDIO CD AND MP3 DISCS ARE DIVIDED INTO TRACKS. YOU CAN CONVENIENTLY LOCATE ANY SPECIFIC TITLE, CHAPTER, OR TRACK WITH THIS UNIT.

Chapter1 Chapter2 Chapter3 Chapter4 Chapter5

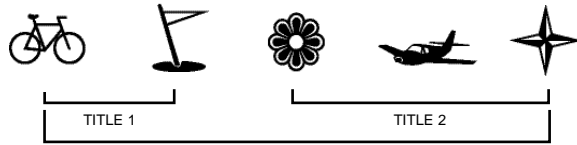

DVD Video Disc



Audio CD

1. Locating a title using the title menu

You can locate a specific title using the title menu function, if a DVD video disc contains a title menu.

- 1) Press the **TITLE** key. On the TV screen, the title menu will appear.
- 2) Press the **▲/▼/◀/▶** keys to select the title you want.

You can also directly locate a specific title by pressing its assigned number with the **Number** keys.

- 3) Press the **ENTER** key. This will cause the unit to start playback from chapter 1 of the title selected.

Notes:

- (1) You may find that some discs will not respond to this function.
- (2) If different instructions appear on the TV screen, follow those instructions. The instructions above describe the basic playback procedure. Procedures may vary depending on the contents of the DVD video disc.

2. Locating a specific chapter or track

This unit allows you to locate consecutive chapters or tracks.

Press the **PREV** or **NEXT** key repeatedly to display the requested chapter or track.

The DVD player starts playback from the selected chapter or track.

How to locate preceding chapters or tracks

- When you press the **PREV** key, the DVD player starts playback from the beginning of the preceding chapter or track.

How to locate succeeding chapters or tracks

- When you press the **NEXT** key, the DVD player starts playback from the beginning of the succeeding chapter or track.

Note: On some discs the titles may not display the sub-divided chapters.

Playing Repeatedly

THIS UNIT ALLOWS YOU TO PLAYBACK A SPECIFIC TITLE, CHAPTER, TRACK, OR SEGMENT REPEATEDLY. (TITLE REPEAT, CHAPTER/TRACK REPEAT, A-B REPEAT).

How to repeat a title, chapter or track

Select the title, chapter, or track you want to repeat.

Press the **REPEAT** key. The repeat mode changes each time you press the **REPEAT** key.

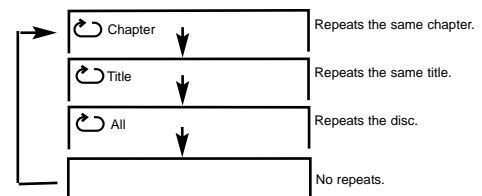

How to repeat a specific segment

1. Press the **A-B** key at the beginning of the segment in which you want to repeat playback. (point A)
2. Press the **A-B** key again at the end of the segment (point B).
The Combo Player will automatically return to point A and start to repeat playback of the selected segment (A-B).
3. Press the **A-B** key to cancel the A-B repeat function.
The Combo Player will resume to normal playback.

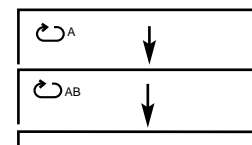

- Depending on the disc, you may experience a difference between point A and the location where playback actually resumes.
- Be aware that some discs will not respond to the A-B repeat function.

DVD FUNCTIONS(continued)

Selecting Subtitles

THIS UNIT ALLOWS YOU TO DISPLAY SUBTITLES INCLUDED ON THE DISC ON YOUR TV SCREEN.

How to display subtitles

You have the option to select a preferred subtitle from those included on the DVD video disc.

Press the **SUB-T** during playback until the subtitles disappears.

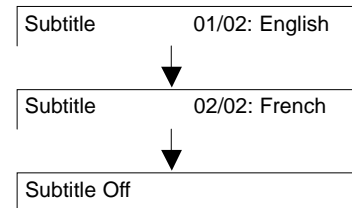

Notes:

- With some DVD's, you may not be able to turn off the subtitles and they will appear on screen automatically.
- If the subtitles continue to show on your TV even after the DVD has been turned off, please refer to the TV's close caption settings.
- As you press the **SUB-T**, the subtitles may not appear immediately during some scenes.

Selecting the Camera Angles/Language/Audio Settings

THIS UNIT ALLOWS YOU TO SELECT FROM SEVERAL DIFFERENT ANGLES AND LANGUAGES.

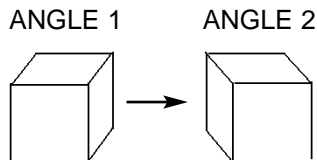

Selecting the camera angle

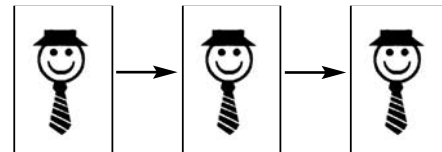

Selecting a language

1. How to change the camera angle

Press the **ANGLE** key while playing back a scene recorded with multiple angles.

Each time you press the **ANGLE** key, the angle will change.

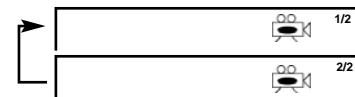

Notes:

- (1) The angle function will not work on DVD video discs that do not contain recorded multiple angles.
- (2) The angle icon indicator will illuminate while playing back a title that contains at least one scene recorded from multiple angles.

2. How to select a playback audio setting

This DVD player allows you to select a preferred language and sound recording system from those included on the DVD video disc.

1) Press the **AUDIO** key during playback.

2) Press the **AUDIO** key again to cycle backwards.

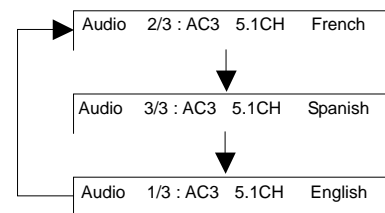
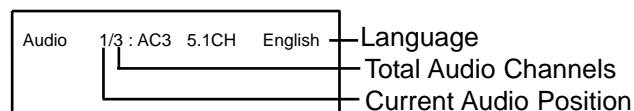

Note:

The DVD player returns to the initial default settings when you turn on the DVD player or replace a disc.

DVD FUNCTIONS(continued)

Playing Back Your Kodak Picture CD

1. Normal

When a Kodak Picture CD is inserted, an automated slide show is launched, each picture in the current directory will be displayed consecutively in a slide-show fashion and will be scaled to fit most of the TV screen. Fifteen slideshow transition modes are provided.

To display an image indefinitely, press the **PLAY/PAUSE** key. To view the Next or Previous picture, press the **NEXT** or **PREV** key. To resume the slideshow press the **PLAY/PAUSE** key.

2. Image rotation

There are four modes to transformation: "Invert", "Mirror", "Left", and "Right". The arrow keys are used to select the different transformation modes:

UP Δ - Invert/Normal Down ∇ - Mirror/Normal
Left \leftarrow - Turn left Right \rightarrow - Turn right

3. Menu

The **D.MENU** key is used to display thumbnail pictures. After it is enabled, up to twelve scaled-down thumbnails pictures will be displayed on the screen. The **NEXT** and **PREV** keys can be used to display the NEXT and PREVIOUS twelve pictures in the current directory.

Note: You can use the $\Delta/\nabla/\leftarrow/\rightarrow/\text{ENTER}$ to select.

MP3 Operation

1. Insert a MP3 CD, the DVD player will initialize the disc when the tray is closed and the directory (folder) will be shown in the MENU on screen.
2. Press \leftarrow/\rightarrow then the Δ/∇ key to select and highlight a MP3 file (song).
3. Press **ENTER** to play the file.



DVD FUNCTIONS(continued)

Setting the Parental Lock

YOU CAN USE THE PARENTAL LOCK FUNCTION ONLY WITH DVD VIDEO DISCS EQUIPPED WITH THE PARENTAL LOCK FEATURE.

Setting the parental lock

DVD video discs equipped with the parental lock function are rated according to their content. The contents allowed by a parental lock level and the way a DVD video disc can be controlled may vary from disc to disc. For example, if the disc allows, you can edit out violent scenes unsuitable for children and replace them with more suitable scenes, or lock out playback of the disc all together.

1. Press **STOP** twice during playback.
2. Press **DVD SET UP**. The SETUP MENU appears on the TV screen.
3. Select Preference page, press **ENTER**.
4. Select Parental, press direction keys.
Select Parental, press **ENTER**.
5. Enter your password then press **ENTER** key.
The preset password is **1225**.

To change your password:

- 1) Follow step 3 to select password change.
- 2) Enter old password.
- 3) Enter new password.
- 4) Re-enter to confirm your new password.
- 5) Press **ENTER**.
- 6) Press **DVD SET UP**.



DVD FUNCTIONS(continued)

Customizing the Function Settings

THIS UNIT ALLOWS YOU TO CUSTOMIZE THE PERFORMANCE TO YOUR PERSONAL PREFERENCES.

Displaying the setup menu screen

The SETUP MENU screen asks you to select a setting category from General Setup, Speaker Setup, Audio Setup, and Preferences. The selected category will provide you the setting details on-screen.

1. Press **DVD SET UP**.
2. Press **▲/▼/◀/▶** to select category (highlight), then press **ENTER**.
3. Press **DVD SET UP** to normal playback.

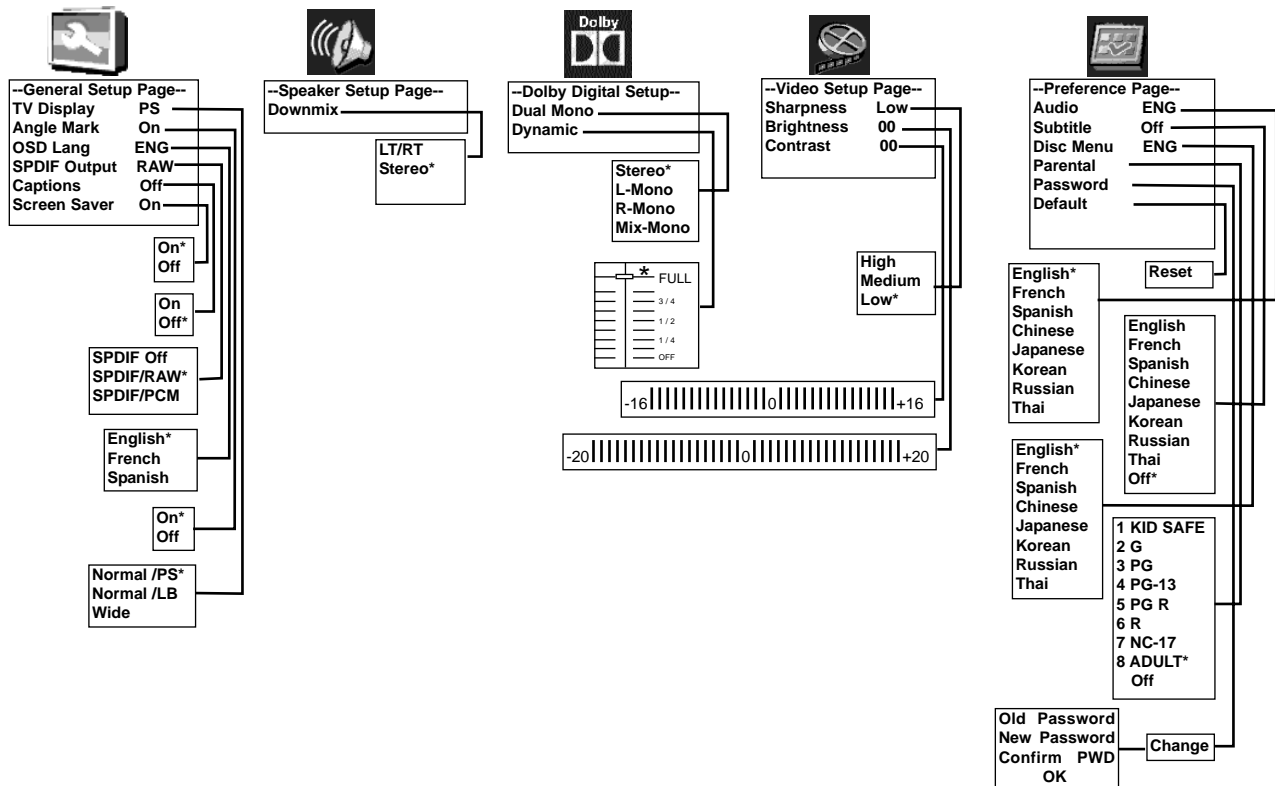

Notes:

- Preset password is **1225**.
- Highlighted function will be expanded at bottom of the screen.
- The SETUP MENU screen disappears if you press the **DVD SET UP** key while it is displayed.
- Functions and menu may change without notice.
- You must press **STOP** twice to set up Preferences.

VCR FUNCTIONS

VCR Playback

1. Insert the desired tape.
(In the DVD mode, you must first press the **TV/VCR** key to change to TV mode.)
2. If you want to playback it, press **PLAY/PAUSE** key.
When the playback picture is partially noisy, adjust with **TRK-/+** key.
3. To stop it, press **STOP** key.
For still, press **PLAY/PAUSE** key in playback mode.
4. To playback forward fast or to reverse it, press **FWD** or **REV** key respectively.
Press **STOP/EJECT** key on the front panel or **EJECT** key on the remote control to remove the tape.

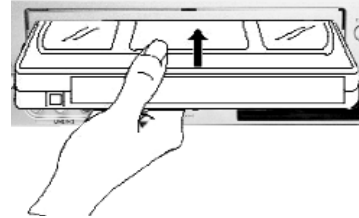

Recording

•To record with VCR

Insert a tape for recording. The tape must have a recording tab.
With **CH+/-** and **Number** keys, select the desired broadcasting channel or external input unit to record. Select the desired speed (SP or SLP) with **SPEED** key. Press **REC** key.
Press **PAUSE** key to pause recording, press again to resume.
If the pause status continues for five minutes, the recording will be cancelled automatically.
To stop recording, press **STOP** key.

•To play a DVD during VCR recording

If you want to playback a DVD during VCR recording, insert a DVD disc.
When the desired DVD disc is loaded, press the **DVD** key to switch to DVD mode and press the **PLAY/PAUSE** key to watch the DVD.

•To record from DVD to videotape

Press **DVD** key to switch output to DVD mode. Insert the desired DVD disc. (You cannot record a DVD disc which is copy protected.)
Insert a tape for recording. Press **REC** key. To stop record, press **STOP** key. If you do not press stop, the DVD plays on and video continues to record.

This product incorporates copyright protection technology that is protected by method claims of certain U.S. patents and other intellectual property rights owned by Macrovision Corporation and other right owners. Use of this copyright protection technology must be authorized by Macrovision Corporation, and is intended for home and other limited viewing uses only unless otherwise authorized by Macrovision Corporation. Reverse engineering or disassembly is prohibited.

•One touch timer recording (OTR)

One-Touch Recording (OTR) allows you to record in 30-minute increments up to 4 hours at the touch of a key.

Start recording: Following the instructions on "Recording".

Activate OTR: While in Record mode, press the **OTR** key again to activate One-Touch Recording (OTR).

Add recording time:

Press the **OTR** key to add recording time in 30 minute increments up to 4 hours.

The unit stops recording automatically when the time has elapsed.

VCR FUNCTIONS(continued)

Search Function

Go to Zero Search

As soon as the counter searches 0:00:00 , the tape will play automatically.

Counter Search

With Δ/V or **Number** key, enter the desired time and press **ENTER**. The counter appears on screen. When the counter searches the set number, the tape will play automatically. If not, "Start of tape" or "End of tape" will appear on the TV screen.

Index search (+) / Index search (-)

To search in the forward direction, highlight Index Search(+) Index searching motion, then press **ENTER**.

To search in the reverse direction, highlight Index Search(-) Index searching motion, then press **ENTER**.

- The index signal is recorded on the tape automatically when the recording is started. You can view a recording at a specific start point.

Index Number Search

- To search in the forward direction, press up key to select desired Index Number. To search in the reverse direction, press down key to select desired Index Number. After setting up, please press **ENTER**.

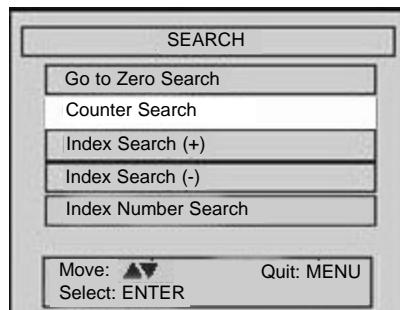

VCR Setting

Clock Set

Set the current date and time with $\Delta/V/|</>$ or **Number** keys. For Date set, follow the order of month/day/year; for TIME set, follow the order of hour/minute in CLOCK SET menu. Press **TV/VCR MENU** after completed.

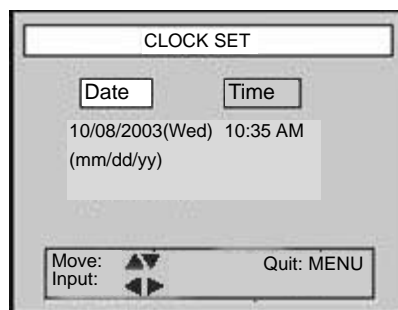

VCR Timer

1. Channel

Move into desired channel signal with left/right key.

Cable → Video1(S) → Video2 → Antenna



2. Start Date

Select the desired date to record with left/right or **Number** key.

3. REC Cycle

One Time → Weekly → Weekdays → Daily



4. Start Time/End Time

Select the desired time to record with left/right or **Number** key.

5. Tape speed

SLP=1/3 SP

Press **TV/VCR MENU** to exit after completed.

Repeating the above steps you can program up to 8-events.

After programming the timed recordings, press the **CLEAR** key to exit the program.

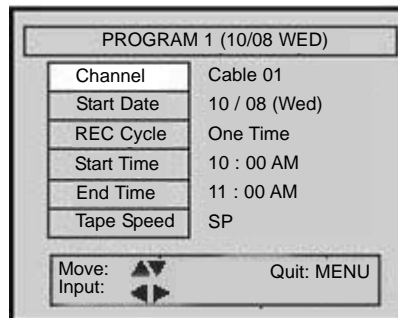

VCR FUNCTIONS(continued)

Other Remote Control Features

A-B

During tape playback, press the key once. The player will memorize the beginning of a segment (point A) and continue to play. Press it again. The combo will memorize the end of a segment (point B). At the same time, it will return to point A and start to repeat playback of the selected segment (A-B). After repeating playback of the segment five times, the player will resume to normal playback from point B.

SKIP

Each time you press the key during tape playback, the tape skips forward by 30 seconds, and then returns to normal playback.

PAUSE/STEP

During recording (except timer recording), pressing the key pauses recording until you press it again. The player continues to record at the location where the taped is paused.

During tape playback, the key does not function. During still playback, pressing the key will make pictures advance frame by frame. The still function will be released if there is no operation for 5 minutes. The VCR will change to the STOP mode.

F.ADV (Frame advance): Each time you press the key during still playback, the picture advances one frame. Press the **PLAY/PAUSE** key to resume normal playback.

Tape Handling

1. Do not use damaged or defective tapes. Faulty tapes may cause damage to the VCR play heads and mechanism. Do not use video tapes with the following conditions.
 - Tapes with mold
 - Tapes stained with liquids, debris or other substances
 - Tapes with crinkles, snags or breaks
 - Disassembled tapes
2. Moisture condensation may occur in tape. Moisture condensation damages the tape. Please use the tape after the moisture condensation has disappeared.
3. After use, store tape vertically in a case to prevent loose.
4. Do not store tapes in places with the following conditions:
 - High temperature and humidity
 - Areas subject generation of mold
 - Areas in direct sunlight
 - Areas subject to dust and dirt
 - Near strong magnetic materials such as speakers

TROUBLESHOOTING GUIDE

Check the following guide for a possible correction to a problem before contacting customer support.

Symptoms	Correction
No power	<ul style="list-style-type: none"> • Connect the power plug into the wall outlet securely.
Dark, Poor or No picture	<ul style="list-style-type: none"> • Verify the connection from the VCR video output to the TV video input is secure. Then switch TV to the appropriate Video mode by pressing TV/VIDEO button. • Adjust picture setting for tint, color brightness and sharpness. • Verify coaxial cable from antenna is connected to RF IN.
No sound	<ul style="list-style-type: none"> • Connect the audio cables into the terminals securely. • Verify the connection from the VCR audio output to the TV audio input. Then switch to the appropriate mode on the receiver. Refer to your audio amplifier owner's manual. • Verify the volume is at an appropriate level • The mute feature may be enabled, press MUTE button to verify.
No TV signal	<ul style="list-style-type: none"> • Check whether AMP your receiver is set to the TV mode (if connected). • Check whether the antenna is well connected to the TV receiver. • Unplug the TV from the wall for 30 seconds, then plug in and try again. • Unplug the antenna connection from the back of the TV, unplug the TV from the wall. Wait for 30 seconds, then power on again.
Stripe or purple interference appears in the screen	<ul style="list-style-type: none"> • Interference may come from high frequency sources such as a broadcasting station, poor ground connection in cable used, or non shielded audio speakers too close to the picture tube.
Picture becomes snowy.	<ul style="list-style-type: none"> • Verify the antenna lead wire is in working condition . • Verify the antenna is connected securely to the RF in jack .
Picture with multi -image	<ul style="list-style-type: none"> • Change the direction of antenna to minimize the multi image. • The video frequency radiated from TV station can be reflected by tall buildings, high tower, etc.
TV channel not received	<ul style="list-style-type: none"> • Make sure the Air/Cable setting is correct. • Channel may be locked with block channel feature, such as Parental Control. Refer to manual. • Check Add/Erase feature, as channel may have been erased during set up. Refer to manual.
Black box appears on screen.	<ul style="list-style-type: none"> • Closed Caption to Text feature may be active.
Remote control doesn't operate.	<ul style="list-style-type: none"> • Batteries may be weak. Replace batteries. • Check the batteries are installed with the correct +/- polarity. • Make sure remote sensor is not blocked by anything, including deflection from a glass cabinet.
Brightness is unstable or noises are produced on playback pictures	<ul style="list-style-type: none"> • What you're viewing may be effect of the copy protection circuitry required on all DVD players. • Do not connect and monitor through another VCR. • Try another disc.
The DVD video player doesn't start playback	<ul style="list-style-type: none"> • Place the disc with the graphics side up and clear side down. • Place the disc on the disc tray correctly inside the guide. • Make sure the disc is free from scratches & fingerprints. • Press the SETUP button to turn off the menu screen. • Cancel the parental lock function or change the parental lock level. (Preset password: 1225.) • Turn the power off then disconnect the power plug for 30 seconds and reinsert it back into the wall. Power on again. • Use region 1 disc only.
MP3 won't read disc or it skips	<ul style="list-style-type: none"> • Reburn disc as the software edition used may not be compatible with the player. Check software maker's web site for instructions. • Use new editions of software such as Voyetra Audiosation 4, Adaptec's "Easy CD Creator" or NT 1. Roxio's Toast Titanium, etc. • Make sure MP3 file are not encoded with a variable bit rate such as provided by Real Networks.
Timer recording failure	<ul style="list-style-type: none"> • Make sure the timer recording is set correctly. • Make sure power is off. To activate timer and verify you indicated proper AM/PM mode. • Make sure the clock is set correctly.
Cannot go into Record mode.	<ul style="list-style-type: none"> • Make sure the tape has a safety tab. If needed, cover the hole with adhesive tape.
Playback picture is partially noisy	<ul style="list-style-type: none"> • Adjust tracking control for a better picture by pressing the TRK+/- key.
Cannot view a tape but the audio is OK	<ul style="list-style-type: none"> • Head cleaning may be necessary.
Video or color fades in and out when making a copy of a video tape.	<ul style="list-style-type: none"> • This could be the result of copy guard protection. You cannot copy a copyrighted video tape.
Cannot remove the tape	<ul style="list-style-type: none"> • Check if the player is in the TV/VCR mode. If not, press the TV/VCR key to switch the mode.

English

For service, support and warranty information, visit www.polaroidelectronics.com or in the US call 1-866-289-5168, in Canada call 1-866-301-7922 and in Mexico call 01-800-400-2443.

"Polaroid" is a registered trademark of Polaroid Corporation of Waltham, MA USA and licensed for use on the TBX-2000AF to Petters Consumer Brands, LLC.

French

Pour les informations concernant l'entretien, l'assistance et la garantie, visiter www.polaroidelectronics.com ou appeler le 1-866-289-5168 aux États-Unis et le 1-866-301-7922 au Canada. Au Mexique appeler le 01-800-400-2443.

"Polaroid" est une marque déposée de Polaroid Corporation, Waltham, MA, États-Unis, et dont l'usage est autorisé pour le TBX-2000AF auprès de Petters Consumer Brands, LLC.

Spanish

Para información relacionada al mantenimiento, soporte y garantía, visite www.polaroidelectronics.com o, en los Estados Unidos, llame al 1-866-289-5168. En Canadá, llame al 1-866-301-7922. En México llame al 01-800-400-2443.

"Polaroid" es una marca registrada de Polaroid Corporation, Waltham, MA, USA. Petters Consumer Brands, LLC, ha sido autorizado para usarla en el TBX-2000AF.

Free Manuals Download Website

<http://myh66.com>

<http://usermanuals.us>

<http://www.somanuals.com>

<http://www.4manuals.cc>

<http://www.manual-lib.com>

<http://www.404manual.com>

<http://www.luxmanual.com>

<http://aubethermostatmanual.com>

Golf course search by state

<http://golfingnear.com>

Email search by domain

<http://emailbydomain.com>

Auto manuals search

<http://auto.somanuals.com>

TV manuals search

<http://tv.somanuals.com>