

8GB

 **Polaroid**

Music & Video Player with
2.8" Touch Display

PMP281-8



User Guide

In the box

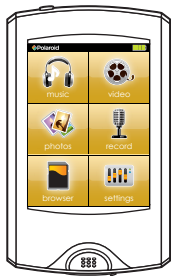

MP3 Player

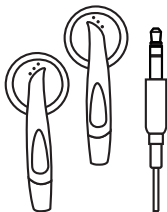

Headphones

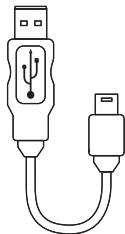

USB Cable



Quick Start Guide



Applications CD

To view the full manual

The complete User Manual is included on the CD. If you would like to view it, please follow the steps below.

1. Insert the included Applications CD into your computer's CD drive.
2. The CD should open automatically. On the screen that appears, press "User Guide".



If the CD does not open automatically, you can open it manually by choosing "Computer" and the CD-drive of your computer.

Location of controls

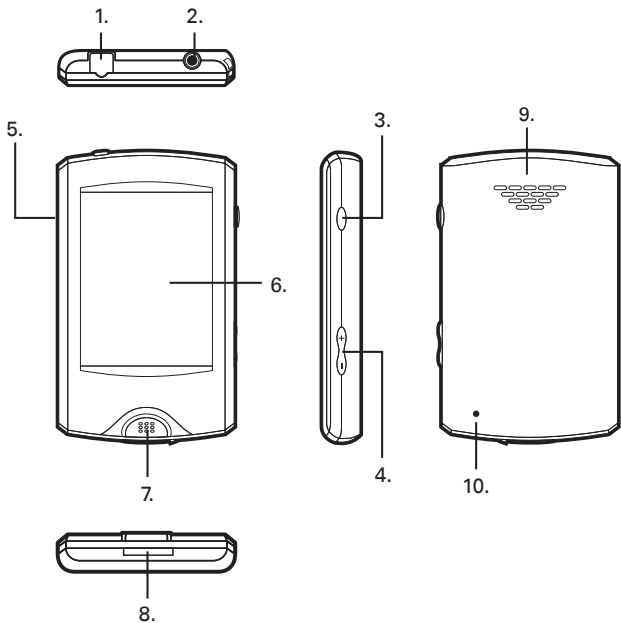

1. Mini-USB port

2. Headphone jack

3. **[POWER]** Power on/off

4. **[+]** Volume up

[-] Volume down

5. Microphone

6. Touch screen display

7. Play/pause/home

8. Micro SD card slot

9. Speaker

10. Reset

Inserting the Micro SD card

The player supports Micro SD cards (not included), which allow you to add up to 32GB additional memory to your MP3 Player.

To insert the Micro SD card:

1. Insert the Micro SD card into the card slot with the metal contacts facing down towards the back of the player, and gently push it in until it clicks. Do not apply excessive force, as this may damage your MP3 Player and Micro SD card.
2. To view files on your Micro SD card, touch **"browser"**, from the main menu and select **"Card Memory"**.
3. To remove the Micro SD card, gently push it in until it pops out.

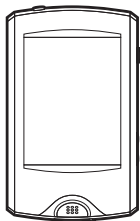

Micro SD
(Insert contacts facing down)



- Do not use force while inserting or removing the Micro SD card.
- Do not remove the card during file transfers.
- Make sure the player is turned off before inserting or taking out the card.

Charge/Power on/off

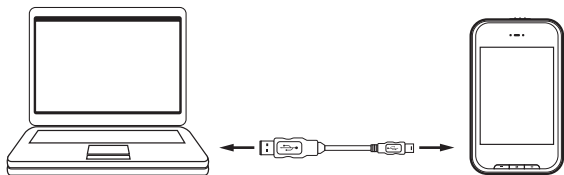

1. Connect your MP3 Player to your computer using the included USB cable.
2. Charge the battery between 3-5 hours. Do not charge for more than 8 hours.

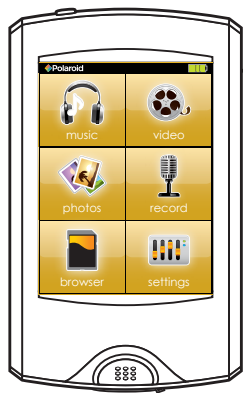

Power Button

After turning on your MP3 Player, you will see the main menu.

Touch an option to select it.

Transferring media files to your MP3

1. Find music, picture, or video files on your computer.

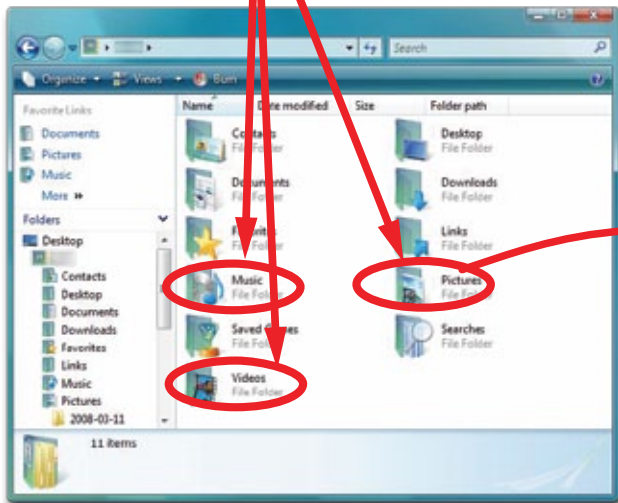

2. Connect the MP3 Player to your computer, and locate "MP3"

3. Drag the files into the Music, Pictures or Video folder.

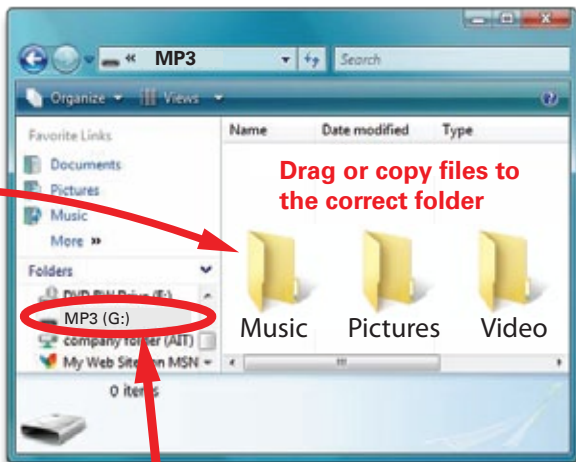

Locate "MP3"

*Screenshots above may be slightly different

Play media

Depending on what you're doing on your MP3 Player, the different buttons perform different functions.

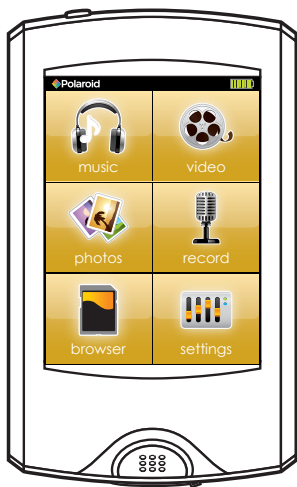

In a Menu/List:

[+] moves the selection up

[-] moves the selection down

[] • makes a selection

• Press & hold to return to the main menu









Music

[] plays/pauses the music

[] increase volume

[] decrease volume

1. Select “music” in the main menu, the music screen appears.
2. Press the  or  button to play or pause music.
3. To skip tracks, press the  or  button.
4. To fast forward or rewind within a track, press and HOLD the  or  button.

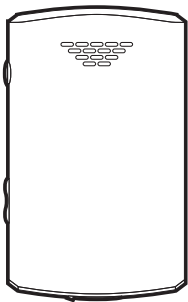

This player has a built-in speaker which allows you to enjoy your music out loud when the headphones are not connected to the player.









Video

[] plays/pauses the video

[+] increase volume

[-] decrease volume

1. Select "video" in the main menu.
2. Use the [+] or [-] button to select a video file, and press the [] button.
3. Press the  or  button to play or pause video.
4. To skip videos, press the  or  button.
5. To fast forward or rewind, press and HOLD the  or  button.



Photos

[] plays/pauses slideshow

[+] next photo

[-] previous photo

Legal information

FCC Part 15:

This equipment has been tested and found to comply with the requirements for a Class B digital device under Part 15 of the Federal Communications Commission (FCC) rules. These requirements are intended to provide reasonable protection against harmful interference in a residential installation. This equipment generates, uses and can radiate radio frequency energy and, if not installed and used in accordance with the instructions, may cause harmful interference to radio communications. However, there is no guarantee that interference will not occur in a particular installation. If this equipment does cause harmful interference to radio or television reception, which can be determined by turning the equipment off and on, the user is encouraged to try to correct the interference by one or more of the following measures:

- Re-orient or relocate the receiving antenna.
- Increase the separation between the equipment and receiver.
- Connect the equipment into an outlet on a circuit different from that to which the receiver is connected.
- Consult the dealer or an experienced radio/TV technician for help.

Do not attempt to repair or modify this equipment.

Warning: Changes or modifications to this equipment not expressly approved by the party responsible for compliance could void the user's authority to operate the equipment.

"This device complies with Part 15 of the FCC Rules. Operation is subject to the following two conditions:

- (1) this device may not cause harmful interference, and
- (2) this device must accept any interference received, including interference that may cause undesired operation."

Shielded USB cables must be used with this unit to ensure compliance with the Class B FCC limits.

PLR IP Holdings, LLC, its licensees and affiliates, fully supports all electronic waste initiatives. As responsible stewards of the environment, and to avoid violating established laws, you should properly dispose of this product in compliance with all applicable regulations, directives or other governances in the area where you reside. Please check with local authorities or the retailer where you purchased this product to determine a location where you can appropriately dispose of the product.

You may also go to [HYPERLINK "http://www.polaroid.com"](http://www.polaroid.com) www.polaroid.com and reference About / Electronic Recycling to learn more about the specific laws in your area and to locate a collection facility near your home.

If your electronic device has internal memory on which personal or other confidential data may be stored, you may want to perform a data sanitization process before you dispose of your device to assure another party cannot access your personal data. Data sanitization varies by the type of product and its software, and you may want to research the best sanitization process for your device before disposal. You may also check with your local recycling facility to determine their data sanitization procedures during the recycling process.

Troubleshooting

Can not power on

- The battery may be exhausted, please recharge the battery.

Files can not be transferred to the player

- Check if the driver is installed correctly in the computer by disconnecting and then reconnecting the player to the computer
- Check the connection between the player and PC, and confirm the USB cable is properly connected.

No sound from the headphones

- Please ensure the volume is turned up, and the headphones are properly connected.
- Check if the format of music file is supported by the player.

Can not record

- Check if there is enough memory and battery capacity.

Display is in the wrong language

- Please ensure you selected the correct language from the "Settings" menu.

The buttons do not work

- Slide the **[POWER]** switch to the right to unlock the player.

I cannot display my .jpg files

- Many digital cameras and image editing softwares add hidden data to the .jpg files. This data can prevent the player from loading the images. Try to eliminate them by saving the file with another name.

Resetting the player

If the player malfunctions, you can use the reset function to restart it.

- To reset the player, take a metal pin (such as the end of a paperclip), and push it into the RESET hole to restart the player.

Limited Warranty

This Product is supplied and distributed new by AIT, Inc. ("AIT") to the original consumer purchaser and is warranted by AIT against defects in material and workmanship for a period of one year from your date of purchase ("Warranty").

In the unlikely event that this product is defective, or does not perform properly, you may within one year from your original date of purchase return it to the authorized service center for repair or exchange.

TO OBTAIN WARRANTY SERVICE:

- Provide proof of the date of purchase within the package (Dated bill of sale)
- Prepay all shipping costs to the authorized service center, and remember to insure your return.
- Include a return shipping address (no P.O. Boxes), a telephone contact number, and the defective unit within the package.
- Describe the defect or reason you are returning the product. Your product will be repaired or replaced, at our option, for the same or similar model of equal value if examination by the service center determines this product is defective. Products received damaged as a result of shipping, will require you to file a claim with the carrier.

The shipping address of the authorized service center is:

AIT, Inc.

ATTN: Returns Department
14-C 53rd Street Brooklyn, NY 11232

IN NO EVENT WILL AIT, ITS MANUFACTURERS, DISTRIBUTORS OR PLR IP HOLDINGS, LLC BE LIABLE FOR ANY INCIDENTAL, DIRECT, INDIRECT, SPECIAL, PUNITIVE OR CONSEQUENTIAL DAMAGES (SUCH AS, BUT NOT LIMITED TO, DAMAGES FOR LOSS OF PROFITS, BUSINESS, SAVINGS, DATA OR RECORDS) RELATED TO THIS PRODUCT. EXCEPT AS STATED HEREIN, NO OTHER WARRANTIES SHALL APPLY.

Should you have any questions or problems concerning this product, please contact our customer service department at:

Customer Support:

☎ 1-877-768-8483 (Toll Free)

✉ polaroidsupport@southerntelecom.com

Monday - Thursday: 9AM - 5PM (EST)

Friday: 9AM - 3PM (EST)

Free Manuals Download Website

<http://myh66.com>

<http://usermanuals.us>

<http://www.somanuals.com>

<http://www.4manuals.cc>

<http://www.manual-lib.com>

<http://www.404manual.com>

<http://www.luxmanual.com>

<http://aubethermostatmanual.com>

Golf course search by state

<http://golfingnear.com>

Email search by domain

<http://emailbydomain.com>

Auto manuals search

<http://auto.somanuals.com>

TV manuals search

<http://tv.somanuals.com>