

RMDS-1

**INSTRUCTION
MANUAL**



RMDS-1

Table of contents

Safety Warnings4

RMDS-1 Features.....5

Carton Contents6

Quick Start Guide6

Rear Panels Guide7

System Hook Up, Overview Illustrations8, 9

Hooking Up the System10-13

Radio Antennas.....10

DVD Player.....10

DSS Receivers11

VCR11

CD Player11

Audio Tape Deck11

Laserdisc Player.....12

Television/Monitor12

Subwoofer12

Speakers13

AC Power13

Speaker Placement.....14

Wall Mounting Satellites15

Preamp/Processor Front Panel Guide.....16, 17

Remote Control Guide.....18, 19

Calibration (optional)20, 21

How to Use the System22, 23

About Surround Sound24

Multi-Room Hook Up and Use25

Troubleshooting, Maintenance and Service26, 27

Warranty27

Overall System Hookup.....28, 29

Specifications30

A word from Matthew Polk

Dear Home Entertainment Buff,

Thank you for purchasing the Polk Audio RM Digital Solution. Your new Polk home theater system includes the latest technologies to assure outstanding performance and enjoyment. While we designed the RM Digital Solution system to be very easy to set up and use, please read this manual thoroughly for information on getting the greatest enjoyment from your new system.

Designing high quality audio products is more than just a business for the people of Polk Audio—it is our passion. We are all dedicated to your complete satisfaction and delight.

Should you have any problem or question regarding this or any Polk Audio product, consult your Polk Audio dealer or call our Customer Service Department at 1-800-377-7655 from 9am to 6pm, Eastern Time, Monday through Friday.

Sincerely,

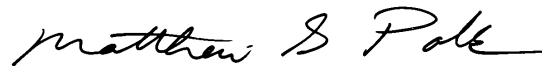

Matthew S. Polk



About Polk Audio—A History of Excellence

Polk Audio was founded in 1972 by Matthew Polk and George Klopfer. Their dream was to make speakers with the performance of the world's best speakers, but at reasonable prices. Today, Polk Audio is still headquartered in Baltimore, Maryland, and is one of the world's largest manufacturers of loudspeakers for home, office and car. Polk's research has yielded over 20 patents for advances in loudspeaker performance and value. Polk speakers have earned the praise of audio experts the world over, as well as dozens of awards for innovative, high-quality design. Polk Audio speakers are sold in over 50 countries and in audio/video specialist retail locations throughout the US.

SIMPLY COMPLETE HOME THEATER: THE RM DIGITAL SOLUTION

Even if you don't have the room for full-size home theater speakers, you still deserve great sound. This is the theory behind the development of "subwoofer/satellite" systems, whose coffee-cup-sized satellites can be placed conveniently and invisibly almost anywhere. These systems produce remarkable sound for their size, but even the best "sub/sat" systems have never quite equaled the performance of full-size speakers.

Knowing this, we set out to develop the ultimate "sub/sat" system.

PERFORMANCE
CONVENIENCE
SIMPLICITY

One with the convenience of a "sub/sat" system, and the performance you expect from Polk Audio.

Ultimately, we found that the only way to achieve our goal was to design not only the speaker system but the preamp, surround processor, and amplifiers as well.

By *optimizing* the speakers and electronics for each other we achieved a much higher level of performance than any previous sub/sat system!

When we were finished, we found we had created something entirely new: a no-compromise sub/sat surround system with all of the electronics for a high-performance Dolby Digital home theatre—integrated into a single, complete system.

We call it the RM Digital Solution: "An Intelligent A/V Pre-amp Processor and High Performance Loudspeaker System." With the RMDS-1, you have everything you need—except sources. There's no need to choose a receiver or separate surround processor or multi-channel power amplifier. With the RMDS-1 you already have them. *They're built-in.* And, most importantly, you know that they were designed specifically for each other to deliver no-compromise performance.

You don't need an advanced degree in digital electronics to get the most out of this system. We've done the work for you. The RMDS-1 is a complete system. Everything is pre-optimized to achieve

the best possible performance. No complicated setup procedures are required.

Simply plug everything in, and enjoy!



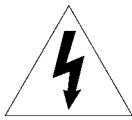

**RISK OF ELECTRIC SHOCK
DO NOT OPEN**



**CAUTION: TO REDUCE THE RISK OF ELECTRIC SHOCK,
DO NOT REMOVE COVER (OR BACK)
NO USER-SERVICEABLE PARTS INSIDE
REFER SERVICING TO QUALIFIED SERVICE PERSONNEL**



The lightning flash with arrowhead symbol, within an equilateral triangle, is intended to alert the user to the presence of uninsulated "dangerous voltage" within the product's enclosure that may be of sufficient magnitude to constitute a risk of electric shock to persons.



The exclamation point within an equilateral triangle is intended to alert the user to the presence of important operating and maintenance (servicing) instructions in the literature accompanying the appliance.

WARNING

**TO REDUCE THE RISK OF FIRE OR ELECTRIC SHOCK,
DO NOT EXPOSE THIS APPLIANCE TO RAIN OR MOISTURE.**

**CAUTION: TO PREVENT ELECTRIC SHOCK, MATCH WIDE
BLADE OF PLUG TO WIDE SLOT, FULLY INSERT.**

**ATTENTION: POUR ÉVITER LES CHOCs ÉLECTRIQUES,
INTRODUIRE LA LAME LA PLUS LARGE DE LA
FICHE DANS LA BORNE CORRESPONDANTE DE LA
PRISE ET POUSSER JUSQU'AU FOND.**

NOTE TO CATV SYSTEM INSTALLER:

This reminder is provided to call the CATV (Cable-TV) system installer's attention to Article 820-40 of the NEC, that provides guidelines for proper grounding and, in particular, specified that the cable ground shall be connected to the grounding system of the building, as close to the point of cable entry as practical.

NOTE:

This equipment has been tested and found to comply with the limits for a Class B digital device, pursuant to Part 15 of the FCC Rules. These limits are designed to provide reasonable protection against harmful interference in a residential installation. This equipment generates, uses and can radiate radio frequency energy and, if not installed and used in accordance with the instructions, may cause harmful interference to radio communications. However, there is no guarantee that interference will not occur in a particular installation.

If this equipment does cause harmful interference to radio or television reception, which can be determined by tuning the equipment off and on, the user is encouraged to try to correct the interference by one or more of the following measures:

- Reorient or relocate the receiving antenna.
- Increase the separation between the equipment and receiver.
- Connect the equipment into an outlet on a circuit different from that to which the receiver is connected.
- Consult the dealer or an experienced radio/TV technician for help.

NOTE:

Changes or modifications may cause this unit to fail to comply with Part 15 of the FCC Rules and may void the user's authority to operate the equipment.

IMPORTANT SAFETY INSTRUCTIONS READ BEFORE OPERATING EQUIPMENT

These products were designed and manufactured to meet strict quality and safety standards. There are, however, some installation and operation precautions which you should be particularly aware of.

1. Read Instructions-All the safety and operating instructions should be read before the system is operated.
2. Retain Instructions-The safety and operating instructions should be retained for future reference.
3. Heed Warnings-All warnings on the appliances and in the operating instructions should be adhered to.
4. Follow Instructions-All operating and use instructions should be followed.
5. Cleaning-Unplug the appliances from wall outlets before cleaning. Do not use liquid cleaners or aerosol cleaners. Use a damp cloth for cleaning.
6. Attachments-Do not use attachments not recommended by the product manufacturer as they may cause hazards.
7. Water and Moisture-Do not use these appliances near water-for example, near a bath tub, wash bowl, kitchen sink, or laundry tub, in a wet basement, or near a swimming pool, and the like.

8. Accessories-Do not place these appliances on an unstable cart, stand, tripod, bracket, or table. The audio/video products may fall, causing serious injury to a child or adult, and serious damage to the products. Use only with a cart, stand, tripod, bracket, or table recommended by the manufacturer, or sold with the appliances. Any mounting of the appliances should follow the manufacturer's instructions, and should use mounting accessories recommended by the manufacturer.

9. Ventilation-Slots and openings in the cabinet are provided for ventilation and to ensure reliable operation of the appliances and to protect them from overheating, and these openings must not be blocked or covered. The openings should never be blocked by placing the products on a bed, sofa, rug, or other similar surface. These products should never be placed near or over a radiator or heat register. These products should not be placed in a built-in installation such as a bookcase or rack unless proper ventilation is provided or the manufacturer's instructions have been adhered to.

10. Power Sources-These products should be operated only from the type of power source indicated on the marking labels. If you are not sure of the type of power supply to your home, consult your appliance dealer or local power company. For video products intended to operate from battery power, or other sources, refer to the operating instructions.

11. Grounding or Polarization-These products are equipped with polarized alternating-current line plugs (plugs having one blade wider than the other). This plug will fit into the power outlet only one way. This is a safety feature. If you are unable to insert the plug fully into the outlet, try reversing the plug. If the plug should still fail to fit, contact your electrician to replace your obsolete outlet. Do not defeat the safety purpose of the polarized plug.

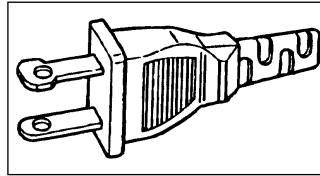

12. Power-Cord Protection-Power-supply cords should be routed so that they are not likely to be walked on or pinched by items placed upon or against them, paying particular attention to cords at plugs, convenience receptacles, and the point where they exit from the appliances.

13. Outdoor Antenna Grounding-If an outside antenna or cable system is connected to the product, be sure the antenna or cable system is

grounded so as to provide some protection against voltage surges and built up static charges. Section 810 of the National Electrical Code, ANSI/NFPA No. 70-1984, provides information with respect to proper grounding of the mast and supporting structure, grounding of the lead-in wire to an antenna discharge unit, size of grounding conductors, location of antenna-discharge unit, connection to grounding electrodes, and requirements for the grounding electrode. [\[See Figure 1.\]](#)

14. Lightning-For added protection for these audio/video products during a lightning storm, or when they are left unattended and unused for long periods of time, unplug them from the wall outlet and disconnect the antenna or cable system. This will prevent damage to the products due to lightning and power-line surges.

15. Power Lines-An outside antenna system should not be located in the vicinity of overhead power lines or other electric light or power circuits, or where it can fall into such power lines or circuits. When installing an outside antenna system, extreme care should be taken to keep from touching such power lines or circuits as contact with them might be fatal.

16. Overloading-Do not overload wall outlets and extension cords as this can result in a risk of fire or electric shock.

17. Object and Liquid Entry-Never push objects of any kind into these products through openings as they may touch dangerous voltage points or short-out parts that could result in a fire or electric shock. Never spill liquid of any kind on these audio/video products.

18. Servicing-Do not attempt to service these products yourself as opening or removing covers may expose you to dangerous voltage or other hazards. Refer all servicing to qualified service personnel.

19. Damage Requiring Service-Unplug these products from wall outlets and refer servicing to qualified service personnel under the following conditions:

- a. When the power-supply cord or plug is damaged.
 - b. If liquid has been spilled, or objects have fallen into the products
 - c. If the products have been exposed to rain or water.
 - d. If the products do not operate normally by following the operating instructions. Adjust only those controls that are covered by the operating instructions as an improper adjustment of other controls may result in damage and will often require extensive work by a qualified technician to restore the product to its normal operation.
 - e. If the product has been dropped or the cabinet has been damaged.
 - f. When the product exhibits a distinct change in performance-this indicates a need for service.
20. Replacement Parts-When replacement parts are required, be sure the service technician has used replacement parts specified by the manufacturer or have the same characteristics as the original part. Unauthorized substitutions may result in fire, electric shock or other hazards.
21. Safety Check-Upon completion of any service or repairs to these products, ask the service technician to perform safety checks to determine that the products are in proper operating condition.
22. Carts and Stands-The appliances should be used only with a cart or stand that is recommended by the manufacturer.
23. An appliance and cart combination should be moved with care. Quick stops, excessive force, and uneven surfaces may cause the appliance and cart combination to overturn.

Figure 1.

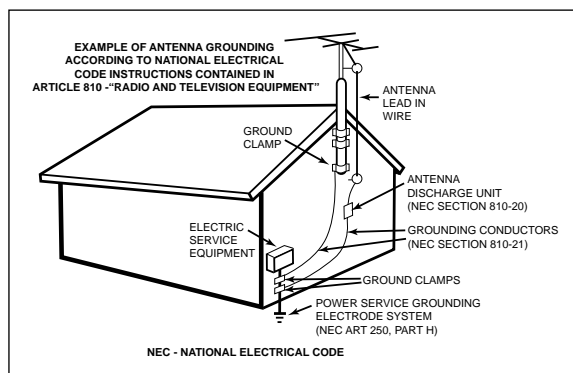

RMDS-1 FEATURES

- You want to enjoy a home theater system, not have it take over your home. The RMDS-1 features 5 compact satellite speakers that easily integrate into any room. They're easy to hide but look great when visible. You can even hang them on the wall with the supplied wall mount brackets. (Center brackets not supplied.)
- The RMDS-1 is a fully integrated and performance optimized system. That means all the parts were designed together for a single purpose: to bring you the highest performance satellite/subwoofer system in the world.
- Got a big room to fill? Not to worry. The RMDS-1 has a high power 6 channel power amplifier built right into the subwoofer enclosure. This is an honest-to-goodness, beefy high-end power amp with all the features that send audiophiles into rapture: high current, discrete circuits, dynamic headroom... But forget the jargon, this system plays loud and clean without strain even in large rooms.
- The RMDS-1 also includes one of the world's most sophisticated digital surround sound processors, which hooks up to the power amplifiers with a single convenient cable.
- Plug'n'Play – the preamp/processor is pre-configured for the speakers to bring you high performance right out of the box, without the need for complicated set-up procedures.
- The perfectly matched front, rear, and center speakers ensure seamless blending and lifelike surround sound effects. You'll feel like you are part of the action rather than a distant observer.
- Home theater is a group experience. The RMDS-1 speakers were designed to deliver broad, even dispersion of full-response sound throughout the room. Everyone hears clean, clear dialog music and sound effects.
- Some CDs have too much bass, some have too little. The same is true for movies. Most people like to adjust bass volume from CD to CD, movie to movie. We put the subwoofer volume control on the remote to make it easy for you to get the right amount of bass without leaving your chair.
- Half of the world is looking for the meaning of life. The other half is looking for better bass. (This is as good as humor gets in the audio business.) If you are part of the latter group, we've got the subwoofer for you. The RMDS-1 subwoofer uses our patented Power Port bass venting system to deliver deep, powerful bass with low distortion. Your friends will be green with envy.
- Most folks like more bass on movies than music. With the RMDS-1, once you have set subwoofer level for each surround mode, the system remembers and returns to that setting. We call this feature subwoofer/source memory. If you are watching a DVD and you select a bass level of -7, then switch to a CD in stereo and change the bass setting to -10, the system will return to a bass setting of -7 when you go back to the surround mode. We love this feature. We think you will too.
- Simple, intuitive operation. Everyone in the house, from kids to grandparents, can enjoy ultra high-performance home theater entertainment without reading this dopey manual.
- You have lots of potential entertainment sources. The RMDS-1 has enough analog and digital audio inputs to hook up any source – DVD, Laserdisc, VCR, DSS, Tape, CD, Camcorder, and Cable TV.
- The RMDS-1 has three digital inputs, including an RF input, for laserdisc players with an AC-3 RF output, plus two other digital inputs for a DVD player and the latest Dolby Digital capable satellite TV (DSS) receivers.
- The RMDS-1 comes with audiophile-grade cables with gold plated connectors for hooking up all the parts of the RMDS-1 system.
- Is picture quality as important to you as the quality of sound? You're going to appreciate that the RMDS-1 offers S Video inputs and outputs in addition to standard composite video. S video cables provide better picture detail than conventional video cables.
- Would you like music in another room? No problem. The RMDS-1 has independent Multi-Room stereo pre-amp outputs that allow you to hear one source in a remote room while a *different source* is playing in the main room. (Requires optional external stereo integrated amplifier and speakers for the second zone.)

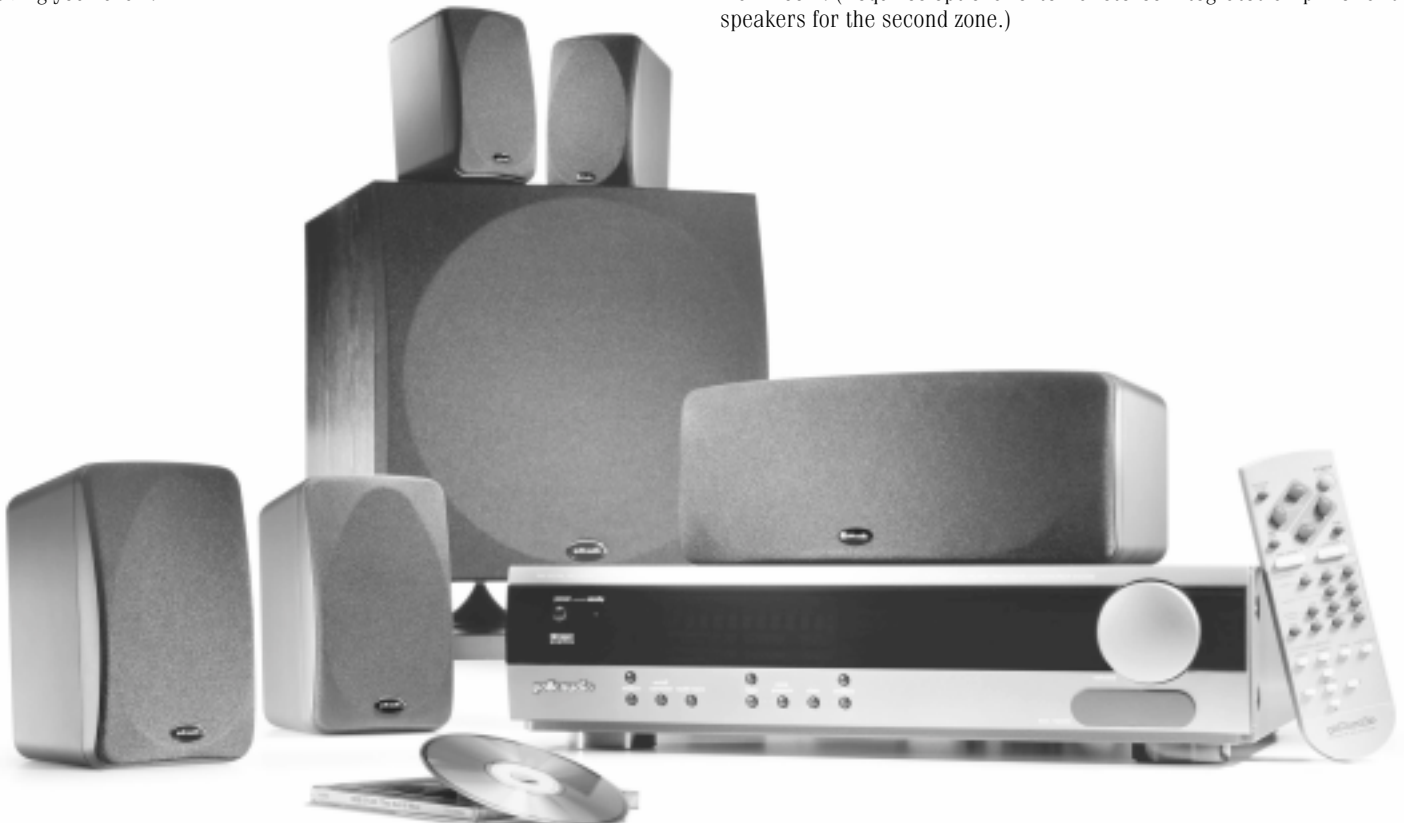

GETTING STARTED

Carton Contents

Your new Polk Audio RM Digital Solution system comes in two cartons. If you do not have any of the pieces listed below, or if any component seems damaged, contact your Polk Audio retailer immediately.

Carton 1:

One (1) RMDS-1 Preamp/Processor
One (1) Infrared remote control
Two (2) AA batteries for remote
Four (4) RM front and surround satellite speakers
One (1) RM center channel satellite speaker
Four (4) satellite wall-mount brackets with screws
Twenty (20) adhesive-backed rubber pads
Three (3) 20' (6M) speaker cables
Two (2) 40' (12M) speaker cables
One (1) 4 Meter DB-25 interconnect cable
One (1) 4 Meter DB-25 interconnect cable
One (1) FM antenna wire
One (1) AM loop antenna

Carton 2:

One (1) RMDS-1 subwoofer with integrated 6 channel power amplifier
One (1) IEC-type AC power cable

Quick Start Guide (see illustrations on pages 8 and 9)

1. Remove all of the components and accessories from the shipping cartons.
2. Connect sources such as DVD player, VCR, etc. to the RMDS-1 audio and video inputs using coaxial (RCA-type) cables.
3. Connect the video output of the RMDS-1 preamp/processor to a video input on your TV.
4. Connect the RMDS-1 to the subwoofer with the supplied 4 meter DB-25 cable.
5. Using the supplied speaker wires, connect the speakers to the speaker terminals on the back of the subwoofer. Be sure to maintain correct polarity (+ to +, - to -) on all channels. The wire with the black band should always be connected to the black (-) terminal and the wire with the color band should always be connected to the red (+) terminal.
6. Plug the AC cord that was in the subwoofer box into the AC receptacle on the subwoofer.
7. Plug the AC cords from the preamp/processor and subwoofer into 120V/60 Hz AC power outlets.
8. Turn the power switch on the subwoofer to the "Standby" position.
9. Press the power button on the preamp/processor front panel or remote control.
10. Select the input of your choice.
11. Set volume and bass level to taste and enjoy!

BASIC SETUP

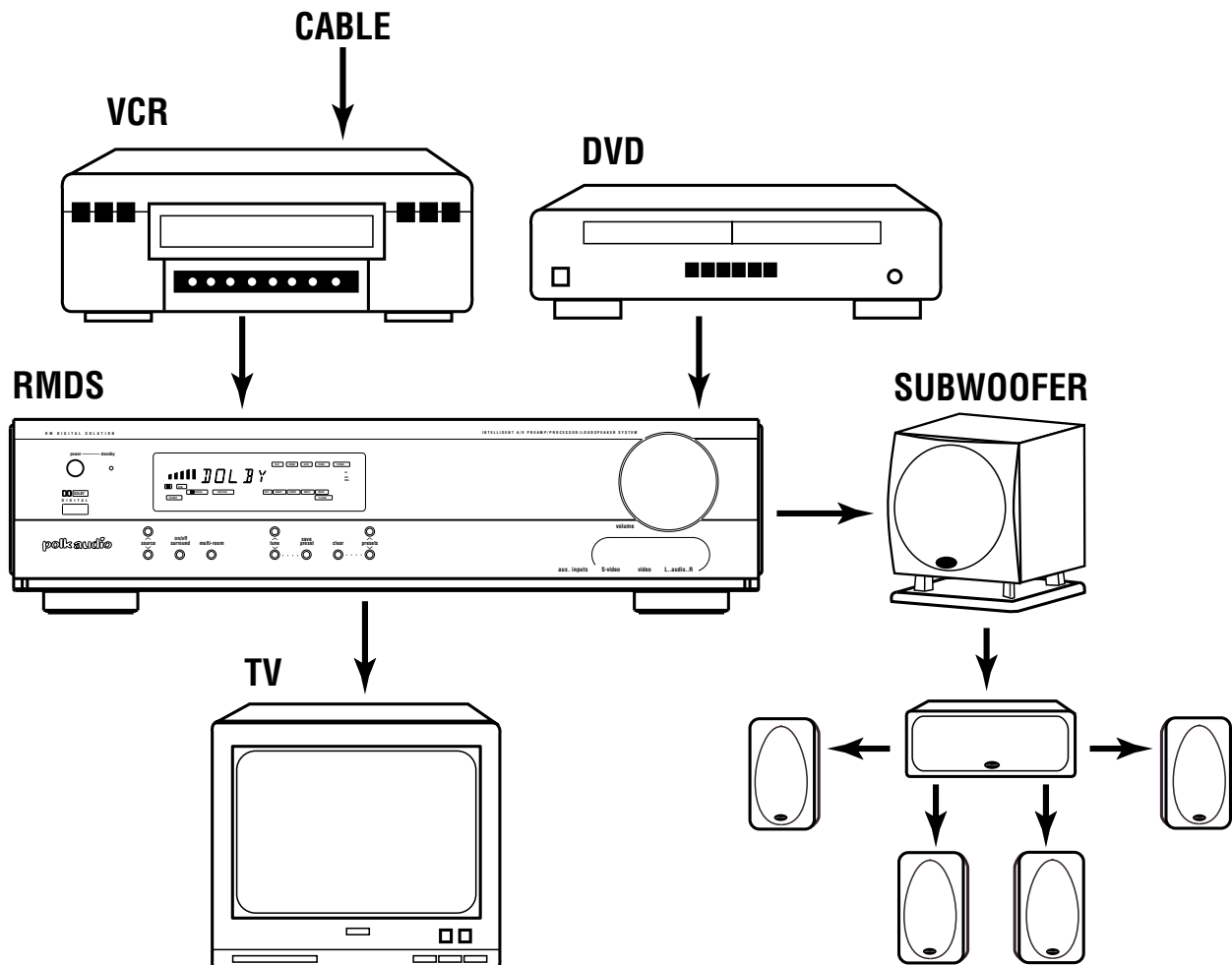

REAR PANEL GUIDED TOUR

Area A - Antenna Connections

This is where you hook up indoor or outdoor antennas for AM and FM radio reception.

Area B - Audio Analog Inputs/Outputs

This is where connections are made for the analog audio outputs of sources such as CD player, DVD player, tape deck, etc. It is a good idea to connect the analog outputs of all sources, even sources such as DVD and Laserdisc players that have digital audio connections. Doing so allows the use of digital sources for multi-room sound.

Area C - Multi-Room Outputs

These jacks allow you to use the sources (CD player, tape deck, etc.) connected to the RMDS-1 as sources of sound in another room. See the section on "Using Multi Room" on page 25 of this manual.

Area D - Video Inputs/Outputs

These jacks are used to feed the video signals of video players such as VCR and DVD into the preamp/processor and then out to your TV. This allows you to switch audio and video at the same time. For example, when you want to switch from watching the VCR to watching the DVD, you only have to push one button on the RMDS-1 remote instead of two (one to switch audio on the RMDS-1 remote and one to switch video on the TV remote).

There are two kinds of video jacks on the RMDS-1: standard "composite," and S-VHS (or S-video). If a video source and your TV have S video connectors, use them; you will get a picture with more detail. **IMPORTANT NOTE:** If you connect a video source to the RMDS-1 with an S-video cable, you must connect the TV to the RMDS-1 with an S-video cable, or you will not see the picture on your TV. See "Connection Precautions" on page 10.

Area E - Digital Inputs

This is where you connect sources with digital audio outputs, such as DVD, 12" Laserdisc, and digital DSS receivers.

IMPORTANT NOTE: The input jack labeled "LD RF" is for a Dolby Digital RF signal from a 12" Laserdisc player only. Do not connect a normal audio output terminal or the digital coaxial output of a DVD player or any other source to the "LD RF" jack. You will damage the RMDS-1 if you do.

Area F - Remote Control Extension jacks

These jacks are for potential future Polk Audio products. When we bring out other electronic products, these jacks will help you unify the remote control functions of the RMDS-1 and the new device.

Area G - Multi-pin Connectors

(on Preamp/Processor and Subwoofer)

These may look like connectors for computer printers, but they are not. This is the way the 6 channels of sound get from the preamp/processor to the 6 amplifiers that are built in to the subwoofer enclosure. We even supply the cable.

Area H - Speaker Connections

(on Subwoofer)

This is where you hook up the speakers to the built-in amplifiers.

Area I - AC Outlets

Connect the power cables of components such as a cassette deck and CD player to these outlets. The one marked UNSWITCHED is always live as long as The RMDS-1 is plugged into a live outlet. A component connected here may be left on permanently, or may be switched off with its own power switch. Caution: In order to avoid potential turn-off thumps, anything plugged in here should be turned on before the RMDS-1 is turned on.

The outlet marked SWITCHED only delivers power if the RMDS-1 is on. This is a good place to plug in any component that you want to turn on and off along with the RMDS-1 system. Check the AC power rating of the components you want to plug into these outlets. If either component draws more than 0.8 Amperes of current, do not use these outlets. Plug the component directly into a wall socket or power strip.

Area J - Subwoofer AC functions

(on Subwoofer)

Once everything else is hooked up, set the switch to the "Standby" position. If the system fails to function, disconnect the subwoofer's power cord from the AC outlet, remove and inspect the fuse. Replace with 7.5A Slow Blow 250V fuse only.

Area K - Pilot light

(on Subwoofer)

When the subwoofer is plugged in to a live AC outlet and the power switch (J) is set to "Standby" this light will glow red while the preamp/processor is "off," and green when the preamp processor is "on."

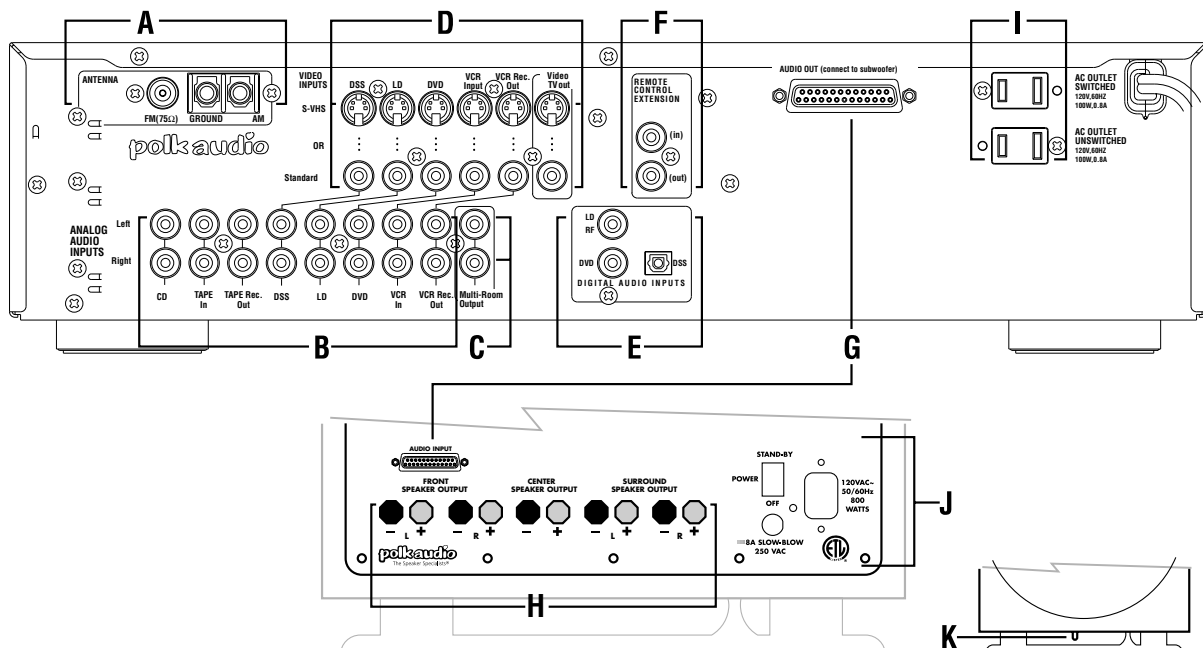

BASIC SYSTEM HOOK UP

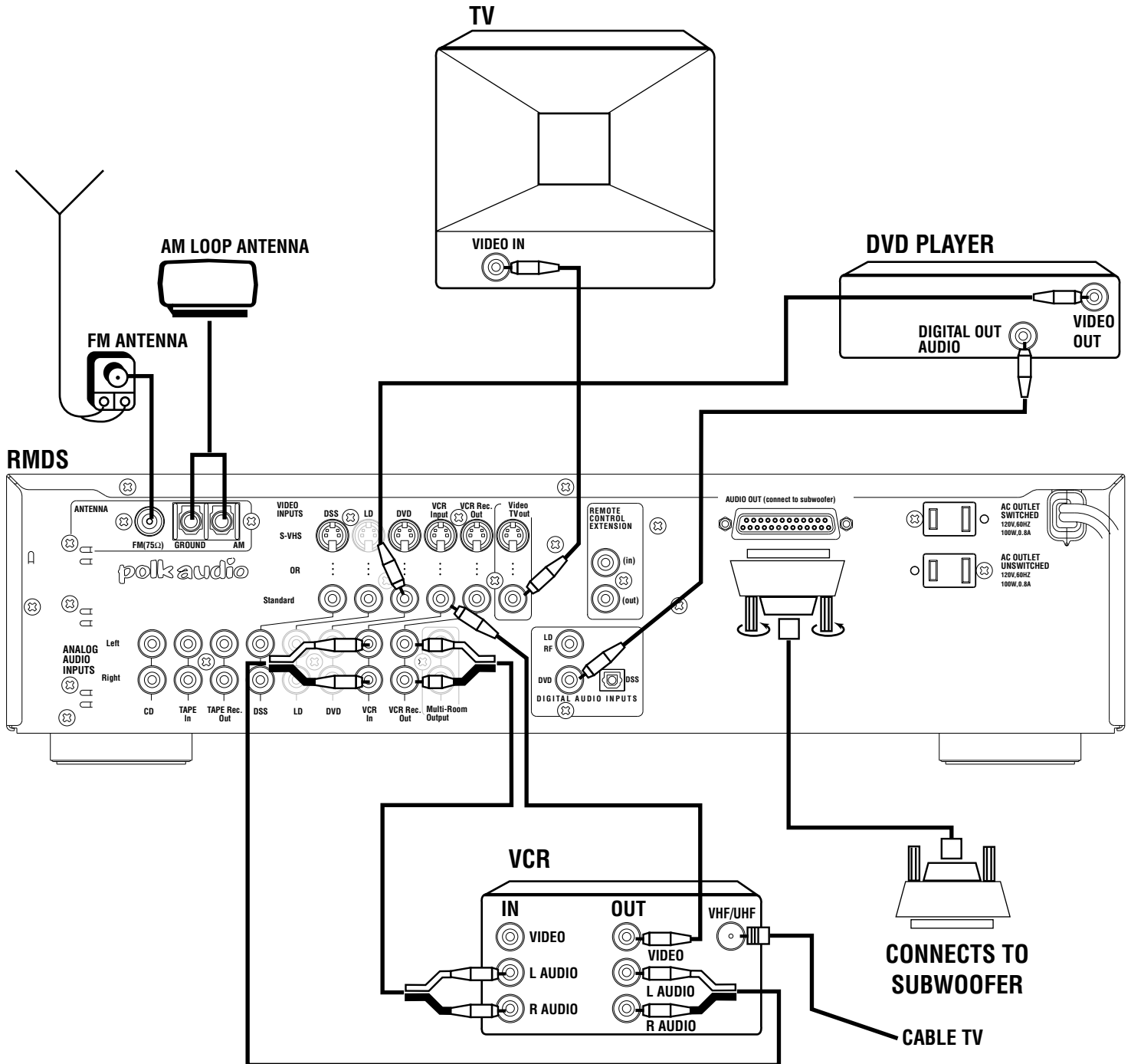

SPEAKER HOOK UP

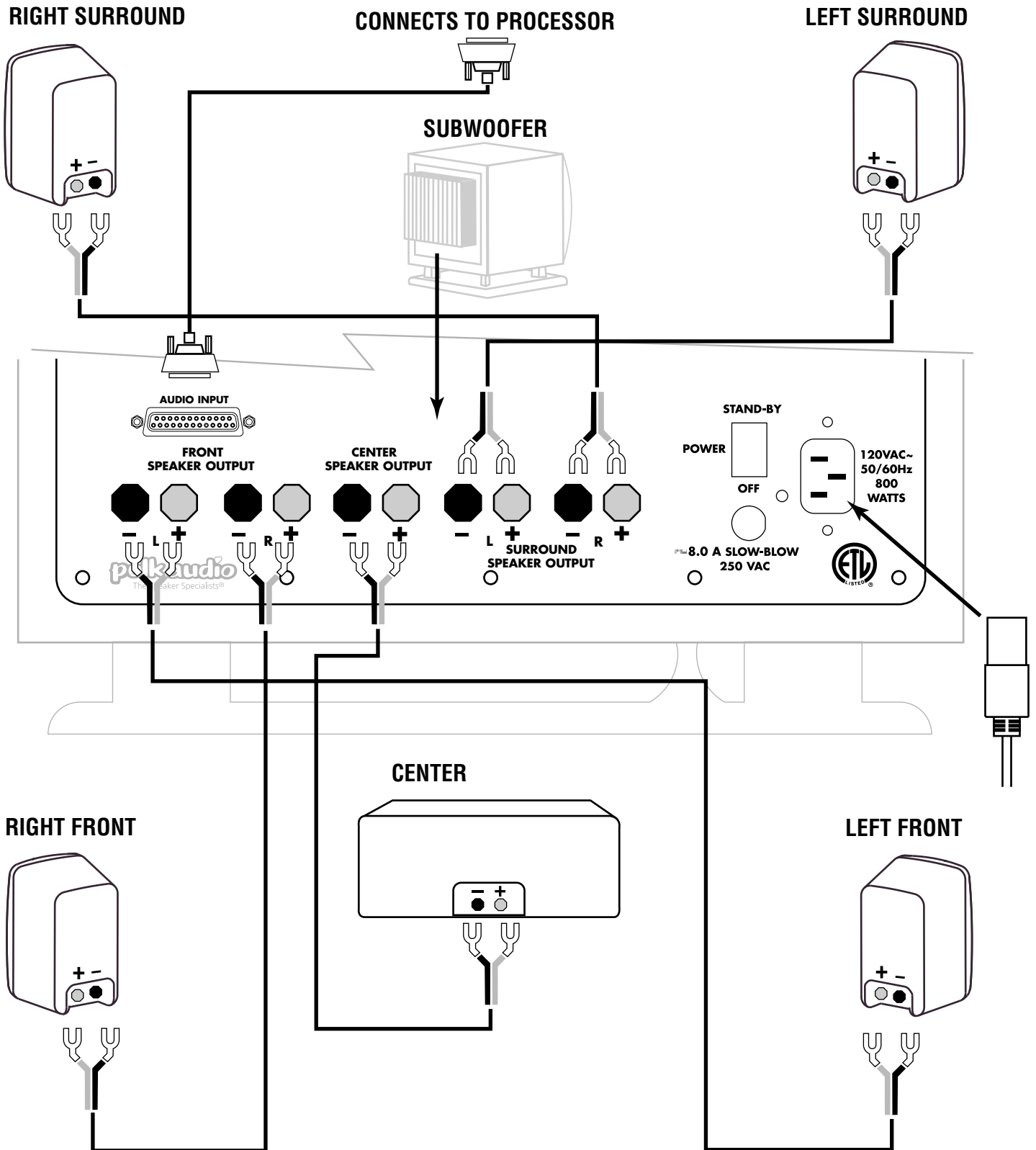

HOOKING UP THE SYSTEM

Connection Precautions

- Do not plug the preamp/processor or subwoofer into AC outlets until all the connections have been made.

- When connecting sources, use *either* standard composite (good) *or* S Video (better) throughout. Do not use both composite and S Video connections. Use the same type of connection between the RMDS-1 and your TV.

- Connect one cable at a time observing the "input" and "output." This will avoid any cross connection between channels and signal inputs and outputs.

- Insert the plugs securely. Incomplete connections may result in noise or signal loss.

- We've included high quality pre-cut and terminated speaker wire, and a 25-pin processor-subwoofer cable. To hook up your sources, we recommend the use of high quality audio and video connecting cables. See your Polk Audio dealer for specific recommendations.

- Prior to connecting other audio and video equipment to the RMDS-1, please read their owners' manuals.

Connecting Radio Antennas

Connect the supplied FM wire antenna to the FM (75 Ohm) F-type connector. For better reception connect an indoor or outdoor FM antenna.

The Polk RMDS-1 comes supplied with an AM loop antenna that connects to the GROUND and AM terminals as illustrated. To use those terminals, unscrew the tabs and insert the antenna's bare wires into the holes, then tighten the tabs. To find the best place to put the AM antenna, tune in a local AM radio station (see page 22) and move the AM loop antenna around until you get the clearest reception. You can secure the antenna to a wall or the inside wall of an equipment cabinet with screws.

Connecting a DVD Player

Connect the coaxial digital output of the DVD player to the DVD DIGITAL INPUT of the RMDS-1 preamp/processor. We recommend that you also connect the Left and Right analog outputs of the DVD player to the analog audio DVD inputs of the RMDS-1 using RCA connectors. This will allow you to tape record the audio output of the DVD player and use the DVD player as an audio source for a remote room.

Connect either the composite video or the S-video output of the DVD player to the corresponding DVD video input of the RMDS-1.

Do not use both composite and S-video connections. If you use S-video connections here, you must connect your TV to the RMDS-1 preamp/processor with an S-video cable in order to get a picture with this input. If your DVD player has "component" video outputs (three jacks), you must connect those directly to a TV that has corresponding "component" video inputs.

A very few DVD players do not have a coaxial (RCA type) digital output but only an optical cable output. In that case, hook up the DVD player into the DSS optical digital and analog audio and video inputs. Select "DSS" when you want to use your DVD player.

OPTION: If the DVD player is also being used as a CD player and there is no other CD player in the system, you may want to plug the analog audio outputs of the DVD player into the analog CD inputs rather than the analog DVD inputs. This allows you to set one bass level for stereo and another bass level for surround. When you play a CD in the DVD player, push the CD button on the remote and you will hear the CD with the amount of bass you previously selected. When you play a DVD movie, push the DVD button on the remote and you'll automatically hear the DVD with the bass level set to another previously set level (generally higher). The one downside of this hook-up is that you will not be able to record DVD movies to your VCR. That is copyright infringement and you shouldn't be doing it anyway. Don't you read those FBI warnings at

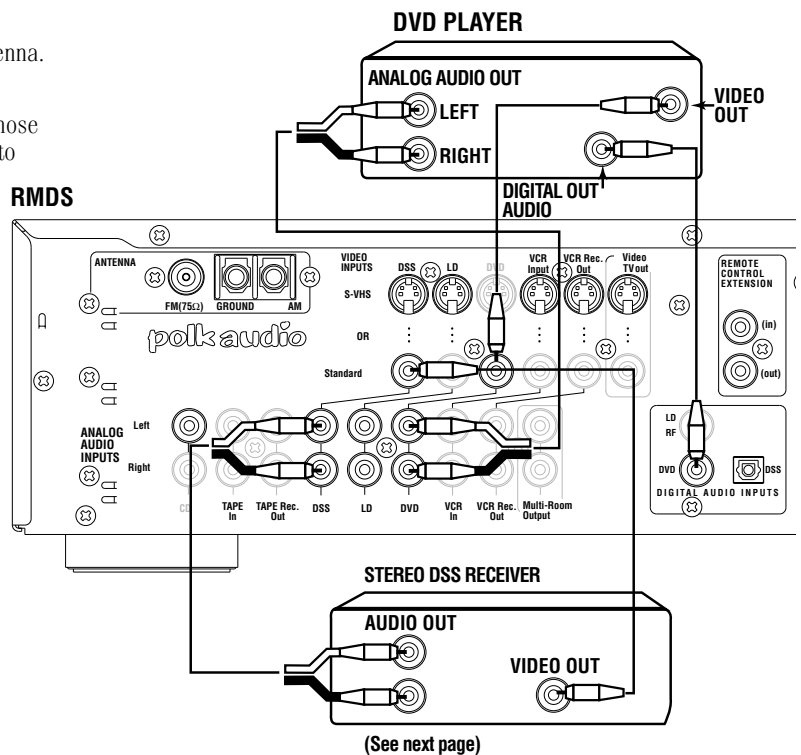
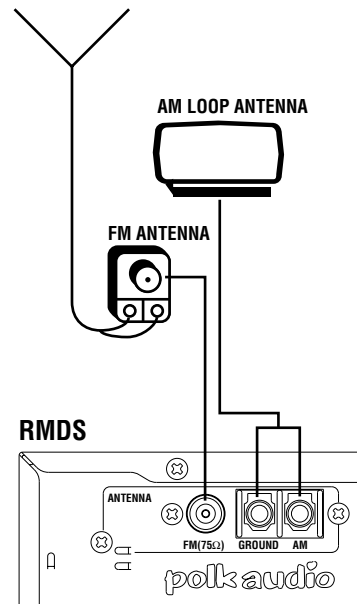

Connecting a Stereo DSS (satellite TV) Receiver (see diagram on previous page)

The first generation of DSS receivers (pre 1999) only have stereo analog audio outputs and are not capable of delivering 5.1 channel digital surround sound. If your DSS receiver box only has Left and Right audio jacks and no jack marked "Digital Out" or "PCM Out," use this hook up method. DSS receivers made in 1999 or later with a "Digital Out," "Optical," "TOS Link," or "PCM Out" jack should be connected as described in "Connecting a Digital DSS Receiver" below. If you have any doubts as to which type of DSS receiver you have, contact your DSS dealer.

For Stereo DSS, connect the left and right audio outputs of the DSS receiver to the Left and Right DSS inputs on the RMDS-1 preamp/processor. Connect either the composite video or the S-video output of the DSS receiver to the corresponding DSS video input of the RMDS-1. Do not use both composite and S-video connections. If you use S-video connections here, you must connect your TV to the RMDS-1 preamp/processor with an S-video cable in order to get a picture with this input.

Connecting an Digital DSS (satellite TV) Receiver

Connect the optical digital output of the DSS receiver to the DSS DIGITAL INPUT of the RMDS-1 using a TOS LINK fiber-optic cable available at your Polk Audio dealer. We also recommend connecting left and right analog audio outputs of the DSS receiver to the Left and Right DSS inputs on the RMDS-1 preamp/processor. This will allow you to record the audio output of the DSS on to a VCR.

If your DSS receiver does not have an optical digital output jack, connect your DSS receiver to the DVD inputs as described in "Connecting a DVD Player." You will then connect your DVD player to the DSS inputs (almost all DVD players have an optical output).

Connect either the composite video or the S-video output of the DSS receiver to the corresponding DSS video input of the RMDS-1. Do not use both composite and S-video connections. If you use S-video connections here, you must connect your TV to the RMDS-1 preamp/processor with an S-video cable in order to get a picture with this input.

Connecting a VCR

Connect the Left and Right audio outputs of the VCR to the Left and Right analog audio VCR In jacks of the RMDS-1. Connect the Left and Right audio inputs of the VCR to the Left and Right VCR Rec. Out jacks of the RMDS-1.

Connect either the composite video or the S-video output of the VCR to the corresponding VCR video input of the RMDS-1. Do not use both composite and S-video connections. If you use S-video connections here, you must connect your TV to the RMDS-1 preamp/processor with an S-video cable in order to get a picture with this input.

Connecting a CD Player

Connect the analog stereo outputs of your CD player to the Left and Right CD inputs of the RMDS-1 preamp/processor.

Connecting an Audio Tape Deck

Connect the outputs of the tape deck to the TAPE IN jacks of the RMDS-1. Connect the inputs of the tape deck to the TAPE Rec. Out jacks of the RMDS-1.

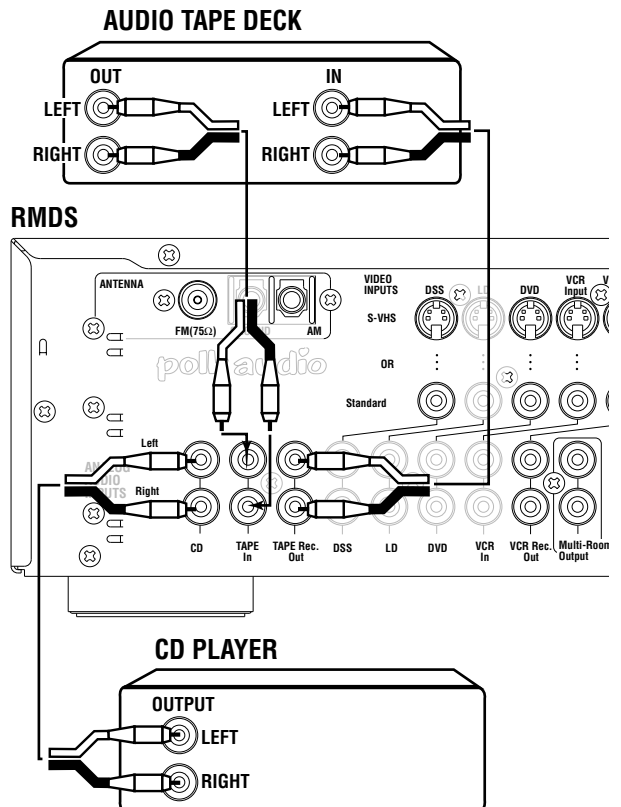
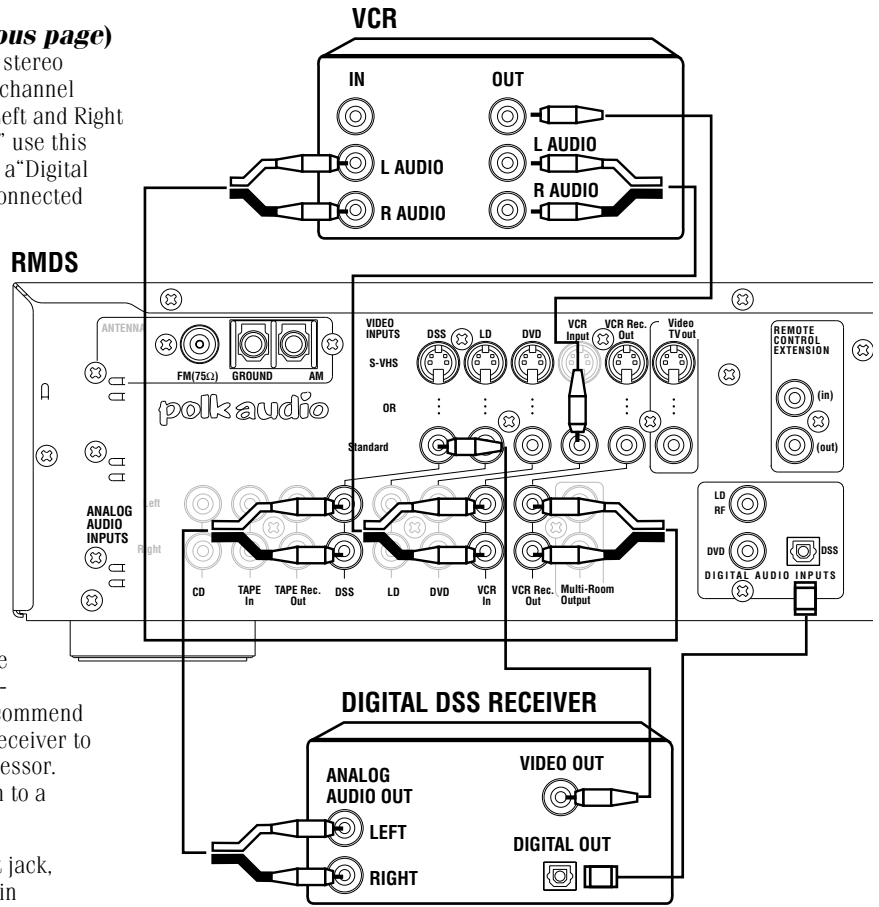

Connecting a Laserdisc Player

Connect the AC-3 RF output of the LD player LD RF input of the RMDS-1.

IMPORTANT NOTE: Do not connect a normal analog audio output or digital coaxial output of a DVD player or any other source to the LD RF jack. You will damage the RMDS-1 if you do.

Also connect the left and right analog audio outputs of the LD player to the Left and Right LD analog inputs on the RMDS-1 preamp/processor. This will allow you to hear laser discs that do not have Dolby Digital AC-3 soundtracks.

Early LD players only have analog audio outputs and are not capable of delivering 5.1 channel Dolby Digital surround sound. If your LD player does not have a jack marked "RF AC-3 Out," just hook up the Left and Right analog audio outputs of the LD player to the analog LD inputs on the RMDS-1 preamp/processor. If you have any doubts as to whether your LD player has a Dolby Digital (AC-3) RF output, contact your Polk Audio dealer.

Connect either the composite video or the S-video output of the LD player to the corresponding LD video input of the RMDS-1. *Do not use both composite and S-video connections.* If you use S-video connections here, you must connect your TV to the RMDS-1 preamp/processor with an S-video cable in order to get a picture with this input.

Connecting Your TV to the RMDS-1 Preamp/Processor

If you are using only standard (composite RCA) video inputs for your video sources and no S-video sources, just connect the VIDEO TV out to any free composite video input of your TV. If you are using only S-VHS (S-Video) video inputs for your video sources and no standard (composite) sources, just connect the VIDEO TV out to any free S-video input of your TV.

If you want the audio from your TV to play through the system, just connect its audio outputs to any unused set of analog input jacks on the RMDS-1, such as LD, AUX (on the front panel), or Tape In.

Connecting the Preamp/Processor to the Subwoofer

Use the supplied 4 meter (13.25') 25-pin audio cable to connect the AUDIO OUT of the RMDS-1 preamp/processor to the AUDIO IN 25-pin connector on the subwoofer. **IMPORTANT NOTE:** If the cable is not long enough, you may add a 4 meter Monster Cable brand DB25HT Audio Interconnect cable (or equivalent) to increase the length to 8 meters. Contact your Polk dealer or call Polk Audio (800) 638-7276, ext. 324, Monday through Friday, Eastern Standard Time, to order an extension cable. **MORE IMPORTANT NOTE:** While the 25-pin connector cable may look like your average computer printer cable, it is *not* a printer cable. Do not try to use a computer printer cable to connect your RMDS-1 system. This will damage your RMDS-1. And you still won't be able to print out that important report through your subwoofer.

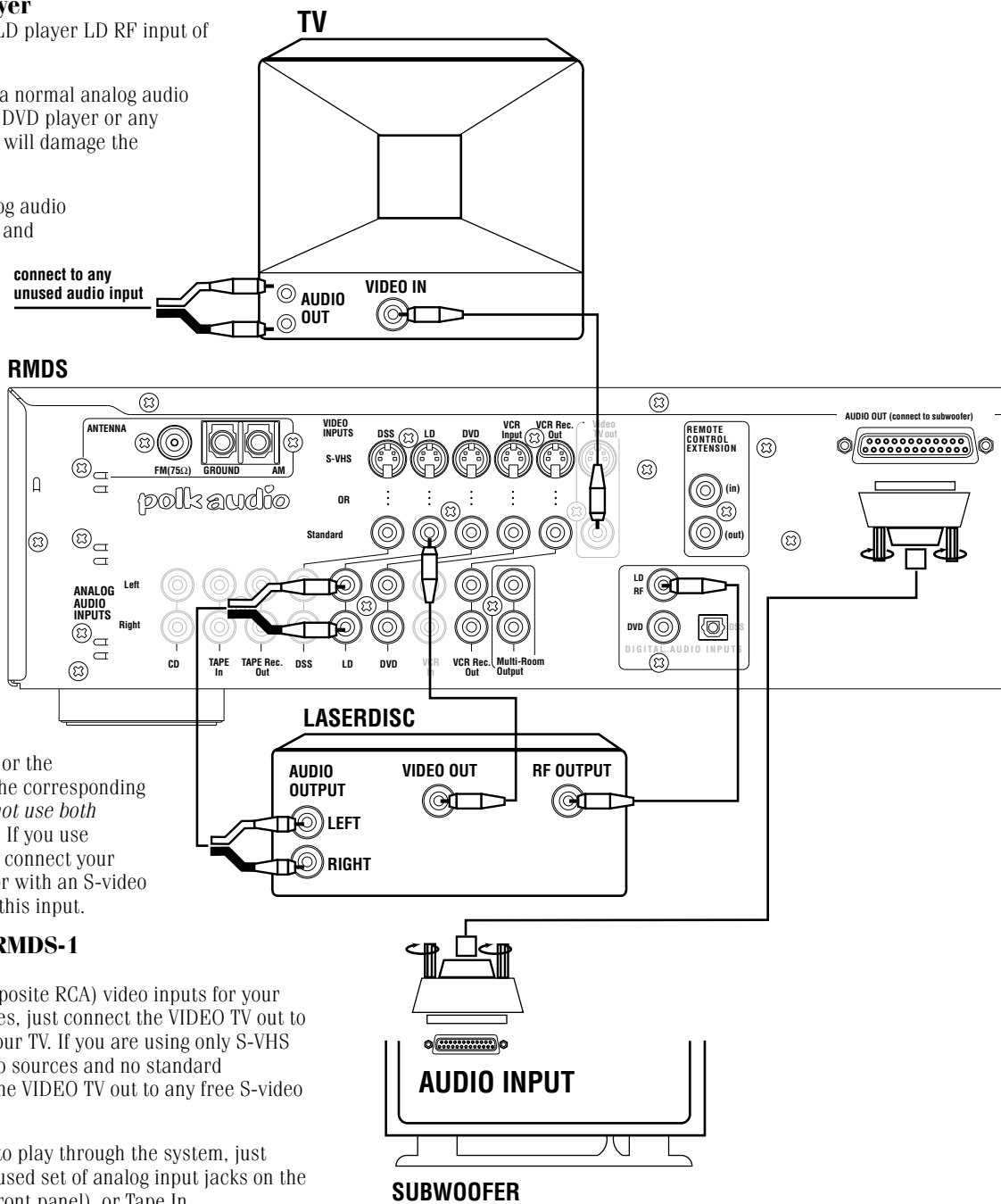

Connecting the Speakers

We have supplied you with 5 sets of audiophile-grade speaker wire to connect your speakers. Each wire is color coded just to make it easy for you to see which wire is which at the subwoofer (amplifier) side. You can use any wire on any channel. Use whatever length makes sense for your set up and speaker placement. You can temporarily (and safely) rest the subwoofer on the grille-end to make it easy to see the terminals and connect the wires.

IMPORTANT NOTE: The speaker wire may impede the satellite speaker from sitting flat on a surface. To correct this problem, gently bend the wire just below the spade-lug connector as illustrated in Figure 2.

Front L&R Speakers

Use one of the supplied 20' (6M) speaker wires to connect the Left satellite speaker to the Left Front speaker output on the subwoofer amplifier. One conductor of the speaker wire is marked with a color insulator. Use that conductor to connect the red (+) terminal of the speaker to the red (+) Left Front speaker terminal on the subwoofer amplifier. Use the speaker wire conductor with a black insulator to connect the black (-) terminal of the satellite speaker to the black (-) terminal on the subwoofer amplifier. To get a secure connection, loosen the 5-way binding post thumb nuts far enough to slip the spade lug connectors under the thumb nuts (Fig. 1). Tighten the thumb nut by hand or with a 3/8" nut driver. **DO NOT OVER TIGHTEN.** Repeat for the Right Front channel satellite speaker.

Center Speaker

Follow the same procedure described above to connect the center speaker to the Center Speaker outputs on the subwoofer amplifier.

Surround L&R Speakers

Follow the same procedure described above to connect the rear surround speakers to the Left Surround and Right Surround speaker outputs on the subwoofer amplifier. Use the 40' (12M) wires.

IMPORTANT NOTE: Be careful to maintain correct polarity on all the speakers by always using the speaker wire with the color insulator for the red (+) terminals and the black marked wire for the black (-) terminals **ON THE AMPLIFIER AND ALL THE SPEAKERS.** Failure to maintain correct polarity will result in poor sound quality. Double check all connections before using the system.

If the supplied speaker wire is not long enough, contact your Polk Audio retailer for more high quality speaker wire. Use only high quality 16 gauge or thicker speaker wire. *Do not use lamp cord.* Lamp cord is not speaker wire, and your satellites will not light up.

Connecting to AC Outlets

If you are completely finished connecting all your source components, your TV, and your speakers, now you can plug the system into household 110-120 V, 60 Hz AC power outlets. You must first connect the supplied AC power cord to the receptacle on the rear panel of the subwoofer. Locate the Power switch on the back of the subwoofer and set it to the "Standby" position. A small pilot light on the bottom, front side of the subwoofer will glow red indicating that the system amplifiers are plugged in and awaiting a turn-on "order" from the preamp/processor. When the preamp/processor is turned on, it will turn the amplifiers fully on and the pilot light will glow green. If you will be away from home for an extended period of time, turn the subwoofer power switch to "Off."

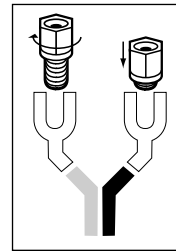
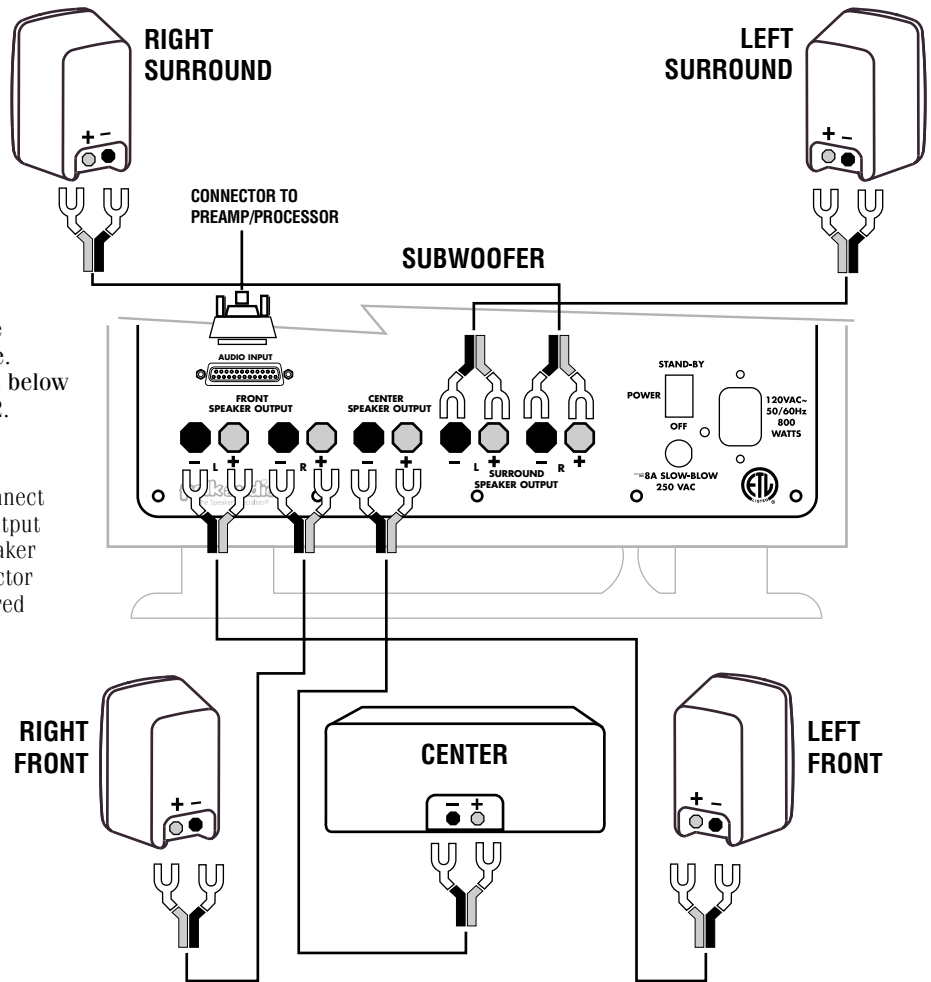

(Fig. 1)

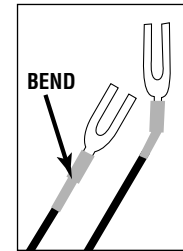

(Fig. 2)

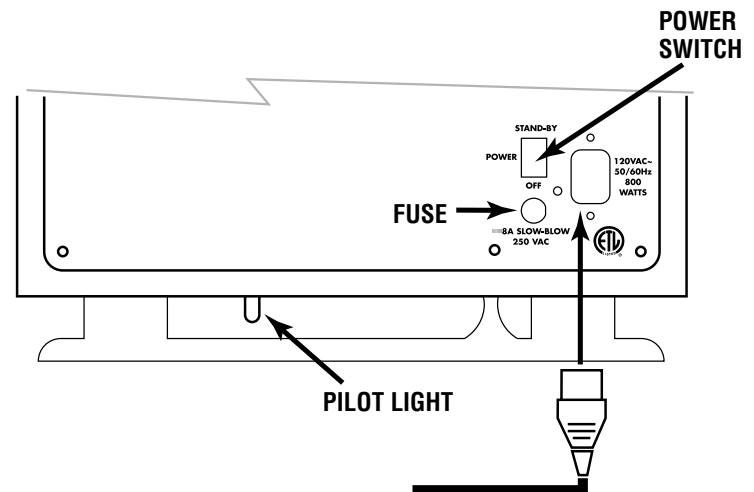

SPEAKER PLACEMENT

IMPORTANT NOTE:

When this manual refers to "Front Left," we mean the speaker on your left side as you face the front (TV) side of the room. When we refer to "Surround Left" we mean the speaker that is behind you and to your left as you face the front (TV) side of the room.

Center Channel Speaker

Place the center speaker as close to the TV as possible. The most popular placement is right on top of your TV set. It is also fine to place it below the TV or on the wall directly above the TV (using optional wall bracket).

Front Satellites

Place the front satellites about as far apart as you are sitting from them. Avoid placing them less than 2 feet from side walls. The vertical position should be at or near your ear level when seated. If you choose to wall mount them more than 2 feet above ear level, turn the wall bracket so that the bracket angles down (see bracket instructions on next page).

Surround Speakers

The best placement for surround channel speakers is on the side walls, facing each other and slightly behind your listening position. If this placement is not possible, the speakers may be placed on the rear wall. In either case, mount the speakers two to four feet above a seated listener's head.

Subwoofer

The magnetically shielded subwoofer may be placed in an entertainment center, behind furniture, or next to a sofa or chair. For best performance place it on the same side of the room as the front satellites and near a wall. It should only be seated on the plinth as illustrated. NEVER LAY THE SUBWOOFER ON THE AMPLIFIER END - THIS WILL DAMAGE THE AMPLIFIER.

If the 25-pin cable is not long enough, you may add a 4 meter Monster Cable brand DB25HT Audio Interconnect cable (or equivalent) to increase the length to 8 meters. Contact your Polk dealer or call Polk Audio (800) 638-7276, ext. 324, Monday through Friday, Eastern Standard Time to order an extension cable.

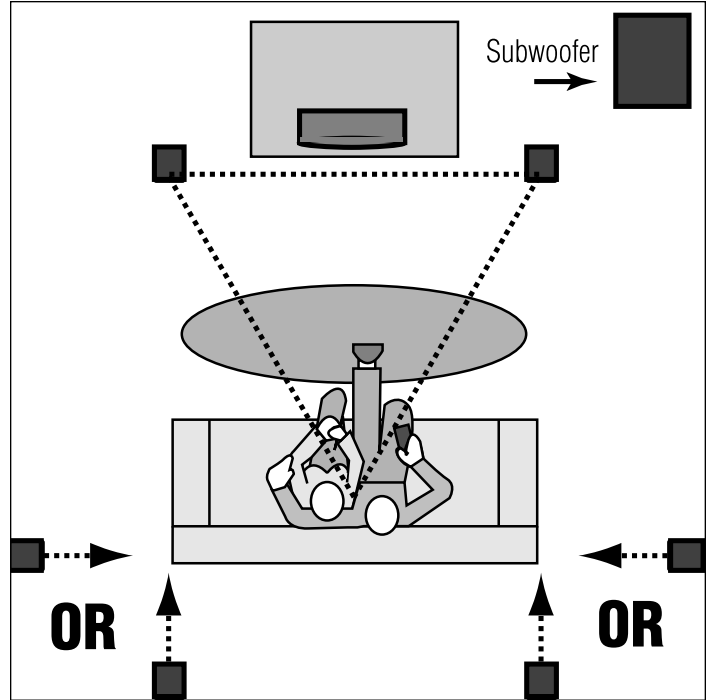

The RMDS-1 satellites and center channel speaker are designed only for use with this system. If they are hooked up to a regular receiver or amplifier, the speakers may be damaged.

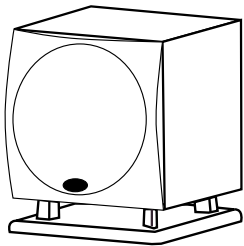

Wall Mounting The Satellites

The satellite speakers are supplied with wall mounting brackets. Follow the steps below to safely secure the brackets and speakers.

On-wall installation of RM satellites requires basic skills in using tools such as a drill and screwdriver. If you are in doubt that you possess the necessary skills or tools, consult your Polk dealer or a professional installer.

- Make sure the locations you select do not conceal electrical wiring or plumbing.
- Hold the speaker in the chosen location to make sure it clears the ceiling, adjacent walls, corners, beams, lighting fixtures and door/window frames.
- Use a bracket as a template to mark the location of the two key-hole slots with a pencil.
- If you are certain that there is a stud behind the wall surface, drive #10 screws (not supplied) through the wall and into the stud leaving screw heads protruding 1/16".
- If there is no stud behind the chosen location, install #10 wall anchors (not supplied) into the wall by following wall anchor manufacturer's instructions, leaving screw heads protruding 1/16". Always use two wall anchors and screws per speaker.
- Attach the bracket to the satellite with the supplied screw as shown. The angle of the bracket allows you to point the speaker toward your listening position. Turn the bracket to get the angle you want and tighten the screw.
- Line up speaker so that screw heads pass through the large center holes of the keyhole slots. Let speaker slide straight down, allowing screw heads to slip behind the smaller end of the keyhole slots.
- If the supplied wall mount brackets do not allow the mounting angle that meets your needs, or if you wish to ceiling-mount the satellites, use optional, fully articulating "ball and socket" mounting brackets, such as those made by Omnimount.

Center Channel Wall Or Ceiling Mounting

Use an optional, fully articulating "ball and socket" mounting bracket, such as those made by Omnimount.

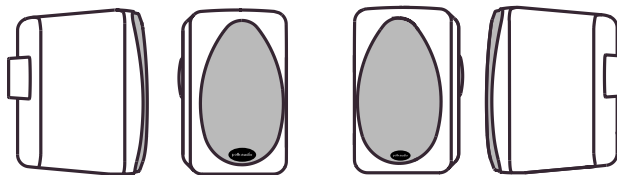
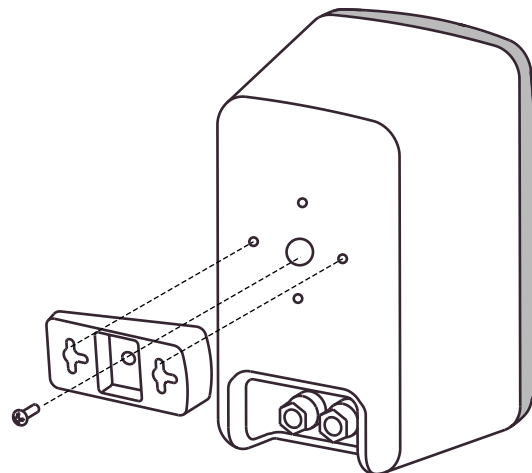
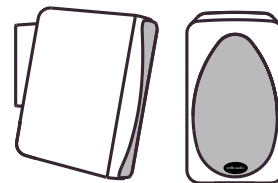
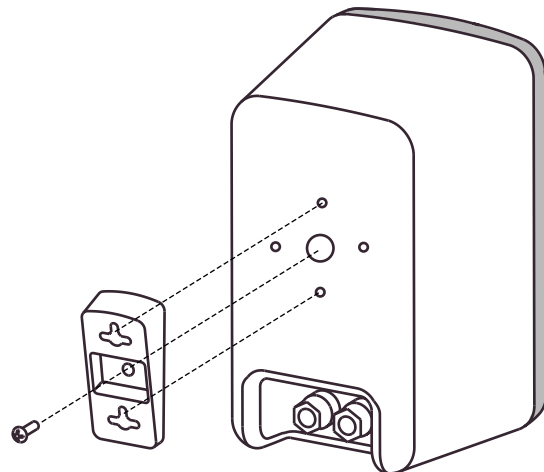

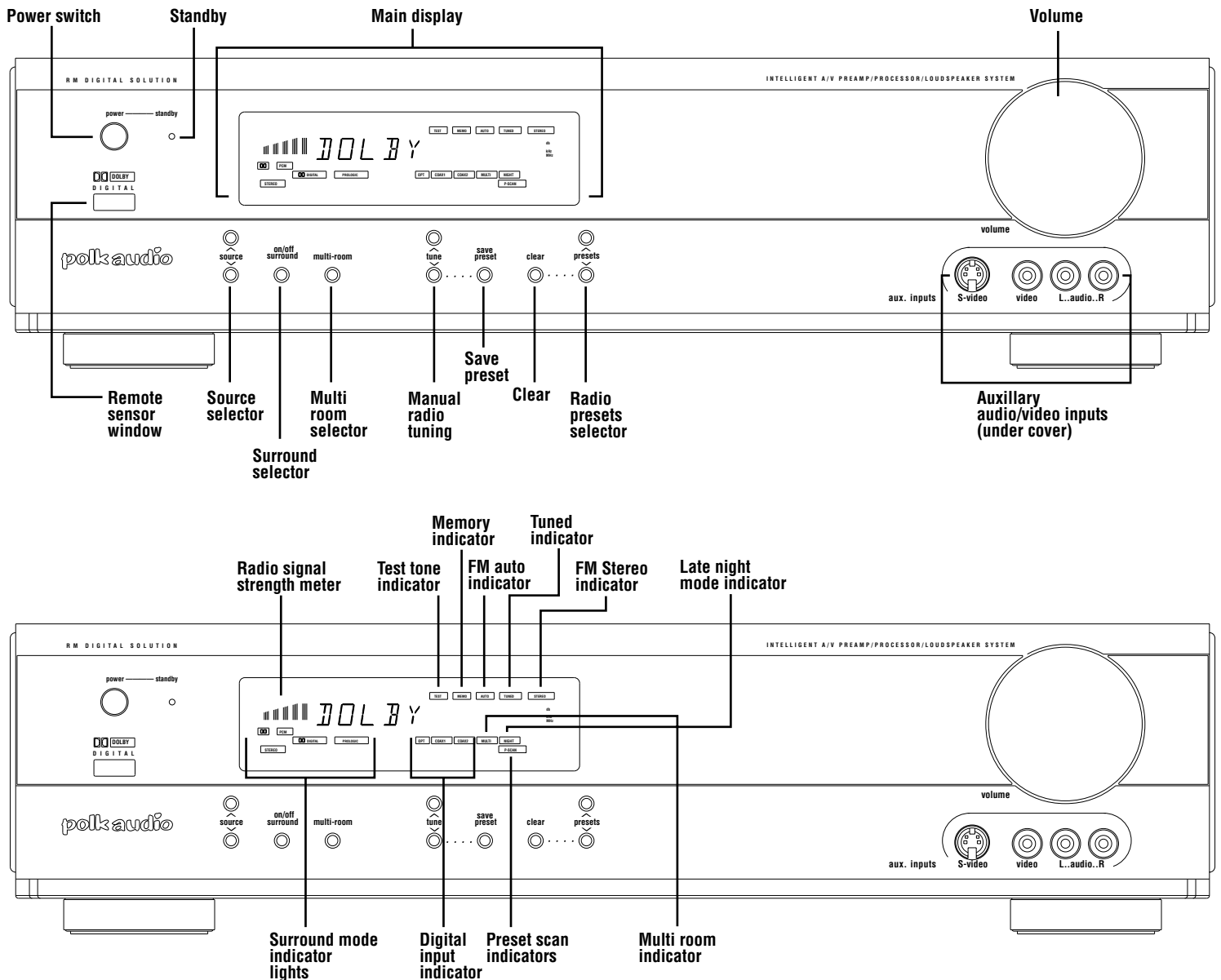

PREAMP/PROCESSOR FRONT PANEL GUIDED TOUR

Power Switch And Standby Indicator

When this switch is pressed once, the power turns ON and lights appear on the Main Display panel. When pressed again, the power turns OFF and the standby indicator light glows red. Make sure the Power switch on the back of the subwoofer enclosure is set to the "On" position. When you turn on the preamp/processor, the amplifiers in the subwoofer enclosure will also turn on and you will see a green glow on the base of the subwoofer. When the preamp/processor is turned "Off" the amplifiers turn off, and the light in the subwoofer base glows red.

Main Display

Displays a variety of information depending on what action was most recently taken. Normally, it indicates the current selected input (CD, DVD, etc.). It also displays the current selected surround mode (Stereo, Pro Logic, or Dolby Digital) as well as volume, bass level, and other information on a "flash" basis. See the next page for an explanation of all those little teeny lights.

Volume Control

Adjusts the overall sound level. Turning the control clockwise increases the sound level, turning it counter-clockwise decreases the volume level.

Remote Sensor Window

This window receives infrared signals from the remote control unit. Aim the remote control unit to this sensor window. Do not allow any solid object to block the path between the remote control and this window.

Source ▲ ▼ Selector Buttons

These buttons are used to select the source of sound and video such as DVD, DSS, VCR, LD, and AUX. Video and audio are switched simultaneously on those inputs that have both video and audio input jacks. For example, when you select DVD, the picture and sound of the DVD player are automatically switched on together. The buttons toggle through the inputs in the following sequence:

[DVD ↔ DSS ↔ DIG ↔ CABLE/LD ↔ LD/RF]

 [VCR ↔ AUX ↔ FM ↔ AM ↔ CD ↔ TAPE]

See page 22 for more information on using this feature.

IMPORTANT NOTE:

The FM radio, AM radio, CD, and Tape audio inputs do not have corresponding video inputs. When you select any of these sources, you will see a blank screen on your TV (if your TV is on).

On/Off Surround Button

This button switches between surround sound and 2 channel stereo.

IMPORTANT NOTE: The Dolby Digital (AC-3) mode can be selected only when either LD, DSS Digital, or DVD inputs are selected. If you have selected a digital source with a Dolby Digital soundtrack and you cannot get the "3/2.1" indicator on the display (see page 24), the most likely causes are:

1. The DVD player is not set to send out a 5.1 channel Dolby Digital signal. In this case check the DVD player's operation manual.
2. The 5.1 soundtrack has not been selected on the DVD disc. In this case press the disc menu button on your DVD player to access the DVD disc's menu, and select Dolby Digital 5.1 on the disc's set-up menu. Consult your DVD player's operation manual for more information.
3. The DVD disc does not have a 5.1 surround soundtrack. This is especially true of pre-1985 movies.

Multi Room Button

Pressing this button switches the multi room mode on and off. See page 25 for more information on using this feature.

Tune ▲ ▼ buttons

When either the AM or FM sources are selected, these buttons allow you to manually tune AM and FM radio stations. Pressing the ▲ button moves the tuner up the radio band. Pressing the ▼ button moves the tuner down the radio band. The tuner stops as soon as you release your finger from the button. See page 22 for more information on using this feature.

Save Presets Button

When you want to select a radio station as a preset station, manually tune to that station, press and hold this Save Presets button for 4 - 5 seconds. You will see the red MEMO light on the display flash. When the MEMO light stops flashing, the radio station has been saved and assigned the next available preset slot number. You may preset up to 30 AM and 30 FM radio stations. See page 23 for more information on using this feature.

Clear Button

When you want to clear a radio station from the list of presets, select that preset station, then press and hold the Clear button until CLEAR appears on the display. See page 22 for more information on using this feature.

Presets ▲▼ Buttons

These buttons select from the list of preset radio stations. Pushing the ▲ button moves from lower preset numbers to the higher preset numbers. Pushing the ▼ button moves down through the list of preset stations.

Aux Inputs Jacks

These auxiliary video/audio input jacks are revealed by removing the oval rubber cover. They accept the connection of a camcorder, portable VCR, or any other temporary source. To make proper connections, refer the owner's manual of the auxiliary component.

WHAT THOSE TEENY LITTLE LIGHTS MEAN

Radio Signal Strength Meter

This meter shows the relative signal strength of a radio signal. For best reception, orient your antenna to get the maximum number of bars on this meter.

Test Tone Indicator

This light illuminates when the surround sound balance test tone is engaged. You should hear a "ssshhhhh" noise from one speaker when this is on. See page 20 for more information.

Memory or Memo Indicator

This light illuminates when saving preset radio stations. See page 23 for more information.

FM Auto Indicator

Shows that the tuner is prepared to receive a stereo FM broadcast.

Tuned Indicator

This lights when a radio station has been properly tuned in.

FM Stereo Indicator

Lights when a stereo FM broadcast is received.

Surround Mode Indicators

Indicates whether the system is delivering Stereo, Dolby Pro Logic, or Dolby Digital sound. See page 24 for more information.

Digital Input Indicators

Indicates which digital audio input is selected and operating.

Late Night Indicator

Indicates that the late night compression circuit is engaged. See page 23 for more information on this function.

Preset Scan Indicator

Lights when the tuner is scanning through the radio station presets.

Multi Room Indicator

Lights when the multi room function is engaged. See page 25 for more information.

REMOTE CONTROL OPERATION

Loading Remote Control Batteries

1. Remove the back cover.
2. Insert two AA type batteries with correct (+) and (-) polarity.
3. Close the back cover until it clicks.

The batteries will last about 4 months with normal use. Change the batteries as soon as you notice that the range of the remote control is decreasing.

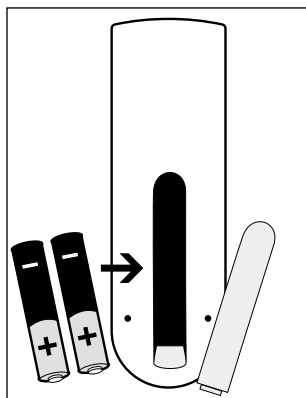

Remote Control Range

The distance between the remote control transmitter and the RMDS-1 preamp/processor should be 15 feet (5 meters) or less. If the transmitter is pointed to a direction other than the IR SENSOR or if there is an obstacle between them, the remote control may not work correctly.

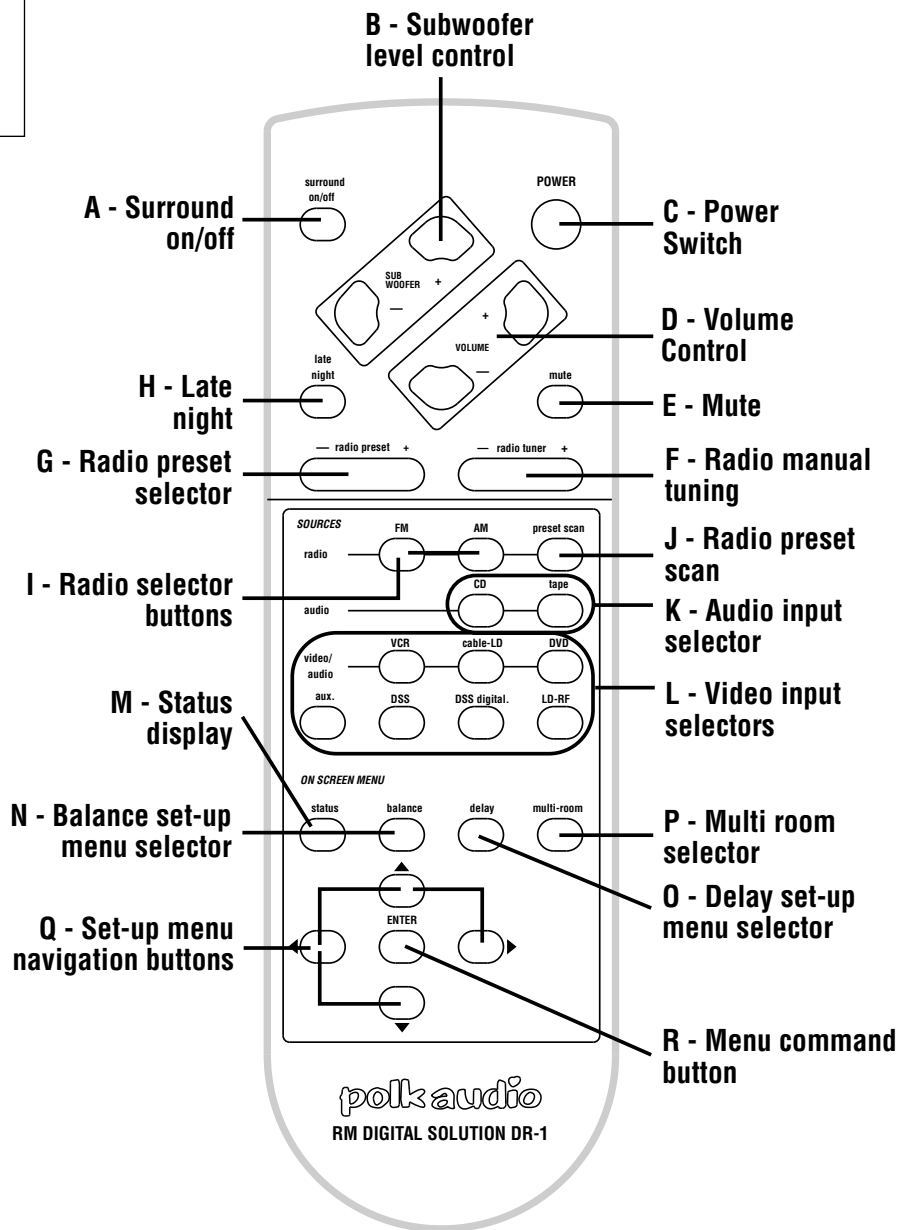
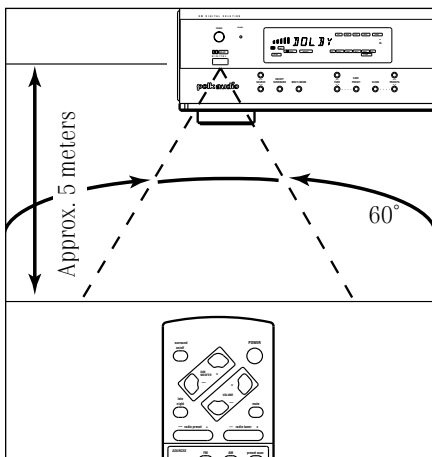

REMOTE CONTROL GUIDED TOUR

The remote control is divided into three major sections. The top section contains the controls used most often, such as ON/OFF, MUTE, SUBWOOFER volume and system VOLUME controls. The middle section has the source buttons, where you select the source component you want to hear and see. The bottom set of buttons are set-up buttons that are rarely used. Most folks will use them once to set up the system and never touch them again. For that matter you could never touch them and you'll still get great sound from your RM Digital Solution system!

A - Surround On/Off Button

This button switches between surround sound and 2 channel stereo.

B - Subwoofer +/- Buttons

Push (+) to increase and (-) to decrease the bass volume. The RMDS-1 "remembers" the bass level for stereo and surround modes. For example, if you are watching a DVD and you select a bass level of -7, then switch to a CD in stereo and change the bass setting to -10, the system will return to a bass setting of -7 when you go back to the surround mode.

C - Power Switch

When this switch is pressed once, the power turns ON and lights appear on the display panel. When pressed again, the power turns OFF and the standby indicator light on the preamp/processor glows red. Make sure the power switch on the back of the subwoofer enclosure is set to the "Standby" position. When you turn on the preamp/processor, the amplifiers in the subwoofer enclosure will also turn on and you will see a green glow on the base of the subwoofer. When the preamp/processor is turned "Off," the amplifiers turn off and the light in the subwoofer base glows red.

D - Volume +/- Buttons

Push (+) to increase and (-) to decrease the overall volume of the system.

E - Mute Button

Push this button to temporarily silence the sound. When mute is on, you will see "MUTE" appear on the preamp/processor display. Pressing the Mute button a second time or pressing either of the Volume buttons will release the mute, sound will resume, and the MUTE light turns off.

F - +/- Radio Tuner Button

When either the AM or FM sources are selected, these buttons allow you to manually tune AM and FM radio stations. Pressing the right (+) side of the rocker button moves the tuner up the radio band. Pressing the left (-) side of the rocker button moves the tuner down the radio band. If you hold your finger on the button for a few seconds, the tuner will "fast forward" through the frequencies. The tuner stops as soon as you push the button a second time.

G - +/- Radio Preset Button

This button select from the list of preset radio stations. Pushing the right (+) side of the rocker button moves from lower preset numbers to the higher preset numbers. Pushing the left (-) side of the rocker button moves down through the list of preset stations. See page 23 for more information on using this feature.

H - Late Night Button

This button toggles between Late Night and Normal modes. In the Late Night mode the dynamic range of the signal is reduced. That means that loud sounds are made less loud. This is a great feature to use anytime you want to watch action/adventure movies and avoid bothering other people in the house. This feature only works with Dolby Digital inputs such as DVD, LD, and Dolby Digital equipped DSS. When you push this button, the word "NIGHT ON" appears in the main display window for a few seconds and the small **NIGHT** mode light in the lower right hand corner of the display illuminates. Push the button again and "NIGHT OFF" appears for a few seconds. (See page 23.)

I - FM and AM Buttons

Push the AM button to listen to AM band radio stations or push the FM button to listen to FM radio band radio stations.

J - Preset Scan Button

Push this button when you want to scan through the radio stations you have preset. The tuner will play each preset station for a few seconds, then move on to the next preset station. The scanning stops as soon as you push the button again. **P-S-CAN** will flash in the display window while this mode is in use.

K - Audio Input Buttons

Push these buttons to listen to either CD or tape players.

L - Video/Audio Input Buttons

Push the appropriate button to select an audio/video source. Both audio and video inputs will be selected at the same time.

M - Status Button

Push this button to display the audio status of the preamp/processor on your TV screen for five (5) seconds. It will display the current source (DVD, FM, etc.), the mode (Dolby Digital, Pro Logic, Stereo), Multi Room status ("off" or the selected multi room source), Subwoofer Level, and Master Volume level.

N - Balance Button

Push this button to display the Channel Balance Menu on your TV screen. See "SET UP AND CALIBRATION" on page 20.

O - Delay Button

Push this button to display the Delay Menu on your TV screen. See "SET UP AND CALIBRATION" on page 20.

P - Multi-Room Button

Push this button to display the Multi-room Menu on you TV screen. See "USING MULTI ROOM" on page 25.

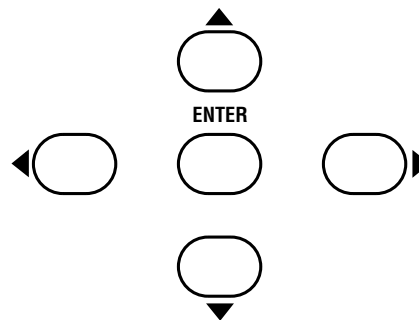

Q - Cursor Buttons

These buttons allow you to change the position of the **▶** cursor and make selections on the on-screen menus. The **▲** and **▼** arrow buttons move the cursor through the menu selections and the **◀** and **▶** arrow buttons make selections such as "On" and "Off" and other menu choices.

R - Enter (Command) Button

Push the ENTER button to exit Channel Balance and Delay menus.

SET-UP AND CALIBRATION

After you have connected all speakers and source components you may start using the RMDS-1 without any further set-up procedures and get excellent performance in most homes. One of the many benefits of the Polk RM Digital Solution system is that the electronics and speakers have been perfectly optimized for the highest Dolby Digital performance without the need for complicated set-up and calibration procedures. There are only two adjustments you may want to perform to optimize the system for your room and speaker placement. Those adjustments are "Channel Balance" and "Delay." The factory presets for these two optional adjustments were selected to provide high quality balanced sound in the vast majority of set-ups. If you are anxious to listen to your new system right now (we understand), skip this section and come back to it later.

Setting Channel Balance

This procedure sets the relative volume of the 5 satellite speakers so that you hear equal sound from every speaker, even if you are sitting closer to one speaker than the others. You may do these adjustments by ear or by using a Sound Pressure Level meter (available at Radio Shack for \$40 -\$60). Consult the meter's operating manual for its proper use.

1. Sit in your normal listening position.
2. Turn on the TV that is connected to the video output of the RMDS-1 preamp/processor. Adjust the main volume control on the remote or front panel to a typical listening level. If you are using an SPL meter, set the volume to 70dB.
3. Select a multi-channel source input such as DVD or LD.
4. Select Dolby Digital or Dolby Pro Logic processing by pressing the "Surround On/Off" button on the remote control or the preamp/processor front panel.
5. Press the "Balance" button on the remote control. You should see this menu on your TV screen:

-CHANNEL BALANCE-	
▶FRONT LEFT	: 0dB
CENTER	: 0dB
FRONT RIGHT	: 0dB
SURROUND R	: 0dB
SURROUND L	: 0dB
TEST TONE	: OFF
DEFAULTS	: ON
EXIT	: SAVE/NO SAVE

6. Use the up/down directional buttons on your remote control ▲▼ to move the arrow-shaped cursor ▶ to "TEST TONE."
7. Use the right directional button on the remote control ▶ to select Test Tone "ON."

-CHANNEL BALANCE-	
FRONT LEFT	: 0db
CENTER	: 0db
FRONT RIGHT	: 0db
SURROUND R	: 0db
SURROUND L	: 0db
▶TEST TONE	: ON
DEFAULTS	: OFF
EXIT	: SAVE/NO SAVE

8. A "shhhhhhhh" noise should now be coming from the Front Left speaker.
9. Use the left/right directional arrows on the remote control ◀▶ to raise or lower the tone to a comfortable volume level. The SPL meter should read "0."

IMPORTANT NOTE:

If at any time during this procedure the test tone comes from the wrong speaker, you have made a speaker connection mistake. Push the "Balance" button on the remote to cancel this procedure. Re-read the "Subwoofer and Speaker Connections" section of this manual and correct the wiring error before returning to this procedure.

10. You will see a small square indicator cursor next to the current speaker. Use the ▲▼ directional buttons on the remote to "pick up" the indicator and move it to the next speaker in the array, "Center."
11. The test tone should now come from the center speaker.
12. Use the left/right directional arrows on the remote control ◀▶ to raise or lower the tone volume of the Center speaker to match the volume of the Left Front speaker.

-CHANNEL BALANCE-	
FRONT LEFT	: 0dB
▶CENTER	: +1dB
FRONT RIGHT	: 0dB
SURROUND R	: 0dB
SURROUND L	: 0dB
TEST TONE	: ON
DEFAULTS	: OFF
EXIT	: SAVE/NO SAVE

13. Repeat this procedure for all channels until all 5 speakers sound like they are playing at the same volume level. In most cases the range of needed adjustment should not be more than a few dB up or down.
14. Use the up/down directional buttons on the remote ▲▼ to move the arrow shaped cursor to "EXIT."
15. The "Save" should be highlighted. If it isn't, use the left directional arrow to highlight "Save."
16. Press the Enter button on the remote control to save and exit this menu. The preamp/processor will now go back to normal operation.
17. If you feel like you have made errors and wish to cancel the adjustments you have just made, highlight "NO SAVE" and exit. The balance settings will return to where they were.
18. To return to the factory preset balance settings, move the cursor to "DEFAULTS," select "ON" and exit.

Once you have completed this procedure you can leave it alone. You may occasionally encounter a movie or recording that was produced in such a way that it doesn't sound channel-balanced even though you are certain that your system is properly balanced. Don't sit there and suffer. Push the balance button to go to the Channel Balance menu and make whatever adjustment you feel will make that recording sound good to you. Remember to "Save" the new settings before exiting.

SETTING CHANNEL DELAY

The time delay circuit ensures that the sounds from all the speakers arrive at your ears properly synchronized. This ensures that the surround sound effects are as natural and enveloping as the recording allows. The RMDS-1 is preset to default values that will yield excellent sound quality in all but the most unusual room and speaker set-up situations. If you want to be sure that your system is optimized for your set up, use the following procedures.

Setting Dolby Digital Delay

The RMDS-1 is factory preset to default values of Center = 3mS and Surround = 15mS in the Dolby Digital mode. These settings will give excellent performance in the vast majority of homes and set ups. To fine tune these settings, go on to the next page.

1. Play a Dolby Digital source and push the DELAY button on the remote control. This menu will appear on your TV screen:

```

-CHANNEL DELAY-
▶CENTER   : 3mS
SURROUND  : 15mS
DEFAULTS  : ON
EXIT      : SAVE/NO SAVE
  
```

2. Measure the distance from your main listening position to the center speaker in feet (Fig. 1).

3. Measure the distance from your main listening position to the front speakers in feet (Fig. 1).

4. Subtract the center distance (B) from the front speaker distance (A). In the example in Figure 1, that would be $20 - 18 = 2$.

5. Use the ▲ up and ▼ down arrow keys on the remote to move the arrow shaped cursor on the menu to CENTER.

6. Use the ◀ left and ▶ right arrow keys to select the correct center delay time. For every 1 foot of difference, select 1 mS of center delay. The range of choices are 0,1,2,3,4, and 5 mS. In this example you would select 2mS. ($20 - 18 = 2$).

```

-CHANNEL DELAY-
▶CENTER   : 2mS
SURROUND  : 15mS
DEFAULTS  : ON
EXIT      : SAVE/NO SAVE
  
```

7. Use the down arrow key on the remote to move the arrow shaped cursor on the menu screen to SURROUND.

8. Measure the distance from your main listening position to the surround speakers in feet (Fig. 1). Subtract the surround distance (C) from the front distance (A). In the example in Fig. 1, that would be $20 - 10 = 10$.

9. Use the chart to determine the correct surround delay. For every 1 foot of difference, select 1 mS of center delay. In this example, the correct surround delay is 10mS.

Front Minus Surround Distance (feet)	Dolby Digital Surround Delay Setting	Pro Logic Surround Delay Setting
1 - 3 feet	5ms	15mS
4 - 6 feet	5ms	20mS
7 - 11 feet	10ms	25Ms
12 feet or more	15ms	30mS

10. Use the ◀ left and ▶ right arrow keys to select the correct surround delay time shown on the chart. In this example, select 10ms. The range of choices are 5, 10, and 15mS.

```

-CHANNEL DELAY-
CENTER    : 2mS
▶SURROUND : 10mS
DEFAULTS  : OFF
EXIT      : SAVE/NO SAVE
  
```

11. Use the ▼ arrow key on the remote to move the arrow shaped cursor down to EXIT. Make sure SAVE is highlighted.

12. Push the ENTER button on the remote.

```

-CHANNEL DELAY-
CENTER    : 1ms
SURROUND  : 10ms
DEFAULTS  : OFF
▶EXIT     : SAVE / NO SAVE
  
```

13. If at any time you wish to return to the preset factory defaults, return to this on-screen menu, select DEFAULTS ON, save and exit. The factory settings will be restored.

Setting Dolby Pro Logic Delay

The channel delay function for Dolby Pro Logic exists for a somewhat different reason than for Dolby Digital. There is a different default surround delay value than that for Dolby Digital. Dolby Pro Logic does not require a center channel delay. The factory preset delay default values are Center = None and Surround = 30mS.

(Fig. 1)

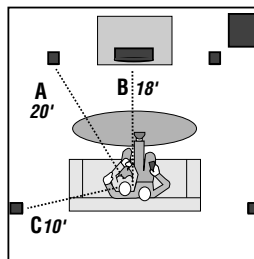

Dolby Digital
Center delay = 2ms
Surround delay = 10ms

Pro Logic
Surround delay = 25ms

1. Play a Dolby Pro Logic source and select Surround "On." Push the Delay button on the remote control and this menu will appear on your TV screen:

```

-CHANNEL DELAY-
CENTER    : NONE
▶SURROUND : 30mS
DEFAULTS  : ON
EXIT      : SAVE/NO SAVE
  
```

2. Measure the distance from your main listening position to the front speakers in feet (Fig. 1).

3. Measure the distance from your main listening position to the surround speakers in feet (Fig. 1).

4. Subtract the surround distance (C) from the front distance (A). In this example, it is 15.

5. Use the chart to find the proper surround delay time.

6. Use the down arrow key on the remote to move the arrow shaped cursor on the menu screen to SURROUND.

7. Use the ◀ left and ▶ right arrow keys to select the correct surround delay time shown on the chart. In this example, select 25ms. The range of choices are 15, 20, 25, and 30mS.

```

-CHANNEL DELAY-
CENTER    : NONE
▶SURROUND : 25mS
DEFAULTS  : OFF
EXIT      : SAVE/NO SAVE
  
```

8. Use the ▼ arrow key on the remote to move the arrow shaped cursor down to EXIT. Make sure SAVE is highlighted.

9. Push the ENTER button on the remote.

```

-CHANNEL DELAY-
CENTER    : NONE
SURROUND  : 25ms
DEFAULTS  : OFF
▶EXIT     : SAVE/NO SAVE
  
```

10. If at any time you wish to return to the preset factory defaults, return to this on-screen menu, select DEFAULTS ON, save and exit. The factory settings will be restored.

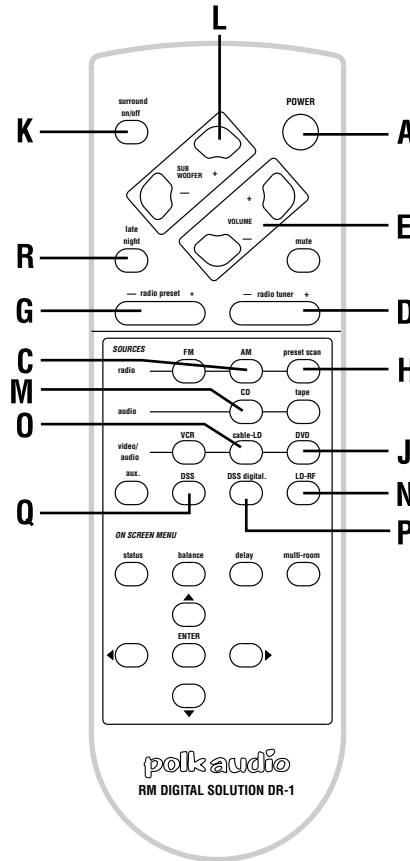
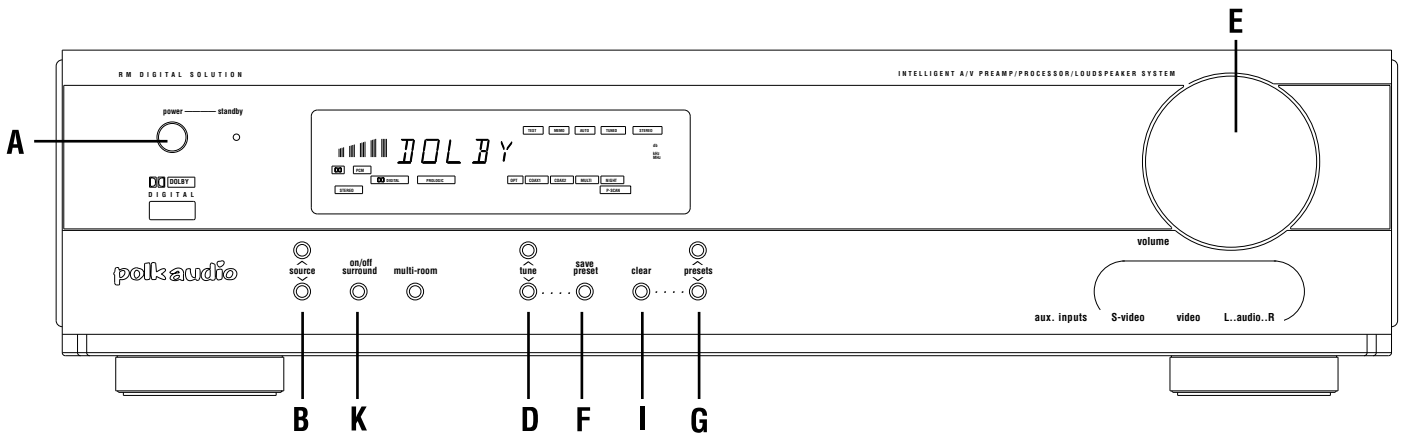

HOW TO USE YOUR RM DIGITAL SOLUTION SYSTEM

Listening to the radio

1. Press the **POWER** switch (A) to turn on the power.
2. Press one of the **SOURCE** buttons (B) on the front panel, or the AM or FM buttons on the remote (C) to select either the FM or AM band.
3. Press the **TUNE UP** and **DOWN** buttons (D) to tune in the desired station. Pressing once for less than a half second changes the frequency by one step. Pressing longer sequentially scans frequencies in the indicated direction. Releasing the button in this state activates the auto tuning function which automatically scans the frequencies until it reaches a station, at which point the TUNED and signal level indicators light and auto tuning stops.
4. Adjust the volume with the **VOLUME** control (E).

IMPORTANT NOTES ON FM RADIO RECEPTION:

The supplied FM antenna will only allow the tuner to pick up strong local radio stations. If you want better reception of distant FM stations you will need a better FM antenna. Your Polk Audio dealer can recommend a high quality indoor or outdoor FM antenna. Be sure to get one with a 75 Ohm coaxial output. If you already have a TV roof antenna, you can use it for the FM tuner. Get a signal splitter from a radio/TV dealer or Radio Shack store. It will allow you to use the same antenna for TV and FM radio reception.

If a radio station you select has a lot of background noise or otherwise sounds distorted, the tuner is not getting a strong enough signal. Look at the Signal Strength indicator in the upper left hand corner of the display. If there are three or fewer bars lit, that means you need to point the antenna in a different direction. Watch the signal strength meter as you slowly rotate the antenna, noting which direction gives you the strongest reading on the meter. If you still don't get clear reception of the radio station, you either need a better antenna, or the broadcast station is too far away from your home for good reception.

Presetting Radio Station

You can preset up to 30 FM/AM stations in any order. Stations can be preset either manually (by you) or automatically (by the tuner).

Auto Presetting

This function scans the frequencies in the selected band and automatically presets all stations that can be received.

1. Select the **AM** band (**B**).
2. Manually tune in the lowest receivable frequency (520 kHz) using the **TUNE** buttons on the front panel (**D**) or **RADIO TUNER** on the remote (**D**).
3. Select the **FM** band (**B**).
4. Manually tune in the lowest receivable frequency (87.50 MHz) using the **TUNE** buttons on the front panel (**D**) or **RADIO TUNER** on the remote (**D**).
5. Operation stops automatically when all 50 preset memory positions are filled or when auto scanning attains the highest end of all bands.
6. To stop the auto preset function in mid-operation, press any one of the input buttons.

Manual Presetting

Manually tune-in a desired station. Press the **SAVE PRESETS (F)** button on the front panel of the preamp/processor until **MEMO** starts blinking on the display. The radio station will automatically be saved to the next available preset slot.

Recalling a Preset Station

Each press of the **RADIO PRESETS** buttons (**G**) on either the remote or **RMDS-1** front panel moves the tuner to the next or previous preset station. You can "fast forward" or "fast reverse" through the preset stations by holding down the **▲** or **▼** **PRESETS** buttons. The operation continues until the button is released.

Preset Scan Tuning

1. Press the **PRESET SCAN (H)** button on the remote control. **P-SCAN** blinks on the display. (The preset station with the smallest preset number is recalled first. If no stations have been preset, **CH00** blinks in the display and the unit returns to the previous mode).
2. Preset stations are recalled in sequence (**CH-1**, **CH-2**, etc.) for 5 seconds each. Preset numbers that do not contain stations are skipped.
3. When the desired preset station is received, cancel the preset scan operation by pressing the **PRESET SCAN (H)** button again. The **P-SCAN** indicator will turn off.

Clearing Preset Stations

You can remove preset stations from memory using the following procedure.

1. Recall the preset number to be cleared with the method described in "Recalling a Preset Station."
2. Press the **CLEAR** button (**I**) for more than 3 seconds. "CLEAR" appears on the display to indicate that the specified preset number has been cleared.
3. If desired, you can clear all of the memory contents with a single operation, as follows: Press the **SAVE PRESETS** button (**F**), **CLEAR** button (**I**) and **PRESETS ▲** button (**G**) simultaneously for more than 3 seconds. **CAUTION:** The "all memory clear" operation clears all memory including the volume level and surround mode memory and turns the power OFF.

Playing a DVD (or other audio/video source)

1. Turn unit on by pressing **POWER** button (**A**).
2. Push the DVD input button (**J**) on the remote or use the **SOURCE ▲ ▼** buttons on the front panel (**B**) to toggle through the sources until the display reads "DVD."
3. Select Dolby Digital surround mode by pushing the **SURROUND ON/OFF** button (**K**) on either the remote or preamp/processor front panel, or choose from the DVD's own menu.
4. Select the desired volume level with the **VOLUME** control (**E**).
5. Adjust the bass to your liking with the **SUBWOOFER** control (**L**) on the remote.
6. Enjoy!

Playing a CD (or other stereo audio source)

1. Turn unit on by pressing **POWER** button (**A**).
2. Push the CD input button (**M**) on the remote or use the **SOURCE ▲ ▼** arrows (**B**) to toggle through the sources until the display reads "CD."
3. Select stereo or Dolby Pro Logic surround by pushing the **SURROUND ON/OFF** button (**K**) on either the remote or preamp front panel.

IMPORTANT NOTE:

Most stereo recordings will provide very good surround sound effects when played with the Pro Logic mode engaged, even though they are not encoded in Dolby Surround.

4. Select the desired volume level with the **VOLUME** control (**E**).
5. Adjust the bass to your liking with the **SUBWOOFER** control (**L**).
6. Enjoy!

Playing a Laserdisc

The procedure for playing a laserdisc is just like any other audio/video source except that when you are playing a laserdisc with a Dolby Digital (AC-3) soundtrack, you must press the **LD-RF** button on the remote (**N**). When playing a Laserdisc that only has an analog soundtrack, press the **CABLE-LD** button on the remote (**O**).

Playing a DSS Broadcast

The procedure for playing a DSS receiver is just like any other audio/video source except that if your DSS receiver has a digital audio output, you must press the **DSS DIGITAL** button on the remote (**P**). If your DSS receiver only has analog audio outputs, press the **DSS** button on the remote (**Q**).

Late Night Listening







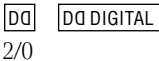
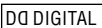
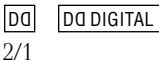

Digital sources like DVD and Laserdiscs offer the advantage of greater dynamic range than analog sources. That means that the contrast is greater between the softest sounds and the loudest sounds on the recording. Wide dynamic range is a great benefit—except when you are watching a movie and other people in the house are trying to sleep. In such circumstances, just push the **LATE NIGHT** button (**R**) on the **RMDS** remote and the dynamic range will be reduced so that you can turn up the volume loud enough to hear the dialog without having the peak sounds get too loud. Once again, domestic harmony is restored thanks to Polk.

ABOUT SURROUND SOUND

The RMDS-1 system offers four modes of operation: Stereo, Dolby Pro Logic, 2 channel Dolby Digital and Dolby Digital 5.1 surround. You might wonder, "what is 2 channel Dolby Digital? Isn't Dolby Digital always 5.1 surround?" The answer is no. Dolby Digital is a digital audio compression system that provides very high fidelity sound quality in either 2 or 6 channels. (The six channels are Left and Right front, Center, Left and Right rear and a Low Frequency Effects channel, or 5.1). The vast majority of Dolby Digital program materials are 5.1 multi-channel recordings. Most DVDs have both 2 channel and 5.1 channel Dolby Digital soundtracks. In most cases the default soundtrack is the 2 channel Dolby Digital soundtrack and you must manually select the 5.1 channel soundtrack via the DVD's menu (see your DVD player's manual for instructions). But some DVDs only have a 2 channel Dolby Digital soundtrack permitting only Dolby Pro Logic surround sound.

You can use the Pro Logic mode with stereo sources such as radio, CD, and tape to get very good surround sound, even though those sources are not Dolby Surround encoded. Dolby Surround encoding is compatible with stereo and mono playback, so conventional stereo programs sound similar to surround encoded program when played with the Pro Logic surround mode engaged. You may want to leave the RMDS-1 in the surround mode all the time.

The chart below shows which modes are possible with which inputs, and how to tell which mode you are in by looking at the front panel display.

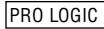
When you see this on the display:	That means you are listening to:	And your program material is:	That can be delivered by these sources:
 	Stereo	2 channel Dolby Digital	DVD, DSS satellite TV (only with special Dolby Digital equipped satellite receivers), Digital TV broadcasts (future)
  	Pro Logic Surround	2 channel Dolby Digital	DVD, DSS satellite TV (only with special Dolby Digital equipped satellite receivers), Digital TV broadcasts (future)
 	Dolby Digital 5.1 Surround	5.1 channel Dolby Digital	Most DVDs, some 12" laserdiscs, Digital TV broadcasts (future)
	Stereo	2 channel Dolby Surround (Pro Logic) encoded	Most Hi-Fi video tapes, some TV broadcasts
	Pro Logic Surround	2 channel Dolby Surround (Pro Logic) encoded	Most Hi-Fi video tapes, some TV broadcasts
	Stereo	2 channel stereo	FM radio stations, CDs, LP records, most TV broadcasts
	Pro Logic Surround	2 channel stereo	FM radio stations, CDs, LP records, most TV broadcasts

The RMDS-1 is manufactured under license from Dolby Laboratories Licensing Corporation. "Dolby," "AC-3," and the double-D symbol are trademarks of Dolby Laboratories Licensing Corporation.

USING MULTI ROOM FEATURE

The Multi Room feature allows you to listen to an audio source connected to the RMDS-1 system in another room of the house. For example, you can watch a movie in the living room while your children listen to the CD player in the family room. In order to use this feature, you will need a pair of powered speakers (such as Polk AMR-5), or another pair of speakers and integrated amplifier, and two RCA type interconnect cables long enough to reach from room to room. Connect the system as shown in Fig. 1. Follow the steps below to use the multi room feature.

Operating from the remote control:

1. Turn on the TV that is connected to the video output of the RMDS-1 preamp/processor.
2. Push the MULTI ROOM button on the remote control. The menu shown below will appear on your TV screen.

-MULTI ROOM SOURCE-	
▶MULTI ROOM	: OFF
SOURCE	: CD
VOLUME	: 80dB
EXIT	: SAVE/NO SAVE

3. Push the right arrow on the remote control to select MULTI ROOM "ON."

-MULTI ROOM SOURCE-	
▶MULTI ROOM	: ON
SOURCE	: CD
VOLUME	: 80dB
EXIT	: SAVE/NO SAVE

4. Use the down arrow to go to SOURCE, then toggle through the source choices by pushing the left or right ◀▶ arrows.

-MULTI ROOM SOURCE-	
MULTI ROOM	: ON
▶SOURCE	: FM
VOLUME	: 80dB
EXIT	: SAVE/NO SAVE

5. Move the cursor down to VOLUME and use the up and down arrows ▲▼ to select a volume level.

IMPORTANT NOTE:

For the sake of convenience the remote room amplifier should have a volume control of its own. The goal of setting the volume on the Multi Room menu is to supply the remote amp with enough gain (volume) to make the signal audible, but not so much to overload the input. Set the volume control of the remote integrated amplifier to about the 10:00 o'clock position. Raise the RMDS-1 Multi Room volume until the sound in the remote room is moderately loud. That should give you a comfortable range of volume control on the remote amp.

-MULTI ROOM SOURCE-	
MULTI ROOM	: ON
SOURCE	: CD
▶VOLUME	: 20dB
EXIT	: SAVE/NO SAVE

6. Move the cursor down to the EXIT line. Press the Enter button on the remote control to save and exit this menu. The preamp/processor will now go back to normal operation.

Operating from the front panel

1. Push the MULTI ROOM button on the front panel of the preamp/processor.
2. The red MULTI indicator will blink and the words "SEL SOURCE" will appear on the display.
3. Push the either the ▲ or ▼ SOURCE button to select the source you would like to play in the remote room.
4. A few seconds after you select the source, the words "MULTI VOL" will appear in the display window. The red MULTI indicator continues to blink.
5. Turn the volume control to -15dB.

IMPORTANT NOTE:

For the sake of convenience the remote room amplifier should have a volume control of its own. The goal of setting the volume on the Multi Room menu is to supply the remote amp with enough gain (volume) to make the signal audible, but not so much to overload the input. Set the volume control of the remote integrated amplifier to about the 10:00 o'clock position. Raise the RMDS-1 Multi Room volume until the sound in the remote room is moderately loud (in the range of -20dB to -5dB). That should give you a comfortable range of volume control on the remote amp.

6. Wait about another 10 seconds, the MULTI light will stop flashing and the RMDS-1 will return to normal operation.
7. When you push the MULTI ROOM button again, the Multi Room function turns off and stops sending sound to the remote room.

8. Any time you want sound in the remote room, just push the MULTI ROOM button and the unit will recall the source and volume level that you selected the last time you used the multi room function.

9. If you want to change the multi room source or volume level, just repeat steps 2 through 6, or use the remote control, as described above.

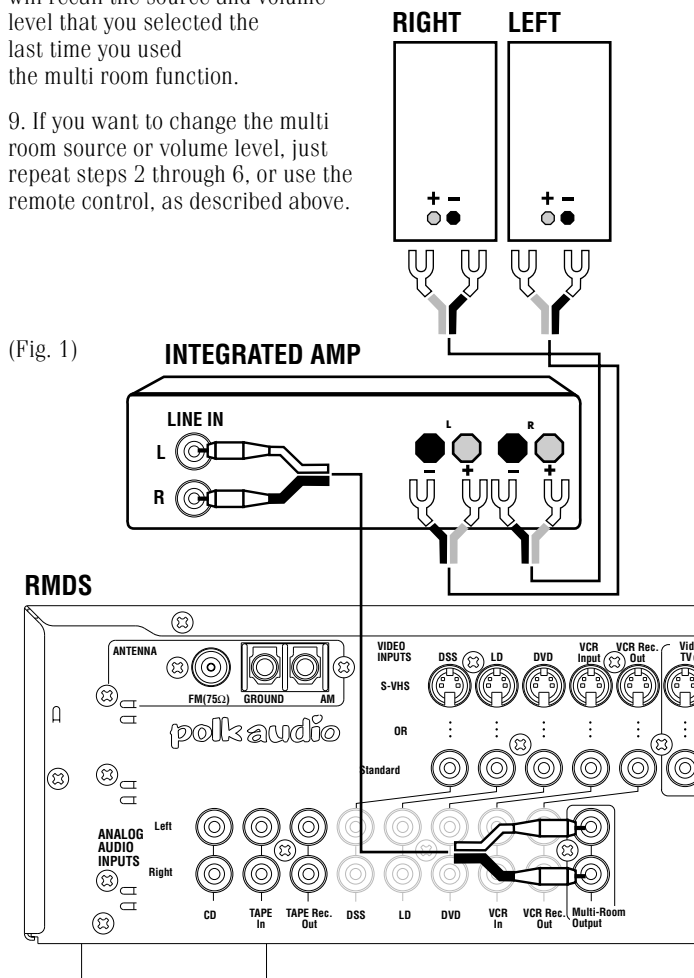

(Fig. 1)

TROUBLESHOOTING

If something doesn't seem to work right, please use the chart below before calling your dealer or Polk Audio. You will actually save time in the long run if you have already eliminated some of the possible reasons for the problem.

If this happens:

No sound from any speaker with any source.

No sound from one satellite speaker.

No sound from the rear surround speakers.

The system will not go into Dolby Digital 5.1 surround sound with a DVD. Pro Logic 2/1 appears in the display window.

Some Laserdiscs make sound and some don't.

Try this:

Make sure the subwoofer is plugged in to a live AC outlet, and that the power switch on the back of the sub is set to "Standby."

Make sure the 4 meter cable that connects preamp/processor and subwoofer is firmly inserted and screwed in.

Make sure the MUTE light is not lit on the front panel display.

Check the small pilot light on the bottom of the subwoofer enclosure, just above the base. It should be glowing either red or green.

Double check all speaker wire connections at the amplifier and the speakers to make sure they are secure.

Disconnect the silent satellite speaker from its speaker wires and replace it with a working satellite speaker.

Press the Surround On/Off button on either the remote control or front panel. Either DOLBY DIGITAL 3/2.1 or PRO LOGIC 2/1 will appear in the display window.

If you are listening to a TV or FM broadcast, it is possible that the broadcast is not in stereo. The surround processor must have at least a stereo signal from which to derive surround sound.

Make sure the DVD player is set up to deliver a 5.1 signal to the RMDS-1 system. Check your DVD owner's manual to learn how to access the DVD player's menu. Select 5.1 operation.

The default sound on DVDs is 2 channel stereo. Make sure the DVD itself is set to 5.1. Push the Menu or Title button on the DVD player's remote control to access the menu of the DVD disc. Look in "Languages" or "Sound Set Up" to find and select Dolby Digital 5.1 sound.

Make sure you have made a secure digital connection between the digital output of the DVD player and the Digital DVD input on the RMDS-1 preamp.

Make sure you connect the RF AC-3 output *and* the analog outputs to the LD input of the RMDS-1. Non-Dolby Digital LDs can only get the soundtrack to the RMDS-1 through the analog outputs. Push the cable-LD button on the remote to hear analog Laserdiscs.

Well then:

Still doesn't work? Try...

If the cable is loose, tighten it, turn the system off and then back on again. Still doesn't work? Try...

Push the MUTE button on the front panel or remote once to turn off the MUTE light and resume sound.

If it isn't glowing at all, disconnect the subwoofer AC cord from the wall socket and remove the fuse that is near the subwoofer's Power switch. If it is blown or if you are in doubt, replace it with an identical fuse.

 **DO NOT USE ANY VALUE FUSE OTHER THAN THAT INDICATED.**

Still doesn't work? Try...

If the "new" speaker doesn't play, the fault is in the speaker wire, power amplifier, or preamp/processor and NOT the satellite speaker. Call your dealer or Polk Audio. If the "new" speaker does play, the fault lies with the speaker.

Still no surround channels? Try...

Try a source that you know for a fact is stereo or multi-channel. If that doesn't work, call your dealer or Polk Audio.

Still no 5.1? Try...

Can't find a 5.1 selection on the title menu? Some DVDs (particularly old movies) only have 2 channel soundtracks. Look carefully at the DVD box to see if it specifically says "5.1 Dolby Digital Soundtrack." If not, just enjoy the Pro Logic surround, because that's all there is on that disc. If you are *sure* it is a 5.1 disc and it still isn't delivering 5.1...

Still no 5.1? Call your Polk dealer or Polk Audio.

This will definitely fix the problem.

Interference

If this unit is placed very near a television, picture disturbance or noise may occur on the TV. In such a case, move the RMDS-1 preamp/processor as far as possible from the television. If the problem persists, re-route the TV antenna cable so that it is as far as possible from the power cable and audio and video connection cables of the RMDS-1 system. Since the phenomenon is most likely to occur when using a TV antenna with a 300-ohm feeder wire, we recommend using an outdoor antenna connected via a 75-ohm coaxial cable.

Safe Limits of Operation

The RM Digital Solution system was made with the highest quality materials for years of trouble-free performance. However, damage to the system can occur if the system is played at excessive listening levels. When the sound becomes harsh or distorted, you have reached the safe limit of operation. Turn down the volume until the sound is clear and undistorted.

Protection Circuits

The RMDS-1 amplifier features several circuits to protect the amplifier and speakers from damage from overheating, shorts, and other electrical faults. If these protection circuits are tripped, all channels will turn off, even if the fault occurs on only one channel. In such cases, turn off the RMDS-1 preamp/processor, remove the fault (usually a short on one of the speaker wires where the + and - wires have touched each other) and turn the system back on again. In the case of overheating, allow the system to cool down for about 15 minutes and re-start the system. Overheating is usually a sign that the amplifier (in the subwoofer enclosure) does not have enough air circulation. Move the subwoofer to a less enclosed space.

Maintaining the Appearance of Your System

The preamp/processor and speaker enclosures may be cleaned with a soft damp cloth or duster. Do not use harsh detergents and cleaning fluids, they can permanently damage the finish. Vacuum the speaker grilles to remove dust.

Q. "Why does my system hum?" A. "It doesn't know the words."

This is what passes for humor in the audio business. Here is the real answer.

In some installations you may hear a humming noise from the subwoofer. Most hum problems are caused by ground loops. That is, the electrical grounds of the components in your system are not at the same electrical potential. To help avoid hum problems, make sure that every component in the audio/video system is plugged in to the same electrical circuit (not necessarily the same outlet). A common ground loop source is cable TV. Disconnect the coaxial cable from your TV and/or VCR. If the hum goes away, the cable TV is the ground loop villain. In that case, you need a 75-ohm ground loop isolator. This device is about the size of a pen and is attached to your coaxial cable where it plugs into your VCR (or television). You can obtain this device from some audio dealers, Radio Shack stores, Xantech (1-800-843-5465) or Channel Plus (1-800-999-5225).

Ground loops and hum can also be the result of faulty electrical wiring in your home. Consult a licensed electrician to evaluate and, if necessary, repair the AC wiring in your home. Light dimmers also tend to introduce noise into audio systems. Remove them.

If none of our suggestions works for you, call our customer service number shown below.

Technical Assistance or Service

If, after following the hook-up and use directions and consulting the troubleshooting chart on page 26, you still have trouble, please call our cheerful customer service representatives. They are happy to answer your questions and provide fast, friendly service. In North America call (800) 377-7655, Monday through Friday, 9:00 AM through 6:00 PM Eastern time. Or you can e-mail us at our Internet service address: polkcs@polkaudio.com.

POLK AUDIO LIMITED WARRANTY

Polk Audio, Inc., warrants to the original purchaser only that the **Preamp/Processor and Amplifier** in this Polk Audio Loudspeaker Product (the "Product") will be free from defects in material and workmanship for a period of three (3) years from the date of original retail purchase from a Polk Audio Authorized Dealer. Polk Audio, Inc., further warrants to the original purchaser only that the **Loudspeaker(s)** in this Polk Audio Product (the "Product") will be free from defects in material and workmanship for a period of five (5) years from the date of original retail purchase from a Polk Audio Authorized Dealer. However, this Warranty will automatically terminate prior to the expiration if you sell or otherwise transfer the Product to any other party. The original retail purchaser shall hereinafter be referred to as "you." To allow Polk Audio to offer the best possible warranty service, please fill out the Product Registration Card(s) and send it to the Factory, at the address provided on the Product Cards(s) within ten (10) days of the date of purchase.

Defective Products must be shipped, together with proof of purchase, prepaid insured to the Polk Audio Authorized Dealer from whom you purchased the Product, or to the Factory at 2550 Britannia Boulevard, Suite D, San Diego, California 92173. Products must be shipped in the original shipping container or its equivalent; in any case the risk of loss or damage in transit is to be borne by you. If upon examination at the Factory or Polk Audio Authorized Dealer it is determined that the unit was defective in materials or workmanship at any time during this Warranty period, Polk Audio or the Polk Audio Authorized Dealer will, at its option, repair or replace with new or reconditioned parts this Product at no additional charge, except as set forth below. All replaced parts and Products become the property of Polk Audio. Products replaced or repaired under this warranty will be returned to you, within a reasonable time, freight prepaid.

This warranty does not include service or parts to repair damage caused by accident, disaster, misuse, abuse, negligence, inadequate packing or shipping procedures, commercial use, voltage inputs in excess of the rated maximum of the unit, cosmetic appearance of cabinetry not directly attributable to defect in materials or workmanship, or service, repair, or modification of the Product which has not been authorized or approved by Polk Audio. This warranty shall terminate if the Serial number on the Product has been removed, tampered with or defaced.

This warranty is in lieu of all other expressed Warranties. If this Product is defective in materials or workmanship as warranted above, your sole remedy shall be repair or replacement as provided above. In no event will Polk Audio, Inc. be liable to you for any incidental or consequential damages arising out of the use or inability to use the Product, even if Polk Audio, Inc. or a Polk Audio Authorized Dealer has been advised of the possibility of such damages, or for any claim by any other party. Some states do not allow the exclusion or limitation of consequential damages, so the above limitation and exclusion may not apply to you.

All implied warranties on this Product are limited to the duration of this expressed Warranty. Some states do not allow limitation on how long an implied Warranty lasts, so the above limitations may not apply to you. This Warranty gives you specific legal rights, and you also may have other rights which vary from state to state.

This Warranty applies only to Products purchased in the United States of America, its possessions, and U.S. and NATO armed forces exchanges and audio clubs. The Warranty terms and conditions applicable to Products purchased in other countries are available from the Polk Audio Authorized Distributors in such countries.

"Polk Audio," "The Speaker Specialists," and "Power Port" are trademarks of Britannia Investment Corporation used under license by Polk Audio Incorporated.

OVERALL HOOK UP

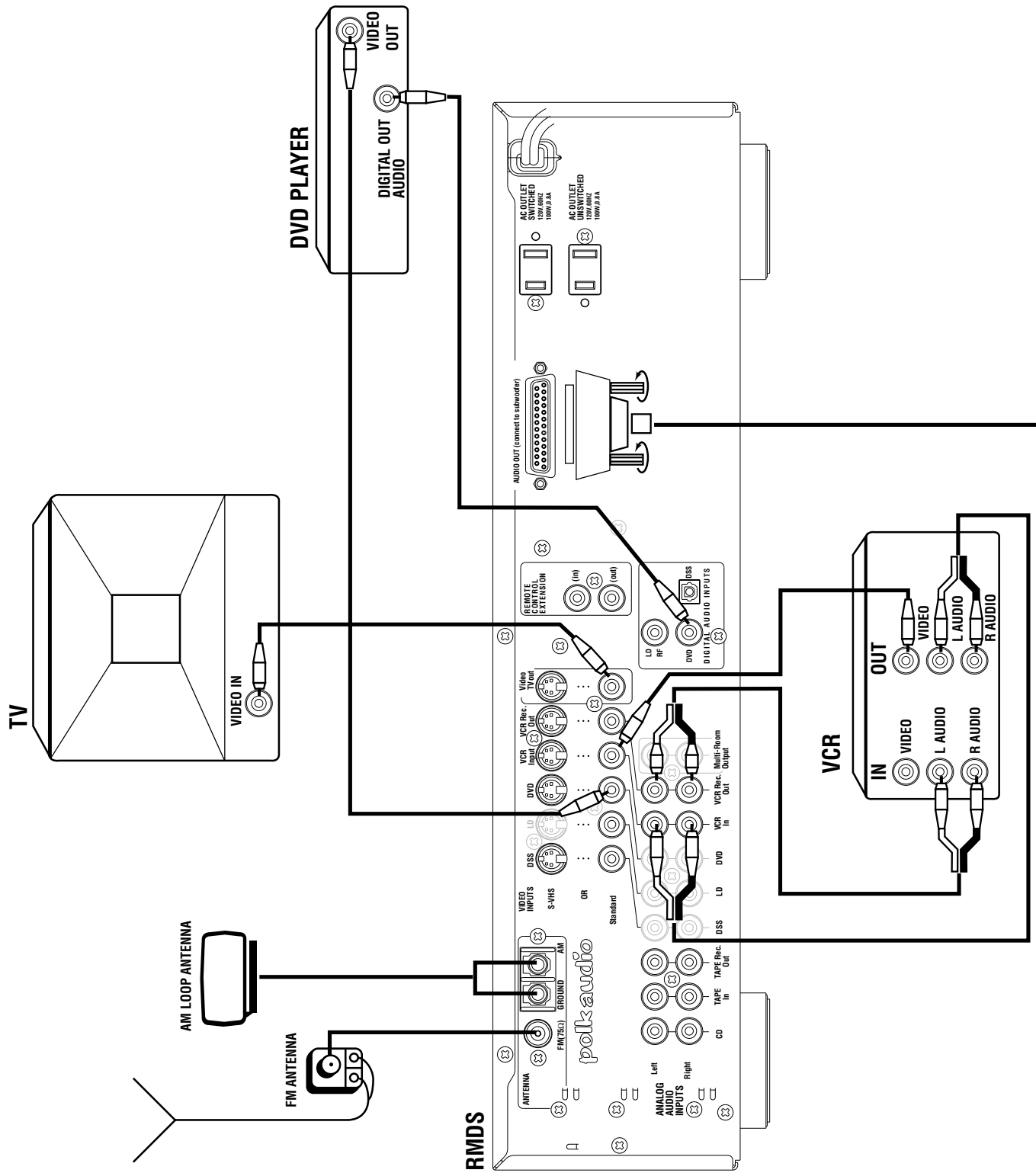

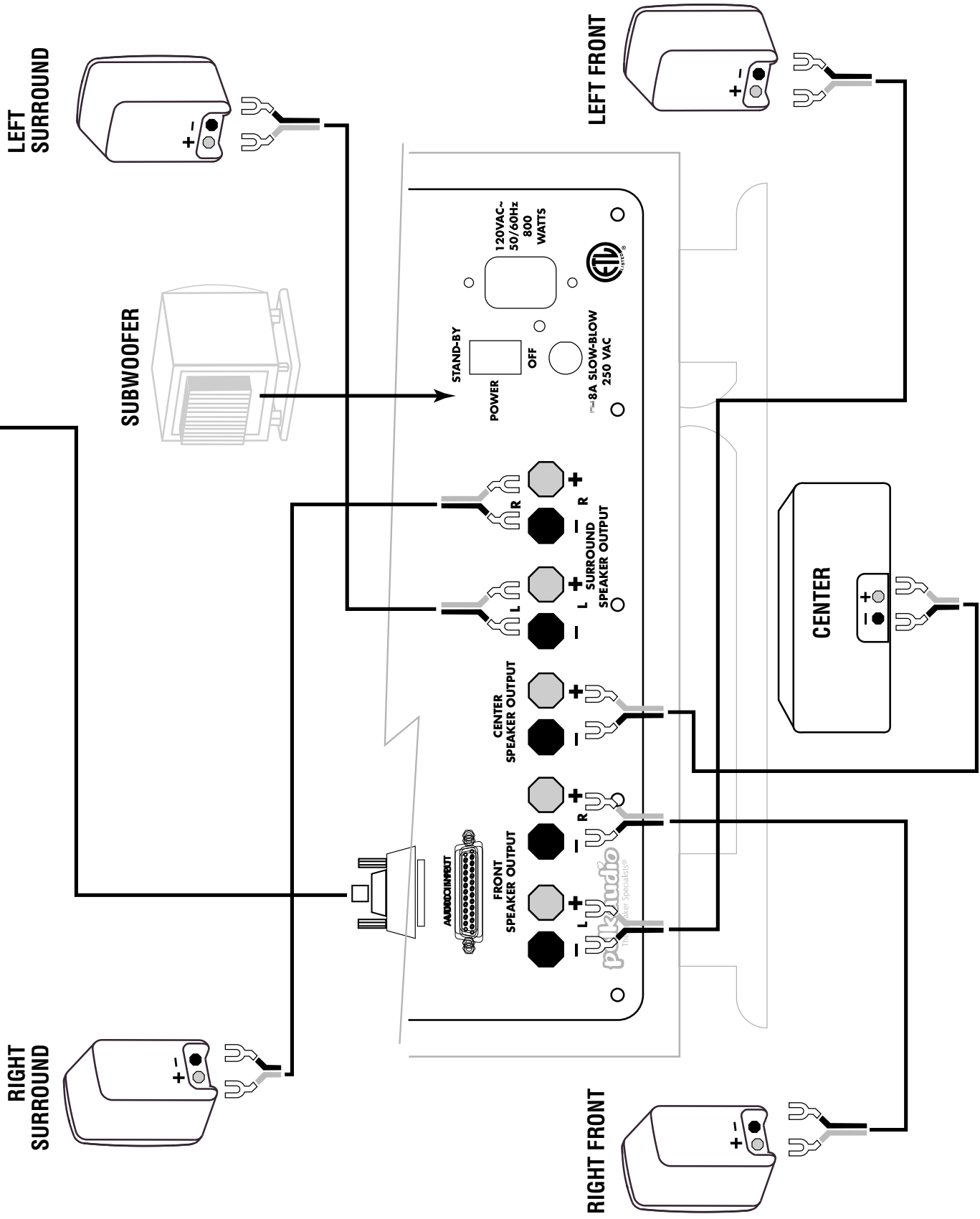

Polk customer service (800) 377-7655 • www.polkaudio.com

RMDS-1 Specifications

System

Overall Frequency Response
30Hz—24kHz

-3dB Frequency Response Limits
38Hz—20kHz

Subwoofer to Satellite/Center Crossover Design
Active 4th order (24dB/octave) low-pass and high-pass,
150Hz acoustic crossover.

Maximum Sound Pressure Level
105 dB in an IEC Standard 80 cubic meter
(2825 cubic foot, e.g. 15'W x 22'L x 8½'H) room

Satellites

Driver Complement:
1-3¼" magnetically shielded midrange driver with polypropylene cone
and butyl rubber surround
1-¾" silk dome tweeter w/neodymium magnet (self shielded)

Crossover Design:
2nd order (12dB per octave slopes, electrical) symmetrical topology;
mid-tweeter crossover @ 3.1 kHz; Mylar film capacitors in tweeter's
signal path.

Dimensions:
4"W x 6¼"H x 5"D

Center Channel

Driver Complement:
2-3¼" magnetically shielded drivers with polypropylene cones and
butyl rubber surrounds
1-¾" silk dome tweeter w/neodymium magnet (self shielded)

Crossover design:
2nd order (12dB per octave slopes, electrical) symmetrical topology;
mid-tweeter crossover @ 2.5 kHz; Mylar film capacitors in tweeter's
signal path.

Dimensions:
11½"W x 4½"H x 5¼"D

Subwoofer

Driver Complement:
1-10" magnetically shielded driver with 1½" voice coil, polypropylene
cone and butyl rubber surround

Crossover design:
Fixed, active 4th order (24dB/octave) low-pass with amplitude shaping

Cabinet Dimensions:
15½"W x 18¾"H x 19½"D

Six Channel Power Amplifier

System Continuous Power Output
Greater than 500 Watts into 4 Ohms,
all channels driven*

Dynamic Power Output:
700 watts into 4 Ohms, all channels driven*

Bandwidth
20Hz-22kHz

Distortion
0.05%

Power Requirement
AC 120V, 50/60Hz

Maximum Power Consumption
800 Watts

Preamp/Processor

FM Tuner Section

Usable Sensitivity	IHF 1.3 eV/13.5dBf
Signal to noise ratio	Mono/Stereo 76/68dB
Distortion	Mono/Stereo 0.2/0.5%
Stereo Separation	1 kHz 40dB
Alternate Channel Selectivity	± 400kHz 65dB
Image Rejection	98 MHz 50dB

AM Tuner Section

Usable Sensitivity:	Loop 500µV
Signal to noise ratio	50dB
Selectivity	± 20kHz 70dB
Image Rejection	98 MHz 50dB

General

Power Requirement	AC 120V 60Hz
Power Consumption (AC-3 RF)	26W
Dimensions (Max)	17¼"W x 4½"H x 14"D

*Power ratings alone cannot predict actual sound output. Loudspeaker efficiency is by far the most important factor in determining how loud your system will play. For this reason we also specify the calculated maximum sound output of the RMDS-1 system in a 2825 cu ft. room (for example, one measuring approximately 15'W x 22'L x 8½'H). The maximum SPL (volume) of the RMDS-1 in such a room would be 105 dB, as loud as a rock band at 150 feet; certainly loud enough to get you evicted from a New York City apartment. There are worse fates.

polk audio
The Speaker Specialists®

**5601 METRO DRIVE,
BALTIMORE, MARYLAND 21215, USA,
410-764-5275, FAX: 410-764-5266
www.polkaudio.com**

RM6608-1

Free Manuals Download Website

<http://myh66.com>

<http://usermanuals.us>

<http://www.somanuals.com>

<http://www.4manuals.cc>

<http://www.manual-lib.com>

<http://www.404manual.com>

<http://www.luxmanual.com>

<http://aubethermostatmanual.com>

Golf course search by state

<http://golfingnear.com>

Email search by domain

<http://emailbydomain.com>

Auto manuals search

<http://auto.somanuals.com>

TV manuals search

<http://tv.somanuals.com>