



▶ Polycom® SoundPoint IP® 670  
Phone User Guide

UC Software 4.0.1 | July 2012 | 1725-12679-001 Rev. D1

---

## Trademark Information

POLYCOM®, the Polycom logo and the names and marks associated with Polycom's products are trademarks and/or service marks of Polycom, Inc. and are registered and/or common law marks in the United States and various other countries. All other trademarks are property of their respective owners. No portion hereof may be reproduced or transmitted in any form or by any means, for any purpose other than the recipient's personal use, without the express written permission of Polycom.

## Patent Information

The accompanying product is protected by one or more U.S. and foreign patents and/or pending patent applications held by Polycom, Inc.

## Disclaimer

Some countries, states, or provinces do not allow the exclusion or limitation of implied warranties or the limitation of incidental or consequential damages for certain products supplied to consumers, or the limitation of liability for personal injury, so the above limitations and exclusions may be limited in their application to you. When the implied warranties are not allowed to be excluded in their entirety, they will be limited to the duration of the applicable written warranty. This warranty gives you specific legal rights which may vary depending on local law.

## Copyright Notice

Portions of the software contained in this product are:

Copyright © 1998, 1999, 2000 Thai Open Source Software Center Ltd. and Clark Cooper

Copyright © 1998 by the Massachusetts Institute of Technology

Copyright © 1998-2003 The OpenSSL Project

Copyright © 1995-1998 Eric Young (eay@cryptsoft.com). All rights reserved

Copyright © 1995-2002 Jean-Loup Gailly and Mark Adler

Copyright © 1996-2004, Daniel Stenberg, <daniel@haxx.se>

Permission is hereby granted, free of charge, to any person obtaining a copy of this software and associated documentation files (the "Software"), to deal in the Software without restriction, including without limitation the rights to use, copy, modify, merge, publish, distribute, sublicense, and/or sell copies of the Software, and to permit persons to whom the Software is furnished to do so, subject to the following conditions:

The above copyright notice and this permission notice shall be included in all copies or substantial portions of the Software.

THE SOFTWARE IS PROVIDED "AS IS", WITHOUT WARRANTY OF ANY KIND, EXPRESS OR IMPLIED, INCLUDING BUT NOT LIMITED TO THE WARRANTIES OF MERCHANTABILITY, FITNESS FOR A PARTICULAR PURPOSE AND NONINFRINGEMENT. IN NO EVENT SHALL THE AUTHORS OR COPYRIGHT HOLDERS BE LIABLE FOR ANY CLAIM, DAMAGES OR OTHER LIABILITY, WHETHER IN AN ACTION OF CONTRACT, TORT OR OTHERWISE, ARISING FROM, OUT OF OR IN CONNECTION WITH THE SOFTWARE OR THE USE OR OTHER DEALINGS IN THE SOFTWARE.

© 2012 Polycom, Inc. All rights reserved.

Polycom, Inc.  
6001 America Center Drive  
San Jose, CA 95164  
USA

No part of this document may be reproduced or transmitted in any form or by any means, electronic or mechanical, for any purpose, without the express written permission of Polycom, Inc. Under the law, reproducing includes translating into another language or format.

As between the parties, Polycom, Inc., retains title to and ownership of all proprietary rights with respect to the software contained within its products. The software is protected by United States copyright laws and international treaty provision. Therefore, you must treat the software like any other copyrighted material (e.g., a book or sound recording). Every effort has been made to ensure that the information in this manual is accurate. Polycom, Inc., is not responsible for printing or clerical errors. Information in this document is subject to change without notice.

---

# About This Guide

Thank you for choosing the Polycom® SoundPoint IP 670, a full-duplex, hands-free SIP desktop phone. This unit provides business telephony features and functions such as multiple call appearances, call hold, transfer, and conference over an IP network.

This guide includes overview information that you may find helpful when you are first learning about your phone, or when you have experience but need a quick refresher. Be sure to verify with your system administrator that your network is prepared for configuring your SoundPoint IP 670 phone. As well, be sure to read the [Getting Started with Your Phone](#) and [Regulatory Notices](#) sections in this guide before you set up and use your SoundPoint IP 670 phone. You can also find this information at <http://www.polycom.com/support/voicedocumentation/>.

## Changes to This Guide

The following sections are new for this edition:

- [Using the Polycom Web Configuration Utility](#) on page 1-8.
- [Locking and Unlocking Your Phone](#) on page 3-26.
- [Logging Into Phones](#) on page 3-28.
- [Broadcasting Messages Using Push-to-Talk and Group Paging](#) on page 3-19.
- [Accessing Features with Your Login Credentials](#) on page 4-26.
- [Updating Your Phone's Configuration](#) on page 4-26.

Major updates have occurred to the following sections since the previous edition:

- [Restarting Your Phone](#) on page 4-27.
- [Customizing Your Phone](#) now starts on page 2-1.

### Note

The SoundPoint IP 670 phone, running UC Software 4.0.1, is not supported for use with Microsoft Lync Server 2010.



---

# Contents

<b>About This Guide</b> . . . . .	<b>iii</b>
Changes to This Guide . . . . .	iii
<b>1 Getting Started with Your Phone</b> . . . . .	<b>1-1</b>
Features of Your Phone . . . . .	1-2
Before You Use Your Phone . . . . .	1-6
Using the Navigation Keys . . . . .	1-6
Information Status . . . . .	1-7
Cleaning the LCD Glass . . . . .	1-7
Registering Your Phone . . . . .	1-8
Using the Polycom Web Configuration Utility . . . . .	1-8
<b>2 Customizing Your Phone</b> . . . . .	<b>2-1</b>
Configuring Basic Settings . . . . .	2-1
Changing the Appearance of the Time and Date . . . . .	2-1
Changing the Display Contrast . . . . .	2-2
Changing the Backlight Intensity . . . . .	2-3
Changing the Backlight Timeout . . . . .	2-5
Enabling Headset Memory Mode . . . . .	2-5
Selecting the Correct Headset for Electronic Hookswitch . . . . .	2-6
Selecting the Ring Type . . . . .	2-7
Changing the Audible Ringer . . . . .	2-8
Changing the Language . . . . .	2-9
Changing the Graphic Display Background . . . . .	2-10
Changing the Soft Key Label Color . . . . .	2-11
Muting the Microphone . . . . .	2-12
Adjusting the Volume . . . . .	2-12
Managing Call Lists . . . . .	2-12
Managing Contacts . . . . .	2-13
Adding Contacts . . . . .	2-14
Editing Contacts . . . . .	2-17

Deleting Contacts .....	2-17
Placing Calls to Contacts .....	2-18
Searching for Contacts .....	2-19
Managing Incoming Calls .....	2-21
Distinguishing Calls .....	2-21
Rejecting Calls .....	2-22
Diverting Calls .....	2-23
System Customizations .....	2-24

### **3 Using the Basic Features of Your Phone .....3-1**

Placing Calls .....	3-2
Answering Calls .....	3-4
Ending Calls .....	3-7
Redialing Numbers .....	3-7
Placing Calls on Hold .....	3-8
Hosting Conference Calls .....	3-9
Setting Up Conference Calls .....	3-9
Managing Conference Calls .....	3-11
Adding Parties to Conference Calls .....	3-14
Joining Conferences .....	3-15
Splitting Conference Calls .....	3-16
Ending Conference Calls .....	3-16
Transferring Calls .....	3-16
Forwarding Calls .....	3-18
Enabling Do Not Disturb .....	3-21
Assigning Speed Dial Keys .....	3-22
Using Voice Mail .....	3-24
Locking and Unlocking the Phone .....	3-25
About Your User Password .....	3-25
Locking and Unlocking Your Phone .....	3-26
Calling and Answering from a Locked Phone .....	3-27
Logging Into Phones .....	3-28
Logging In and Out of a Phone .....	3-28
Placing Calls from Phones that are in the Logged Out State .....	3-30

### **4 Using the Advanced Features of Your Phone .....4-1**

Using Multiple Call Appearances .....	4-1
Using Buddy Lists .....	4-3
Updating Your Presence Settings .....	4-3
Managing Buddies .....	4-4

Recording a Call .....	4-5
Recording Calls .....	4-7
Recording Conferences .....	4-8
Pausing and Resuming Recording .....	4-9
Playing Back a Recorded Call .....	4-10
Browsing Recorded Calls .....	4-11
Playing Back Recorded Calls .....	4-12
Answering a Call While Playing Back Recorded Calls .....	4-13
Broadcasting Messages Using Push-to-Talk and Group Paging .....	4-14
Push-to-Talk Mode .....	4-15
Group Paging Mode .....	4-21
Accessing Features with Your Login Credentials .....	4-26
Updating Your Phone's Configuration .....	4-26
Restarting Your Phone .....	4-27

## **5 Using the SoundPoint IP Color Expansion Module ..... 5-1**

Connecting the SoundPoint IP Color Expansion Module .....	5-2
Features of the SoundPoint IP Color Expansion Module .....	5-3
Adjusting the Display Contrast .....	5-4
Adjusting the Backlight Intensity .....	5-4
Placing Calls .....	5-5
Answering Calls .....	5-5
Assigning Speed Dial Keys .....	5-5
Using the Busy Lamp Field .....	5-7

## **6 Troubleshooting Your Phone ..... 6-1**

Power and Startup .....	6-2
Controls .....	6-2
Access to Screens and Systems .....	6-3
Audio .....	6-4
Calling .....	6-4
Displays .....	6-6
Productivity Suite .....	6-7
Testing Phone Hardware .....	6-7

## **Regulatory Notices ..... Safety Notices-1**

## **End-User License Agreement for Polycom® Software**





---

# Getting Started with Your Phone

This chapter provides basic installation instructions and information for obtaining the best performance with the Polycom® SoundPoint IP 670 desktop phone.

The SoundPoint IP 670 provides a powerful, yet flexible IP communications solution, delivering excellent voice quality. The high-resolution color graphic display supplies content for call information, multiple languages, directory access, and system status. The SoundPoint IP 670 supports advanced functionality, including multiple call and flexible line appearances, HTTPS secure provisioning, simplified configuration, presence, custom ring tones, local conferencing, applications, and Polycom® HD™ Voice technology.

The SoundPoint IP 670 provides a visually improved platform for applications which can leverage its color display.

Powered by state of the art Gigabit Ethernet IP telephony technology, the SoundPoint IP 670 features a future-proof dual-port Gigabit Ethernet switch for seamless integration with a computer or desktop server. For organizations with existing GigE deployment, the SoundPoint IP 670 delivers unobstructed, high-speed access to data and productivity-boosting data and applications. For organizations with plans to migrate to GigE, the SoundPoint IP 670 protects investment in desktop networking.

When equipped with up to three SoundPoint IP Color Expansion Modules, the SoundPoint IP 670 turns into a productivity-enhancing attendant console for attendants to increase call handling capability and to view presence information without the need for a computer.

For the package list and instructions on how to assemble your phone, refer to the *SoundPoint IP 670 Quick Start Guide*.

This chapter contains information on:

- [Features of Your Phone](#)
- [Before You Use Your Phone](#)
- [Features of Your Phone](#)
- [Using the Polycom Web Configuration Utility](#)

To customize your phone, refer to [Customizing Your Phone](#) on page 1-1. To read about the phone's basic features, refer to [Using the Basic Features of Your Phone](#) on page 3-1. To read about the phone's advanced features, refer to [Using the Advanced Features of Your Phone](#) on page 4-1. To add a SoundPoint IP Expansion Module to your SoundPoint IP 670 phone, refer to [Using the SoundPoint IP Color Expansion Module](#) on page 5-1.





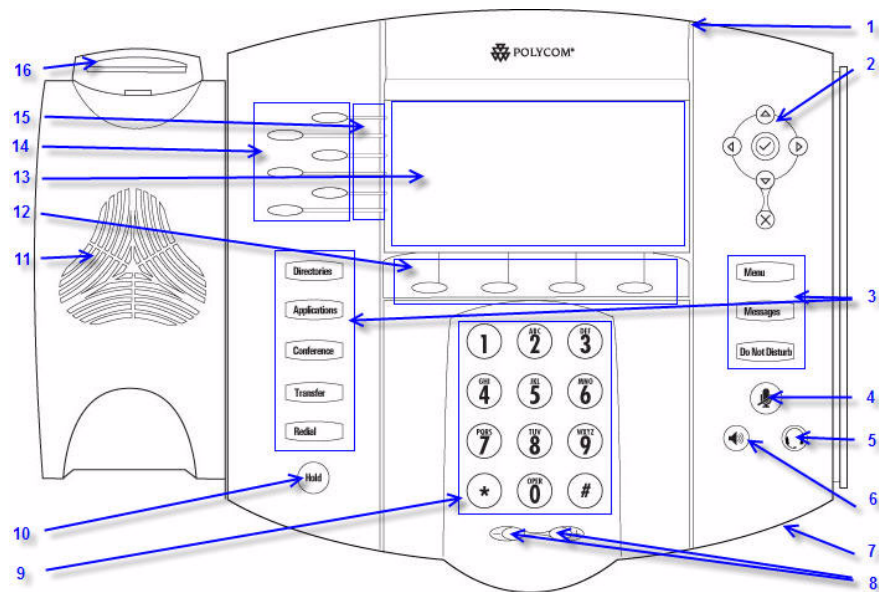

If you require additional information or assistance with your new phone, contact your system administrator.

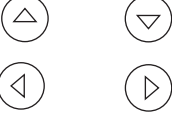

## Features of Your Phone















The features of your SoundPoint IP 670 phone are:

	Item	Description
1	Message Waiting Indicator	Alert for voice and text (instant) messages.

	Item	Description
2	Arrow Keys	
		Scroll through displayed information.
		Select a field of displayed data.
		Delete displayed data.
3	<p><b>Directories</b></p> <p><b>Applications</b></p> <p><b>Conference</b></p> <p><b>Transfer</b></p> <p><b>Redial</b></p> <p><b>Menu</b></p> <p><b>Messages</b></p> <p><b>Do Not Disturb</b></p>	<p>Feature Keys:</p> <p>Allow you to quickly access important features with a single press.</p>
4	<p>Microphone Mute</p> 	Mutes audio transmission locally during calls and conferences.
5	<p>Headset </p>	Allows you to place and receive calls through an optionally connected headset.
6	<p>Speakerphone </p>	Allows for hands-free communication during calls.
7	<p>Hands-free Microphone</p>	Picks up audio during hands-free calls. Place your phone on a hard, flat surface for best results.
8	<p>Volume Keys</p> 	Adjusts the volume of the handset, headset, speaker, and ringer.

	Item	Description
9	Dial Pad	Provides the 10 digits, the alphabetic characters, and special characters available in context-sensitive applications.
10	Hold 	Holds an active call or resumes a held call.
11	Speaker	For ringer and hands-free audio output.
12	Soft Keys	These keys are automatically labeled to identify their context-sensitive functions.
13	Color Graphic Display	Shows the user interface of the phone. For more information, refer to <a href="#">Information Status</a> on page 1-7. Associated line icons are described in the following table.
14	Line/Speed Dial Key 	Use these keys to activate up to six lines or speed dials that can be assigned to your phone.
15	Line Indicators	Individual multi-color LEDs display the dynamic call state and remote user status (busy lamp field (BLF) and presence). The mapping is: <ul style="list-style-type: none"> <li>• Solid green—An active call is in progress.</li> <li>• Fast flashing green—There is an incoming (ringing) call.</li> <li>• Flashing green—The call is held by the other party.</li> <li>• Flashing red—The call is on hold.</li> <li>• Solid red—The line is busy remotely (shared lines)</li> </ul>
16	Hookswitch	

Icons associated with the line keys appear on the graphic display and represent:

Icon	Description
	Registered line (solid)
	Registered shared line
	Unregistered line (outline)
	Voice mail/Text messages
	Speed dial
	Ringing
	Call in progress with HD Voice
	Call in progress
	Call Forward
	Held/On Hold Line
	Do Not Disturb
	Conference
	Presence/Busy Lamp Field (BLF)

## Before You Use Your Phone

This section includes information on how to navigate the phone's menus, how to enter data, how to read the phone's information status bar, and how to clean the color LCD display.

**Note**







The background and key colors that appear on your SoundPoint IP 670 phone may differ from what appears in this user guide.

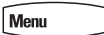
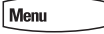

## Using the Navigation Keys

To navigate menus and enter data, use these tips:

**Note**

After 20 seconds of inactivity, the menu system automatically exits to the idle screen unless an edit session is in progress.

If you want to...	Then do this...
Enter the main menu	Press 
Exit a menu to the idle screen	Press 
Exit a directory to the idle screen	Press 
Return to the previous menu	Press  or the <b>Back</b> soft key
Scroll through lists and menus	Press/Hold  or 
Scroll through pages	Press * to Page Up and # to Page Down.
Select a menu item	Highlight the item and press  or  Press the dial pad key that corresponds to the number menu list (Press <b>2</b> for the second menu item)
View additional soft keys	Press the <b>More</b> soft key
Enter numbers	Press the dial pad key with the corresponding number.
Enter text	Press the dial pad keys one or more times. To enter 'A', press <1> once. To enter 'C', press <1> three times quickly.
Enter lower or upper case characters, or numbers.	Press the <b>1/A/a</b> soft key one or more times to select upper/lower case alphanumeric mode or numeric mode (visible in the status bar). Then use the dial pad to enter numbers or text as you normally would.

If you want to...	Then do this...
Enter special characters	Press *, #, <1>, <0> one or more times quickly in alphanumeric mode. Press * or # once or twice quickly in numeric mode. To enter a space, press <0> three times quickly in alpha mode.
Enter an IP address or URL	Press a dial pad key once for numbers and one to four more times quickly for letters.
Change the character set	Press the <b>Encoding</b> soft key to select the character set (shown in the title bar) for the text being entered.
Delete characters you entered	Press 
Toggle to enable or disable fields	Toggle 
Enable or disable menu items	Press 

## Information Status

The top line of the screen (or graphic display) shows status information. It scrolls vertically if there is more than one message. The information bar also shows items such as time and date, do not disturb (shown below), and missed calls.

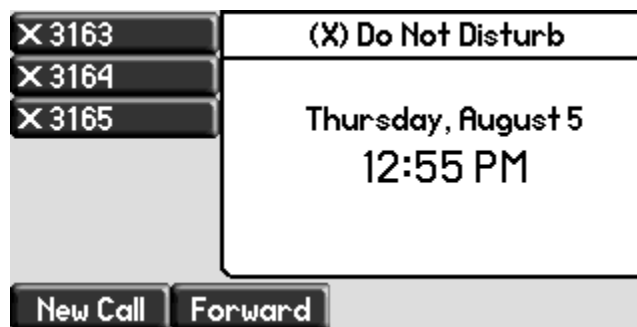

## Cleaning the LCD Glass

Clean the glass with a clean lint-free cloth. Fingerprints tend to show up more obviously on the color LCD.

## Registering Your Phone

Generally, your phone will be deployed with multiple other phones. In this case, your system administrator will configure the phone parameters beforehand, so that once it is set up, it will be registered and ready to use.

If your phone is not part of a large deployment, it may not be registered after you set it up. Before you use your phone, you or your system administrator will have to register it.

For detailed information on how to register your phone after you install it, refer to Quick Tip 44011 *Registering Standalone SoundPoint IP, SoundStation IP, and Polycom VVX Phones*, available from

[http://www.polycom.com/usa/en/support/voice/soundpoint\\_ip/VoIP\\_Technical\\_Bulletins\\_pub.html](http://www.polycom.com/usa/en/support/voice/soundpoint_ip/VoIP_Technical_Bulletins_pub.html).

## Using the Polycom Web Configuration Utility

This user guide explains how to update phone settings from your phone, using your phone's menu system. If you want, you can update these settings remotely with the Polycom Web Configuration Utility.

The phone's Web Configuration Utility enables you to view and configure phone behavior from a computer using any compatible Web browser. The utility provides a browser-friendly view of your phone's current settings. Using the utility, you can perform the same updates from your computer that you can perform using your phone's menu system.

You can access the utility using any compatible Web browser. Before you begin, you'll need to know the IP address of your phone, and the user name and password login credentials of the phone user or the phone administrator.

### Note

For detailed information on accessing, navigating, and using the utility, see the *Polycom Web Configuration Utility User Guide*, available from the [Technical Bulletins Support](#) page

### To access the Web Configuration Utility for your phone:

- 1 Launch the compatible Web browser from a computer on the same network as your phone. The supported browsers are:
  - Microsoft Internet Explorer (version 7.0 and higher)
  - Mozilla Firefox (version 3.0.X and higher)
  - Apple Safari (version 5 and higher)
  - Google Chrome



- 2 In the Address Bar of your Web Browser, enter the IP address of your phone.

The IP address is four sets of numbers separated by periods. For example, if your phone's IP address is 123.22.3.4, enter **123.22.3.4** in the address bar.

- 3 Press the **Enter** key.
- 4 From the Web Configuration Utility login screen, select **User**, and then enter the User password.

**Note**

The factory default password for a User is 123.

- 5 Click **Submit**.

The Web Configuration Utility Home screen is displayed.



---

# Customizing Your Phone

You can customize your Polycom® SoundPoint IP 670 desktop phone by adjusting settings such as: time and date, display contrast, and ring type. You can add contacts to the phone's directory manually or from call lists. You can handle incoming calls from different contacts in different ways.

This chapter provides basic operating instructions for customizing your SoundPoint IP 670 phone. The topics include:

- [Configuring Basic Settings](#)
- [Managing Call Lists](#)
- [Managing Contacts](#)
- [Managing Incoming Calls](#)

Some customizations of your SoundPoint IP 670 phone are performed by your system administrator. For more information about these customizations, refer to [System Customizations](#) on page 2-24.

If you require additional information or assistance with your new phone, contact your system administrator.

## Configuring Basic Settings

You can configure basic settings such as appearance of the time and date, display contrast, backlight intensity, headset memory mode, headset hookswitch selection, ring type, audible ringer, language support localization, background pattern and soft key label color through the phone's menu.

## Changing the Appearance of the Time and Date

The time and date appears on the graphic display of the SoundPoint IP 670 phone. If the phone cannot obtain a time and date from the call server, the display will flash. Contact your system administrator if either the time or date is incorrect.

You can select from various formats for the time and date display. You can also disable the time and date so they do not display on the phone.



**To configure the time and date formats:**

1. Press  .
2. Select **Settings > Basic > Preferences > Time & Date**.
3. Select from **Clock Date**, **Clock Time** (shown below), **Clock Order**, or **Enable/Disable**.
4. Scroll through the options under each of these selections.

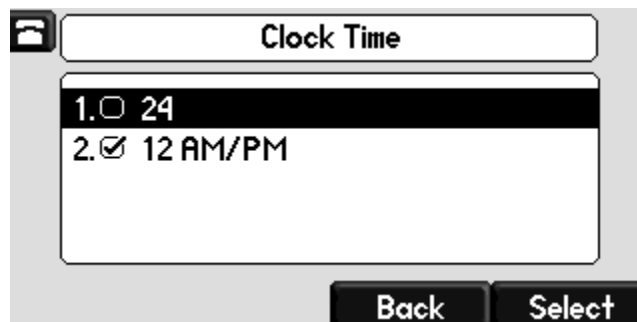

5. Press the **Select** soft key to confirm your choice.
6. Press  to return to the idle screen.

## Changing the Display Contrast

You may adjust the contrast of the phone display and the idle display separately.

**To adjust the contrast on the phone display:**

1. Press  .

2. Select **Settings > Basic > Contrast**.

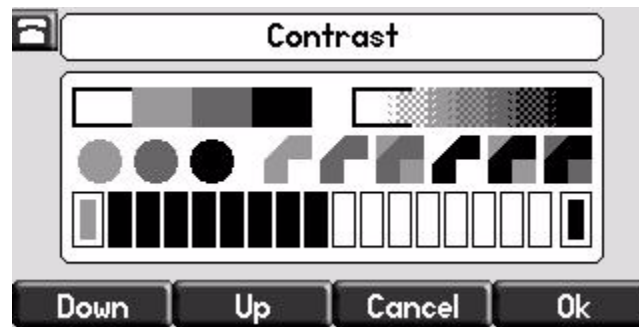

3. Press the **Up** or **Down** soft keys, or the volume keys, to increase or decrease the display contrast.
4. Press the **Ok** soft key to accept your changes.
5. Press  to return to the idle screen.

#### To adjust the contrast on the expansion module:

Perform the same steps as above, except press the **Up** or **Down** soft keys on the expansion module to change its contrast.

## Changing the Backlight Intensity

Backlight intensity on the SoundPoint IP 670 phone has three components:

- Backlight On
- Backlight Idle
- Maximum Intensity

You can modify the Backlight On Intensity and the Backlight Idle Intensity separately. You can choose a high, medium, or low intensity, or turn the backlight off entirely.

When you modify the Maximum Intensity, you are modifying the entire backlight intensity scale. For example, if you decrease the Maximum Intensity, the low, medium, and high values for the Backlight On intensity and the Backlight Idle intensity will decrease proportionally.

If you have attached any expansion modules and you find the backlight levels between them and your phone are incompatible, you can modify the maximum backlight intensity for each unit individually to match all backlights to an overall consistent level. Refer to step 8 below for details.

The backlight automatically turns on with any button, soft key, hookswitch, USB, or telephony activity. After 20 seconds of inactivity, the backlight dims to its idle intensity.

**To modify the backlight intensity:**

1. Press .
2. Select **Settings > Basic > Backlight Intensity**.
3. Select **Backlight On Intensity**.



4. Scroll to select high (default), medium, low, or off, and then press the **Select** soft key. Press the **Save** soft key to accept your changes.
5. Select **Backlight Idle Intensity**.



6. Scroll to select high, medium, low (default), or off, and then press the **Select** soft key. Press the **Save** soft key to accept your changes.
7. Select **Maximum Intensity**.

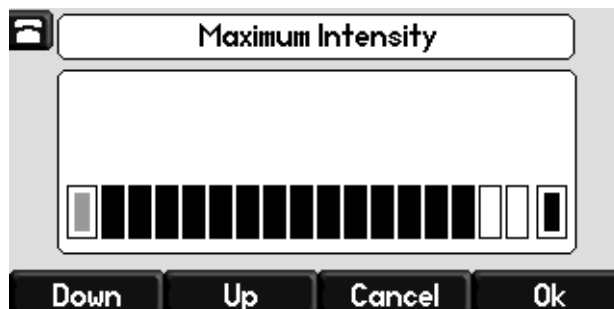

8. To increase or decrease the maximum backlight intensity on the phone's display, press the **Up** or **Down** soft keys.

To increase or decrease the maximum backlight intensity on the expansion module, press the **Up** or **Down** soft keys on the expansion module.

The backlight intensities for the On and Idle modes, as well as the backlight intensities between each expansion module and the phone's screen are shown relative to these values.

9. Press the **Ok** soft key to accept your changes.
10. Press  to return to the idle screen.

## Changing the Backlight Timeout

You can change the length of time your phone is idle before the backlight changes to the Backlight Idle Intensity.

**To change the backlight timeout:**

1. Press .
2. Select **Settings > Basic > Backlight Timeout**.

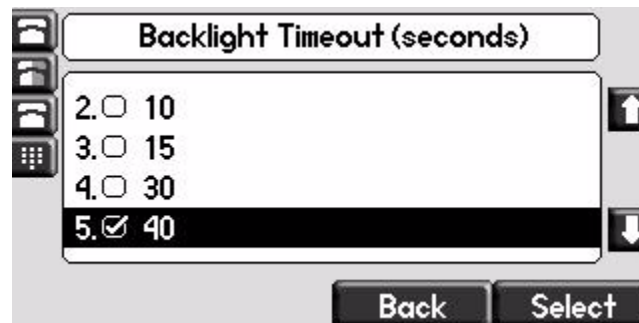

3. From the Backlight Timeout screen, scroll to the timeout you want, then press the **Select** soft key.

The default timeout is 40 seconds.

4. Press  to return to the idle screen.

## Enabling Headset Memory Mode

This feature is especially useful for frequent or full-time headset users. You can set up your phone so that all incoming and outgoing calls use your headset. At any time, you can switch to handset or speakerphone mode.

To use Headset Memory Mode, you must enable, and then activate, Headset Memory Mode. When Headset Memory Mode is activated, the Headset key flashes.

#### To enable Headset Memory Mode:

1. Press .
2. Select **Settings > Basic > Preferences > Headset > Headset Memory**
3. Scroll to select **Enabled**, and then press the **Select** soft key.

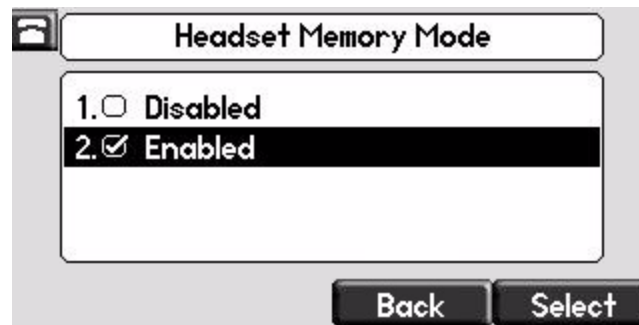

4. Press  to return to the idle screen.

Repeat steps 1 to 4 and select Disabled to turn Headset Memory Mode off.

#### To activate Headset Memory Mode:

- >> Press  twice.

The flashing headset icon on the graphic display or a flashing headset key indicates that the headset mode is activated. Pressing  or the **Answer** soft key to receive a call will now connect to your headset automatically.

## Selecting the Correct Headset for Electronic Hookswitch

This feature allows you to answer your phone from your headset if you are using one.





For information on headsets that provide Polycom supported electronic hookswitch features for placing, answering, and ending calls, refer to Technical Bulletin 37477 *SoundPoint IP Family Headset Compatibility List*, available from [http://www.polycom.com/support/voice/soundpoint\\_ip/VoIP\\_Technical\\_Bulletins\\_public.html](http://www.polycom.com/support/voice/soundpoint_ip/VoIP_Technical_Bulletins_public.html)

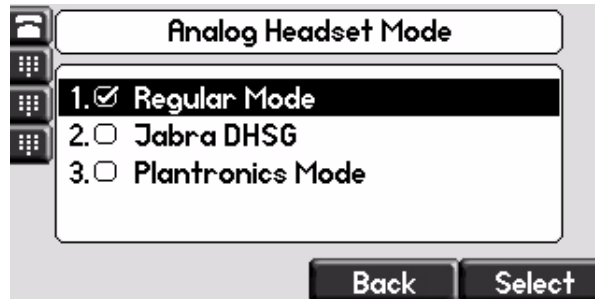

**To select a headset that supports electronic hookswitch:**

1. Press .
2. Select **Settings > Basic > Preferences > Headset > Analog Headset**.
3. Scroll to select your headset, and then press the **Select** soft key.



4. Press  to return to the idle screen.

## Selecting the Ring Type

You can select different ring types to distinguish different lines or phones from each other.

**To change the incoming ring type:**

1. Press .
2. Select **Settings > Basic > Ring Type**.
3. If multiple lines are configured on your phone, scroll to the desired line and select it.
4. Scroll to select the desired ring type.

To hear the selected ring type, press the **Play** soft key.



5. Press the **Select** soft key to change to the selected ring type.

6. Press  to return to the idle screen.

**Note**

If you configure your SoundPoint IP 670 phone with a silent ring, press the flashing Line key or the **Answer** soft key to answer the call. If your handset is off hook, the call is routed to the handset. If your handset is on hook, the call is routed to the speaker.

## Changing the Audible Ringer

The SoundPoint IP 670 phone can play the audible ringer of an incoming call through any of its alerting destinations: the speaker, the handset, the headset (if enabled), or the active destination.

**Note**

If the **Active** destination is selected, the audible ringer is played through:

- The speaker, by default.
- The handset, if it is off-hook and the phone is idle.
- The headset, if it is connected and Headset Memory Mode is enabled (refer to [Enabling Headset Memory Mode](#) on page 2-5).

### To change the audible ringer:

1. Press .
2. Select **Settings > Basic > Preferences > Audible Ringer**.
3. Scroll to select the desired ring destination.

Choose Speaker, Handset, Headset, or Active as the alerting destination for the audible ringer.



4. Press the **Select** soft key to change to the selected audible ringer.
5. Press  to return to the idle screen.

## Changing the Language

The SoundPoint IP 670 phone supports many languages.

### To change the language:

1. Press .
2. Select **Settings > Basic > Preferences > Language**.
3. Scroll to highlight the language you want.

You can choose from Chinese, Danish, Dutch, English (Canada), English (United Kingdom), English (United States), French, German, Italian, Japanese, Korean, Norwegian, Polish, Portuguese, Russian, Slovenian, Spanish, and Swedish.



4. Press the **Select** soft key to change to the highlighted language.

Text that appears on the graphic display will change to the language of your choice.

5. Press  to return to the idle screen.

## Changing the Graphic Display Background

You can change the picture or design that appears on the graphic display. A default background displays when the phone starts up (shown below). For more information on selections, contact your system administrator.



To change the graphic display background:

1. Press .
2. Select **Settings > Basic > Preferences > Background**.

### Note

Under certain circumstances, you may need to make an additional menu selection, **Select Background**, to actually select the background.

If your system administrator has configured the phone's idle browser and you want to view the background and not the idle browser, you can turn off the idle browser by doing the following:

- Select **Background > Prioritize Background**.
- Select **Enable** and press the **Select** soft key.

3. Scroll to highlight the background you want.



### Note

When previewing the backgrounds, only the phone's display is updated. The Expansion Module's display is updated only when the new background is selected.

4. Press the **Select** soft key to change to the highlighted background.
5. Press  to return to the idle screen.

## Changing the Soft Key Label Color

You can change the soft key label color that appears on the graphic display. A default soft key label color displays when the phone starts up (shown below). For more information on selections, contact your system administrator.



To change the soft key label color:

1. Press .
2. Select **Settings > Basic > Preferences > Label Color**.

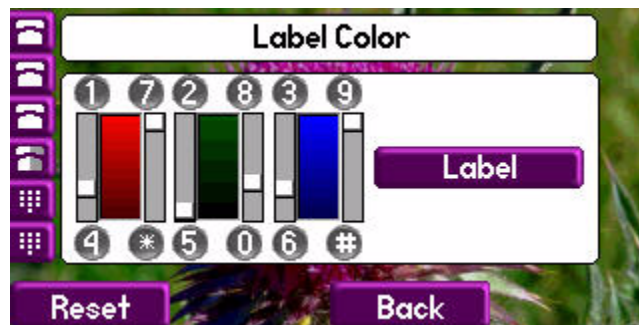

Using the dial pad keys 1, 4, 7, and \* change the red hues. Using the dial pad keys 2, 5, 8, and 0 change the green hues. Using the dial pad keys 3, 6, 9, and # change the blue hues. The **Label** preview soft key on the right reflects your changes.

### Note

When the color of the label reaches a certain level of whiteness, "Cannot save this color. Text might be unreadable." appears and you are unable to save your changes. This warning appears only the first time the color reaches that level.

3. Press the **Save** soft key to accept your changes.

4. Press  to return to the idle screen.

## Muting the Microphone

During a call, press . The Message Waiting Indicator turns red and a microphone on the screen indicates that the other party (or parties) cannot hear you.

Microphone Mute applies to all calling modes. You can still hear all other parties while mute is enabled.

To turn off Microphone Mute, press  again.

## Adjusting the Volume

Press  to adjust receiver volume during a call. Pressing these keys in the idle state adjusts the ringer volume.

### Note

To conform to regulatory requirements, handset and headset volume will return to a preset level after each call, unless your system administrator changes this. Hands-free Speakerphone volume settings will be maintained across calls.

## Managing Call Lists

Your phone maintains local lists of missed, received, and placed calls. Each list can contain up to 100 entries.

Press  followed by **Call Lists > Missed Calls, Received Calls, or Placed Calls** (shown below).



Manage the call list by doing the following:

- To edit the phone number, press the **Edit** soft key.

- To return the call, press the **Dial** soft key.
- To view information about the call, press the **More** soft key followed by the **Info** soft key.
- To store the contact in the Contact Directory, press the **More** soft key followed by the **Save** soft key.
- To delete the call from list, press the **More** soft key followed by the **Clear** soft key.

Press  to return to the idle screen.

#### Note

Press the **Right** arrow key from the idle screen to access the Placed Calls list. Press the **Left** arrow key from the idle screen to access the Received Calls list. Press the **Down** arrow from the idle screen to access the Missed Calls list. You can use these shortcuts while placing calls or performing transferring and conferencing functions.

#### Note

You can manually clear call lists by pressing the **Directories** key and then selecting **Call Lists > Clear**. They are also automatically cleared when you restart the phone.

## Managing Contacts

You can store a large number of contacts in your phone's local contact directory, accessible by pressing  and selecting **Contact Directory**.

You can dial or search for a contact in this directory. You may be able to add, edit, and delete contacts.



You may have access to portions of your corporate directory through your phone. The contacts that you can see are determined by your system administrator. You can place calls to contacts in your corporate directory. You may be able to add contacts from the corporate directory to your local contact directory.

## Adding Contacts

You can add contacts to your contact directory manually, from a call list, or from your corporate directory (if enabled).

### Adding Contacts Manually

**To add a contact to the local contact directory manually:**

1. Press .
2. Select **Contact Directory**.
3. Press the **More** soft key.
4. Press the **Add** soft key.
5. Enter first and/or last name of the contact from the keypad.

Use the **1/A/a** soft key to select between numeric and upper/lower case alphanumeric modes.

Use the **Encoding** soft key to access special characters in other languages.



6. Enter a contact number.  
This is a required field and it must be unique (not already in the directory).
7. (Optional.) Change the Speed Dial Index.

It is automatically assigned to the next available index value. You may instead enter any unused speed dial number from 1 to 9999.

For more information, refer to [Assigning Speed Dial Keys](#) on page 3-22.



8. (Optional.) Change the Ring Type and Divert Contact.

These fields may be left blank.

For more information on setting the Ring Type field, refer to [Distinguishing Calls](#) on page 2-21.

For more information on diverting contacts, refer to [Diverting Calls](#) on page 2-23.



9. (Optional.) Change the Auto Reject, Auto Divert, Watch Buddy, and Block Buddy.

Toggle to switch between Enabled and Disabled.

For more information on setting the Auto Reject field, refer to [Rejecting Calls](#) on page 2-22. For more information on setting the Watch Buddy and Block Buddy fields, refer to [Managing Buddies](#) on page 4-4.

10. Press the **Save** soft key to accept your changes.

11. Press **Directories** to return to the idle screen.

### Adding Contacts From Call Lists

#### To add a contact to the local contact directory from a call list:

1. Do one of the following:
  - a Press **Directories**, and then select **Call Lists >Missed Calls**, **Received Calls**, or **Placed Calls** as desired.
  - b Use a **◀**, **▶**, or **▽** shortcut from the idle menu.
2. Scroll to highlight the contact.

You can also use the \* key to Page Up and the # key to Page Down.

3. Press the **More** soft key, and then the **Save** soft key to save the contact in the phone's directory.



4. Press **Directories** to return to the idle screen.

### Adding Contacts From the Corporate Directory

To add a contact to your local contact directory from the corporate directory:

1. Press **Directories**.
2. Select **Corporate Directory**.
3. Search for the contact.  
Refer to [Searching the Corporate Directory](#) on page 2-19.
4. Press the **View** soft key.

The contact's information appears on the graphic display.



5. Press the **Save** soft key to save the contact in the local contact directory.  
"Entry saved" appears on the graphic display. Only the first name, last name, and phone number are saved.
6. Press **Directories** to return to the idle screen.

## Editing Contacts

### To edit a contact in the local contact directory:

1. Press **Directories**.
2. Select **Contact Directory**.
3. Scroll to highlight the contact.  
You can also use the \* key to page up and the # key to page down.
4. Press the **Edit** soft key
5. Edit the contact information.



6. Press the **Save** soft key to accept your changes.
7. Press **Directories** to return to the idle screen.

#### Note

You can quickly edit a contact associated with a speed dial key by pressing and holding the contact's speed dial key, and then performing steps 5 to 7.

## Deleting Contacts

### To delete a contact from the local contact directory:

1. Press **Directories**.
2. Select **Contact Directory**.
3. Scroll to highlight the contact.  
You can also use the \* key to page up and the # key to page down.
4. Press the **More** soft key followed by the **Delete** soft key.  
The contact is deleted from the directory.

5. Press  to return to the idle screen.

## Placing Calls to Contacts

### Placing Calls From the Contact Directory

To place a call to a contact in the local contact directory:

1. Press  .
2. Select **Contact Directory**.
3. Scroll to highlight the contact.  
You can also use the \* key to page up and the # key to page down.
4. Press the **Dial** soft key.

### Placing Calls From the Corporate Directory

To place a call to a contact in the corporate directory:

1. Press  .
2. Select **Corporate Directory**.
3. Search for the contact.  
Refer to [Searching the Corporate Directory](#) on page 2-19.
4. Press the **View** soft key.

The contact's information appears on the graphic display.



5. Press the **Dial** soft key.

## Searching for Contacts

You can search for contacts in the local contact directory and the corporate directory.

### Searching the Contact Directory

To search for a contact in the local contact directory:

1. Press **Directories**.
2. Select **Contact Directory**.
3. Press the **More** soft key, and then the **Search** soft key.
4. Using the dial pad, enter the first few characters of the contacts's first or last name.



5. Press the **Search** soft key again.

You can dial any successful matches from the resulting information on the graphic display.

### Searching the Corporate Directory

To search for a contact in the corporate directory (if enabled):

1. Press **Directories**.
2. Select **Corporate Directory**.

#### Note

Your phone can remember and display the person or search you were last viewing every time you open the corporate directory. To enable this feature, press the **Menu** key, and then select **Settings > Basic > Preferences > Corporate Directory > View Persistency**. Select **Enabled**, press the **Select** soft key, and then press the **Menu** key to exit the menu.

3. Search for the contact in one of the following ways:

- In the search line, enter the first few characters of the contacts' last name using the dial pad. For example, to search for Carol Woller, enter **wo** in the search line.



Press the **Submit** soft key. In this example, Carol Woller appears in the search results.



If no entries in the corporate directory match the search parameters, "No entries found." appears.

- Press the **AdvFind** soft key, enter search values in the displayed fields. For example, enter **Byron Smith** as the first name and last name.

Press the **Submit** soft key. In this example, Byron Smith appears in the search results.

You can dial any successful matches from the resulting information on the graphic display.

## Managing Incoming Calls

You can distinguish incoming calls by setting distinctive rings for contacts in your contact directory, sending particular calls directly to your voice mail, or transferring particular calls to another party.

### Distinguishing Calls

You can customize your phone so that you can distinguish different parties by ring type.

#### Note

This feature is local to the phone, and may be overridden by your organization's settings. For more information, contact your system administrator.

### To set a distinctive ring type for a contact:

1. Press **Directories**.
2. Select **Contact Directory**.
3. Scroll to highlight the contact.  
You can also use the \* key to page up and the # key to page down.
4. Press the **Edit** soft key, and then scroll down to the Ring Type field.



5. Navigate Left or Right to select the desired Ring Type.  
For more information, refer to [Selecting the Ring Type](#) on page 2-7.  
To remove a distinctive ring, or have no distinctive ring, navigate Left to the blank entry.
6. Press the **Save** soft key to accept your changes.
7. Press **Directories** to return to the idle screen.

## Rejecting Calls

You can customize your phone so that incoming calls from a particular party are immediately sent to your voice mail.

### Note

Calls on shared lines can be silenced using the **Silence** soft key or the **Do Not Disturb** key. They cannot be rejected.

### To send incoming calls from a contact directly to voice mail:

1. Press **Directories**.
2. Select **Contact Directory**.
3. Scroll to highlight the contact.  
You can also use the \* key to page up and the # key to page down.



4. Press the **Edit** soft key, and then scroll down to the Auto Reject field.



5. Toggle to select Enabled.
6. Press the **Save** soft key to accept your changes.
7. Press **Directories** to return to the idle screen.

## Diverting Calls

You can customize your phone so incoming calls from a particular contact are transferred directly to a third party.

### To divert incoming calls from a particular contact:

1. Press **Directories**.
2. Select **Contact Directory**.
3. Scroll to highlight the contact.  
You can also use the \* key to page up and the # key to page down.
4. Press the **Edit** soft key, and then scroll down to the Divert Contact field.



5. Enter the number of the party to whom you want to divert the call.
6. Scroll down to the Auto Divert field.
7. Toggle to select Enabled.

8. Press the **Save** soft key to accept your changes.
9. Press  to return to the idle screen.

## System Customizations

Support for multiple lines, multiple line keys per line, or shared lines can be configured by your system administrator. See your system administrator for details regarding these customizations.

---

# Using the Basic Features of Your Phone

Your Polycom® SoundPoint IP 670 desktop phone is designed to be used like a regular phone on a public switched telephone network (PSTN). You call place a call, transfer a call to someone else, or conduct a conference call.

At any time, at most one active call may be in progress on your phone. The active call is the one that has audio associated with it. There may be multiple other calls on hold in an “Incoming call” or “Ringing” state.

This chapter provides basic operating instructions for the SoundPoint IP 670 phone. The topics include:

- [Placing Calls](#)
- [Answering Calls](#)
- [Ending Calls](#)
- [Redialing Numbers](#)
- [Placing Calls on Hold](#)
- [Hosting Conference Calls](#)
- [Transferring Calls](#)
- [Forwarding Calls](#)
- [Enabling Do Not Disturb](#)
- [Assigning Speed Dial Keys](#)
- [Using Voice Mail](#)
- [Locking and Unlocking the Phone](#)
- [Logging Into Phones](#)

To customize your phone, refer to [Customizing Your Phone](#) on page 2-1. To read about the phone's advanced features, refer to [Using the Advanced Features of Your Phone](#) on page 4-1. To add a SoundPoint IP Expansion Module to your SoundPoint IP 670 phone, refer to [Using the SoundPoint IP Color Expansion Module](#) on page 5-1.

If you require additional information or assistance with your new phone, contact your system administrator.



## Placing Calls



You can place a call using your SoundPoint IP 670 phone over the handset, speakerphone, or headset.

You can dial the number first, and then choose the method you will use to speak to the other party.

You can also search the call lists, the local contact directory or the corporate directory and dial from the search results page. For more information, refer to [Managing Call Lists](#) on page 2-12 and [Managing Contacts](#) on page 2-13.

You can place a call from your buddy list or privacy list if enabled. For more information on buddy and privacy lists, see [Calling Your Buddies](#) on page 3-59.

During a call, you can alternate between Speakerphone Hands-Free, Headset, or Handset modes by pressing the  or  keys, or picking up the handset.

The name of the called party is displayed in the active window on the call screen. If it is too long to fit on the screen, you can press  and  to scroll horizontally to view the full name.

The duration of calls is visible on the call screen. In the figure below, the call to Greg Slowski has lasted 30 seconds so far.



**To place a call using the handset:**

>> Do the following steps in any order:

- Pick up the handset.
- Dial the number using the dial pad.

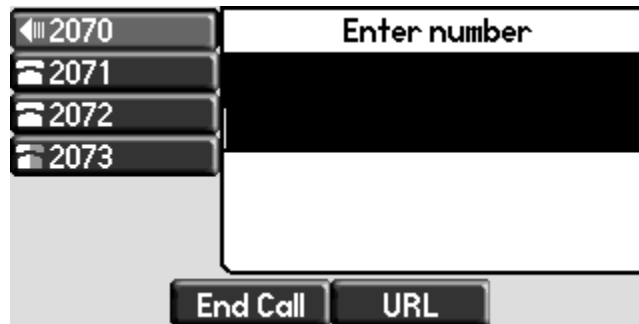
**Note**



You can also dial using the SIP URL or IP address. To obtain the IP address of your phone, press the **Menu** key, and then select **Status > Platform > Phone**. The IP address is listed together with other phone information. The maximum URL or IP address length is 32 characters. For example, 10.3.0.42, sip:jane@polycom.com . Press the **URL** soft key and enter the URL or IP address. Use \* for "." and # for "@". Then press the **Send** soft key to complete the call.

Your phone may not support SIP URL or IP address dialing. Contact your system administrator.

**To place a call using the Hands-Free Speakerphone:****Note**

If "Handsfree mode disabled" appears on the graphic display after you press the speakerphone key, your system administrator has disabled the speakerphone on your phone.

>> Do one of the following:

- With the handset on-hook, press , , or the **New Call** soft key to obtain a dial tone.

Dial the number using the dial pad.

- With the handset on-hook, dial the number using the dial pad.

Press , , or the **Dial** soft key.

### To place a call using the headset:

>> Do one of the following:

- With the optional headset connected, press  or the **New Call** soft key to obtain dial tone.

Press .

Dial the desired number using the dial pad.

- With the optional headset connected, dial the desired number using the dial pad.

Press .

#### Note

If you frequently use a headset, and would like to make it the default call path, refer to [Enabling Headset Memory Mode](#) on page 2-5.

## Answering Calls

When you receive an incoming call, the phone rings (if enabled) and shows the identification of the caller on the display. If a caller's name is too long to fit on the screen, such as Alexander Smith-Harrington's below, it will automatically scroll horizontally across the display.

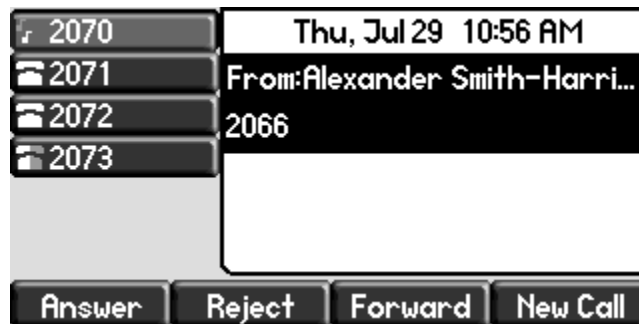

When you are not in another call, you can answer a call using the handset, the speakerphone, or the headset(if enabled).

The steps for answering an incoming call when you are in another call are different if your phone is configured for:

- A single Line Key per line



- Multiple Line Keys per line

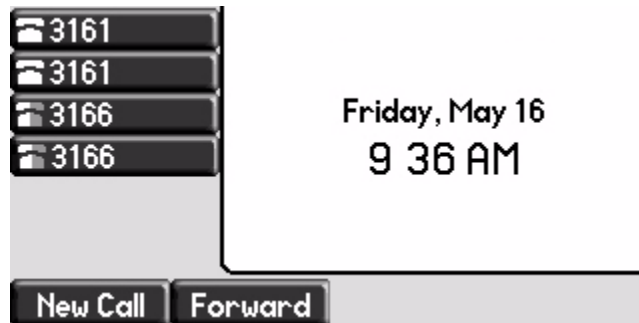

If your phone is configured with multiple call appearances, refer to [Using Multiple Call Appearances](#) on page 4-1 for instructions on how to answer a call.

#### Note

You can ignore incoming calls by pressing the **Reject** soft key (for private lines), the **Silence** soft key (for shared lines), or the **Do Not Disturb** key. Do Not Disturb mode stays active when the call ends and remains active until you press the **Do Not Disturb** key again.

You can forward incoming calls by pressing the **Forward** soft key. For more information, refer to [Dynamic Forwarding](#) on page 3-21.

When your phone is configured with a silent ring, press the ringing Line key or the **Answer** soft key to answer the call. By default, if your handset is off-hook, the call is routed to it. If your handset is on-hook, the call is routed to the speaker.

#### Answering When Not in Another Call

In all cases, the active call will appear on the graphic display showing call duration and destination.

#### To answer a call using the handset:



>> Pick up the handset.

### To answer a call using the Hands-Free Speakerphone:

#### Note

If “Handsfree mode disabled” appears on the graphic display after you press the speakerphone key, your system administrator has disabled the speakerphone on your phone.

>> Do one of the following:

- Press .
- With the handset on-hook, press  (next to the flashing green status indicator).
- Press the **Answer** soft key.

### To answer a call using the headset:

>> Press .

If Headset Memory Mode is activated, press  or the **Answer** soft key.

### Answering When in Another Call

If you have an active call, and an incoming call arrives:

- Regardless of line configuration:
  - You may hear a call waiting tone.  
The line with the incoming call will display the incoming call icon.
  - Press  or the **Hold** soft key to put the original call on hold.  
The incoming call will be displayed at the top of the call screen and the phone will ring.  
Press the **Answer** soft key or the flashing green line key to answer the call.
- If your phone is configured for a single Line Key per phone line:
  - The incoming call will be shown in the call list below the active call.
  - Scroll down to the incoming call, and press the **Answer** soft key or the line key to answer it.
- If your phone is configured for a multiple Line Key per phone line:
  - The line key below the active call will flash green to signal the incoming call.  
To see information about the caller, hold down the flashing line key for at least two seconds.





- To answer the call, press the line key.  
If you hold the line key, you can bring up the caller's information and press the **Answer** soft key to answer the call.

## Ending Calls

### To end a call:

>> Do one of the following:

- Press the **End Call** soft key.
- Replace the handset, if you are using it.
- If you are using a headset, press .
- If you are using the speakerphone, press .
- Press the  of the active call (if enabled by your system administrator).

## Redialing Numbers

### To redial the last call placed from your phone:

>> Press .

A call to your most recently dialed number is attempted.



To redial an older previously placed call, refer to [Managing Call Lists](#) on page 5-12.

## Placing Calls on Hold

During a call, press  or the **HOLD** soft key. The hold icon will display on the line key label.





Press  again or the **Resume** soft key to retrieve the call. The registered line icon appears as the line indicator.

### Note

The Hold feature typically generates music or a beeping tone. Therefore, avoid putting a conference call on hold. Use the mute button instead.

### Multiple Calls on Hold

If multiple calls are on hold on a single Line Key, use  and  to switch between the calls, and then press the **Resume** soft key to retrieve the desired call.



If more than two calls are on hold on a single Line Key, an indication appears on the graphic display, for example "2/3", indicating that this is the second call out of three calls.

If calls are on hold on more than one Line Key, you can view the details of the calls on any Line Key by pressing and holding the Line Key for more than two seconds. If a Line Key is depressed for less than one second, the first call on hold on that Line Key will be retrieved.

## Hosting Conference Calls

You can create a conference with other parties using the phone's local conference feature. You can create a conference at any time between an active call and a call on hold (on the same or another line) by pressing the **Join** soft key. The conference management feature allows you to view all parties in a conference call. From the Manage Conference page, you can add, hold, remove, and mute specific conference parties.

### Note

The conference management feature is an optional feature and may not be supported on your particular system. For more information, contact your system administrator.

This section provides the following step-by-step instructions:

- [Setting Up Conference Calls](#)
- [Managing Conference Calls](#)
- [Adding Parties to Conference Calls](#)
- [Joining Conferences](#)
- [Splitting Conference Calls](#)
- [Ending Conference Calls](#)

## Setting Up Conference Calls

### To set up a conference call:

1. Call the first party.

### Note

You can either dial the phone number directly or search for the number in the Contact Directory or Call Lists. For more information, refer to [Placing Calls](#) on page 3-2, [Searching for Contacts](#) on page 2-19, or [Managing Call Lists](#) on page 2-12.

2. Press **Conference** or the **Confrnc** soft key to create a new call.

The active call is placed on hold.

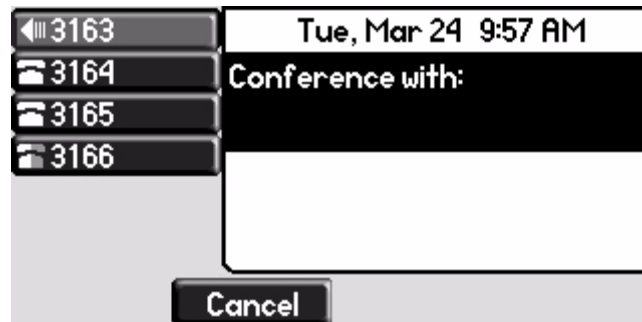

**Note**

If configured for single key-press conferences, all conference participants hear the dial tone and ringback when the conference host places a call to a new party.

3. Call the second party.
4. When the second party answers, press **Conference** or the **Confrnc** soft key again to join all parties in the conference.

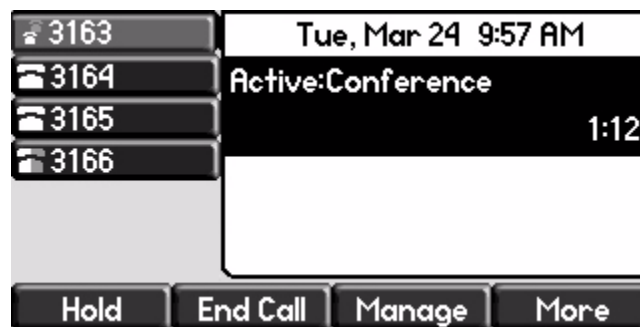

**Note**

If configured for single key-press conferences, you do not need to press the **Confrnc** soft key again.

5. Press **Conference** or the **Confrnc** soft key to add another party to the conference.

The first and second party are put on hold.

6. Call the third party.
7. After the third party answers, press **Conference** or the press the **More** soft key followed by the **Confmnc** soft key to join all parties in the conference.

A conference similar to this one will now exist.

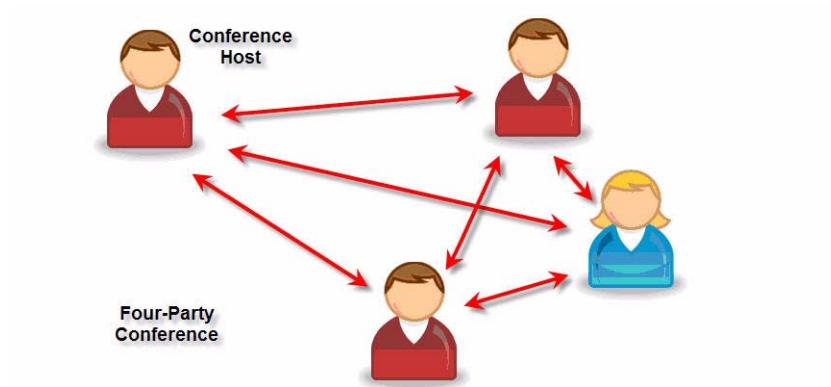

8. Repeat steps 5 to 7 until you have added all intended parties.

## Managing Conference Calls

You are currently in a conference call. A screen like the one below is shown on your phone.

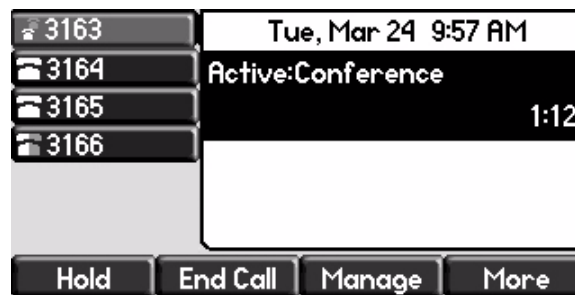

**To manage a conference call:**

1. Press the **Manage** soft key.

The Manage Conference page appears.



Press the **More** soft key to see the **Remove**, **Info**, and **Exit** soft keys.

2. Do one of the following:
  - To add a new party, press the **Add** soft key.  
Call another party as you would using **Conference** or the **Confnc** soft key (outside the conference management feature). The other parties are put on hold.  
After the new party answers, press **Conference** again to join all parties in the conference.

**Note**

The **Add** soft key appears only if you can add more parties to the conference call. Your system administrator determines the maximum number of conference participants. The default number is three. For more information, contact your system administrator

- To mute a party, select the party, then press the **Far Mute** soft key.



The muted party can hear all parties, but no party can hear the muted party.

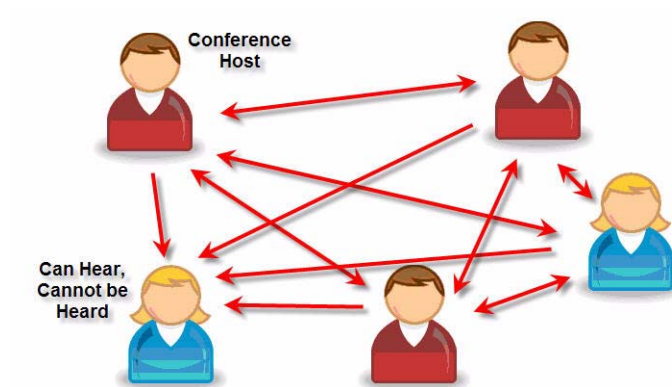

If you press  instead of the **Far Mute** soft key, all other parties can hear each other, but they cannot hear you.

Press the **UnMute** soft key to un-mute the party.

- To place a party on hold, select the party, and then press the **Hold** soft key.

The held party cannot hear any parties and no party can hear the held party.

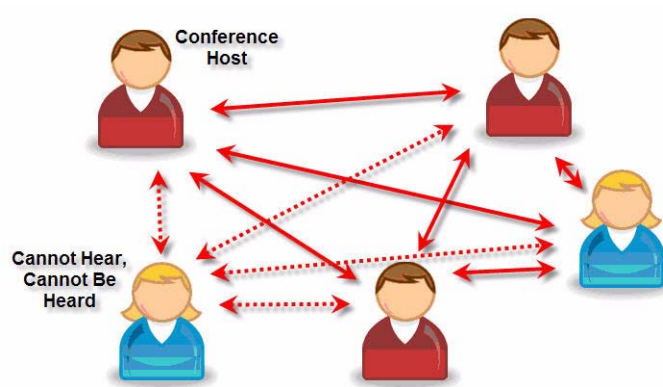

Press the **Resume** soft key to return the party to the conference.

If the held party presses  on their phone, the party will remain on hold within the conference even if you press the **Resume** soft key.

- To remove a party from the conference, press the **Remove** soft key.  
The party is removed from the conference. To return the party to the conference, press the **Add** soft key (refer to the first optional step above).

## Adding Parties to Conference Calls

**To add a party to a conference call using the Join soft key:**

You are currently hosting a conference call between a number of parties.

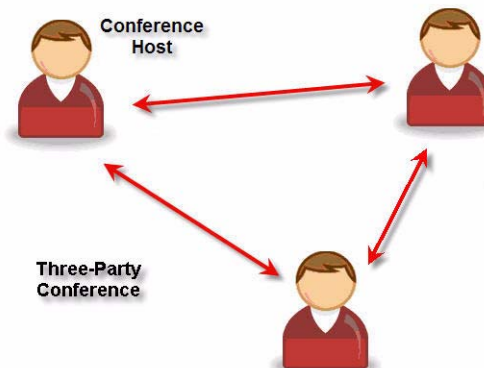



**To add a party to a conference call using the Join soft key:**

1. From the Manage Conference page, press  or the **Hold** soft key.

The other parties in the conference call are placed on hold.

**Note**

If configured for local conference hold, the other parties in the conference call can continue to speak with each other while you place the new call.

2. Press the **New Call** soft key.
3. Place a call to a new party.
4. After the new party answers, press the **Join** soft key.  
All parties in the conference call can now hear each other.

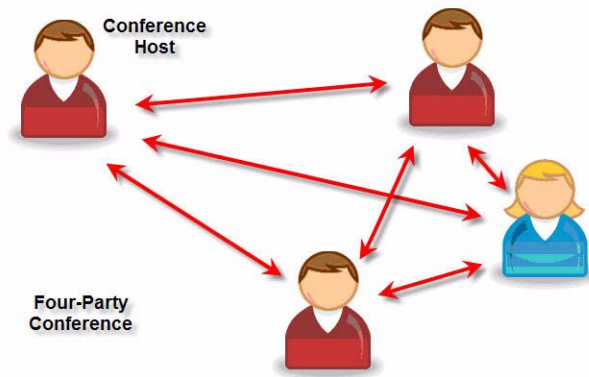
**Joining Conferences****To join two conferences:**

Previously you set up two separate conference calls between a number of parties. Only one conference can be active at a time.

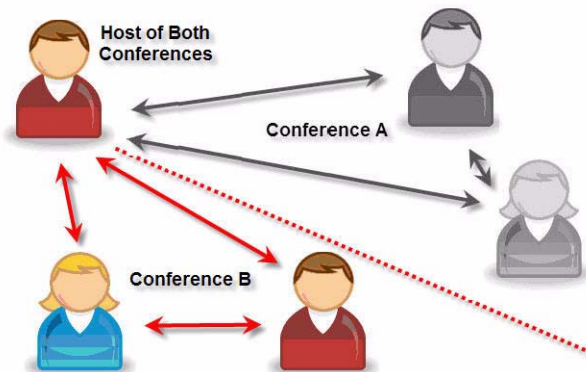

>> From the idle screen, press the **Join** soft key.

Both conferences are joined into a single five-way conference.

## Splitting Conference Calls

**To split a conference call:**

>> From the Active Conference page, press the **More** soft key, and then the **Split** soft key to split the conference.

All calls are split into individual calls and put on hold.

## Ending Conference Calls

**To end a conference call:**

>> From the Active Conference page, press the **End Call** soft key or hang up.

The other parties may or may not continue to be connected. The behavior after the conference host hangs up is configurable by your system administrator.

## Transferring Calls

A call can be transferred in one of three ways:

- Consultative transfer – The party to whom you want to transfer the call answers their phone before you transfer the call or hang up. You can consult with them before completing the transfer.
  - Refer to [Performing a Consultative Transfer](#) on page 3-17.
- Blind transfer – The call is automatically transferred after you dial the number of the party to whom you want to transfer the call.
  - Refer to [Performing a Blind Transfer](#) on page 3-18.
- Attended transfer – The parties are automatically connected to each other after you exit the conference.
  - Set up a conference call and then end your participation. For more information, refer to [Hosting Conference Calls](#) on page 3-9.

**Note**

Your system may be configured to end the conference when the host exits. Check with your system administrator.

## Performing a Consultative Transfer

### To transfer a call:

1. During a call, press the  or the **Trnsfer** soft key.  
The active call is placed on hold.

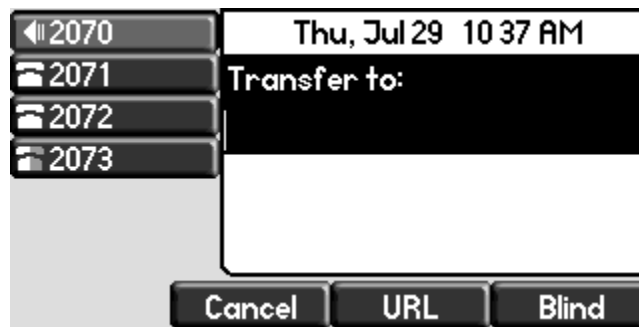

2. Place a call to the desired recipient of the call. Refer to [Placing Calls](#) on page 2-2 for calling methods.
3. As soon as you hear the ring-back sound or after the party answers (and you speak to the party), press  or the **Trnsfer** soft key.



You can talk privately to the party to which you are transferring the call before the transfer is completed.

If you are using a handset, the transfer can be completed by putting the handset on the cradle.

You can cancel the transfer before the call connects by pressing the **Cancel** soft key.

## Performing a Blind Transfer

### To perform a blind transfer:

1. During a call, press  or the **Transfer** soft key.
2. Press the **Blind** soft key.



3. Place a call to the desired recipient of the call. Refer to [Placing Calls](#) on page 2-2 for calling methods.

At this point, the call is connected to the number to which you are transferring them.

## Forwarding Calls

There are two ways to forward incoming calls to another party:

- **Static Forwarding:** Incoming calls are forwarded in special cases (before ringing, if there is no answer, or if the line is busy).
- **Dynamic Forwarding:** You can forward a call to someone else as it is ringing on your phone.

All incoming calls can be forwarded to another party while Do Not Disturb is enabled on your phone. For more information, contact your system administrator.

### Note

Call Forwarding is not available on shared lines.

This feature is local to the phone, and may be overridden by call server settings. For more information, contact your system administrator.

## Static Forwarding

### To forward all incoming calls to another party:

1. From the idle screen, press the **Forward** soft key.

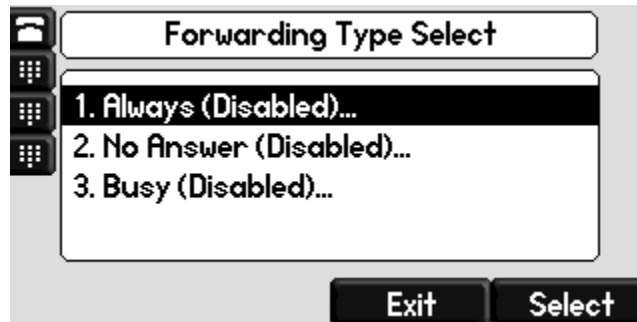

2. If multiple lines are configured on your phone, select the line to forward from the list using  $\triangle$  and  $\nabla$ .
3. Scroll to select the forwarding type you want to change, and then press the **Select** soft key. The options are:
  - **Always** – To forward all incoming calls
  - **No Answer** – To forward unanswered incoming calls
  - **Busy** – To forward calls that arrive when you are already in a call
4. Depending on your selection:
  - a If you selected **Always**, enter a number to forward all future incoming calls to.

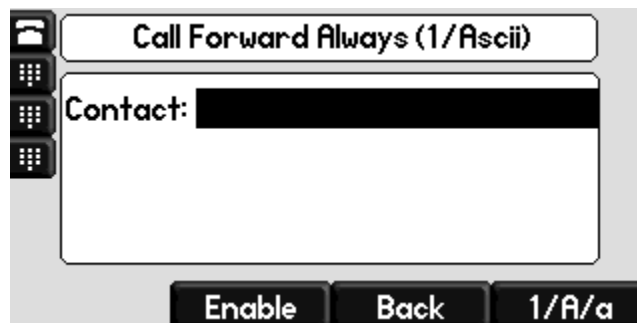

- b If you selected **No Answer**, enter a number to forward all unanswered incoming calls to and how many rings to wait before forwarding (one ring is approximately six seconds). A value of 2 is recommended.

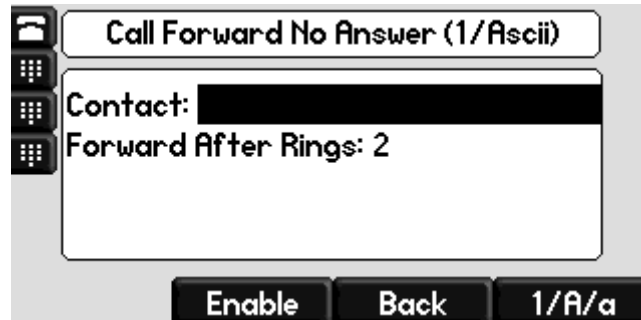

- c If you selected **Busy**, enter a number to forward all future incoming calls to when you are already in another call.





**Note**

You can also enter the SIP URL or IP address. For more information on using a SIP URL or IP address, refer to [Placing Calls](#) on page 2-2

5. Select the **Enable** soft key to confirm call forwarding.

A moving arrow appears on the line label to confirm call forwarding is enabled.

**To disable call forwarding:**

1. From the idle screen, press the **Forward** soft key.
2. If multiple lines are configured on your phone, select the line to forward from the list using  and .
3. Scroll to highlight the forwarding type you want to disable and then press the **Select** soft key.
4. Press the **Disable** soft key.

The idle screen returns, the regular icon appears as the line indicator.

## Dynamic Forwarding

### To forward an incoming call to another party:

1. When the phone rings, press the **Forward** soft key.
2. Enter a number to forward the incoming call to.
3. Press the **Enable** soft key.

The incoming call is forwarded to the other party. If call forwarding is disabled, all future calls will not be forwarded and forwarding will remain disabled.

## Enabling Do Not Disturb

To prevent the phone ringing (from incoming calls), you can select Do Not Disturb.

### Note

This feature is local to the phone, and may be overridden by call server settings. For more information, contact your system administrator.

### To enable Do Not Disturb:

>> Press  .

A flashing icon and text on the graphic display indicate that Do Not Disturb is enabled.

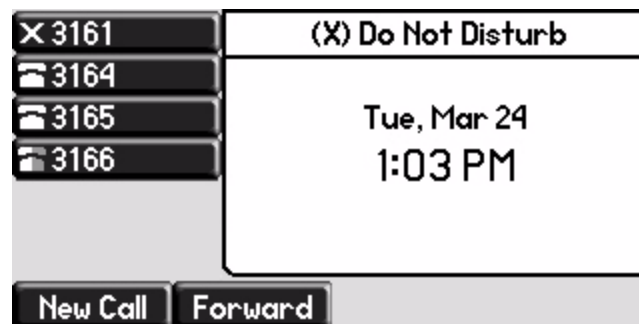



Calls received while Do Not Disturb is enabled are logged in the Missed Calls list unless configured to be forwarded to another party by your system administrator.

### To disable Do Not Disturb:

>> Press  again.

### Multiple Lines and Do Not Disturb

If multiple lines are configured on your phone, Do Not Disturb can be set on a line-by-line basis from the menu using  and  if enabled by your system administrator. When Do Not Disturb is enabled for a particular line, a flashing “X” displays beside the line indicator.

## Assigning Speed Dial Keys

You can associate contacts with Line Keys for single touch dialing of frequently used numbers. Speed Dial entries are consecutively placed next to assigned Line Keys on the phone. When a new entry is added to the Contact Directory, it is automatically assigned the next available speed dial index and the next available line key.

In the figure below, the phone has one line key, and speed dial keys for Byron, Lauren, and Andrew. To dial Byron, Lauren, or Andrew, press the associated line key.

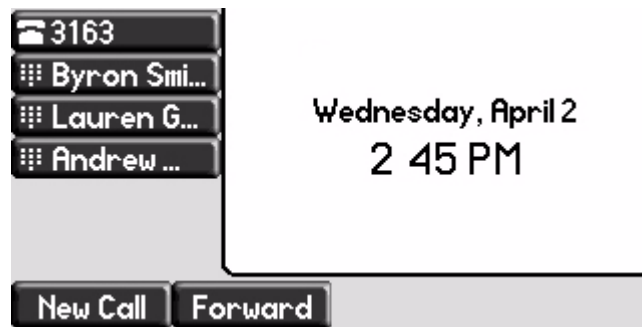

#### Note

To quickly access a list of speed dial index numbers, press the **Up Arrow** key from the idle screen. To speed dial a contact, press the **Up Arrow** key followed by the contact's speed dial index. For example, if Joan's speed dial index is 55, pressing the **Up Arrow** key followed by **55** will place a call to Joan.

### Assigning New Speed Dial Keys

#### To add or edit a speed dial index for an existing contact:

1. Press .



2. Select **Contact Directory**.
3. Scroll to highlight the contact.  
You can also use the \* key to page up and the # key to page down.
4. Press the **Edit** soft key.



5. Do one of the following:
  - Enter the next available speed dial index.
  - Delete the existing speed dial index by using , and then enter a new speed dial index.

A valid speed dial index is any unused number from 1 to 9999.
6. Press the **Save** soft key to accept your changes.
7. Press  to return to the idle screen.

#### To assign a new speed dial key:

1. Press and hold an unassigned .  
A new empty entry in the contact directory is automatically opened allowing contact information to be added.
2. (Optional.) Enter contact information.  
Use the **1/A/a** soft key to select between numeric and upper/lower case alphanumeric modes.  
Use the **Encoding** soft key to access special characters in other languages.
3. Enter a contact number.  
The number must be unique (not already in the directory).
4. Change the Speed Dial Index field.  
The index can be any value between the next available index value and the maximum (value of 9999).



Polycom recommends that you assign speed dial index values consecutively. For example, if you assign the third Line Key to the speed dial index value "2", assign the fourth Line Key to the speed dial index value "3".

5. Press the **Save** soft key to accept your changes.
6. Press  to return to the idle screen.

## Using Voice Mail

### Note

Voice mail is an optional feature configured on the call server and may not be supported on your particular system. For more information, contact your system administrator.

Screen options may vary with your application. Voice mail may be accessible with a single key press. Contact your system administrator about this option.

You can access voice mail messages from your phone (if enabled). Your voice mail is saved in a centralized location.

Your phone indicates the presence of new voice mail messages by a flashing Message Waiting Indicator LED on the front of the phone and a visual notification on the screen. If your phone has multiple lines, an individual line indicator icon indicates voice mail messages on that line.

A stutter dial tone in place of normal dial tone indicates that one or more voice messages are waiting at the message center.

### To listen to voice messages:

1. Press  .

If multiple lines are configured on your phone, select the line to retrieve messages from.

2. Follow voice or visual prompts on the screen to retrieve your messages.

## Locking and Unlocking the Phone

### Note

Locking your phone is a feature that your system may not support. For more information, see your system administrator.

Your system administrator can set up your phone to automatically lock if it has remained idle for a certain period of time.

Lock your phone to:

- Prevent unauthorized outgoing calls.
- Allow only authorized people to answer calls.
- Prevent people from viewing or modifying phone displays or information (for example, menus, directory lists, call records, and speed dial keys).

When your phone is locked:

- You can only make an outgoing call to a number from a list of configurable authorized numbers.
- You have to enter a password to answer incoming calls.
- All keys and soft keys are disabled, except those that allow you to unlock the phone, make an authorized call, or redial a number.

You unlock the phone by entering your user password. If your phone restarts for any reason while it is locked, it will be locked when the phone starts up again (unless your phone is configured to start up unlocked).

When your phone is locked, the messages “This phone is locked” and “Authorized calls only” scroll on the status bar. Messages that were displayed before the phone was locked do not display.

## About Your User Password

You are assigned a user password so you can answer calls from your locked phone and unlock the phone.

### Changing Your User Password

By default, your user password is 123. Change your user password so it is unique to your phone.

#### To change your user password:

1. Press  > **Settings** > **Advanced**.
2. From the Password screen, enter your current user password and press the **Enter** soft key.

**Note**

Your user password will let you see certain items in the Advanced Settings menu. To see the full Advanced Settings menu, you need to enter the administrator password.

3. From the Advanced screen, select **Change User Password**.
4. From the Change User Password screen, enter your password information and press the **Enter** key.

## Locking and Unlocking Your Phone

You can choose how you want your phone to handle incoming calls when it is locked. You can configure your phone to either allow incoming calls, or activate Do Not Disturb when it locks.

### To Lock your Phone:

1. Press  > **Settings** > **Basic** > **Lock Phone**.
2. From the Lock Phone screen, select how you want incoming calls handled when your phone is locked.
  - **Allow ringing when locked (default)**- Your phone will ring if you have an incoming call. You can answer the call after entering your user password.
  - **DND when locked** - You will not receive indication of any incoming calls. Calls will go directly to voice mail (if enabled) and display in your Missed Calls list when you unlock the phone.

**Note**

Enabling **DND when locked** on shared lines disables ringing only. You will still see a visual notification of the call and have the option to answer it.

3. Press the **Lock** soft key.

Your phone is locked.

**Note**

Your phone may be set up so that you can quickly lock your phone by pressing the **Lock** soft key from the idle screen. If you do this, however, you cannot choose how to handle incoming calls. Your phone will use the default setting (Allow ringing when locked), or the last setting you selected.

### To unlock your phone:

1. From the idle screen, press the **Unlock** soft key.

2. From the Unlock the Phone screen, enter your user password, and then press the **Enter** soft key.

For information on your user password, including what to do if you forget it, see [About Your User Password](#) on page 3-25.

The phone unlocks.

## Calling and Answering from a Locked Phone

From a locked phone, anyone can dial the standard emergency number (for example, 911), and up to five authorized numbers that an administrator can set up. You cannot call any other numbers from a locked phone.

If you set up your phone so you can answer incoming calls when it is locked, you can answer calls by first entering your user password.

### To call an authorized number from a locked phone:

>> Do one of the following:

- Press the **New Call** soft key. From the Place an Authorized Call screen, select the number you want to call, and then press the **Dial** soft key.

The following screen shows an example of the Place an Authorized Call screen. Note that the three speed dial keys on the left are greyed out because they are all unauthorized numbers.



or

- Place a call to an authorized number by using the handset, headset or speakerphone. For information on using the handset, headset or speakerphone to place a call, see [Placing Calls](#) on page 3-2.

The call is placed.

### To answer a call on a locked phone:

1. While the phone rings, press the **Answer** key.
2. From the Answer the Call screen, enter your password, and then press the **Enter** soft key.

(If you press the **Cancel** soft key instead, the Answer the Call screen disappears and the incoming call window displays again).

(For information on your user password, including what to do if you forget it, see [About Your User Password](#) on page 3-25).

The call connects.

## Logging Into Phones

If your system administrator has set up the User Login feature, you can view your personal phone settings from any phone in the organization. This means you can access your contact directory and speed dials, as well as other phone settings, even as you temporarily change work areas.

If you change any settings while you're logged in to a phone, the settings are saved and displayed the next time you log in to a phone. When you log out, your personal phone settings no longer display.

You can log in to a phone by entering your user ID and password. Default passwords are preset at the factory to the numerals 123.

### Note

If a phone is in the logged out state and requires a user login, you may be able to use the phone to place emergency calls to standard emergency numbers (such as 911) and other pre-configured phone numbers. These numbers are configured by your administrator. For information on how to place authorized calls, see ["Placing Calls from Phones that are in the Logged Out State"](#) on page 40.

If the User Login feature is set up on your organization's phones, you'll need to know how to:

- Log in to a phone to access your personal phone settings.
- Log out of a phone after you finish using it.
- Place a call to an authorized number from a phone that is in the logged out state and requires a user login.
- Change your user password.

## Logging In and Out of a Phone

Depending if the User Login feature is enabled and required, you may or may not have to log in to the phone to use it. However, if you want to see your personal phone settings from the phone, you'll have to log in. If you don't log in, you'll see the phone's default phone profile.

While logged in, you'll have full access to your personal phone settings and your contact directory. After you log out of the phone, you'll no longer be able to view this information on the phone.

After you use a phone, be certain to log out of the phone to prevent access to your personal settings.

### To log in to a phone:

- 1 If the User Login screen is in view, go to step 2. If the User Login screen isn't in view, do one of the following:
  - Press the **Log in** soft key.
  - Press the **Menu** key, then select **Features > User Login > Log in**.

The User Login screen displays, as shown next.



- 2 Enter your user ID and user password, then press the **Log in** soft key.

If your login credentials are accepted, the phone updates to display your personal phone profile, and the home screen displays, as shown next.

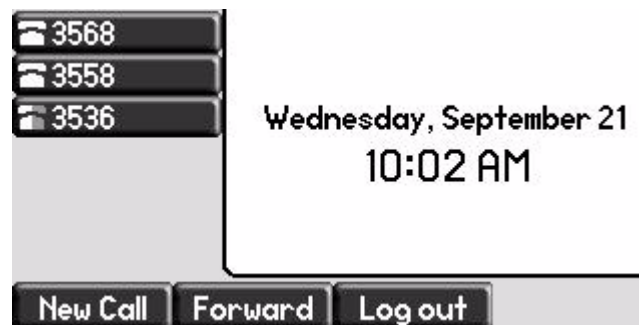

If you don't know what your user ID and password are, ask your system administrator. Default passwords are preset at the factory to the numerals 123. However, your system administrator may have changed this for security reasons.

If your credentials are not accepted, the message 'User login failed' is displayed, and the User Login screen displays again. If you need to confirm your credentials, ask your system administrator.

### To log out of a phone:

- 1 From the home screen, do one of the following:

- Press the **Log out** soft key.
- Press the **Menu** key, then select **Features > User Login > Log out**.

The Logout screen displays with a confirmation message, as shown next.

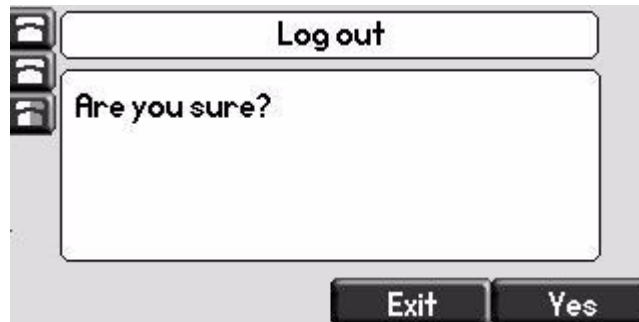

- 2 Press the **Yes** soft key.

Your personal profile is no longer accessible, and the phone displays either the User Login screen for the next user login, or the default phone profile for anonymous users.

## Placing Calls from Phones that are in the Logged Out State

If a phone doesn't require a user login, you can use the phone to place calls to any number, even though the phone may be in the logged out state.

If a phone requires a user login, you may be able to place calls to authorized numbers when the phone is in the logged out state. If your system administrator has set up emergency numbers on the phone, you can place calls to the standard emergency number (for example, 911) and up to five other authorized numbers. You won't be able to call any other numbers until you log in to the phone.

### To place a call to an authorized number from a phone in the logged out state:

- 1 Press the **New Call** soft key.

The Place an Authorized Call screen displays, as shown next.





- 2 Select the number you want to call, then press the **Select** soft key or the **Dial** key.

The call is placed.

## Changing Your User Password

You can change your password from any phone that you're logged in to.

### Note

By default, user passwords are factory preset to the numerals 123. Your administrator can change this default password if needed. Polycom recommends that you change your password when you first log in to a phone. Your user ID is managed only by your administrator, meaning you cannot change it yourself.

### To change your user password:

- 1 Log in to any phone on your network.
- 2 From the home screen, press the **Menu** key, then select **Features > User Login > Change User Login Password**.

The Change User Login Password screen displays, as shown next.

- 3 Enter your old password and your new password twice, and then press the **Enter** soft key.

The 'User password changed' message displays. Your password is changed.

The next time you log in to a phone, you'll need to enter this password.



---

# Using the Advanced Features of Your Phone

This chapter provides operating instructions for the advanced features of the Polycom® SoundPoint IP 670 phone. The topics include:

- [Using Multiple Call Appearances](#)
- [Using Buddy Lists](#)
- [Recording a Call](#)
- [Playing Back a Recorded Call](#)
- [Broadcasting Messages Using Push-to-Talk and Group Paging](#)
- [Accessing Features with Your Login Credentials](#)
- [Updating Your Phone's Configuration](#)
- [Restarting Your Phone](#)

To customize your phone, refer to [Customizing Your Phone](#) on page 2-1. To read about the phone's basic features, refer to [Using the Basic Features of Your Phone](#) on page 3-1.

If you require additional information or assistance with your new phone, contact your system administrator.

## Using Multiple Call Appearances

When multiple call appearances is set up, you can see information for more than one call at one time. For example, if you have an active call, you can see information for an incoming call as well.

For example, the following figure shows an active call with Lauren Gates on line 3161.

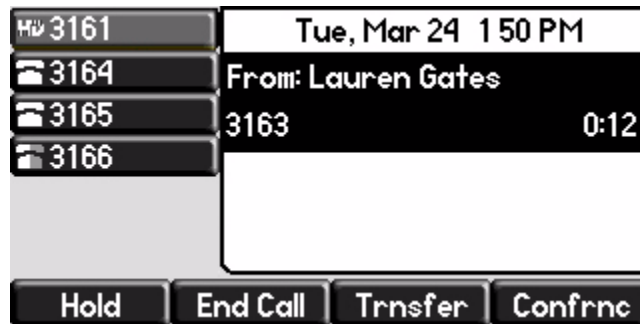

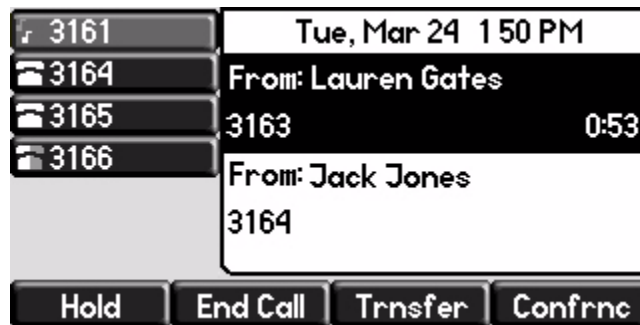

The following figure shows an incoming call from Jack Jones on the same line.



**To answer an incoming call when configured for multiple call appearances:**

>> Do one of the following:

- Press  or the **Hold** soft key to place the original call on hold.
- Press  to access the new call.

Answer the incoming call.

This original call is placed on hold and the incoming call becomes the active call.



Your phone can display two call appearances at one time. If more than two calls are taking place on the same line, a counter displays on the display. Use the down arrow to access additional calls, or call appearances.

To place an additional call on the same line, place the active call on hold, and then press the **New Call** soft key.

## Using Buddy Lists

A buddy list is a list of users/devices whose status, or presence, you can monitor. Users update their presence setting (for example, "Be right back", "Busy", or "Out to lunch"), and you can view their status in real-time from your phone.

Your phone can "watch" the status of up to eight other phones or 48 buddies. These other phones form your "buddy list". Your phone displays the status of your buddies in real time. Your phone can be "watched" by up to eight other phones.

## Updating Your Presence Settings

**To view and change your presence settings:**

1. Do one of the following:

- Press  .  
Select **Features > Presence > My Status**.
- Press the **MyStat** soft key.

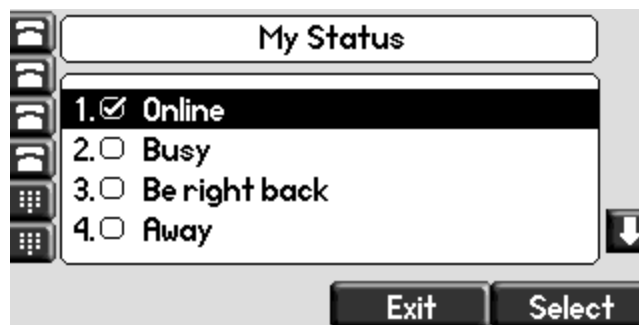

2. Scroll through the list, and then press the **Select** soft key to select your new status.



The phones watching your status will now display your new status.

Presence information will also be sent to watching phones when you go off-hook or enable Do Not Disturb.



## Managing Buddies

Manage your buddies by selecting the contacts whose presence you want to monitor. These contacts form your buddy status list. You add contacts to your buddy status list from your contact directory.

### To add or delete a contact from your buddy list:

1. Press  .
2. Select **Contact Directory**.
3. Scroll to highlight the contact.  
You can also use the \* key to page up and the # key to page down.
4. Press the **Edit** soft key.
5. Scroll to the Watch Buddy field.
6. Toggle to select Enabled.  
If Watch Buddy is enabled, the contact is added to your buddy list.  
If disabled (default), the contact is removed from your buddy list.
7. Press the **Save** soft key to accept your changes.
8. Press  to return to the idle screen.

### To block or unblock a contact from your buddy list:

1. Press  .
2. Select **Contact Directory**.
3. Scroll to highlight the contact.  
You can also use the \* key to page up and the # key to page down.
4. Press the **Edit** soft key.
5. Scroll down to the Block Buddy field.
6. Toggle to select Enabled.  
If Block Buddy is enabled, the contact cannot watch your phone.  
If disabled (default), the contact can watch your phone.
7. Press the **Save** soft key to accept your changes.
8. Press  to return to the idle screen.

## Recording a Call

### Note

Call Recording is an optional feature and may not be supported on your particular system. For more information, contact your system administrator.

If the Call Recording and Playback feature is available and you plug a removable USB flash drive into the USB port on your SoundPoint IP 670 (shown below), you can record active calls on your phone.

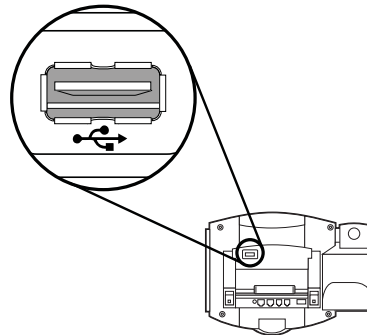

Recordings are stored as **.wav** files on the USB flash drive. You can record up to 4 hours in one file. The approximate time remaining for recording (the free space on the USB flash drive) is shown on the graphic display.



The **Record** soft key controls recording and is available:

- When there are one or more calls connected to your phone (you may need to press the **More** soft key to see it)
- During an active call
- When calls are on hold
- During a consultative transfer or conference call

The **Record** soft key is not available:

- When there are no connected calls on your phone
- When you place a new call (to transfer or to conference)

- When the phone prompts you to answer an incoming call

If you put an active call on hold, recording pauses. Recording continues if the called party puts you on hold. Recording stops if all active calls end, no matter who ends the calls.

If you press  while recording, only the called parties are recorded.

Tones and indications (for example, dialing of digits or ringing from another party's phone) that occur before a call connects are not recorded. Local tones and indications (for example, DTMF tones when dialing) are not recorded. However, tones from another party's phone may be recorded.

You can start, pause, resume, and stop recording through the use of soft keys. All active calls that occur on your phone between the time you press the **Start** soft key and the **Stop** soft key are recorded, alternating in the same **.wav** file.

For example, you place a call to party A and, after they answer, you start recording on October 4, 2007 at 11:22am. While speaking with party A, you get an incoming call. You put party A on hold and speak with party B. When you finish speaking with party B, you return to speaking with party A. While speaking with party A again, you get another incoming call. You put party A on hold and speak with party C. When you finish speaking with party C, you return to speaking with party A. You end your call with party A and recording stops. Your conversations with parties A, B, and C are all recorded in the same **.wav** file as follows:

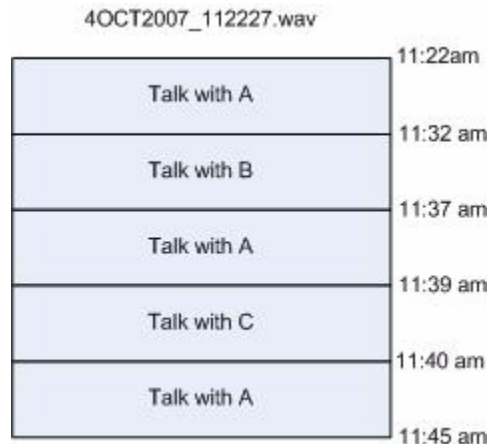

To properly remove the USB flash drive, end recording first, and then remove the device from the USB port. If you remove the USB device while recording, the file will be incomplete and will not playback later. There is also a small probability that the USB flash drive may be damaged.

When you remove a USB flash drive, wait until the "Storage media removed" message disappears before plugging in another one.



For a list of supported USB devices, refer to Technical Bulletin 38084 *Supported USB Devices for SoundPoint IP 650 and 670 and Polycom VVX 1500 phones* available from

[http://www.polycom.com/support/voice/soundpoint\\_ip/VoIP\\_Technical\\_Bulletins\\_pub.html](http://www.polycom.com/support/voice/soundpoint_ip/VoIP_Technical_Bulletins_pub.html)

#### Note

You may be required by federal, state, and/or local laws to notify some or all called parties when you are recording (either one-party or all-party consent). Specific information about US state requirements can be found at <http://www.rcfp.org/taping/>. Telephone call recording regulations in other countries vary widely. Polycom recommends checking with the local government's telecommunications authority and government legal agencies.

Other information that may be useful can be found at:

- <http://www.fcc.gov/cgb/consumerfacts/recordcalls.html>
- <http://www.privacyrights.org/fs/fs9-wrtp.htm>

This section includes information on:

- [Recording Calls](#)
- [Recording Conferences](#)
- [Pausing and Resuming Recording](#)

To playback recorded calls, refer to [Playing Back a Recorded Call](#) on page 3-15.

## Recording Calls

### To record a call:

1. During a call, press the **More** soft key.



2. Press the **Record** soft key.



3. To start recording, press the **Start** soft key.



"\*R\*" appears on the graphic display while the phone records.

If you press the **Back** soft key, you can access the top-level soft keys (for example, **Hold**, **EndCall**, **Trnsfer**, and **Confrnc**). You must navigate back (using the **More** and **Record** soft keys) to again access the **Stop** and **Pause** soft keys.

4. Stop recording in one of the following ways:
  - Press the **Stop** soft key.
  - Hang-up or end the active call.

## Recording Conferences

You can record conference calls in the same way as other calls with the following exceptions:

- All parties in a conference call are recorded. If one of the conference parties presses , they are not recorded.
- When all parties in a conference call are put on hold together, recording is paused. You can place or answer other calls, which will be recorded in the same file. When the conference call is resumed, recording of the conference resumes.

## Pausing and Resuming Recording

You can pause recording by pressing the **Pause** soft key. When you press the **Resume** soft key, recording continues with the same **.wav** file.

### To pause a recording:

>> Press the **Pause** soft key.

"\*P\*" appears when you pause recording.



### To resume a recording:

>> Press the **Resume** soft key.

"\*R\*" appears when you restart recording.



## Playing Back a Recorded Call





### Note

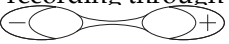

Call Playback is an optional feature and may not be supported on your particular system. For more information, contact your system administrator.

If the Call Recording and Playback feature is available, and a removable USB flash drive is plugged into the USB port of your SoundPoint IP 670, you can play back calls that you recorded on your phone.

You can browse the recorded files, stored as **.wav** files on the USB flash drive. You can also open, rename, and delete the recorded files.

You can play, pause, resume, and stop recording through the use of soft keys. Playback occurs in real time. Pressing  adjusts the volume of the receiver audio during playback.

Playback stops if you press the **Exit** soft key, , , , or .

If the handset is off-hook when you press the **Play** soft key, you will hear audio through the handset. If the handset is on-hook when you press the **Play** soft key, you will hear audio through the speaker. If the handset is on-hook, pressing  is the same as pressing the **Play** soft key, and pressing  again is the same as pressing the **Exit** soft key. If you lift the handset while you are listening through the speaker, you will now hear the audio through the handset.

You cannot start playback while a call is in progress or if you have placed a call. The message "Active call. Action aborted." appears in either case. If all

calls are on hold, you can start playback. If you press  on the selected call or the particular line key for the held call, playback stops and the call resumes.

You cannot place a call while playback is in progress using the dial pad. However, you can place a call using a speed dial key or line key. You can answer calls while playback is in progress (refer to [Answering a Call While Playing Back Recorded Calls](#) on page 4-13).

You can also playback recorded files on other devices, such as a computer using an application capable of playing **.wav** files.

If an error occurs while playback is in progress, playback stops. If you remove the USB flash drive during recording, recording stops and the message "USB device removed unsafely. Playback cancelled." appears.



Polycom recommends that you do not remove the USB flash drive while playing back files. There is a small probability that the USB flash drive itself may be damaged by this action.

This section includes information on:

- [Browsing Recorded Calls](#)
- [Playing Back Recorded Calls](#)
- [Answering a Call While Playing Back Recorded Calls](#)

## Browsing Recorded Calls

To browse the recorded files:

1. Press .
2. Select **Features > Removable Storage Media > Browse Recordings...**

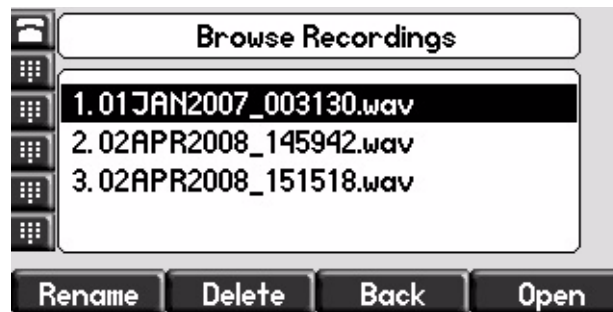

You can rename, delete, or open and open the selected **.wav** file by pressing the **Rename**, **Delete**, or **Open** soft keys.

3. Press  to return to the idle display.

## Playing Back Recorded Calls

### To playback a call:

1. Follow the steps above to open the desired recording.

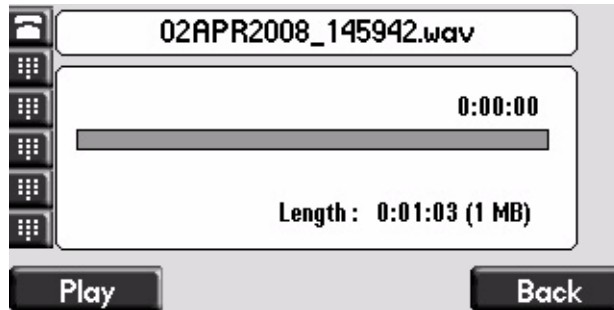

The filename you selected appears on the graphic display. The length of the file (in hours, minutes, and seconds) and the size of the file also appear.

2. Press the **Play** soft key.

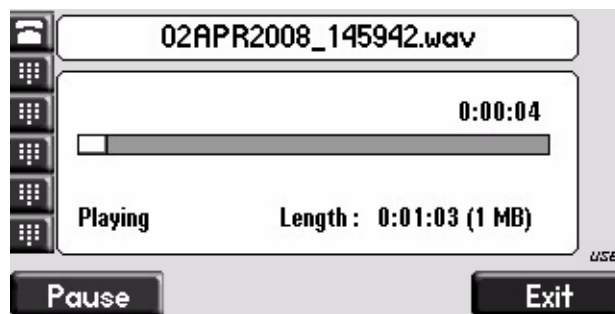

"Playing" appears on the graphic display. The position indicator (in hours, minutes, and seconds) above the progress bar changes as the file plays back in real time.

(Optional.) Press the **Pause** soft key to pause the file playback.

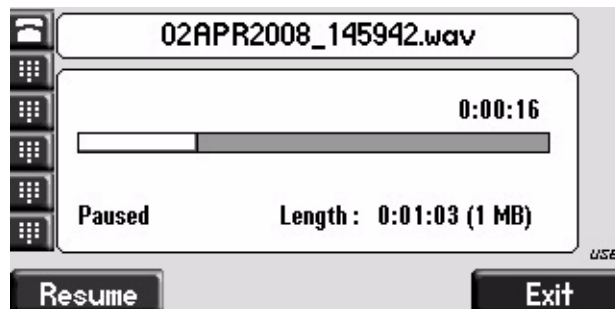

(Optional.) Press the **Resume** soft key to resume playback of the file.



3. Press the **Exit** soft key to stop playing back the file.  
To play the file from the beginning, press **Exit** and repeat the steps.
4. Press  to return to the idle display.

## Answering a Call While Playing Back Recorded Calls

If you are playing back a file and an incoming call arrives, playback pauses and the phone rings.

### To answer a call using the speakerphone:

>> Do one of the following:

- Press .
- If you were listening to the file through the phone's speaker, press the line key for the incoming call.
- If you were listening to the file through the phone's speaker, press , and then press the **Answer** soft key.

When the call ends, the idle display appears.

### To answer a call using the handset:

>> Do one of the following:

- Lift the handset.  
If you were listening to the file through the handset, hang up the handset, and then pick it up again.
- If you were listening to the file through the handset, press the line key for the incoming call.
- If you were listening to the file through the handset, press , and then press the **Answer** soft key.

When the call ends, the idle display appears.

### To answer a call using the headset:

>> Do one of the following:

- Press .
- If you were listening to the file through the headset, press the line key for the incoming call.

- If you were listening to the file through the headset, press



, and then press the **Answer** soft key.

**Note**

If you are using a digital headset with an answer button or an analog headset with a electronic switch, use those to answer the incoming call.

When the call ends, the idle display appears.

If you decide to reject the incoming call, press the **Resume** soft key, and playback will resume. For more information, refer to [Playing Back Recorded Calls](#) on page 4-12.

## Broadcasting Messages Using Push-to-Talk and Group Paging

The Group Paging and Push-to-Talk (PTT) features enable you to broadcast a message to as many people as have subscribed to a channel or have been placed in a group. Your system administrator can set up both features on your phone.

Group Paging mode enables you to broadcast a one-way announcement to people subscribed to a paging group. The people receiving the announcement can't respond to the message.

PTT mode enables you to broadcast a message to people subscribed to a channel. The people receiving the message can respond to the message by broadcasting a message over the same channel. In this way, PTT is a collaborative broadcast mode.

Your system administrator can define up to 25 Paging Groups (for Group Paging mode) or Channels (for PTT mode). Your system administrator may assign a label to each group or channel that easily identifies the phones in the group or channel (for example, All, HR Dept, Shipping Staff, or Executives). Each group or channel will have one of the following priorities:

- **Normal** (for Groups/Channels 1-23) – Broadcasts sent to Groups/Channels 1 to 23 are considered Normal broadcasts. When a phone receives more than one Normal broadcast, the first broadcast received is accepted, and all others are ignored (not played and not stored). By default, all phones receive broadcasts sent to Group/Channel 1.
- **Priority** (for Group/Channel 24) – Broadcasts sent to Group/Channel 24 are considered Priority broadcasts. All phones receive Priority broadcasts unless Do Not Disturb is enabled. If a phone receives a Priority broadcast while an Emergency broadcast is already playing, the Priority broadcast is



placed on hold. Phones play Priority broadcasts at the phone's current audio level.

- **Emergency** (for Group/Channel 25)— Broadcasts sent to Group/Channel 25 are considered Emergency broadcasts. All phones receive Emergency broadcasts (even if Do Not Disturb is enabled), and play them immediately. By default, phones play Emergency broadcasts at the highest audio level. The audio level will return to normal for subsequent non-Emergency broadcasts.

## Push-to-Talk Mode

Your phone may be enabled to operate in a broadcast mode called Push-to-Talk (PTT). In PTT mode, you broadcast messages on a specific channel. In order to send and receive PTT broadcasts on certain channels, you have to subscribe to those channels.

PTT broadcasts are collaborative: you can transmit messages and listen to replies.

### Sending and Receiving PTT Broadcasts

To send and receive PTT broadcasts, you need to subscribe to certain channels. By default, you're subscribed to Channels 1, 24 (the Priority channel), and 25 (the Emergency channel). This means that:

- You can send PTT broadcasts on Channels 1, 24, and 25.
- You'll receive PTT broadcasts sent on Channels 1, 24, and 25.

When you end a PTT broadcast, the channel remains open and enters a waiting period. This waiting period gives people who received the broadcast a chance to respond. If no one responds within the waiting period, the channel closes.

### Sending PTT Broadcasts

If you send a PTT broadcast without specifying a channel, it's automatically transmitted on the default channel. Channel 1 is the default channel that all broadcasts transmit on, if no channel is specified for a broadcast.

You can change your default channel to any channel you want (see [Updating the Default Channel](#) on page 4-19). If you change your default channel, you'll become subscribed to that channel automatically. To subscribe to a channel, see [Updating Channel Subscriptions](#) on page 4-20).

**To send a PTT broadcast:**

1. Press the **Talk** soft key to select a channel to broadcast on.



**Note**

To automatically send a PTT broadcast on the default channel, press and hold the **Talk** soft key, and then go to step 4.

2. From the PTT Channels List screen, select the channel to send the broadcast on (as shown next).

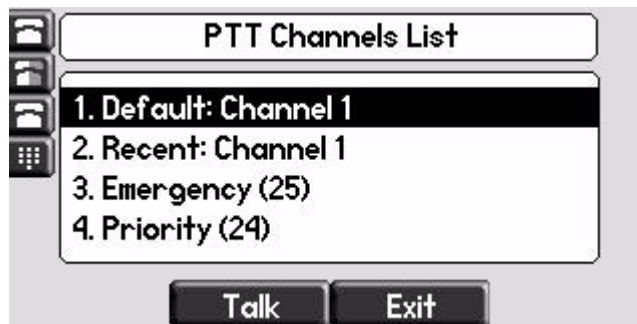

The list displays the default channel, the most recent channel you sent a broadcast on, and other channels you can broadcast on.

In the above example, the default channel is **1**, the recent channel is **1**, the Emergency channel is **25**, and the Priority channel is **24**.

3. To start the broadcast, press and hold the **Talk** soft key. (You need to press the **Talk** soft key throughout the entire broadcast.)

You'll hear a 'transmitting' beep, and then the phone displays the channel you are using ('To:Teachers (Channel 18)', as shown next).

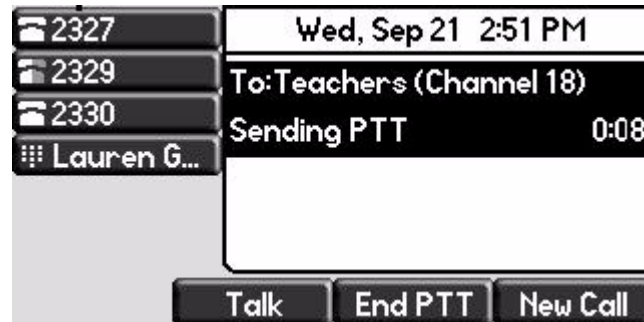

4. Start talking.

#### Note

If you release the **Talk** soft key while you're sending the broadcast, the broadcast temporarily stops and enters a 10 second 'Waiting' period. During this period, the channel remains open to give people a chance to reply. At any time during the waiting period, you can resume your broadcast by pressing and holding the **Talk** soft key. If no one broadcasts during the waiting period, the channel closes and the broadcast ends.

5. When you finish your broadcast, do one of the following:
  - Release the **Talk** soft key. The broadcast temporarily stops and enters a 10-second waiting period to allow others to reply, or you to resume the broadcast. If no one responds during a waiting period, the channel closes and the broadcast ends.
  - Press the **End PTT** soft key. The broadcast temporarily stops and enters a 10-second waiting period to allow others to reply. If there are no replies, the channel closes and the broadcast ends. After you tap the **End PTT** soft key, you can immediately initiate another broadcast on another channel, even if the previous broadcast is still in its waiting period.

#### Receiving PTT Broadcasts

To receive a broadcast sent on a particular channel, you need to be subscribed to that channel. To subscribe to a channel, see [Updating Channel Subscriptions](#) on page 4-20.

How you receive a PTT broadcast depends on the broadcast priority, whether you're in an active call, or if you're allowed to receive broadcasts during active calls.

You'll receive broadcasts on the channels you're subscribed to as well as Channel 24 (the Priority channel) and Channel 25 (the Emergency channel). If you've enabled **Do Not Disturb** on your phone, you'll only receive Emergency broadcasts. Non-emergency broadcasts won't display or play on your phone.

When a broadcast ends, your phone emits an 'end of transmission' beep and enters a 10 second waiting period. During this period, you can respond to the broadcast (see [Replying to PTT Broadcasts](#) on page 4-18).

### Receiving PTT Broadcasts When You're Not in an Active Call

If you receive a broadcast and you're not in an active call, the broadcast displays in the center of your screen and immediately plays, regardless of the broadcast priority.

### Receiving PTT Broadcasts During Active Calls

How you handle a broadcast when you're in an active call depends on the broadcast priority and if you're allowed to receive a broadcast when you're in an active call.

If the broadcast isn't a Priority or Emergency page:

- If your phone is allowed to receive broadcasts during active calls, the broadcast displays in the inactive call group as an active broadcast (as shown next) and immediately plays. You'll hear both the original call and the broadcast. To listen to only the broadcast, hold or end the call.
- If your phone isn't allowed to receive broadcasts during active calls, the broadcast displays as a *Pending* broadcast. To listen to the broadcast, hold or end the call, or select the broadcast, and press the **Accept** soft key.

If it's a Priority or Emergency broadcast, the broadcast displays in the inactive call group as an active broadcast and immediately plays. You'll hear both the original call and the broadcast. To listen to only the broadcast, hold or end the call.

### Replying to PTT Broadcasts

When a broadcast ends, you have a chance to respond to it before the channel closes.

When a broadcast ends, the broadcast enters a 10 second waiting period (as shown next). During this period, the channel remains open to receive or send additional broadcasts.

During a waiting period, you can press and hold the **Talk** soft key and talk to all the people listening on the channel. When you finish talking, release the **Talk** soft key. The broadcast will enter another waiting period until someone broadcasts again. If no activity occurs within the waiting period, the channel closes and no more broadcasts can take place.

### Ending PTT Broadcasts

You can end a PTT broadcast by releasing the **Talk** soft key, or by tapping the **End PTT** soft key. After you end a broadcast, the channel remains open so others can respond.

If you release the **Talk** soft key without pressing the **End PTT** soft key:

- You can resume the broadcast by pressing and holding the **Talk** soft key (if the broadcast is in a wait period).
- You can't initiate another broadcast on another channel until the waiting period ends.

If you press the **End PTT** soft key:

- You can't resume the broadcast by pressing and holding the **Talk** soft key.
- You can immediately initiate another broadcast on another channel.

### Adjusting the Volume of PTT Broadcasts

You can adjust the volume of PTT broadcasts while they play. During a broadcast, press either **Volume Up** or **Volume Down** to raise or lower the volume of the broadcast.

If you adjust the volume of a non-emergency broadcast, your phone retains the adjusted volume for all subsequent non-emergency broadcasts. However, even though you can adjust the volume of an Emergency broadcast, the adjusted volume won't be retained for subsequent Emergency broadcasts. All Emergency broadcasts play at the same volume, until you adjust it.

### Changing Where Broadcasts are Played

While you send a broadcast, you can pick up the handset or press the **Speakerphone** or the **Headset** key and continue speaking. You can also press the **Microphone Mute** key to mute your audio so that the people receiving your broadcast won't hear anything. This behavior is similar to a phone call.

When you listen to a broadcast, you can pick up the handset or press **Speakerphone** or the **Headset** key and continue listening to the broadcast.

### Updating the Default Channel

If you don't select a channel to broadcast on, your broadcast will automatically transmit on the default channel, Channel 1. If you want, you can change the default channel.

The default channel is automatically used when you initiate a broadcast by pressing and holding the **Talk** soft key.

### To update the default channel:

1. Press , then select **Settings > Basic > Preferences > Paging/PTT Configuration > PTT Push to Talk**.
2. Press the **Edit** soft key.
3. Enter the new default channel.
4. Press the **Ok** soft key.

### Updating Channel Subscriptions

You can subscribe to any channel that has been enabled by the system administrator and appears in your channels list. When you subscribe to a channel, you can send and receive PTT broadcasts on that channel.

### To subscribe to additional PTT channels:

1. Press , then select **Settings > Basic > Preferences > Paging/PTT Configuration > PTT Push to Talk**.
  2. From the PTT Channel Configuration screen, use the down arrow key to locate **Channels Subscriptions**, then press the **Select** soft key.
  3. From the Channels Subscriptions screen, use the down arrow key to select a channel to subscribe to, then press the **Edit** soft key.
  4. Use the left or right arrow keys to select **Yes**, then press the **Ok** soft key.
- By default, you're subscribed to Channels 1, 24, and 25.

### Allowing PTT Broadcasts to Play During Active Calls

The Accept While Busy option allows PTT broadcasts to come in as active calls (if enabled) as *Pending* (if disabled). A Pending page displays as if it were held.

If enabled, a PTT broadcast will interrupt telephone calls and you'll hear the audio of both the telephone call and the PTT broadcast. The party on the other end of the telephone call cannot hear the PTT broadcast unless that party has also enabled Accept While Busy.

If disabled, the incoming PTT broadcasts won't disrupt the phone call, and you won't hear the broadcast. To hear the PTT broadcast, select the broadcast and press the **Select** soft key (the phone call will automatically be held). Or, hold or end the phone call.

**To allow or disallow PTT broadcasts to play during an active call:**

1. Press  , then select **Settings > Basic > Preferences > Paging/PTT Configuration > PTT Push to Talk**.
2. From the PTT Channel Configuration screen, use the down arrow key to locate **Accept While Busy**, then press the **Select** soft key.
3. From the Accept While Busy screen, use the left or right arrow key to select **Enabled** or **Disabled**, then press the **Ok** soft key.

The default setting is **Disabled**. When enabled, your phone will accept and play broadcasts while you're in an active call. When disabled, your phone won't play broadcasts while you're in a call, but will hold them as *Pending* instead.

## Group Paging Mode

Your phone may be enabled to operate in a broadcast mode called Group Paging mode. In this mode, you broadcast one-way announcements to a specified group of phones, called a Paging Group. In Group Paging mode, users must subscribe to Paging Groups to send and receive pages.

### Sending and Receiving Pages

To send and receive pages, you need to subscribe to certain Paging Groups. By default, you're subscribed to Paging Groups 1, 24, and 25. This means that:

- You can send pages to Paging Groups 1, 24, and 25.
- You'll receive pages sent to Paging Groups 1, 24, and 25.

### Sending Pages

By default, when you send a group page, it's automatically sent to Paging Group 1. This is your default paging group.

You can change your default paging group to any group you want (see [Updating the Default Paging Group](#) on page 4-24). If you change your default paging group, you'll become subscribed to that paging group automatically. To subscribe to a paging group, see [Updating Paging Group Subscriptions](#) on page 4-25.

**To send a page:**

1. To send a page, press the **Paging** soft key.

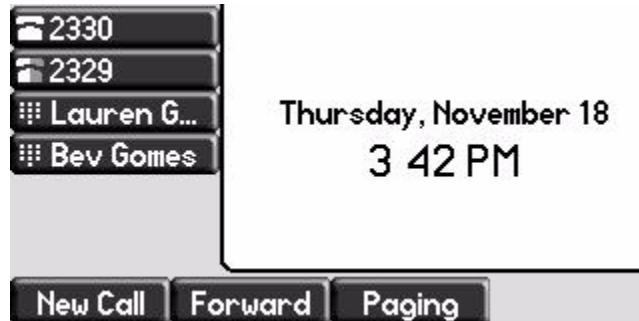

**Note**

To automatically send a page to the default paging group, press the **Paging** soft key.

2. From the Paging Groups List screen, select the paging group to send the page to (as shown next).

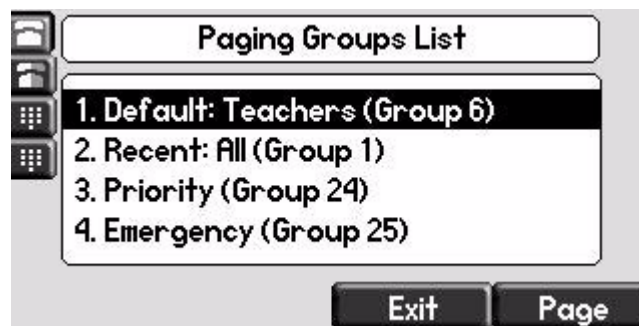

The list displays the default paging group, the most recent group you paged, and other paging group that you can page.

In the above example, the default paging group is **Group 6**, the recent paging group is **Group 1**, the Priority group is 24, and the Emergency group is 25.

3. To start the page, press the **Page** soft key.



Just before the page starts, you'll hear an alert tone, and then the page starts (as shown next).

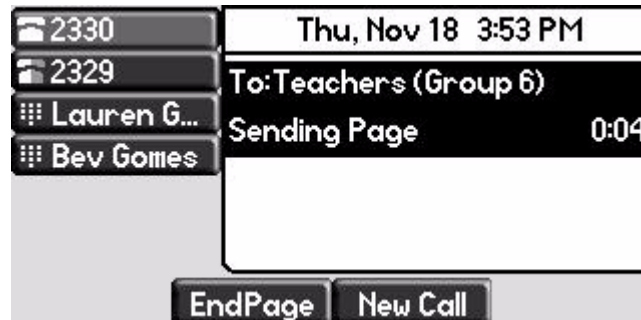

4. Start talking.
5. To end the page, press the **End Page** soft key.

### Receiving Pages

To receive a page sent to a particular paging group, you need to be subscribed to that group. To subscribe to a paging group, see [Updating Paging Group Subscriptions](#) on page 4-25.

How you receive a page depends on the priority of the page, whether you're in an active call, or if you're allowed to receive a page during an active call.

You'll receive pages on the paging groups you're subscribed to as well as Group 24 (Priority pages) and Group 25 (Emergency pages). If you enabled **Do Not Disturb**, you'll only receive Emergency pages. Non-emergency pages won't display or play on your phone.

### Receiving Pages When You're Not in an Active Call

If you receive a page and you're not in an active call, the page displays in the center of your screen and immediately plays, regardless of the paging priority.

While a page plays, you can:

- Hold the page.
- End the page. This ends the page at your phone only.
- Place a new call.

### Receiving Pages During Active Calls

How you handle a page when you're in an active call depends on the page priority and if you're allowed to receive a page when you're in an active call.

If the page isn't a Priority or Emergency page:

- If your phone is allowed to receive pages during active calls, the page displays in the inactive call group as an active page and immediately plays. You'll hear both the original call and the page. To hear only the page, hold or end the call.

- If your phone isn't allowed to receive pages during active calls, the page displays as a *Pending* page. To listen to the page, select the page and press the **Select** soft key. Or, hold or end the call.

You can listen to the page by resuming it. This will place the active call on hold.

If it's a Priority or Emergency page, the page displays in the inactive call group as an active page and immediately plays. You'll hear both the original call and the page. To hear just the page, hold or end the call.

### Adjusting the Volume of Pages

You can adjust the volume of pages while they play. During a page, press either **Volume Up** or **Volume Down** to raise or lower the page volume.

If you adjust the volume of a non-emergency page, your phone will use the adjusted volume for subsequent non-emergency pages. However, if you adjust the volume of an Emergency page, your phone won't use the adjusted volume for subsequent Emergency pages. All Emergency pages play at the same volume, until you adjust it.

### Changing Where Pages are Played

While you send a page, you can pick up the handset or press **Speakerphone** or the **Headset** key and continue speaking. You can also press the **Microphone Mute** key to mute your audio so that the people receiving your page won't hear anything. This behavior is similar to a phone call.

An incoming page plays from the speakerphone by default. If you lift the handset or press the **Headset** key, you'll hear a dial tone.

#### Note

Your system administrator can change your phone's configuration so that you can change where the page plays: the speakerphone, headset, or handset.

### Updating the Default Paging Group

If you don't select a group to send your pages to, your page will automatically go to the default paging group, Group 1. If you want, you can change the default paging group.

#### To update the default Paging Group:

1. Press , then select **Settings > Basic > Preferences > Paging/PTT Configuration > Group Paging**.
2. From the Group Paging Configuration screen, press the **Edit** soft key.  
The default paging group is 1.

3. Enter the number of the new default paging group, then press the **Ok** soft key.

### Updating Paging Group Subscriptions

By default, you're subscribed to Paging Groups 1, 24, and 25. This means that you can send pages to and receive pages sent to these groups. You can change which groups you are subscribed to. However, you can't disable your subscriptions to Paging Groups 24 and 25.

#### To update your Paging Group subscriptions:

1. Press , then select **Settings > Basic > Preferences > Paging/PTT Configuration > Group Paging**.
2. From the Group Paging Configuration screen, use the down arrow key to locate **Groups Subscriptions**, then press the **Select** soft key.
3. From the Group Subscription screen, use the down arrow key to select a group to subscribe to, then press the **Edit** soft key.

For example, you may want to enable subscriptions to Paging Group 6, so you'll be able to send pages to, and receive pages sent to, this group.

4. Use the left or right arrow keys to select **Yes**, then press the **Ok** soft key.

By default, you're subscribed to Channels 1, 24, and 25.

### Allowing Pages to Play During Active Calls

The Accept While Busy option allows pages to come in as active calls (if enabled) or *Pending* (if disabled). A *Pending* page displays as if it were held.

If enabled, a page will interrupt telephone calls and you'll be able to hear the audio of both the telephone call and the page. The party on the other end of the telephone call cannot hear the page unless that party has also enabled Accept While Busy.

If disabled, the incoming page won't disrupt the phone call, and you won't hear the page. To hear the page, select the page and press the **Select** soft key (the phone call will automatically be held). Or, hold or end the phone call.

#### To allow or disallow pages to play during an active call:

1. Press , then select **Settings > Basic > Preferences > Paging/PTT Configuration > Group Paging**.
2. From the Group Paging Configuration screen, use the down arrow key to locate **Accept While Busy**, then press the **Edit** soft key.

3. From the Accept While Busy screen, use the left or right arrow key to select **Enabled** or **Disabled**, then press the **Ok** soft key.

The default setting is **Disabled**. When enabled, your phone will accept and play pages while you're in an active call. When disabled, your phone won't play pages while you're in a call, but will hold them as *Pending* instead.

## Accessing Features with Your Login Credentials

Your system administrator may assign you login credentials—a domain, user name, and password.

If there is a problem with your login credentials, you won't be able to access the feature on your phone. When your phone has incorrect login credentials, the message 'Login Credentials failed.' displays on the screen. You must re-submit your login credentials.

### To re-submit or enter your login credentials:

1. Press  , then select **Settings > Basic > Login Credentials**.

The Login Credentials Domain screen displays.

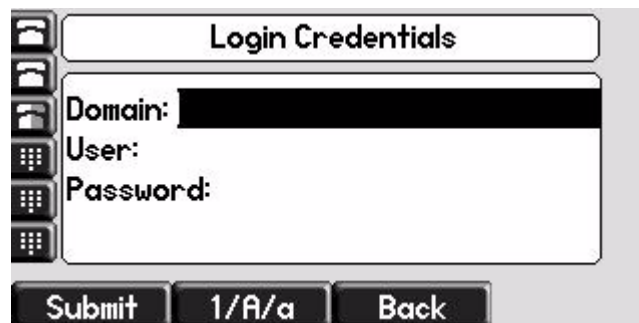

2. Enter the domain, user name, and password, then press the **Submit** soft key.

## Updating Your Phone's Configuration

Your phone can often accept a new configuration without requiring a restart.

### To update the phone's configuration:

1. Press  .

2. Select **Settings > Basic > Update Configuration**.  
“Are you sure?” appears on the screen.
3. If you still want to update the configuration, press the **Yes** soft key.  
The configuration is updated. On occasion, your phone may restart depending on which configuration parameters have changed.
4. If the phone did not restart, press  to return to the idle screen.

## Restarting Your Phone

In rare cases, your system administrator may ask you to restart your phone to assist in troubleshooting. It is sometimes possible to restore normal operation to a malfunctioning phone without restarting it. Your system administrator may want to perform diagnostics on the phone before restarting it, contact them before restarting the phone and losing current status information.

### Note

Do not restart your phone to upload a new configuration. Instead, refer to [Accessing Features with Your Login Credentials](#) on page 3-30.

### Note

Call lists are automatically cleared when you restart the phone.

### To restart the phone:

1. Press  .
2. Select **Settings > Basic > Restart Phone**.  
“Are you sure?” appears on the screen.
3. If you still want to restart your phone, press the **Yes** soft key.  
The restart process begins. The process ends when the idle screen appears.



---

# Using the SoundPoint IP Color Expansion Module

This chapter provides basic installation and operating instructions and information for obtaining the best performance with the Polycom® SoundPoint IP Color Expansion Module.

Each SoundPoint IP Color Expansion Module enhances the user interface of the SoundPoint IP 670 phone with a high-resolution graphic display and 14 Line Keys that can be automatically configured as a line, call appearance, speed dial, or busy lamp field. Up to three SoundPoint IP Color Expansion Modules can be connected to the SoundPoint IP 670 phone to provide a productivity-enhancing solution for users who manage and monitor multiple simultaneous telephone calls on a daily basis.

This topics include:

- [Connecting the SoundPoint IP Color Expansion Module](#)
- [Features of the SoundPoint IP Color Expansion Module](#)
- [Adjusting the Display Contrast](#)
- [Adjusting the Backlight Intensity](#)
- [Placing Calls](#)
- [Answering Calls](#)
- [Assigning Speed Dial Keys](#)
- [Using the Busy Lamp Field](#)

To customize your phone, refer to [Customizing Your Phone](#) on page 2-1. To read about the phone's basic features, refer to [Using the Basic Features of Your Phone](#) on page 3-1. To read about the phone's advanced features, refer to [Using the Advanced Features of Your Phone](#) on page 4-1.

If you require additional information or assistance with the Color Expansion Module, contact your system administrator.

## Connecting the SoundPoint IP Color Expansion Module

This section describes how to attach the SoundPoint IP Color Expansion Module to your SoundPoint IP 670 phone. You can attach up to three SoundPoint IP Color Expansion Modules.

### To connect a SoundPoint IP Color Expansion Module to your phone:

1. Remove the rubber plug from the SoundPoint IP 670 or the SoundPoint IP Color Expansion Module.

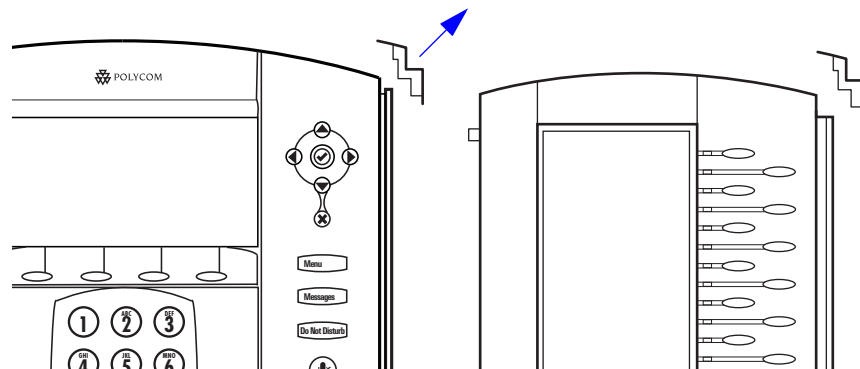

2. Align the SoundPoint IP Color Expansion Module at the top of the groove lines on the SoundPoint IP 670 phone and slide it downwards until it clicks into position.

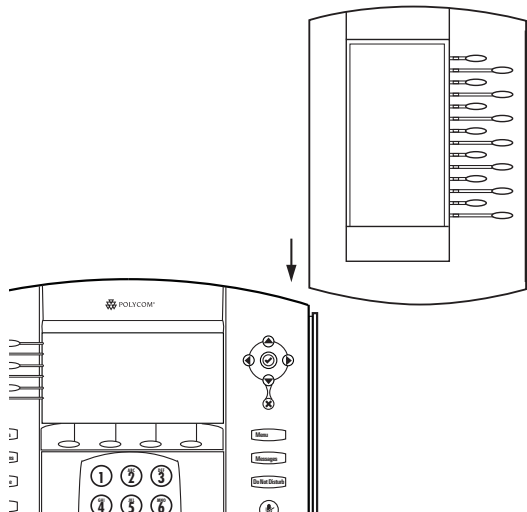

3. Connect the base stand by aligning the two protrusions on the stand to the holes on the back of the Color Expansion Module and snap it into place.

For each SoundPoint IP Color Expansion Module that you want to add, repeat steps 1 to 3.



## Features of the SoundPoint IP Color Expansion Module

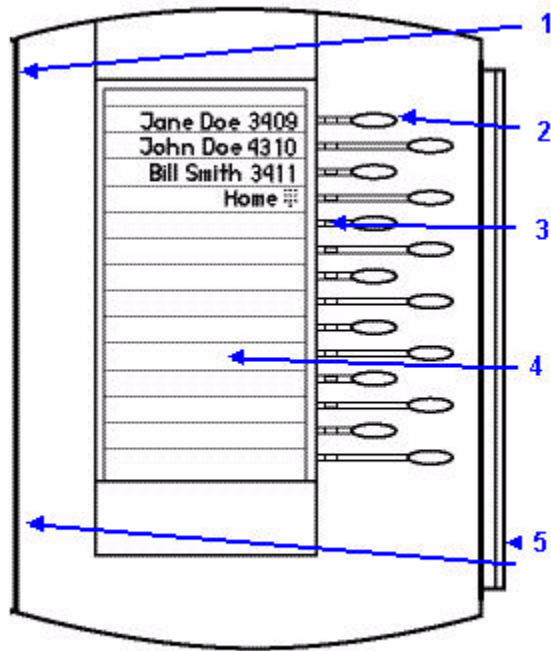

The features of the SoundPoint IP Color Expansion Module are:

	Item	Description
1	Power Contact	Not visible when you connect the SoundPoint IP Color Expansion Module to the phone. Power automatically transfers from the host phone to the SoundPoint IP Color Expansion Module(s) upon connection. You can plug in and unplug the units at any time
2	Line/Speed Dial Keys	Use these keys to activate up to 47 lines or speed dials that can be assigned to your phone.

	Item	Description
3	Line Indicators	Individual multi-color LEDs display the dynamic call state and remote user status (busy lamp field [BLF] and presence). The mapping is: Solid green—An active call is in progress. Fast flashing green—There is an incoming (ringing) call. Flashing green—Another party has put you on hold. Flashing red—The call is on hold. Solid red—The line is busy remotely (shared lines).
4	Graphic Display	Shows information about lines or speed dials.
5	Infrared Lens	Facilitates communications to the host phone and other Expansion Modules.

## Adjusting the Display Contrast

To adjust the display contrast on a SoundPoint IP Color Expansion Module, refer to [Changing the Display Contrast](#) on page 2-2.

## Adjusting the Backlight Intensity

To adjust the backlight intensity on a SoundPoint IP Color Expansion Module, refer to [Changing the Backlight Intensity](#) on page 2-3.

## Placing Calls

When you connect a SoundPoint IP Color Expansion Module to your phone, you can place a call using one of the Line Keys.

### To place a call using a SoundPoint IP Color Expansion Module Line Key:

>> Press the assigned  directly opposite the number on the graphic display.

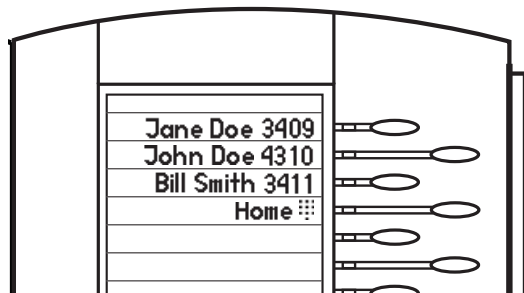

For more information on placing a call, refer to [Placing Calls](#) on page 3-2.

## Answering Calls

When you connect a SoundPoint IP Color Expansion Module to your phone, you can answer a call using one of the Line Keys.

### To answer a call using a SoundPoint IP Color Expansion Module Line Key:

>> Press the assigned  directly opposite the line with the fast flashing green LED indicator.

For more information on answering a call, refer to [Answering Calls](#) on page 3-4.

## Assigning Speed Dial Keys

You can associate contacts with Line Keys on the SoundPoint IP Color Expansion Module for single touch dialing of frequently used numbers. Speed Dial entries are consecutively placed next to assigned Line Keys.

For example, in the figure below, press the fourth **Line Key** to dial home.

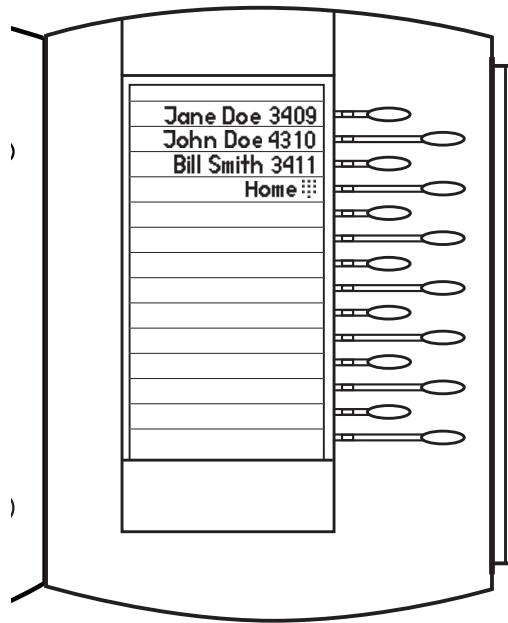

**To assign a new speed dial key:**

1. Press and hold an unassigned .  
A new empty entry in the contact directory is automatically opened allowing contact information to be added.
2. Press the **More** soft key.
3. Press the **Add** soft key.
4. (Optional.) Enter contact information  
Use the **1/A/a** soft key to select between numeric and upper/lower case alphanumeric modes.  
Use the **Encoding** soft key to access special characters in other languages.
5. Enter a contact number.  
The number must be unique (not already in the directory).
6. Change the Speed Dial Index field.  
It is automatically assigned to the next available index value. You may instead enter any unused speed dial number from 1 to 9999.



Polycom recommends that you assign speed dial index values consecutively. For example, if you assign the third Line Key to the speed dial index value “2”, assign the fourth Line Key to the speed dial index value “3”.

7. Press the **Save** soft key to accept your changes.
8. Press  to return to the idle screen.

For more information on assigning speed dial keys, refer to [Assigning Speed Dial Keys](#) on page 3-22.

## Using the Busy Lamp Field

The busy lamp field (BLF) feature allows you to monitor the hook status and remote party information of other users through the BLF LED indicators and display on the SoundPoint IP 670 phone with the attached Color Expansion Module. For more information, contact your system administrator.

The following figure shows the busy status of other users (for example, Louis, Jack, Don, William, Milton, and Z are busy on the phone):

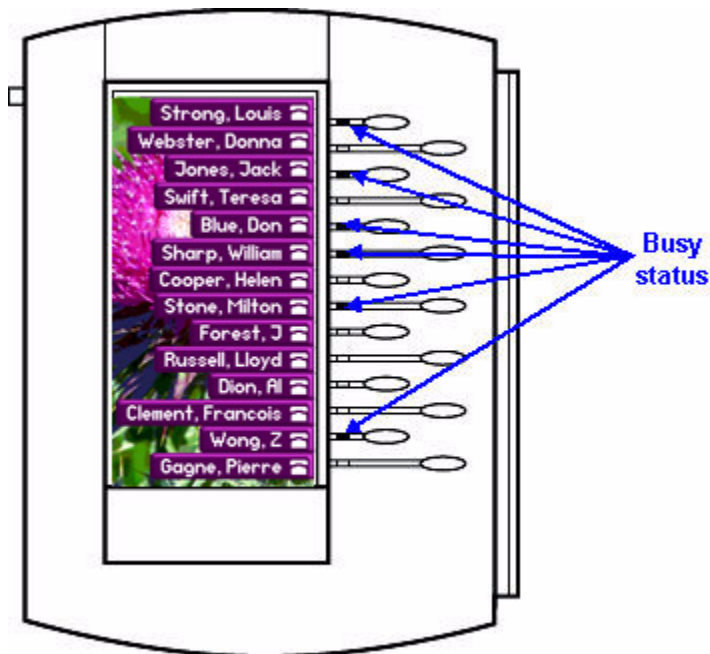

For more information, refer to “Quick Tip 37381: Enhanced BLF” at [http://www.polycom.com/usa/en/support/voice/soundpoint\\_ip/VoIP\\_Technical\\_Bulletins\\_pub.html](http://www.polycom.com/usa/en/support/voice/soundpoint_ip/VoIP_Technical_Bulletins_pub.html).



---

# Troubleshooting Your Phone

This chapter contains general troubleshooting information to help you solve any problems you might encounter when you use your Polycom® SoundPoint IP 670 phone. The tables in this chapter list possible trouble symptoms, the likely causes of these problems, and the recommended corrective actions to take. The topics include:

- [Power and Startup](#)
- [Controls](#)
- [Access to Screens and Systems](#)
- [Audio](#)
- [Calling](#)
- [Displays](#)
- [Productivity Suite](#)

To obtain more detailed troubleshooting information, you can access certain menus on your phone that test your phone hardware. For more information, see [Testing Phone Hardware](#) on page 6-7.

If you require additional assistance, contact your system administrator.

**Note**

Before restarting your phone, contact your system administrator. They may want to troubleshoot your phone in more detail before restarting it and losing current status information.

## Power and Startup

Symptom	Problem	Corrective Action
There are power issues.	The SoundPoint IP 670 phone has no power.	<p>Do one of the following:</p> <ul style="list-style-type: none"> <li>• Check if the phone is properly plugged into a functional AC outlet.</li> <li>• If using PoE, check that the ethernet cable is properly plugged into the phone and the outlet port. Contact your system administrator to ensure that you are using a powered port, enabled for PoE.</li> <li>• Make sure that the phone isn't plugged into a plug controlled by a light switch that is off.</li> <li>• If the phone is plugged into a power strip, try plugging it directly into a wall outlet instead.</li> <li>• Try the phone in another room where the electricity is known to be working on a particular outlet.</li> </ul>

## Controls

Symptom	Problem	Corrective Action
The dial pad does not work.	The dial pad on the SoundPoint IP 670 phone does not respond.	<p>Do one of the following.:</p> <ul style="list-style-type: none"> <li>• Verify that the phone is unlocked (the information status should not read "This Phone is Locked").</li> <li>• Check to make sure the phone is turned on (check display, other keys, lights, try to place a call).</li> <li>• Contact your system administrator.</li> </ul>



## Access to Screens and Systems

Symptom	Problem	Corrective Action
There is no response when you press a feature key.	The SoundPoint IP 670 phone is not in an active state.	<p>Do one of the following:</p> <ul style="list-style-type: none"> <li>Press the keys more slowly.</li> <li>To confirm that the line is active, press the <b>Menu</b> key, and then select <b>Status &gt; Lines &gt; Line Information</b>. From the Line Information page, verify that your phone line is registered.</li> <li>Contact your system administrator.</li> </ul>
The screen shows "Network Link is Down".	The LAN cable is not properly connected.	<p>Do one of the following:</p> <ul style="list-style-type: none"> <li>Check termination at the switch or hub (furthest end of the cable from the phone).</li> <li>Check that the switch or hub is operational (flashing link/status lights) or contact your system administrator.</li> <li>Check if the LAN port is active or inactive. Press the <b>Menu</b> key, and then select <b>Status &gt; Network &gt; Ethernet</b>. From the Ethernet page, scroll to the LAN port field and verify that it is active.</li> <li>Contact your system administrator.</li> </ul>

## Audio

Symptom	Problem	Corrective Action
There is no audio on the headset.	The connections are not correct.	Do one of the following: <ul style="list-style-type: none"> <li>Ensure the headset is plugged into the jack marked Headset at the rear of the phone.</li> <li>Ensure the headset amplifier (if present) is turned on and/or the volume is correctly adjusted. If the amplifier uses batteries, check that they are fully charged.</li> </ul>
You are using a headset and the people you call hear echo.	There may be an issue with the echo cancellation feature of your headset.	Do the following: <ul style="list-style-type: none"> <li>Press the <b>Menu</b> key, then select <b>Settings &gt; Basic &gt; Preferences &gt; Headset &gt; Echo Cancellation</b>. Using the arrow keys, select <b>Enabled</b>, and then press the <b>Select</b> soft key.</li> <li>Contact your system administrator.</li> </ul>

## Calling

Symptom	Problem	Corrective Action
There is no dial tone.	Power is not correctly applied to the SoundPoint IP 670 phone.	Do one of the following: <ul style="list-style-type: none"> <li>Check that the screen is illuminated.</li> <li>Make sure the LAN cable is inserted properly at the back of the phone (try unplugging and re-inserting the cable).</li> <li>If using in-line powering, have your system administrator check that the switch is supplying power to the phone.</li> </ul>
	Dial tone is not present on one of the audio modes.	Do one of the following: <ul style="list-style-type: none"> <li>Switch between Handset, Headset (if present) or Hands-Free Speakerphone to see if the dial tone is present for one of audio modes.</li> <li>If the dial tone exists on another audio mode, connect a different handset or headset to isolate the problem.</li> </ul>
	The phone is not registered.	Contact your system administrator.

Symptom	Problem	Corrective Action
The phone does not ring.	Ring volume is low.	Do one of the following: <ul style="list-style-type: none"> <li>Adjust the ringing level from the front panel using the volume up/down keys.</li> <li>Check the Alerting Destination from <b>Menu &gt; Basic &gt; Settings &gt; Preferences &gt; Audible Ringer.</b></li> </ul>
	Outbound or inbound calling is unsuccessful.	Do one of the following: <ul style="list-style-type: none"> <li>Place a call to the phone under investigation. Check that the screen indicates incoming call information.</li> <li>Lift the handset. Ensure the dial tone is present and place a call to another extension or number. Check that the screen changes in response.</li> </ul>
	The ringer is in silent mode.	Do one of the following: <ul style="list-style-type: none"> <li>Change the Ring Tone from <b>Menu &gt; Settings &gt; Basic &gt; Ring Type.</b></li> </ul>
"Service Unavailable" appears on the screen.	The phone, call server, configuration, or organization settings do not support the feature you are trying to access.	Contact your system administrator.
The line icon shows an unregistered line icon.	The phone line is unregistered.	Contact your system administrator.

## Displays

Symptom	Problem	Corrective Action
<p>There is no display. The display is incorrect. The display has bad contrast. The expansion module is not working.</p>	<p>Power is not correctly applied to the SoundPoint IP 670 phone or the SoundPoint IP Color Expansion Module.</p>	<p>Do one of the following:</p> <ul style="list-style-type: none"> <li>• Check that the screen is illuminated.</li> <li>• Make sure the LAN cable is inserted properly at the back of the phone.</li> <li>• If using Power over Ethernet (PoE), have your system administrator check the PoE switch, and that EM power is enabled in the Network Configuration menu (if using an expansion module).</li> <li>• Use the screen capture feature. Contact your system administrator to determine if it is enabled.</li> </ul>
	<p>The contrast needs adjustment.</p>	<p>Do one of the following:</p> <ul style="list-style-type: none"> <li>• Refer to <a href="#">Changing the Display Contrast</a> on page 5-2.</li> <li>• Restart the phone to obtain a default level of contrast.</li> <li>• Use the screen capture feature. Contact your system administrator to determine if it is enabled.</li> </ul>
	<p>Outbound or inbound calling is unsuccessful.</p>	<p>Do one of the following:</p> <ul style="list-style-type: none"> <li>• Place a call to the phone under investigation. Check that the screen indicates incoming call information.</li> <li>• Lift the handset. Ensure the dial tone is present and place a call to another extension or number. Check that the screen changes in response.</li> <li>• Use the screen capture feature. Contact your system administrator to determine if it is enabled.</li> </ul>
<p>The display flickers.</p>	<p>A certain type of older fluorescent lighting causes the display to appear to flicker.</p>	<p>Do one of the following:</p> <ul style="list-style-type: none"> <li>• Move the SoundPoint IP 670 SIP phone away from the lights.</li> <li>• Replace the lights in your work environment.</li> <li>• Use the screen capture feature. Contact your system administrator to determine if it is enabled.</li> </ul>

## Productivity Suite

Symptom	Problem	Corrective Action
<p>You are trying to access one of the following features, but it is not available on your phone:</p> <ul style="list-style-type: none"> <li>• Corporate Directory</li> <li>• Recording and Playback of Audio Calls</li> <li>• Managing Conferences</li> </ul>	<p>The license is not installed on your phone or it has expired.</p>	<p>Do the following:</p> <ul style="list-style-type: none"> <li>• Press the <b>Menu</b> key, then select <b>Status &gt; Licenses</b>.</li> <li>• Using the arrow keys, verify that the features that you want to use has a valid license.</li> <li>• Contact your system administrator.</li> </ul>

## Testing Phone Hardware

Your system administrator may ask you to access a diagnostics menu on your phone to test your phone hardware. From the diagnostics menu, you can test your phone's microphones, speaker, handset, third-party headset (if present), keypad mappings, and color LCD display. See your system administrator for instructions on how to perform these tests.

### To test your phone hardware:

>> Press , and then select **Status > Diagnostics > Test Hardware > Audio Diagnostics, Keypad Diagnostics, or Display Diagnostics**.



---

# Regulatory Notices

## Service Agreements

Please contact your Polycom Authorized Reseller for information about service agreements applicable to your product.

## Governing Law

This Limited Warranty and Limitation of Liability shall be governed by the laws of the State of California, U.S.A., and by the laws of the United States, excluding their conflicts of laws principles. The United Nations Convention on Contracts for the International Sale of Goods is hereby excluded in its entirety from application to this Limited Warranty and Limitation of Liability.

All rights reserved under International and Pan-American Copyright Conventions. No part of the contents of this manual may be copied, reproduced, or transmitted in any form or by any means, or translated into another language or format, in whole or part, without written consent from Polycom, Inc. Do not remove (or allow anybody else to remove) any product identification, copyright or other notices.

## Limitations of Liability

LIMITATION OF LIABILITY. TO THE FULL EXTENT ALLOWED BY LAW, POLYCOM EXCLUDES FOR ITSELF AND ITS SUPPLIERS ANY LIABILITY, WHETHER BASED IN CONTRACT OR TORT (INCLUDING NEGLIGENCE), FOR INCIDENTAL, CONSEQUENTIAL, INDIRECT, SPECIAL, OR PUNITIVE DAMAGES OF ANY KIND, OR FOR LOSS OF REVENUE OR PROFITS, LOSS OF BUSINESS, LOSS OF INFORMATION OR DATA, OR OTHER FINANCIAL LOSS ARISING OUT OF OR IN CONNECTION WITH THE SALE, INSTALLATION, MAINTENANCE, USE, PERFORMANCE, FAILURE, OR INTERRUPTION OF ITS PRODUCTS, EVEN IF POLYCOM OR ITS AUTHORIZED RESELLER HAS BEEN ADVISED OF THE POSSIBILITY OF SUCH DAMAGES, AND LIMITS ITS LIABILITY TO REPAIR, REPLACEMENT, OR REFUND OF THE PURCHASE PRICE PAID, AT POLYCOM'S OPTION. THIS DISCLAIMER OF LIABILITY FOR DAMAGES WILL NOT BE AFFECTED IF ANY REMEDY PROVIDED HEREIN SHALL FAIL OF ITS ESSENTIAL PURPOSE.

### **Polycom Limited Warranty and Limitation Liability**

**LIMITED WARRANTY.** Polycom warrants to the end user (“Customer”) that this product is expected to be free from defects in workmanship and materials, under normal use and service, for one year from the date of purchase from Polycom or its authorized reseller.

Polycom’s sole obligation under this express warranty is at Polycom’s option and expense, to repair the defective product or part, deliver to Customer an equivalent product or part to replace the defective item, or if neither of the two foregoing options are reasonably available, Polycom may, on its sole discretion, refund to Customer the purchase price paid for the defective product. All products that are replaced will become the property of Polycom. Replacement products or parts may be new or reconditioned.

Polycom is expected to warrant any replaced or repaired product or part for ninety (90) days from shipment, or the remainder of the initial warranty period, whichever is longer. Products returned to Polycom must be sent prepaid and packaged appropriately for safe shipment, and it is recommended that they be insured or sent by a method that provides for tracking of the package. Responsibility for loss or damage does not transfer to Polycom until the returned item is received by Polycom. The repaired or replaced item will be shipped to Customer, at Polycom’s expense, not later than thirty (30) days after Polycom receives the defective product, and Polycom will retain risk of loss or damage until the item is delivered to Customer.

The product software comes with 90-day software warranty, providing for software updates (minor releases/bug fixes). To continue to receive support, purchasing a maintenance contract is the most economical solution.

### **Exclusions**

Polycom will not be liable under this limited warranty if its testing and examination disclose that the alleged defect or malfunction in the product does not exist or results from:

- Failure to follow Polycom’s installation, operation, or maintenance instructions.
- Unauthorized product modification or alteration.
- Unauthorized use of common carrier communication services accessed through the product.
- Abuse, misuse, negligent acts or omissions of Customer and persons under Customer’s control; or
- Acts of third parties, acts of God, accident, fire, lightening, power surges or outages, or other hazards.

### **Warranty Exclusive**

IF A POLYCOM PRODUCT DOES NOT OPERATE AS WARRANTED ABOVE, CUSTOMER’S SOLE REMEDY FOR BREACH OF THAT WARRANTY SHALL BE REPAIR, REPLACEMENT, OR REFUND OF THE PURCHASE PRICE PAID, AT POLYCOM’S OPTION. TO THE FULL EXTENT ALLOWED BY LAW, THE FOREGOING WARRANTIES AND REMEDIES ARE EXCLUSIVE AND ARE IN LIEU OF ALL OTHER WARRANTIES, TERMS, OR CONDITIONS, EXPRESS OR IMPLIED, EITHER IN FACT OR BY OPERATION OF LAW, STATUTORY OR OTHERWISE, INCLUDING WARRANTIES, TERMS, OR CONDITIONS OF MERCHANTABILITY, FITNESS FOR A PARTICULAR PURPOSE, SATISFACTORY QUALITY, CORRESPONDENCE WITH DESCRIPTION, AND NON-INFRINGEMENT, ALL OF WHICH ARE EXPRESSLY DISCLAIMED. POLYCOM NEITHER ASSUMES NOR AUTHORIZES ANY OTHER PERSON TO ASSUME FOR IT ANY OTHER LIABILITY IN CONNECTION WITH THE SALE, INSTALLATION, MAINTENANCE OR USE OF ITS PRODUCTS.



## Safety and Compliance

### Part 15 FCC Rules

This device is compliant with Part 15 of the FCC Rules. Operation is subject to the following two conditions:

1. This device may not cause harmful interference, and
2. This device must accept any interferences received, including interference that may cause undesired operation.

### Class B Digital Device or Peripheral

Note: This equipment is tested and complies with the limits for a Class B digital device, pursuant to Part 15 of the FCC Rules. These limits are designed to provide reasonable protection against harmful interference in a residential installation. This equipment generates, uses, and can radiate radio frequency energy and, if not installed and used in accordance with the instructions, may cause harmful interference to radio communications. However, there is no guarantee that interference will not occur in a particular installation. If this equipment does cause harmful interference to radio or television reception, which can be determined by turning the equipment off and on, the user is encouraged to try to correct the interference by one or more of the following measures:

1. Reorient or relocate the receiving antenna.
2. Increase the separation between the equipment and receiver.
3. Connect the equipment into an outlet on a circuit different from that to which the receiver is connected.
4. Consult the dealer or an experience radio/TV technician for help.

### Modifications

In accordance with Part 15 of the FCC Rules, the user is cautioned that any changes or modifications not expressly approved by Polycom, Inc. could void the user's authority to operate the equipment. This equipment may not be used on a coin service or party line.

### Installation Instructions

Installation must be performed in accordance with all relevant national wiring rules.

L'Installation doit être exécutée conformément à tous les règlements nationaux applicable au filage électrique.

When using PoE (Power over Ethernet), the equipment is to be connected only to PoE networks without connections to the outside plant.

### Plugs Acts as Disconnect Device

The socket outlet to which this apparatus is connected must be installed near the equipment and must always be readily accessible.

La prise électrique à laquelle l'appareil est branché doit être installée près de l'équipement et doit toujours être facilement accessible.

### Industry Canada (IC)

This Class [B] digital apparatus complies with Canadian ICES-003.

Cet appareil numérique de la classe [B] est conforme à la norme NMB-003 du Canada.

### Safety and Compliance (continued)

#### CE and VCCI Mark

This SoundPoint IP 670 SIP is marked with the CE mark. This mark indicates compliance with EC Directory 1995/5/EC. A full copy of the Declaration of Conformity can be obtained from Polycom Ltd., 270 Bath Road, Slough, Berkshire, SL1 4DX, UK.

この装置は、情報処理装置等電波障害自主規制協議会（VCCI）の基準に基づくクラスB情報技術装置です。この装置は、家庭環境で使用することを目的としていますが、この装置がラジオやテレビジョン受信機に近接して使用されると、受信障害を引き起こすことがあります。  
取扱説明書に従って正しい取り扱いをして下さい。

#### WARNING Electrical Safety

To avoid electric shock, do not connect safety extra low voltage (SELV) circuits to teleconference station network (TNV) circuits. LAN ports contain SELV circuit, and WAN ports contain TNV circuits. Some LAN and WAN ports both use RJ-45 connectors. Use caution when connecting cables.

This product is rated 48Vdc, 0.375A. When used with the optional external power supply, the power supply shall be a Listed power supply with a LPS output, rated 48V, min. 0.375A.

#### Russian Compliance - SoundPoint IP 670

Ministry of Information Technologies & Communication of the Russian Federation – Declaration of Conformity. DoC # СПД-5207. Expiry 26 May 2014.

#### Operating Ambient Temperatures

Operating temperature: +32 to 104°F (0 to 40°C)

Relative humidity: 5% to 95%, noncondensing

Storage temperature: -40 to +160°F (-40 to +70°C)

#### Australia

Warning: This equipment will not operate when mains power fails.

#### Hearing Aid Compatibility (HAC)

This product is hearing aid compatible.

#### Waste Electrical and Electronic Equipment (WEEE)



All Polycom products that fall within the scope of the EU WEEE Directive carry the crossed wheeled bin symbol which advises customers not to recycle electronic products in the domestic waste stream but to recycle them safely as e-waste.

#### Restriction of Hazardous Substances Directive (RoHS)

All Polycom products comply with the requirements of the EU RoHS Directive. Statements of compliance can be obtained from TypeApproval@polycom.com.

### Safety and Compliance (continued)

#### Polycom Take Back

In addition to any mandated take back requirement, Polycom offers free recycling of its branded products to business users. Detailed information is available at [http://www.polycom.eu/documents/company/about\\_us/producer\\_responsibility\\_statement.pdf](http://www.polycom.eu/documents/company/about_us/producer_responsibility_statement.pdf).

#### New Zealand Telepermit

##### Polycom SoundPoint IP670 VoIP Telephone PTC 220/08/063

#### PTC General Warning

1. The grant of a Telepermit for any item of terminal equipment indicates only that Telecom has accepted that the item complies with minimum conditions for connection to its network. It indicates no endorsement of the product by Telecom, nor does it provide any sort of warranty. Above all, it provides no assurance that any item will work correctly in all respects with another item of Telepermitted equipment of a different make or model, nor does it imply that any product is compatible with all of Telecom's network services.

#### The Use of IP Networks through the PSTN

2. Internet Protocol (IP) by its nature introduces delay into speech signals as each data packet is formulated and addressed. Telecom Access Standards recommends that suppliers, designers and installers using this technology for calls to or from the PSTN refer to ITU E Model requirements in the design of their networks. The overall aim is to minimise delay, distortion and other transmission impairments, particularly for those calls involving cellular and international networks, which already suffer extensive delay.

#### The Use of Voice Compression through the PSTN

3. Because of the extensive delay already experienced when calling cellular and international networks, some of which is already caused by their use of voice compression technologies. Telecom Access Standards will only approve G711 voice technology for use on the PSTN. G711 is an 'Instantaneous Speech encoding Technique' whereas G729 and all its variants are considered 'Near Instantaneous' introducing additional delay into the speech signal.

#### Echo Cancellation

4. Echo cancellers are not normally required in the Telecom PSTN because geographic delays are acceptable where CPE return loss is maintained within Telepermit limits. However, those private networks making use of Voice over IP technology are required to provide echo cancellation for all voice calls. The combined effect of audio / VoIP conversion delay and IP routing delay can cause the echo cancellation time of 64 mS to be required.

#### Modification of this Polycom SoundPoint IP670 VoIP Telephone for the New Zealand Network

5. All samples of Polycom SoundPoint IP670 VoIP Telephones connected to the Telecom network shall be equipped with the following software batch Rev 3.0.2.0917. Equipped with this software batch the IP telephone is known to comply with the New Zealand speech transmission plan.

#### Korean Compliance

한국의 모든 SoundPoint IP 670 휴대 전화 출하

사용자 안내문

B 급기기(가정용 정보통신기기)

이 기기는 가정용으로 전자파적합등록을 한 기기로서 주거지역에서는 물론 모든 지역에서 사용할 수 있습니다.



# End-User License Agreement for Polycom<sup>®</sup> Software

This End-User License Agreement (“Agreement”) is a legal agreement between you (either an individual or a single entity) and Polycom, B.V for the Polycom Software Product licensed by Polycom B.V in Europe, the Middle East, Africa, and Asia Pacific or Polycom, Inc., for the Polycom Software Product licensed by Polycom, Inc. in the rest of the world (collectively, “Polycom”). The Software Product includes the computer software included herewith and may include associated media, printed materials and online or electronic documentation (“Software Product”). By clicking ‘I agree’ or by installing, copying, or otherwise using the Software Product, you agree to be bound by the terms of this Agreement. If you do not agree to the terms of this Agreement, do not install or use the Software Product, and return it to your place of purchase for a full refund.

The Software Product is protected by copyright laws and international copyright treaties, as well as other intellectual property laws and treaties. The Software Product is licensed (not sold) to you, and its use is subject to the terms of this Agreement.

## 1. GRANT OF LICENSE.

Subject to the terms of this Agreement, Polycom grants to you a nonexclusive license to install and use the Software Product included with the Polycom product that incorporates or uses the Software Product (the “Product”). You may use the Software Product only in connection with the use of the Product. You are not permitted to lease, rent, distribute or sublicense the Software Product or to use the Software Product in a time-sharing arrangement or in any other unauthorized manner. Further, no license is granted to you in the human readable code of the Software Product (source code). Except as provided below, this License Agreement does not grant you any rights to patents, copyrights, trade secrets, trademarks, or any other rights in respect to the Software Product.

## 2. DESCRIPTION OF OTHER RIGHTS AND LIMITATIONS.

**2.1 Limitations on Reverse Engineering, Decompilation, and Disassembly.** You may not reverse engineer, decompile, or disassemble the Software Product, except and only to the extent that such activity is expressly permitted by applicable law notwithstanding this limitation. The Software Product is licensed as a single product. Its component parts may not be separated for use on more than one Product.

**2.2 Backup.** Except as expressly provided for under this Agreement, you may not copy the Software Product, except, however, you may keep one copy of the Software Product and, if applicable, one copy of any previous version for back-up purposes, only to be used in the event of failure of the original. All copies of the Software Product must be marked with the proprietary notices provided on the original Software Product. You may not reproduce the supporting documentation accompanying the Software Product.

**2.3 Modifications.** You may not modify, translate, or create derivative works of the Software Product.

**2.4 Proprietary Notices.** You may not remove or obscure any proprietary notices on or in the Software Product or the supporting documentation.

**2.5 Software Transfer.** You may permanently transfer all of your rights under this Agreement provided you retain no copies, you transfer all of the Software Product (including all component parts, the media, any printed materials, any upgrades, this Agreement, and, if applicable, the Certificate of Authenticity), and any recipient agrees to the terms of this Agreement. If the Software Product is an upgrade, any transfer must include all prior versions of the Software Product. However, if the Software Product is marked “Not for Resale” or “NFR,” you may not resell it or otherwise transfer it for value.

**2.6 Copyright.** All title and copyrights in and to the Software Product (including, but not limited to, any images, photographs, animations, video, audio, music, text, and “applets” incorporated into the Software Product), the accompanying printed materials, and any copies of the Software Product are owned by Polycom or its suppliers. The Software Product is protected by copyright laws and international treaty provisions. Title, ownership rights, and intellectual property rights in the Software Product shall remain In Polycom or its suppliers. Title and related rights in the content accessed through the Software Product is the property of such content owner and may be protected by applicable law. This Agreement gives you no rights in such content.

**2.7 Confidentiality.** The Software Product contains valuable proprietary information and trade secrets of Polycom and its suppliers and you shall protect the confidentiality of, and avoid disclosure and unauthorized use of, the Software Product.

**2.8 Dual-Media Software.** You may receive the Software Product in more than one medium. Regardless of the type or size of medium you receive, you may use only one medium that is appropriate for your single Product. You may not use or install the other medium on another Product.

**2.9 Reservation.** Polycom reserves all rights in the Software Product not expressly granted to you in this Agreement.

### **3. SUPPORT SERVICES.**

Polycom may provide you with support services related to the Software Product (“Support Services”). Use of Support Services is governed by the Polycom policies and programs described in the Polycom-provided materials. Any supplemental software code provided to you as part of the Support Services is considered part of the Software Product and is subject to the terms and conditions of this Agreement. With respect to technical information you provide to Polycom as part of the Support Services, Polycom may use such information for its business purposes, including for product support and development. Polycom will not utilize such technical information in a form that personally identifies you.

### **4. TERMINATION.**

Without prejudice to any other rights, Polycom may terminate this Agreement if you fail to comply with any of the terms and conditions of this Agreement. In such event, you must destroy all copies of the Software Product and all of its component parts. You may terminate this Agreement at any time by destroying the Software Product and all of its component parts.

### **5. UPGRADES.**

If the Software Product is labeled as an upgrade, you must be properly licensed to use the software identified by Polycom as being eligible for the upgrade in order to use the Software Product. A Software Product labeled as an upgrade replaces and/or supplements the software that formed the basis for your eligibility for the upgrade. You may use the resulting upgraded Software Product only in accordance with the terms of this Agreement. If the Software Product is an upgrade of a component of package of software programs that you licensed as a single product, the Software Product may be used and transferred only as part of that single Software Product package and may not be separated for use on more than one Product.

### **6. WARRANTY AND WARRANTY EXCLUSIONS.**

**6.1 Limited Warranty.** Polycom warrants that (a) the Software Product will perform substantially in accordance with the accompanying documentation for a period of ninety (90) from the date of receipt by you, and (b) any Support Services provided by Polycom shall be substantially as described in applicable written materials provided to you by Polycom, and Polycom support engineers will make commercially reasonable efforts to solve any problem issues. Polycom does not warrant that your use of the Software Product will be uninterrupted or error free, or that all defects in the Software Product will be corrected. Polycom’s sole obligation under this express warranty shall be, at Polycom’s option and expense, to

refund the purchase price paid by you for any defective software product which is returned to Polycom with a copy of your receipt, or to replace any defective media with software which substantially conforms to applicable Polycom published specifications. Any replacement Software Product will be warranted for the remainder of the original warranty period or thirty (30) days, whichever is longer.

**6.2 Warranties Exclusive.** If this Software Product does not operate as warranted above, your sole remedy for breach of that warranty shall be repair, replacement, or refund of the purchase price paid, at Polycom's option. TO THE FULL EXTENT ALLOWED BY LAW, THE FOREGOING WARRANTIES AND REMEDIES ARE EXCLUSIVE AND ARE IN LIEU OF ALL OTHER WARRANTIES, TERMS OR CONDITIONS, EXPRESS OR IMPLIED, EITHER IN FACT OR BY OPERATION OF LAW, STATUTORY OR OTHERWISE, INCLUDING WARRANTIES, TERMS OR CONDITIONS OF MERCHANTABILITY, FITNESS FOR A PARTICULAR PURPOSE, SATISFACTORY QUALITY, CORRESPONDENCE WITH DESCRIPTION, AND NON-INFRINGEMENT, ALL OF WHICH ARE EXPRESSLY DISCLAIMED. POLYCOM NEITHER ASSUMES NOR AUTHORIZES ANY OTHER PERSON TO ASSUME FOR IT ANY OTHER LIABILITY IN CONNECTION WITH THE SALE, INSTALLATION, MAINTENANCE, OR USE OF THIS SOFTWARE PRODUCT.

POLYCOM SHALL NOT BE LIABLE UNDER THIS WARRANTY IF ITS TESTING AND EXAMINATION DISCLOSE THAT THE ALLEGED DEFECT OR MALFUNCTION IN THE SOFTWARE PRODUCT DOES NOT EXIST OR WAS CAUSED BY YOUR OR ANY THIRD PERSON'S MISUSE, NEGLIGENCE, IMPROPER INSTALLATION OR TESTING, UNAUTHORIZED ATTEMPTS TO MODIFY THE PRODUCT, OR ANY OTHER CAUSE BEYOND THE RANGE OF THE INTENDED USE, OR BY ACCIDENT, FIRE, LIGHTNING, POWER CUTS OR OUTAGES, OTHER HAZARDS, OR ACTS OF GOD.

## **7. LIMITATION OF LIABILITY.**

TO THE MAXIMUM EXTENT PERMITTED BY APPLICABLE LAW, IN NO EVENT SHALL POLYCOM OR ITS SUPPLIERS BE LIABLE FOR ANY SPECIAL, INCIDENTAL, INDIRECT, OR CONSEQUENTIAL DAMAGES WHATSOEVER (INCLUDING, WITHOUT LIMITATION, DAMAGES FOR LOSS OF BUSINESS PROFITS, BUSINESS INTERRUPTION, LOSS OF BUSINESS INFORMATION, OR ANY OTHER PECUNIARY LOSS) ARISING OUT OF THE USE OR INABILITY TO USE THE SOFTWARE PRODUCT OR THE PROVISION OF OR FAILURE TO PROVIDE SUPPORT SERVICES, EVEN IF POLYCOM HAS BEEN ADVISED OF THE POSSIBILITY OF SUCH DAMAGES. IN ANY CASE, POLYCOM'S ENTIRE LIABILITY SHALL BE LIMITED TO THE GREATER OF THE AMOUNT ACTUALLY PAID BY YOU FOR THE SOFTWARE PRODUCT OR U.S. \$5.00; PROVIDED, HOWEVER, IF YOU HAVE ENTERED INTO A POLYCOM SUPPORT SERVICES AGREEMENT, POLYCOM'S ENTIRE LIABILITY REGARDING SUPPORT SERVICES SHALL BE GOVERNED BY THE TERMS OF THAT AGREEMENT.

## **8. DISCLAIMER.**

Some countries, states, or provinces do not allow the exclusion or limitation of implied warranties or the limitation of incidental or consequential damages for certain products supplied to consumers, or the limitation of liability for personal injury, so the above limitations and exclusions may be limited in their application to you. When the implied warranties are not allowed to be excluded in their entirety, they will be limited to the duration of the applicable written warranty. This warranty gives you specific legal rights which may vary depending on local law.

## **9. EXPORT CONTROLS.**

The Software Product may not be downloaded or otherwise exported or re-exported (i) into (or to a national or resident of) Cuba, North Korea, Iran, Syria, Sudan, or any other country to which the U.S. has embargoed goods; or (ii) to anyone on the U.S. Treasury Department's List of Specially Designated Nationals or the U.S. Commerce Department's Table of Denial Orders. By downloading or using this Software Product, you are agreeing to the foregoing and you are representing and warranting that you are

not located in, under the control of, or a national or resident of any such country or on any such list. If you obtained this Software Product outside of the United States, you are also agreeing that you will not export or re-export it in violation of the laws of the country in which it was obtained.

## **10. MISCELLANEOUS.**

**10.1 Governing Law.** This Agreement shall be governed by the laws of the State of California, as such laws are applied to agreements entered into and to be performed entirely within California between California residents, and by the laws of the United States. The United Nations Convention on Contracts for the International Sale of Goods (1980) is hereby excluded in its entirety from application to this Agreement.

**10.2 General.** This Agreement represents the complete agreement concerning this license and may amended only by a writing executed by both parties. If any provision of this Agreement is held to be unenforceable, such provision shall be reformed only to the extent necessary to make it enforceable.

**10.3 Contact.** If you have any questions concerning this Agreement, or if you desire to contact Polycom for any reason, please contact the Polycom office serving your country.

**10.4 U.S. Government Restricted Rights.** The software and documentation provided by Polycom pursuant to this Agreement are "Commercial Items," as the term is defined at 48 C.F.R. §2.101, consisting of "Commercial Computer Software" and "Commercial Computer Software Documentation," as such terms are used in 48 C.F.R. §12.212 or 48 C.F.R. §227.7202, as applicable. Consistent with 48 C.F.R. §12.212 or 48 C.F.R. §§227.7202-1 through 227.7202-4, as applicable, the Commercial Computer Software and Commercial Computer Software Documentation are licensed to United States Government end users (1) only as Commercial Items and (2) with only those rights as are granted to all other users pursuant to the terms of this Agreement.

[www.polycom.com](http://www.polycom.com)

**Corporate Headquarters:** 6001 America Center Drive, San Jose, CA 95164,  
USA  
Phone: 925.924.6000



## Free Manuals Download Website

<http://myh66.com>

<http://usermanuals.us>

<http://www.somanuals.com>

<http://www.4manuals.cc>

<http://www.manual-lib.com>

<http://www.404manual.com>

<http://www.luxmanual.com>

<http://aubethermostatmanual.com>

Golf course search by state

<http://golfingnear.com>

Email search by domain

<http://emailbydomain.com>

Auto manuals search

<http://auto.somanuals.com>

TV manuals search

<http://tv.somanuals.com>