

# Ceiling DocCam™ II User Manual

**ClearOne**  
*You're Virtually There<sup>SM</sup>*

## Table of Contents

<b>Introduction</b> .....	<b>1</b>
Services and support .....	1
Product returns .....	1
Unpacking .....	2
Important safeguards .....	3
Product overview .....	4
<b>Installation</b> .....	<b>7</b>
Before you install .....	7
Mounting the camera .....	7
Connecting cables .....	9
Configuring for remote controls .....	10
Programming presets .....	11
<b>Operation</b> .....	<b>12</b>
Using your codec remote .....	12
Using your ClearOne remote .....	12
Viewing areas .....	13
Custom cable information .....	13
<b>Troubleshooting</b> .....	<b>14</b>
<b>Appendix</b> .....	<b>15</b>
Specifications .....	15
Warranty .....	16
FCC Part 15/ICES-003 Compliance .....	18
RS-232 control information .....	20

Ceiling DocCam II™ User Manual

ClearOne Part No. 800-171-066 May 2004 (Rev. 1.0)

© 2004 ClearOne Communications, Inc. All rights reserved. No part of this document may be reproduced in any form or by any means without written permission from ClearOne Communications. Printed in the United States of America. ClearOne Communications reserves specific privileges. Other product names may be trademarks of their respective owners. Information in this document is subject to change without notice.

## Introduction

The Ceiling DocCam™ II is a ceiling-mounted document camera that displays images on monitors, plasma screens, video projectors and videoconferencing systems. It is ideal for presenting or sharing any type of object or document, from detailed images to large blueprints. The camera is installed in the ceiling above a conference table and has a low profile design that is appropriate for any room decor. Additional features include:

- **Laser pointer** providing accurate document positioning.
- **Single cable** carrying power, video and control, simplifying installation and connection.
- **IR remote** with increased functionality including zooming presets, brightness control and laser operation.
- **User accessible DIP switches** that allow the Ceiling DocCam II to respond to different video codec remotes.

## Services and support

If you need additional information on how to install, set up or operate your Ceiling DocCam II, please contact us. We welcome and encourage your comments so we can continue to improve our products and better meet your needs.

### Technical support

Tel: 1-800-283 5936 (USA) or  
1-801-974-3760

Fax: 1-801-977-0087

E-mail: [tech.support@clearone.com](mailto:tech.support@clearone.com)

Web: [www.clearone.com](http://www.clearone.com)

### Sales and customer service

Tel: 1-800-945-7730 (USA) or  
1-801-975-7200

Fax: 1-800-933-5107 (USA) or  
1-801-977-0087

E-mail: [sales@clearone.com](mailto:sales@clearone.com)

## Product returns

All product returns require a return materials authorization (RMA) number. Please contact ClearOne Technical Support before attempting to return your product. Make sure you return all the items that shipped with your product.

## Unpacking

Ensure that you received the following parts:

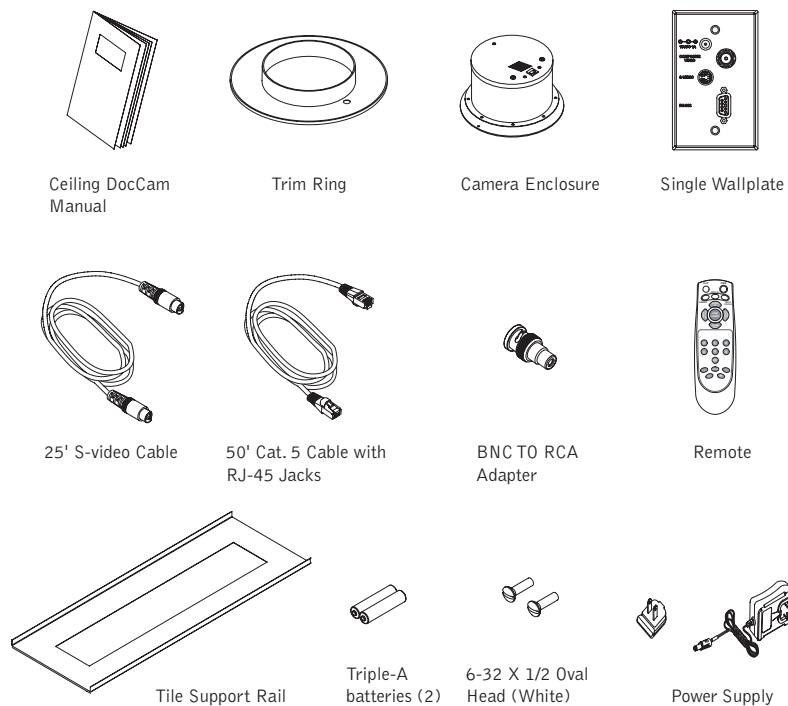





Figure 1. Unpacking items

 **Note:** ClearOne is not responsible for product damage incurred during shipment. You must make claims directly with the carrier. Inspect your shipment carefully for obvious signs of damage. If the shipment appears damaged, retain the original boxes and packing material for inspection by the carrier. Contact your carrier immediately.

## Important safeguards

- Read and understand all instructions before using.
- Do not operate the Ceiling DocCam II if the power cord is damaged or if the Ceiling DocCam II has been dropped or damaged. A qualified service technician must examine the Ceiling DocCam II before operating.
- Do not attempt to take the Ceiling DocCam II apart. There are no user-serviceable components inside.
- Clean exterior of Ceiling DocCam II by wiping with a clean, damp cloth; do not use abrasive chemicals.
- Do not store or operate the Ceiling DocCam II under the following conditions:
  - ~ A temperature above 104° F (40° C) or below 32° F (0° C)
  - ~ Environments with high humidity
  - ~ Dusty environments
  - ~ In inclement weather
  - ~ Under severe vibration

 **Attention:** Use only the power supply provided with the Ceiling DocCam II. Use of any unauthorized power supply will void any and all warranties.

 **Attention:** Laser radiation is present. To avoid eye damage, do not stare directly into laser beam.

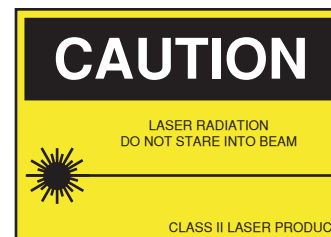

## Product overview

### Camera enclosure

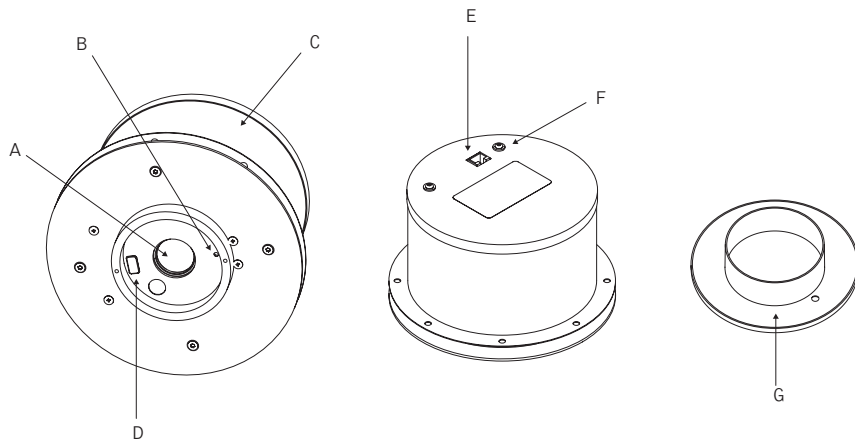

Figure 2. Front and back of camera enclosure and trim ring

- A. **Lens.** The lens has motorized zoom capabilities up to 25X optical and 12X digital for a total of 300X.
- B. **Positioning indicator/laser.** The laser ensures proper document orientation by indicating where a document should be placed for best viewing. Laser displays for five seconds when camera is first powered on.
- ⚠ Attention:** Laser radiation is present. To avoid eye damage, do not stare directly into laser beam.
- C. **Camera enclosure.** This metal enclosure houses the camera electronics.
- D. **DIP switches.** These are user configurable switches for specific third party remotes.
- E. **RJ-45 connector.** This connector provides S-video, composite video, RS-232 and power to the rear of the wall plate using the provided 50' Cat. 5 plenum-rated cable.
- F. **Threaded inserts.** These inserts enable attachment to a standard electrical box (not provided) using standard conduit connectors.
- G. **Trim ring.** The trim creates a finished look when the camera is installed and holds the camera and tile together.

### Front and back wall plate connections

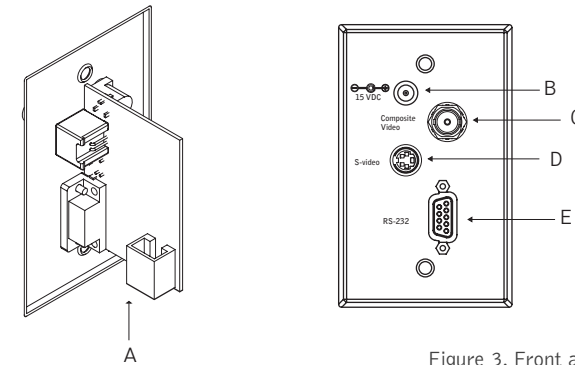

Figure 3. Front and back wall plate

- A. **RJ-45 Connector.** The RJ-45 jack connects to the RJ-45 connector on the camera enclosure using a Cat. 5 cable.
  - B. **15 VDC.** The 15 VDC power supply jack.
  - C. **Composite.** This output jack allows the Ceiling DocCam II to be connected to video display devices that require a composite signal such as codecs, TV monitors, VCRs and LCD and DLP projectors.
  - D. **S-video.** This output jack allows the Ceiling DocCam II to be connected to video display devices that require an S-video signal such as video conferencing systems, video capture cards, TVs and video to USB adapters. If your video display device has both S-video and composite, use S-video for the highest quality image.
- Both the S-video and composite outputs are always live making it possible to connect the camera to two separate display devices at the same time.
- E. **RS-232.** This output allows you to connect the camera to control systems such as Crestron or AMX.

## Remote

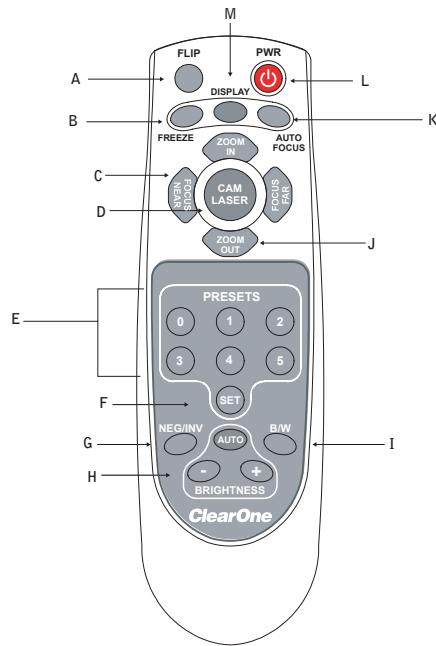

Figure 4. ClearOne remote

- A. **Flip.** Rotates image 180° on video display device.
- B. **Freeze.** Freezes current image until you press again to release and return to live view.
- C. **Focus.** Focus Near for close up views. Focus Far for distance views.
- D. **Cam Laser.** Displays a laser pointer with momentary on (5 seconds) and auto off. Use the laser pointer to position documents directly under the camera.
- E. **Presets.** Stores up to six programmed camera setting presets (0-5).
- F. **Set.** Press to program presets.
- G. **Neg/Inv.** Makes image a negative. This is useful in hiding highlighted portions of documents, by making them appear not highlighted.
- H. **Brightness.** Auto automatically adjusts brightness, (+) manually brightens image and (-) manually dims image.
- I. **B/W.** Black/White displays image in black and white.
- J. **Zoom.** Zoom In zooms for small images such as a stamp. Zoom Out zooms out for large images or documents such as a blueprint.
- K. **Auto Focus.** Automatically focuses an image.
- L. **Power.** Turns the camera on or off.
- M. **Display.** Shows icons for all camera controls and any messages associated with the presets.

## Installation

### Before you install

The following equipment is needed for proper installation:

- String or plumb bob
- Utility knife
- Flathead screwdriver

Be sure to check above the ceiling tile where you plan to install the camera to make sure the area is clear and that there is enough room for the Ceiling DocCam II and all of its components. Use the string or plumb bob to align and center the camera directly above the viewing area. Use the utility knife to cut a hole in the tile and the screwdriver to attach the white trim ring to the camera enclosure.

### Mounting the camera

The Ceiling DocCam II is an integrated document/object camera designed to be installed in a suspended ceiling above a table. Recommended ceiling heights are between 8 and 12 feet. The camera module enclosure and the tile support rail allow for exceptional positioning freedom when used with 2'x2' and 2'x4' ceiling tiles. The camera may be used with any tile 2' wide. The tile support rail distributes the weight of the camera into the grid and prevents tile warping. The diagram in Figure 5 shows the completed installation.

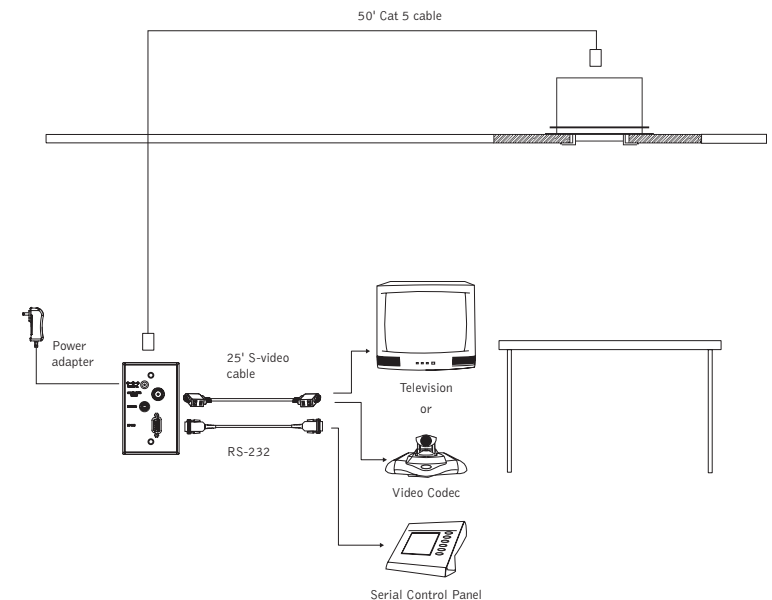

Figure 5. Complete installation

## To mount the camera

1. Attach a string or plumb bob to the ceiling tile with a thumb tack.
2. Position the string directly over ample table space or work surface to allow easy document and object positioning.
3. Using a sharp utility knife, score a  $3\frac{1}{2}$ " diameter hole into the front of the tile centered on the string.

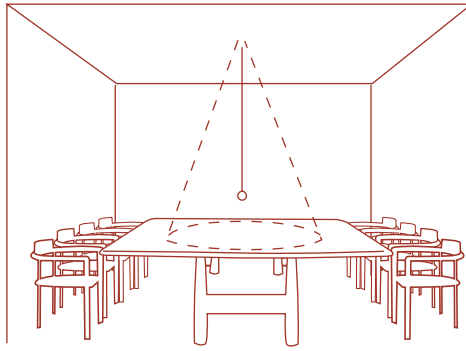

Figure 6. Positioning the camera

4. Cut out the  $3\frac{1}{2}$ " hole.
5. Place the tile support rail on the back side of the tile and center over the hole.
6. Rotate the camera enclosure module so that the positioning indicator is oriented toward the monitor or display device. This position is standard document camera orientation.

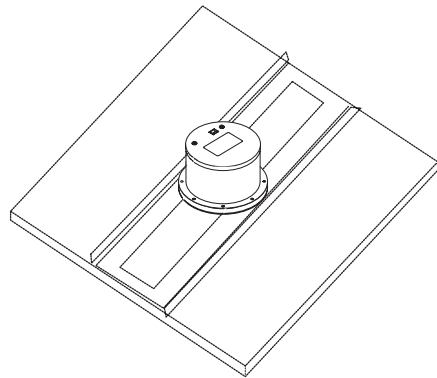



Figure 7. Support braces on 2'x2' ceiling tile

-  **Note:** If the positioning indicator is not oriented toward the monitor or display device, your image will not be oriented properly.
7. Fit the tile ring through the hole in the tile, sandwiching the tile support between the camera enclosure and the tile. The camera tile ring will fit into the  $3\frac{1}{2}$ " opening from the rear of the tile.
  8. Position the tile above the ceiling.
  9. Attach the white trim ring to the camera enclosure from the front of the tile and tighten gently. This will pull the trim ring, camera module and tile support rail together and firmly hold the camera in position against the ceiling tile.

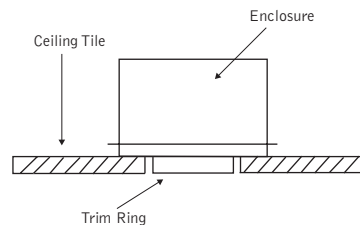

Figure 8. Enclosure and trim ring side view

## Connecting cables

A single RJ-45 cable connects to the back of the wall plate providing S-video, composite video, power and RS-232 control. The front of the wall plate provides the break-out connections for S-video, composite video, power and RS-232 control. The wall plate may be attached to a standard single gang wall box or placed in an equipment rack in a surface mount wall box. A 50' Cat. 5 cable is included to connect the camera enclosure to the back of the wall plate. It is best to use the included Cat. 5 cable. In situations where a third party cable is necessary, the cable must be between 10' and 200' long. Using a longer cable may cause the camera to lose power.

### To connect to the wall plate

1. Plug the Cat. 5 cable into the RJ-45 connector on the rear of the camera enclosure.
2. Feed the wire through the ceiling to where the wall plate will be connected.
3. Connect the other end of the Cat. 5 cable to the RJ-45 connector on the back of the wall plate.
4. Install the wall plate into an electrical box.

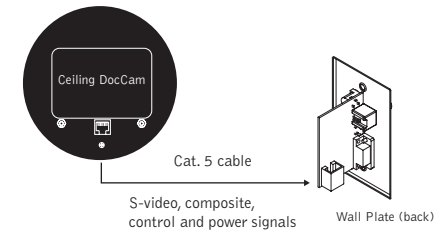



Figure 9. Enclosure with back of wall plate

### To connect to the display device and control system

1. Connect the 15 VDC power supply plug into the 15 VDC jack.
2. Plug the power supply into a standard wall outlet (100V-240V).
3. Using the 25' S-video cable, connect the S-video jack to the display device at the S-video connector.

 **Note:** For display devices that do not have an S-video connector, use a composite cable (not included) to connect the composite jack to the composite connector on your display device.

4. Connect a serial cable to the control system, if needed.

 **Attention:** Use only the power supply provided with the Ceiling DocCam II. Use of any unauthorized power supply will void warranty.

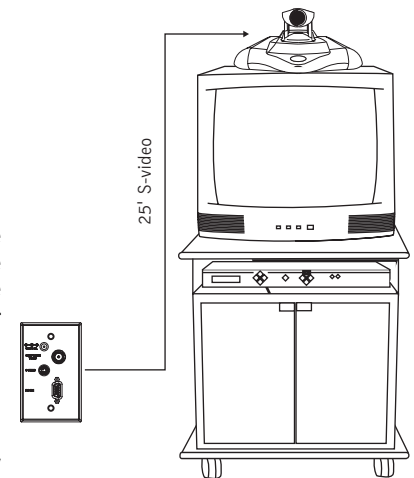

Figure 10. Connection to a video codec

## Configuring for remote controls

The Ceiling DocCam II can be programmed to work with the remotes listed below. DIP switches on the camera enclosure must be configured in order to work with these remotes. See Figure 2 on page 4 for exact location of DIP switches. Use the following diagram to program your Ceiling DocCam II correctly.

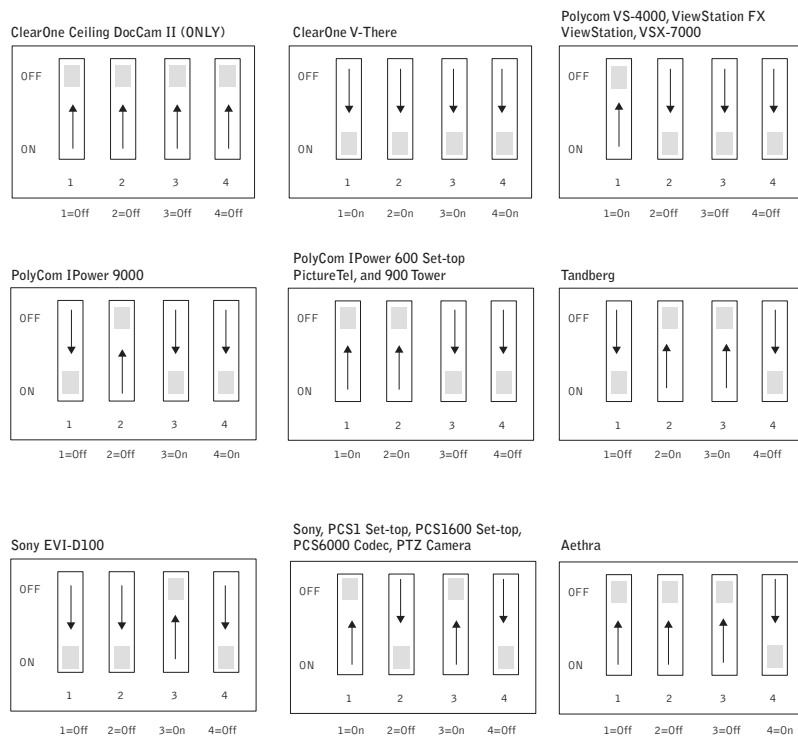

Figure 11. DIP switch configurations

**Note:** For best performance of the VISCA™ (a trademark of Sony Corporation) commands, set DIP switches to the ClearOne configuration when the camera is connected to the control port of a codec.

**Note:** After changing the DIP switches, camera must be power cycled.

## Programming presets

Presets are used to program defined positions of the camera into a simple, one button preset. You can switch easily from a zoomed in position on a small document to a zoomed out position for documents such as blueprints. This saves the hassle of zooming in and out when presenting documents of a variety of sizes. You can program your ClearOne IR remote with six different presets labeled 0-5.

**Note:** These presets will only work with the ClearOne IR remote.

### To program a preset

1. Zoom in or out to desired view.
2. Press the Set button once. The on-screen notification will indicate "Set number."
3. Press the selected preset button (0-5).

**Note:** If you want to reset a preset, just program a new preset using that same number. The new preset will override the old one.

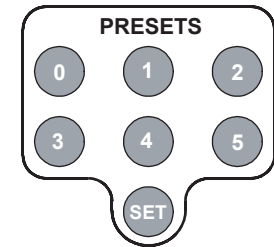

Figure 12. Presets

## Operation

### Using your codec remote

The only function you can control on the Ceiling DocCam II from your codec remote is the zoom in or zoom out. All other functions must be performed using the ClearOne remote.

### Using your ClearOne remote

The ClearOne remote will function in all DIP switch configurations. Please refer to Figure 4 on page 6 for a complete list of remote buttons.

#### To zoom

1. Press the **Zoom Out** button to view large documents.
2. Press the **Zoom In** button to view documents up close.

 **Note:** When the zoom indicator passes the divider on the display bar, the camera moves from optical zoom to digital zoom. Optical zoom uses the optical lens to enlarge the image. Digital zoom crops a small section of the picture and then enlarges it to screen size. This can leave the zoomed in image looking pixelated.

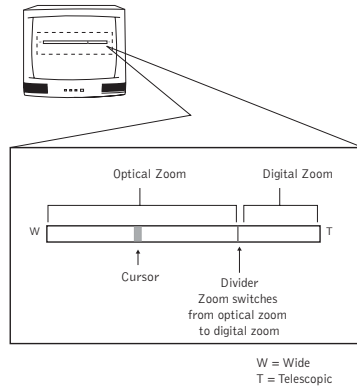

Figure 13. Zoom display

#### To focus an image

1. Press the **Auto Focus** button to automatically focus the camera.
2. Press the **Focus Far** button to manually focus a zoomed out view.
3. Press the **Focus Near** button to manually focus a zoomed in view.

#### To use the camera laser

1. Press the **Cam Laser** button.
2. Center document under laser.

The camera laser will turn off automatically after 5 seconds.

#### To adjust the brightness

1. Press the **Auto** button to have the camera automatically adjust the brightness of the on-screen image.
2. Press the **-** button to manually dim the on-screen image.
3. Press the **+** button to manually brighten the on-screen image.

## Viewing areas

Viewing area depends on the distance between the ceiling and the table. Use the following tables to determine the maximum and minimum viewing areas of the Ceiling DocCam II for distances of 5.5', 6.5' and 7.5'. (Most tables are about 2.5' and ceiling heights vary between 8', 9' and 10'). If the distance differs from the examples given, use the table to estimate the viewing area. There is also a distance calculator available online at [www.clearone.com](http://www.clearone.com).

#### Distance between the ceiling and table : 5.5'

	Height	Width	Diagonal
Zoomed out max	2.90'	3.87'	4.84'
Zoomed in optical 25x	.13'	.17'	.21'
Zoomed in optical 25x digital 12x	.06'	.09'	.11'

#### Distance between the ceiling and table : 6.5'

	Height	Width	Diagonal
Zoomed out max	3.43'	4.58'	5.72'
Zoomed in optical 25x	.15'	.20'	.25'
Zoomed in optical 25x digital 12x	.08'	.10'	.13'

#### Distance between the ceiling and table : 7.5'

	Height	Width	Diagonal
Zoomed out max	3.96'	5.28'	6.60'
Zoomed in optical 25x	.17'	.23'	.29'
Zoomed in optical 25x digital 12x	.09'	.12'	.15'

## Custom cable information

If you need a longer cable, for best performance use a Cat. 5E or Cat. 6 cable with a 200' maximum and 24 AWG. Use the following pinouts for the Cat. 5 or Cat. 6 cable.

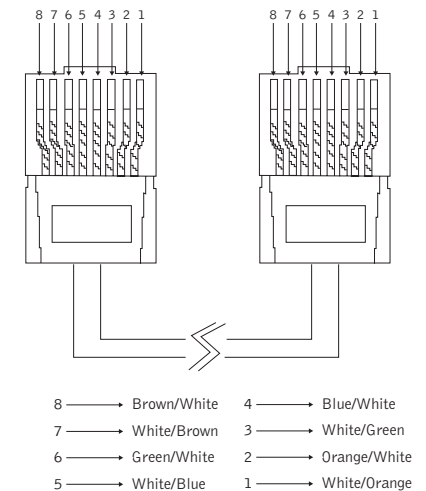

Figure 14. Cable pinouts



## Troubleshooting

Problem	Try this
No video image	<p>Verify that the Cat. 5 is connected between the RJ-45 jack on the back of the camera module enclosure and the RJ-45 jack on the back of the wall plate.</p> <p>Make sure the provided 15 VDC power supply is plugged into a wall outlet and the 15 VDC jack on the wall plate.</p> <p>Check the S-video or composite cables to verify they are properly connected, ensure video display device is powered and make sure the display device is set to the correct video source.</p>
The IR remote control does not work	<p>Verify fresh batteries are installed and positioned correctly.</p> <p>Remove power supply plug from the 15 VDC jack on the wall plate. Wait a few seconds and reinsert the power supply plug.</p>
Can't see an entire drawing/page clearly on the video screen	<p>When large documents, such as blueprints, are being viewed, the smallest details may not appear perfectly. The resolution only allows zoomed in images to be clear. However, in viewing normal size documents, details should be clear.</p>

## Appendix

### Specifications

#### Dimensions (Height x Diameter)

Enclosure: 4.5" x 6.5" (11.43 x 16.51 cm)  
 Ceiling cutout: 3½" (8.9 cm) diameter  
 Trim ring: 5.5" (14 cm) diameter white

#### Weight

4 lb (1.81 kg)

#### Video Format

NTSC or PAL

#### Image Sensor

1/6 Type Super

#### Pixels

Effective: Approx. 688,000

#### Horizontal Resolution

480+ TV lines

#### Sensitivity

2.5 Lux

#### SNR (Min)

49 dB

#### Camera Features

White balance: Auto  
 Brightness: Auto/Manual  
 Backlight compensation: Auto  
 Iris: Auto  
 Shutter: Auto exposure  
 Focus: Auto/Manual  
 6 Presets  
 Laser (momentary-on for document positioning)  
 Image Freeze  
 Image Flip  
 Black and White (color off)  
 Pos/Neg - Negative Art

#### Focal Range

Infinity to 800mm (Telescopic) -35mm (Wide)

#### Lens (Horizontal Angle)

45 degrees (wide end) to  
 2.0 degrees (telescopic end)

#### Zoom

Optical 25X zoom, f=2.4 mm (wide) to 60 mm (tele), F1.6 to F2.7  
 Digital 12X (300X total with optical zoom)

#### Video Output

S-video and composite video (concurrent)

#### Control

IR remote (Either ClearOne or Selectable),  
 VISCA and IP control with optional Rack  
 Mount Interface Kit

#### Control Interface

VISCA (TTL Signal Level; Baud Rate: 9.6Kbps,  
 19.2Kbps; Stop Bit: 1 Selectable)

#### Wall Plate

S-video, composite video, power, RS-232

#### Enclosure

Plenum-rated

#### Power

Power Supply: 15 VDC,  
 100-240 VAC, 50/60 HZ  
 Consumption: 1.0 mA

#### Operating Temperature

32° F to 122° F (0° C to 50° C)

#### Cables

50' (15.24 m) plenum Cat. 5 cable with RJ-45  
 connectors, 25' (7.62 m) S-video cable

#### Models

910-171-066  
 910-171-066-PAL

## Warranty

ClearOne Communications, Inc. (Manufacturer) warrants that this product is free of defects in both materials and workmanship. Should any part of this product be defective, the Manufacturer agrees, at its option, to:

- Repair or replace any defective part free of charge (except transportation charges) for a period of two years from the date the end user is invoiced for the product, provided the end user returns the product to ClearOne Communications or an authorized ClearOne dealer according to the Product Return and Repair statement set forth below;

This warranty excludes assembled products not manufactured by the Manufacturer whether or not they are incorporated in a Manufacturer product or sold under a Manufacturer part or model number.

### Product Return and Repair

1. Return to Seller if Purchased Through an Authorized Dealer
  - a. Proof of purchase date from reseller within warranty period must be provided by the end user.
  - b. Seller may, at its discretion, provide an immediate exchange or repair or may return the unit to the Manufacturer for repair.
2. Return to Manufacturer
  - a. An RMA (return merchandise authorization) number must be issued to the end user from ClearOne technical support.
  - b. The end user must return the product to ClearOne with proof of purchase (showing purchase date) for a warranty claim, and display the RMA number on the outside of the shipping package.

### THIS WARRANTY IS VOID IF:

- A. The product has been damaged by negligence, accident, act of God, or mishandling, or has not been operated in accordance with the procedures described in the operating and technical instructions; or,
- B. The product has been altered or repaired by other than the Manufacturer or an authorized service representative of the Manufacturer; or,
- C. Adaptations or accessories other than those manufactured or provided by the Manufacturer have been made or attached to the product which, in the determination of the Manufacturer, shall have affected the performance, safety or reliability of the product; or,
- D. The product's original serial number has been modified or removed.

NO OTHER WARRANTY, EXPRESS OR IMPLIED, INCLUDING WARRANTIES OF MERCHANTABILITY OR FITNESS FOR ANY PARTICULAR USE, APPLIES TO THE PRODUCT. MANUFACTURER'S MAXIMUM LIABILITY HEREUNDER SHALL BE THE AMOUNT PAID BY THE END USER FOR THE PRODUCT. No person or entity authorized to assume any obligation or other liability in connection with the products. No action, regardless of form, arising out of or relating to the product or this warranty, may be brought by end user more than two (2) years after the cause of action has accrued.

Manufacturer shall not be liable for punitive, consequential, or incidental damages, expenses, or loss of revenue or property, inconvenience, or interruption in operation experienced by the end user due to a malfunction in the purchased product. No warranty service performed on any product shall extend the applicable warranty period.

In case of unsatisfactory operation, the end user shall promptly notify the Manufacturer at the address set forth below in writing, giving full particulars as to the defects or unsatisfactory operation. Upon receipt of such notice, the Manufacturer will give instructions respecting the shipment of the product, or such other matters as it elects to honor this warranty as above provided. This warranty does not cover damage to the product during shipping and the Manufacturer assumes no responsibility for such damage. All shipping costs shall be paid by the customer.

This warranty extends only to the original end user and is not assignable or transferable. This warranty is governed by the laws of the State of Utah, without regard to the conflicts of interests provisions thereof.

ClearOne Communications, Inc.  
1825 Research Way  
Salt Lake City, Utah 84119

## FCC Part 15/ICES-003 Compliance

This equipment has been tested and found to comply with the limits for a Class A digital device, pursuant to Part 15 of the FCC rules and Industry Canada ICES-003. These limits are designed to provide reasonable protection against harmful interference when the equipment is operated in a commercial environment. This equipment generates, uses, and can radiate radio frequency energy and, if not installed and used in accordance with the instruction manual, may cause harmful interference to radio communications. Operation of this equipment in a residential area is likely to cause harmful interference, in which case the user will be required to correct the interference at his/her own expense.

Operation is subject to the following two conditions: (1) This device may not cause interference, and (2) This device must accept any interference including interference that may cause undesired operation of the device.

Changes or modifications not expressly approved by ClearOne Communications could void the user's authority to operate the equipment.

## European Compliance

This equipment has been approved in accordance with Council Directive 1999/5/EC "Radio Equipment and Telecommunications Equipment". Compliance of the equipment with the Directive is attested by the application of the CE mark on the equipment.



## EC Declaration of Conformity

Application of Council Directive(s):	1999/5/EC Radio equipment and Telecommunications Terminal Equipment (R&TTE) Directive
Manufacturer's Name:	ClearOne Communications
Manufacturer's Address:	1825 West Research Way Salt Lake City, Utah 84119 U.S.A.
Model No.:	Ceiling DocCam II 910-171-066-PAL,

## Standard(s) to which Conformity is declared:

## 89/336/EEC "Electromagnetic Compatibility (EMC) Directive":

EN 55022: 1994 (Emissions)	Specification for limits and methods of measurement of radio interference characteristics of information technology equipment
EN 61000-3-2:1995/A1/A2:1998	Part 3: Limits - Section 2: Limits for harmonic current emissions.
EN 61000-3-3:1995	Section 3: Limitation of voltage fluctuations and flicker in low voltage supply systems for equipment with rated current up to and including 16 A
EN 55024: 1998 (Immunity)	Information technology equipment - Immunity characteristic. Limits and methods of measurement
EN 61000-4-2: 1995/A1:1998	Electrostatic Discharge
EN 61000-4-3: 1996/A1:1998	Radiated RF Immunity
EN 61000-4-4: 1995	Electrical Fast Transients
EN 61000-4-5: 1995	Lighting Surge
EN 61000-4-6: 1996	Conducted RF Immunity
EN 61000-4-11: 1994	Voltage Dips and Voltage Interruptions

## 73/23/EEC "Low Voltage Directive (LVD)":

IEC 60950-1: 2003	Safety of Information Technology Equipment, Including Electrical Business Equipment
-------------------	---

### Manufacturer

Signature

Roger J. Midgley

Full Name

Project Manager

Position

### Legal Representative in Europe

Signature

Martin Offwood

Full Name

Managing Director EMEA North

Position

## RS-232 control information

 **Note:** For best performance of the VISCA commands, set DIP switches to the ClearOne configuration when the camera is connected to the control port of a codec.

### Overview of VISCA

In VISCA a device that sends commands, such as a computer, is called the controller. The device that receives commands such as a camera is called the peripheral device. The parameters of RS-232C are as follows.

Communication speed: 9.6 kbps/19.2 kbps/38.4 kbps

- Data bits: 8
- Start bit: 1
- Stop: 1
- Non parity

Flow control using XON/XOFF and RTS/CTS, etc., is not supported.

### VISCA Communication Specifications

#### Command and inquiry

- **Command**  
Sends operational commands to the camera.
- **Inquiry**  
Used for inquiring about the current state of the camera.

	<b>Command Packet</b>	<b>Note</b>
Inquiry	81 QQ RR ... FF	QQ <sup>1)</sup> = Command/Inquiry RR <sup>2)</sup> = Category code

<sup>1)</sup>QQ = 01 (Command), 09 (Inquiry)

<sup>2)</sup>RR = (Interface), 04 (camera 1), 06 (Pan.Tilter), 07 (camera 2)

#### Responses for commands and inquiries

- **ACK Message**  
Returned by the camera when it receives a command. No ACK message is returned for inquiries.
- **Completion message**  
Returned by the camera when execution of commands or inquiries is completed. In the case of inquiry commands, it will contain reply data for the inquiry after the 3rd byte of the packet. If the ACK message is omitted, the socket number will contain 0.

	<b>Reply Packet</b>
Ack	90 41 FF
Completion (commands)	90 51 FF
Completion (inquiries)	90 51 FF

- **Error message**

When a command or inquiry command could not be executed or failed, an error message is returned instead of the completion message.

90 61 01 FF	Message length error (>14 bytes)
90 61 02 FF	Syntax Error
90 61 03 FF	Command buffer full
90 61 04 FF	Command Cancelled
90 61 05 FF	No socket (to be cancelled)
90 61 41 FF	Command not executable

#### Command execution cancel

To cancel a command which has already been sent, send the IF\_Clear command as the next command. To cancel one of any two commands which have been sent, use the cancel message.

	<b>Cancel Packet</b>
Cancel	81 21 FF

An error message will be returned for this command, but this is not a fault. It indicates that the command has been cancelled.

### VISCA Command/ ACK Protocol

Command	Command Message	Reply Message	Comments
General Command	81 01 04 38 02 FF (Example)	90 41 FF (ACK)+90 51 FF (Completion) 90 42 FF 90 52 FF	Returns ACK when a command has been accepted, and Completion when a command has been executed.
	81 01 04 38 FF (Example)	90 60 02 FF (Syntax Error)	Accepted a command which is not supported or a command lacking parameters.
	81 01 04 38 02 FF (Example)	90 60 03 FF (Command Buffer Full)	There are two commands currently being executed and the command could not be accepted.
	81 01 04 08 02 FF (Example)	90 61 41 FF (Command Not Executable) 90 62 41 FF	Could not execute the command in the current mode.
Inquiry Command	81 09 04 38 FF (Example)	90 50 02 FF (Completion)	ACK is not returned for the inquiry command.
	81 09 05 38 FF (Example)	90 60 02 FF (Syntax Error)	Accepted an incompatible command.
Address Set	88 03 01 FF	88 30 02 FF	Returned the device address to +1.
IF_Clear(Broadcast)	88 01 00 01 FF	88 01 00 01 FF	Returned the same command.
IF_Clear (for x)	81 01 00 01 FF	z0 50 FF (Completion)	ACK is not returned for this command.
Command Cancel	81 21 FF	z0 61 04 FF (Command Canceled)	Returned when the command of the socket specified is cancelled. Completion for the command cancelled is not returned.
		z0 61 05 FF	Returned when the command of the specified socket has already been completed or when the socket number specified is wrong.

## VISCA Camera-Issued Messages

### ACK/Completion Messages

	Command Messages	Comments
ACK	z0 4y FF (y:Socket No.)	Returned when the command is accepted.
Completion	z0 5y FF (y: Socket No.)	Returned when the command has been executed.

z=Device address +8

### Error Messages

	Command Messages	Comments
Syntax Error	90 60 02 FF	Returned when the command format is different or when a command with illegal command parameters is accepted.
Command Buffer Full	90 60 03 FF	Indicates that two sockets are already being used (executing two commands) and the command could not be accepted when received.
Command Cancelled	90 6y 04 FF (1:Socket No.)	Returned when a command which is being executed in a socket specified by the cancel command is canceled. The completion message for command is not returned.
No Socket	90 6y 05 FF (1:Socket No.)	Returned when no command is executed in a socket specified by the cancel command, or when an invalid socket number is specified.
Command not executable	90 6y 41 FF (1:Socket No.)	Returned when a command cannot be executed due to current conditions. For example, when commands controlling the focus manually are received during auto focus.

### Network Change Message

	Command Message	Comments
Network Change	z0 38 FF	Issued when power is being routed.

## Command List

Command Set	Command	Command Packet	Comments
Camera Power	On	81 01 08 01 01 FF	Power on
	Off	81 01 08 01 00 FF	Power off
Laser Power	On	81 01 08 02 01 FF	Power on
	Off	81 01 08 02 00 FF	Power off
	Momentary	81 01 08 02 02 XX FF	XX=time on from 1 to 10 seconds
Address Set	Broadcast	88 30 01 FF	
IF_Clear	Broadcast	88 01 00 01 FF	
CommandCancel		81 2p FF	p: Socket No.(=1or2)
CAM_Zoom	Stop	81 01 04 07 00 FF	
	Tele (Standard)	81 01 04 07 02 FF	
	Wide (Standard)	81 01 04 07 03 FF	
	Tele (Variable)	81 01 04 07 2p FF	p=0 (Low) to 7 (high)
	Wide (Variable)	81 01 04 07 3p FF	
	Direct	81 01 04 47 0p 0q 0r 0s FF	pqrs: Zoom Position
CAM_DZoom	On	81 01 04 06 02 FF	Digital zoom ON/OFF
	Off	81 01 04 06 03 FF	
	Combine Mode	81 01 04 36 00 FF	Optical/Digital Zoom Combined
	Separate Mode	81 01 04 36 01 FF	Optical/Digital Zoom Separate
	Stop	81 01 04 06 00 FF	
	Tele(Variable)	81 01 04 06 2p FF	p=0 (low) to 7 (high)
	Wide(Variable)	81 01 04 06 3p FF	
	x1/Max	81 01 04 06 10 FF	x1/Max Magnification Switchover
	Direct	81 01 04 46 00 00 0p 0q FF	pq: D-Zoom Position
	CAM_Focus	Stop	81 01 04 08 00 FF
Far (Standard)		81 01 04 08 02 FF	
Near (Standard)		81 01 04 08 03 FF	
Far (Variable)		81 01 04 08 2p FF	p=0 (Low) to 7 (high)
Near (Variable)		81 01 04 08 3p FF	
Direct		81 01 04 48 0p 0q 0r 0s FF	pqrs: Focus Position
Auto Focus		81 01 04 38 02 FF	AF ON/OFF
Manual Focus		81 01 04 38 03 FF	
Auto/Manual		81 01 04 38 10 FF	
One Push Trigger		81 01 04 18 01 FF	One Push AF Trigger
Infinity		81 01 04 18 02 FF	Forced infinity
Near Limit		81 01 04 28 0p 0q 0r 0s FF	pqrs: Focus Near Limit Position
AF Sensitivity		Normal	81 01 04 58 02 FF
	Low	81 01 04 58 03 FF	

Command Set	Command	Command Packet	Comments
CAM_AF Mode	Normal AF	81 01 04 57 00 FF	AF Movement Mode
	Interval AF	81 01 04 57 01 FF	
	Zoom Trigger AF	81 01 04 57 02 FF	
	Active/Interval Time	81 01 04 27 0p 0q 0r 0s FF	pq: Movement Time rs: Interval
CAM_ZoomFocus	Direct	81 01 04 47 0p 0q 0r 0s 0t 0u 0v 0w FF	pqrs: Zoom Position tuvw: Focus Position
CAM_Initialize	Lens	81 01 04 19 01 FF	Lens Initialization Start
	Comp Scan	81 01 04 19 02 FF	Correction of CCD pixel blemishes
CAM_WB	Auto	81 01 04 35 00 FF	Normal Auto
	Indoor	81 01 04 35 01 FF	Indoor Mode
	Outdoor	81 01 04 35 02 FF	Outdoor Mode
	One Push WB	81 01 04 35 03 FF	One Push WB Mode
	ATW	81 01 04 35 04 FF	Auto Tracing White Balance
	Manual	81 01 04 35 05 FF	Manual Control mode
CAM_RGain	Reset	81 01 04 03 00 FF	Manual Control of R Gain
	Up	81 01 04 03 02 FF	
	Down	81 01 04 03 03 FF	
	Direct	81 01 04 43 00 00 0p 0q FF	pq: R Gain
CAM_BGain	Reset	81 01 04 04 00 FF	Manual Control of B Gain
	Up	81 01 04 04 02 FF	
	Down	81 01 04 04 03 FF	
	Direct	81 01 04 44 00 00 0p 0q FF	pq: B Gain
CAM_AE	Full Auto	81 01 04 39 00 FF	Automatic Exposure Mode
	Manual	81 01 04 039 03 FF	Manual Control Mode
	Shutter Priority	81 01 04 39 0A FF	Shutter Priority Automatic Exposure mode
	Iris Priority	81 01 04 39 0B FF	Iris priority Automatic Exposure mode
	Bright	81 01 04 039 0D FF	Bright mode (Manual Control)
CAM_SlowShutter	Auto	81 01 04 5A 02 FF	Auto Slow Shutter On/Off <sup>a)</sup>
	Manual	81 01 04 5A 03 FF	
CAM_Shutter	Reset	81 01 04 0A 00 FF	Shutter Setting <sup>a)</sup>
	Up	81 01 04 0A 02 FF	
	Down	81 01 04 0A 03 FF	
	Direct	81 01 04 4A 00 00 0p 0q FF	pq: Shutter Position
CAM_Iris	Reset	81 01 04 0B 00 FF	Iris Setting
	Up	81 01 04 0B 02 FF	
	Down	81 01 04 0B 03 FF	
	Direct	81 01 04 4B 00 00 0p 0q FF	pq: Iris Position

a) Some models do not support slow shutter.

Command Set	Command	Command Packet	Comments
CAM_Gain	Reset	81 01 04 0C 00 FF	Gain Setting
	Up	81 01 04 0C 02 FF	
	Down	81 01 04 0C 03 FF	
	Direct	81 01 04 4C 00 00 0p 0q FF	pq: Gain Position
CAM_Bright	Reset	81 01 04 0D 00 FF	Bright Setting
	Up	81 01 04 0D 02 FF	
	Down	81 01 04 0D 03 FF	
CAM_ExpComp	On	81 01 04 3E 02 FF	Exposure Compensation ON/OFF
	Off	81 01 04 3E 03 FF	
	Reset	81 01 04 0E 00 FF	Exposure Compensation Amount Setting
	Up	81 01 04 0E 02 FF	
	Down	81 01 04 0E 03 FF	
	Direct	81 01 04 4E 00 00 0p 0q FF	pq: ExpComp Position
CAM_BackLight	On	81 01 04 33 02 FF	Back Light Compensation On/Off
	Off	81 01 04 33 03 FF	
CAM_SpotAE	On	81 01 04 59 02 FF	
	Off	81 01 04 59 03 FF	
	Position	81 01 04 29 0p 0q 0r 0s FF	
CAM_Aperture	Reset	81 01 04 02 00FF	Aperture Control
	Up	81 01 04 02 02 FF	
	Down	81 01 04 02 03 FF	
	Direct	81 01 04 42 00 00 0p 0q FF	pq: Aperture Gain
CAM_LR_Reverse	On	81 01 04 61 02 FF	Mirror Image On/Off
	Off	81 01 04 61 03 FF	
CAM_Freeze	On	81 01 04 62 02 FF	Still Image On/Off
	Off	81 01 04 62 03 FF	
CAM_PictureEffect	Off	81 01 04 63 00 FF	Picture Effect Setting
	Neg. Art	81 01 04 63 02 FF	
	B&W	81 01 04 63 04 FF	
CAM_PictureFlip	On	81 01 04 66 02 FF	Picture Flip On/Off
	Off	81 01 04 66 03 FF	
CAM_ICR	On	81 01 04 01 02 FF	Infared Mode On/Off
	Off	81 01 04 01 03 FF	
CAM_Auto ICR	On	81 01 04 51 02 FF	Auto Infared Mode On/Off
	Off	81 01 04 51 03 FF	

Command Set	Command	Command Packet	Comments
CAM_Stablizer	On	81 01 04 34 02 FF	Vibration Correction On/Off
	Off	81 01 04 34 03 FF	
CAM_Memory	Reset	81 01 04 3F 00 0p FF	p: Memory Number (=0 to 5)
	Set	81 01 04 3F 01 0p FF	
	Recall	81 01 03 3F 01 0p FF	
CAM_Custom	Reset	81 01 04 3F 00 7F FF	Starts in this mode at Power on
	Set	81 01 04 3F 01 7F FF	
	Recall	81 01 04 3F 02 7F FF	
CAM_Display	On	81 01 04 15 02 FF (81 01 06 06 02 FF)	Display On/Off
	Off	81 01 04 15 03 FF (81 01 06 06 03 FF)	
	On/Off	81 01 04 15 10 FF (81 01 04 06 06 10 FF)	
CAM_Title	Title Set 1	81 01 04 73 00 mm nn pp qq 00 00 00 00 00 00 FF	mm: Vposition, nn: Hposition, pp: Color qq: Blink
	Title Set 2	81 01 04 73 01 mm nn pp qq rr ss tt uu vv ww FF	mnpqrstuuv: Setting of Display Characters 1st to 10th Character
	Title Set 3	81 01 04 73 02 mm nn pp qq rr ss tt uu vv ww FF	mnpqrstuuv: Setting of Display Characters 11st to 20 th Character
	Title Clear	81 01 04 74 00FF	Title Setting Clear
	On	81 01 04 74 02 FF	Title Display On/Off
CAM_Mute	Off	81 01 04 74 03 FF	Mute On/Off
	On	81 01 04 75 02 FF	
	Off	81 01 04 75 03 FF	
	ON/Off	81 01 04 75 10 FF	
CAM_VPhase	Stop	81 01 04 05 00 FF	
	Up	81 01 04 05 02 FF	
	Down	81 01 04 05 03 FF	
	Up (Step)	81 01 04 08 2p FF	p=step (1-7)
	Down (Step)	81 01 04 05 3p FF	
	Reset	81 01 04 05 40 FF	Restore factory settings
	Direct	81 01 04 45 00 00 0p 0q FF	pq: V-Phase (00-FF)
	0 degree	81 01 04 25 00 FF	No Phase Turnover
180 degree	81 01 04 25 01 FF	Phase Turnover	

Command Set	Command	Command Packet	Comments
CAM_PrivacyZone	SetMask	81 01 04 76 mm nn 0p 0p 0q 0q 0r 0r 0s 0s FF	mm: Mask Settings nn 00: Modify, 01: New pp: X, qq: Y, rr: W, ss: H
	Display	81 01 04 77 pp pp pp pp FF	Mask Display On/Off pp pp pp pp : Mask Settings (0: Off, 1: On)
	SetMask Color	81 01 04 78 pp pp pp pp qq rr FF	pp pp pp pp: Mask Color Settings qq: Color Setting when 0 is selected rr: Color SETting when 1 is selected
	SetPan TiltAngle	81 01 04 79 0p 0p 0p 0q 0q 0q FF	Pan/Tilt Angle Settings ppp: Pan qqq: Tilt
	Move Pan Tilt	81 01 04 7A 0p 0p 0q 0q rs FF	pp: Pan Speed qq: Tilt Speed r 0: Stop, 1: Right, 2: Left s 0: Stop, 1: Up, 2: Down
	Set PTzMask	81 01 04 7B mm 0p 0p 0p 0q 0q 0q 0r 0r 0r FF	Pan/Tilt/Zoom Settings for Mask ppp:Pan, qq: tilt rrr: zoom
	GridOn	81 01 04 7C 02 FF	Grid Display On/Off
	GridOff	81 01 04 7C 03 FF	
CAM_KeyLock	Off	81 01 04 17 00 FF	Camera Control Enable/Disbale
	On	81 01 04 17 02 FF	
CAM_IDWrite		81 01 04 22 0p 0q 0r 0s FF	pqrs: Camera ID (=0000 to FFFF)
CAM_ExternalLock	INT	81 01 04 55 00 FF	Internal Mode
	Line Lock	81 01 04 55 01 FF	Line Lock mode
CAM_Alarm	On	81 01 04 6B 02 FF	Alarm On/Off
	Off	81 01 04 6B 03 FF	
	SetMode	81 01 04 6C pp FF	PP: Mode Settings 00 Focus Move Detection (The rest position is fixed.) 01 Focus Move Detection (The rest position is reset.) 02 AE Move Detection (The rest value is fixed.) 01 AE Move Detection (The rest value is reset.)
	SetTime	81 01 04 6D 0p 0p FF	pp: Reset Time Setting
	Alarm (Reply)	90 07 04 6B 01 FF	Detect Level "Low" to "High"
		90 07 04 6B 00 FF	Detect Level "High" to "Low"
CAM_ExternalLock	INT	81 01 04 55 00 FF	
	LIne Lock	81 01 04 55 01 FF	

## Inquiry Command

Inquiry Command	Command Packet	Inquiry Packet	Comments
Camera Power	81 09 08 01 FF	90 50 00 FF	Off
		90 50 01 FF	On
Laser Power	81 09 08 02 FF	90 50 00 FF	Off
		90 50 01 FF	On
		90 50 02 XX FF	On Momentary with XX s left
CAM_PowerInq	81 09 04 00 FF	90 50 02 FF	On
		90 50 03 FF	Off
CAM_ZoomPosInq	81 09 04 47 FF	90 50 0p 0q 0r 0s FF	pqrs: Zoom Position
CAM_DZoomModInq	81 09 04 06 FF	90 50 02 FF	D-Zoom on
		90 50 03 FF	D-Zoom Off
CAM_DZoomC/SModInq	81 09 04 36 FF	90 50 00 FF	Combine Mode
		90 50 01 FF	Separate Mode
CAM_DZoomPosInq	81 09 04 46 FF	90 50 00 00 0p 0q FF	pq: D-Zoom Position
CAM_FocusModeInq	81 09 04 38 FF	90 50 02 FF	Auto Focus
		90 50 03 FF	Manual Focus
CAM_FocusPosInq	81 09 04 48 FF	90 50 0p 0q 0r 0s FF	pqrs: Focus Position
CAM_FocusNearLimitInq	81 09 04 28 FF	90 50 0p 0q 0r 0s FF	pqrs: Focus Near Limit Position
CAM_AFSensitivityInq	81 09 04 58 FF	90 50 02 FF	AF Sensitivity Normal
		90 50 03 FF	AF Sensitivity Low
CAM_AFModInq	81 09 04 57 FF	90 50 00 FF	Normal AF
		90 50 01 FF	Interval AF
		90 50 02 FF	Zoom Trigger AF
CAM_AFTimeSettingInq	81 09 04 27 FF	90 50 0p 0q 0r 0s FF	pq: Movement Time rs: Interval
CAM_WBModeInq	81 09 04 35 FF	90 50 00 FF	Auto
		90 50 01 FF	In Door
		90 50 02 FF	Out Door
		90 50 03 FF	One Push WB
		90 50 04 FF	ATW
CAM_RGainInq	81 09 04 43 FF	90 50 00 00 0p 0q FF	pq: R Gain
		90 50 01 00 0p 0q FF	pq: B Gain
		90 50 02 00 0p 0q FF	pq: G Gain
		90 50 03 00 0p 0q FF	pq: Blue Gain
Cam AEModeInq	81 09 04 39 FF	90 50 00 FF	Full Auto
		90 50 03 FF	Manual
		90 50 0A FF	Shutter Priority
		90 50 0B FF	Iris Priority
		90 50 0D FF	Bright
CAM_SlowShutterModeInq	81 09 04 5A FF	90 50 02 FF	Auto
		90 50 03 FF	Manual
CAM_ShutterPosInq	81 09 04 4A FF	90 50 00 00 0p 0q FF	pq: Shutter Position
CAM_IrisPosInq	81 09 04 4B FF	90 50 00 00 0p 0q FF	pq: Iris Position
CAM_GainPosInq	81 09 04 4C FF	90 50 00 00 0p 0q FF	pq: Gain Position
CAM_BrightPosInq	81 09 04 4D FF	90 50 00 00 0p 0q FF	pq: Bright Position
CAM_ExpCompModInq	81 09 04 3E FF	90 50 02 FF	On
		90 50 03 FF	Off
CAM_ExpComPosInq	81 09 04 4E FF	90 50 00 00 0p 0q FF	pq: ExpCom Position
CAM_BacklightModeInq	81 09 04 33 FF	90 50 02 FF	On
		90 50 03 FF	Off

Inquiry Command	Command Packet	Inquiry Packet	Comments
CAM_SpotAE PosInq	81 09 04 29 FF	90 50 0p 0q 0r 0s FF	pq: X position rs: Y position
CAM_ApertureInq	81 09 04 42 FF	90 50 00 00 0p 0q FF	pq: Aperture Gain
CAM_LR_Reverse ModeInq	81 09 04 61 FF	90 50 02 FF	On
		90 50 03 FF	Off
CAM_FreezeModeInq	81 09 04 62 FF	90 50 02 FF	On
		90 50 03 FF	Off
CAM_PictureEffectModeInq	81 09 04 63 FF	90 50 00 FF	Off
		90 50 02 FF	Neg.Art
		90 50 04 FF	B&W
CAM_PictureFlipModeInq	81 09 04 66 FF	90 50 02 FF	On
		90 50 03 FF	Off
CAM_ICRModeInq	81 09 04 01 FF	90 50 02 FF	On
		90 50 03 FF	Off
CAM_AutoICRModeInq	81 09 04 51 FF	90 50 02 FF	On
		90 50 03 FF	Off
CAM_StabilizerModeInq	81 09 04 34 FF	90 50 02 FF	On
		90 50 03 FF	Off
CAM_MemoryInq	81 09 04 3F FF	90 50 pp FF	pp: Last Recall Memory No.
CAM_DisplayModeInq	81 09 04 15 FF (81 09 06 06 FF)	90 50 02 FF	On
		90 50 03 FF	Off
CAM_TitleDisplayModeInq	81 09 04 74 FF	90 50 02 FF	On
		90 50 03 FF	Off
CAM_MuteModeInq	81 09 04 75 FF	90 50 02 FF	On
		90 50 03 FF	Off
CAM_PrivacyDisplayInq	81 09 04 77 FF	90 50 pp pp pp pp FF	pp pp pp pp : Mask Settings (0:Off, 1: On)
CAM_PrivacyPanTiltInq	81 09 04 79 FF	90 50 0p 0p 0p 0q 0q 0q FF	ppp: Pan qqq: Tilt
CAM_PrivacyPTZInq	81 09 04 7B mm FF	90 50 0p 0p 0p 0q 0q 0q 0r 0r 0r FF	mmm: Mask Settings ppp: Pan qqq: Tilt rrr: Zoom
CAM_KeyLockInq	81 09 04 17 FF	90 50 00 FF	Off
		90 50 02 FF	On
CAM_IDInq	81 09 04 22 FF	90 50 0p 0q 0r 0s FF	pqrs: Camera ID
CAM_ExternalLockModeInq	81 09 04 55 FF	90 50 00 FF	Internal Mode
		90 50 01 FF	Line Lock Mode
CAM_VPhaseSetInq	81 09 04 25 FF	90 50 00 FF	0 degree
		90 50 01 FF	180 degree
CAM_VPhasePosInq	81 09 04 45 FF	90 50 00 00 0p 0q FF	pq: V-Phase Position
CAM_VersionInq	81 09 00 02 FF	90 50 00 20 mn pq rs tu vw FF	mnpq: Model Code(04xx) rstu: ROM Version vw: Socket Number (=02)
CAM_AlarmInq	81 09 04 6B FF	90 50 02 FF	On
		90 50 03 FF	Off
CAM_AlarmModeInq	81 09 04 6C FF	90 50 pp FF	pp: Alarm Mode
CAM_AlarmTimeInq	81 09 04 6D FF	90 50 0p 0p FF	pp: Rest Position/ Value Reset Time
CAM_AlarmDetectLevelInq	81 09 04 6E FF	90 50 01 FF	Detect Level "High"
		90 50 00 FF	Detect Level "Low"
CAM_SpotAEModeInq	81 09 04 59 FF	90 50 02 FF	On
		90 50 03 FF	Off



## Block Inquiry Command List

Lens Control System Inquiry Commands ... Command Packet 8x 09 7E 7E 00 FF

Byte	Bit	Comments
0	7	Destination Address
	6	
	5	
	4	
	3	Source Address
	2	
	1	
0		
1	7	0 Completion Message (50h)
	6	1
	5	0
	4	1
	3	0
	2	0
	1	0
	0	0
2	7	0
	6	0
	5	0
	4	0
	3	Zoom Position (HH)
	2	
	1	
0		
3	7	0
	6	0
	5	0
	4	0
	3	Zoom Position (HL)
	2	
	1	
	0	

Byte	Bit	Comments
4	7	0
	6	0
	5	0
	4	0
	3	Zoom Position (LH)
	2	
	1	
0		
5	7	0
	6	0
	5	0
	4	0
	3	Zoom Position (LL)
	2	
	1	
	0	

6	7	0
	6	0
	5	0
	4	0
	3	Focus NearLimit (H)
	2	
	1	
0		

7	7	0
	6	0
	5	0
	4	0
	3	Focus Near Limit (L)
	2	
	1	
	0	

Byte	Bit	Comments
8	7	0
	6	0
	5	0
	4	0
	3	Focus Position (HH)
	2	
	1	
	0	

9	7	0
	6	0
	5	0
	4	0
	3	Focus Position (HL)
	2	
	1	
0		

10	7	0
	6	0
	5	0
	4	0
	3	Focus Position (LH)
	2	
	1	
0		

11	7	0
	6	0
	5	0
	4	0
	3	Focus Position (LL)
	2	
	1	
	0	

Byte	Bit	Comments
12	7	0
	6	0
	5	0
	4	0
	3	0
	2	0
	1	0
	0	0
13	7	0
	6	0
	5	DZoomMode 1: Separate 0:Combine
	4	0: Normal 0: Interval 1: Zoom Trigger 0: 1:
	3	AF Sensitivity 1: Normal 0: Slow
	2	Digital Zoom Mode 1: On 0: Off
	1	Focus Mode 1: Auto 0: Manual
	0	
14	7	0
	6	0
	5	0
	4	0
	3	Low Contrast Detection 1: Yes 0: No
	2	Camera Memory Recall 1: Executing 0: Stopped
	1	Focus Command 1: Executing 0: Stopped
0	Zoom Command 1: Executing 0: Stopped	
15	7	1 Terminator (FFh)
	6	1
	5	1
	4	1
	3	1
	2	1
	1	1
	0	1

## Camera Control System Inquiry Commands ... Command Packet 8x 09 7E 7E 01 FF

Byte	Bit	Comments
0	7	Destination Address
	6	
	5	
	4	
	3	Source Address
	2	
	1	
0	0 Completion Message (50h)	
1	7	0
	6	1
	5	0
	4	1
	3	0
	2	0
	1	0
	0	0
2	7	0
	6	0
	5	0
	4	0
	3	R Gain (H)
	2	
	1	
0		
3	7	0
	6	Stabilizer (1:on, 0: off)
	5	0
	4	0
	3	R Gain (L)
	2	
	1	
0		

Byte	Bit	Comments
4	7	0
	6	0
	5	0
	4	0
	3	B Gain (H)
	2	
	1	
0		
5	7	0
	6	0
	5	0
	4	0
	3	B Gain (L)
	2	
	1	
0		
6	7	0
	6	0
	5	0
	4	0
	3	0
	2	WB Mode
	1	
0	0	
7	7	0
	6	0
	5	0
	4	0
	3	Aperture Gain
	2	
	1	
0		

Byte	Bit	Comments
8	7	0
	6	0
	5	0
	4	0
	3	Focus Position (HH)
	2	
	1	
	0	
0		
9	7	0
	6	0
	5	0
	4	0
	3	Focus Position (HL)
	2	
	1	
	0	
0		
10	7	0
	6	0
	5	0
	4	0
	3	Focus Position (LH)
	2	
	1	
	0	
0		
11	7	0
	6	0
	5	0
	4	0
	3	Focus Position (LL)
	2	
	1	
	0	
0		

Byte	Bit	Comments
12	7	0
	6	0
	5	0
	4	0
	3	0
	2	0
	1	0
	0	0
13	7	0
	6	0
	5	DZoomMode 1: Separate 0: Combine
	4	0: Normal 0: Interval 1: Zoom Trigger
	3	AF Sensitivity 1: Normal 0: Slow
	2	Digital Zoom Mode 1: On 0: Off
	1	Focus Mode 1: Auto 0: Manual
	0	0
14	7	0
	6	0
	5	0
	4	0
	3	Low Contrast Detection 1: Yes 0: No
	2	
	1	Focus Command 1: Executing 0: Stopped
	0	Zoom Command 1: Executing 0: Stopped
15	7	1 Terminator (FFh)
	6	1
	5	1
	4	1
	3	1
	2	1
	1	1
	0	1

## Other Inquiry Commands ... Command Packet 8x 09 7E 7E 02 FF

Byte	Bit	Comments
0	7	Destination Address
	6	
	5	
	4	
	3	Source Address
	2	
	1	
0	0 Completion Message (50h)	
1	7	0
	6	1
	5	0
	4	1
	3	0
	2	0
	1	0
	0	0
2	7	0
	6	0
	5	0
	4	0
	3	R Gain (H)
	2	
	1	
0		
3	7	0
	6	Stabilizer (1:on, 0: off)
	5	0
	4	0
	3	R Gain (L)
	2	
1		
0		

Byte	Bit	Comments
4	7	0
	6	0
	5	0
	4	0
	3	B Gain (H)
	2	
	1	
0		
5	7	0
	6	0
	5	0
	4	0
	3	B Gain (L)
	2	
	1	
0		
6	7	0
	6	0
	5	0
	4	0
	3	0
	2	WB Mode
	1	
0		
7	7	0
	6	0
	5	0
	4	0
	3	Aperture Gain
	2	
	1	
0		

Byte	Bit	Comments
8	7	0
	6	0
	5	0
	4	Exposure Mode
	3	
	2	
	1	
0		
9	7	0
	6	0
	5	0
	4	0
	3	Spot AE 1: On 0: Off
	2	Back Light 1: On 0: Off
	1	Exposure Comp. 1: On 0: Off
0	Slow Shutter 1: Auto 2: Manual	
10	7	0
	6	0
	5	0
	4	Shutter Position
	3	
	2	
	1	
0		
11	7	0
	6	0
	5	0
	4	Iris Position
	3	
	2	
	1	
0		

Byte	Bit	Comments
12	7	0
	6	0
	5	0
	4	0
	3	Gain Position
	2	
	1	
0		
13	7	0
	6	0
	5	0
	4	Bright Position
	3	
	2	
	1	
0		
14	7	0
	6	0
	5	0
	4	0
	3	Exposure Comp. Position
	2	
	1	
0		
15	7	1 Terminator (FFh)
	6	1
	5	1
	4	1
	3	1
	2	1
	1	1
0	1	

## Enlargement Function Query Command ... Command Packet 8x 09 7E 7E 03 FF

Byte	Bit	Comments
0	7	Destination Address
	6	
	5	
	4	
	3	Source Address
	2	
	1	
	0	
1	7	0 Completion Message (50h)
	6	1
	5	0
	4	1
	3	0
	2	0
	1	0
	0	0
2	7	0
	6	0
	5	0
	4	0
	3	Digital Zoom Position (H)
	2	
	1	
	0	
3	7	0
	6	0
	5	0
	4	0
	3	Digital Zoom Position (L)
	2	
	1	
	0	

Byte	Bit	Comments
4	7	0
	6	0
	5	0
	4	0
	3	AF Activation Time (H)
	2	
	1	
	0	
5	7	0
	6	0
	5	0
	4	0
	3	AF Activation Time (L)
	2	
	1	
	0	
6	7	0
	6	0
	5	0
	4	0
	3	AF Interval Time (H)
	2	
	1	
	0	
7	7	0
	6	0
	5	0
	4	0
	3	AF Interval Time (L)
	2	
	1	
	0	

Byte	Bit	Comments
8	7	0
	6	0
	5	0
	4	0
	3	SpotAE Position (X)
	2	
	1	
	0	
9	7	0
	6	0
	5	0
	4	0
	3	Spot AE Position (Y)
	2	
	1	
	0	
10	7	0
	6	0
	5	0
	4	0
	3	0
	2	0
	1	Alarm (1:on, 0: Off)
	0	Picture Flip (1:On, 0: Off)
11	7	0
	6	0
	5	0
	4	0
	3	0
	2	Advanced Privacy (1: Provided 0: Not Provided)
	1	Alarm (1: Provided 0: Not Provided)
	0	Picture Flip (1:Provided, 0: Not Provided)

Byte	Bit	Comments
12	7	0
	6	0
	5	0
	4	0
	3	0
	2	0
	1	0
	0	0
13	7	0
	6	0
	5	0
	4	0
	3	0
	2	0
	1	0
	0	0
14	7	0
	6	0
	5	0
	4	0
	3	0
	2	0
	1	0
	0	0
15	7	1 Terminator (FFh)
	6	1
	5	1
	4	1
	3	1
	2	1
	1	1
	0	1

## VISCA Command Setting Values

### Exposure control

Shutter Speed	NTSC		PAL	
	15	10000	10000	10000
	14	6000	6000	6000
	13	4000	3500	3500
	12	3000	2500	2500
	11	2000	1750	1750
	10	1500	1250	1250
	0F	1000	1000	1000
	0E	725	600	600
	0D	500	425	425
	0C	350	300	300
	0B	250	215	215
	0A	180	150	150
	09	125	120	120
	08	100	100	100
	07	90	75	75
	06	60	50	50
	05	30	25	25
	04	15	12	12
	03	8	6	6
	02	4	3	3
	01	2	2	2
	00	1	1	1

Gain	Gain	
	Code	Gain
	0F	28 dB
	0E	26 dB
	0D	24 dB
	0C	22 dB
	0B	20 dB
	0A	18 dB
	09	16 dB
	08	14 dB
	07	12 dB
	06	10 dB
	05	8 dB
	04	6 dB
	03	4 dB
	02	+2 dB
	01	0
	00	-3 dB

Iris	Iris	
	Code	Iris
	11	F1.6
	10	F2
	0F	F2.4
	0E	F2.8
	0D	F3.4
	0C	F4
	0B	F4.8
	0A	F5.6
	09	F6.8
	08	F8
	07	F9.6
	06	F11
	05	F14
	04	F16
	03	F19
	02	F22
	01	F28
	00	CLOSE

### Exposure control

Bright	IRIS		GAIN	
	Code	IRIS	Code	GAIN
	1F	F1.6	28 dB	
	1E	F1.6	26 dB	
	1D	F1.6	24 dB	
	1C	F1.6	22 dB	
	1B	F1.6	20 dB	
	1A	F1.6	18 dB	
	19	F1.6	16 dB	
	18	F1.6	14 dB	
	17	F1.6	12 dB	
	16	F1.6	10 dB	
	15	F1.6	8 dB	
	14	F1.6	6 dB	
	13	F1.6	4 dB	
	12	F1.6	2 dB	
	11	F1.6	0	
	10	F2	0	
	0F	F2.4	0	
	0E	F2.8	0	
	0D	F3.4	0	
	0C	F4	0	
	0B	F4.8	0	
	0A	F5.6	0	
	09	F6.8	0	
	08	F8	0	
	07	F9.6	0	
	06	F11	0	
	05	F14	0	
	04	F16	0	
	03	F19	0	
	02	F22	0	
	01	F28	0	
	00	CLOSE	0	

Exposure Comp.	IRIS GAIN		
	Code	IRIS	GAIN
	0E	7	10.5 dB
	0D	6	9 dB
	0C	5	7.5 dB
	0B	4	6 dB
	0A	3	4.5 dB
	09	2	3 dB
	08	1	1.5 dB
	07	0	0 dB
	06	-1	-1.5 dB
	05	-2	-3 dB
	04	-3	-4.5 dB
	03	-4	-6 dB
	02	-5	-7.5 dB
	01	-6	-9 dB
	00	-7	10.5 dB

## Zoom Ratio and Zoom Position (for reference)

Zoom Ratio x25 Lens	Optical Zoom Position Data	x25-NTSC		x25-PAL	
		Digital Zoom Ratio	Digital Zoom Position Data	Digital Zoom Position Data	Digital Zoom Position Data
x1	0000	x1	4000	4000	
x2	1781	x2	5E00	5E80	
x3	213B	x3	6800	6880	
x4	2752	x4	6D00	6DC0	
x5	2BB3	x5	7000	70C0	
x6	2F03	x6	7200	72C0	
x7	315D	x7	7380	7440	
x8	3364	x8	7480	7540	
x9	34FF	x9	7580	7600	
x10	362C	x10	7600	76C0	
x11	373D	x11	76C0	7740	
x12	386A	x12	7700	77C0	
x13	3929				
x14	3A20				
x15	3AfA				
x16	3BBA				
x17	3C5E				
x18	3CCB				
x19	3D70				
x20	3DF8				
x21	3E66				
x22	3Ed3				
x23	3F25				
x24	3F93				
x25	4000				

## Lens Control

Zoom Position	0000 to 4000 to 7700 (77C0) a)		
	Wide End	Optical Tele End	Digital Tele End
Focus Position	1000 to C000		
	Far End	Near End	
Focus Near Limit	1000: Over Inf 2000: 7.2 m 3000: 3.3 m 4000: 2.0 m 5000: 1.3 m 6000: 1 m 7000: 80 cm 8000: 40 cm 9000: 20 cm A000: 11 cm B000: 6 cm C000: 3.5 cm	As the distance on the left will differ dur to temperature characteristics, etc., use as approximate vaules. * The lower 1 byte is fixed at 00.	

a) PAL

## Others

R,B gain	00~FF
Aperture	00~0F

## Title Setting

Vposition	00 to 0A	
Hposition	00 to 17	
Blink	00: Does not blink	
	01: Blinks	
Color	00	White
	01	Yellow
	02	Violet
	03	Red
	04	Cyan
	05	Green
	06	Blue

## Free Manuals Download Website

<http://myh66.com>

<http://usermanuals.us>

<http://www.somanuals.com>

<http://www.4manuals.cc>

<http://www.manual-lib.com>

<http://www.404manual.com>

<http://www.luxmanual.com>

<http://aubethermostatmanual.com>

Golf course search by state

<http://golfingnear.com>

Email search by domain

<http://emailbydomain.com>

Auto manuals search

<http://auto.somanuals.com>

TV manuals search

<http://tv.somanuals.com>