



SpectraLink 6300 MCU

Installation

SpectraLink 6000 System

November 2009 Edition
1725-36122-001
Version M



Patent Information

The accompanying product is protected by one or more US and foreign patents and/or pending patent applications held by Polycom, Inc.

Copyright Notice

© 1998 to 2009, Polycom, Inc. All rights reserved. POLYCOM®, the Polycom "Triangles" logo and the names and marks associated with Polycom's products are trademarks and/or service marks of Polycom, Inc. and are registered and/or common law marks in the United States and various other countries. All other trademarks are property of their respective owners. No portion hereof may be reproduced or transmitted in any form or by any means, for any purpose other than the recipient's personal use, without the express written permission of Polycom.

All rights reserved under the International and pan-American copyright Conventions.

No part of this manual, or the software described herein, may be reproduced or transmitted in any form or by any means, or translated into another language or format, in whole or in part, without the express written permission of Polycom, Inc.

Do not remove (or allow any third party to remove) any product identification, copyright or other notices.

Every effort has been made to ensure that the information in this document is accurate. Polycom, Inc. is not responsible for printing or clerical errors. Information in this document is subject to change without notice and does not represent a commitment on the part of Polycom, Inc.

Notice

Polycom, Inc. has prepared this document for use by Polycom personnel and customers. The drawings and specifications contained herein are the property of Polycom and shall be neither reproduced in whole or in part without the prior written approval of Polycom, nor be implied to grant any license to make, use, or sell equipment manufactured in accordance herewith.

Polycom reserves the right to make changes in specifications and other information contained in this document without prior notice, and the reader should in all cases consult Polycom to determine whether any such changes have been made.

NO REPRESENTATION OR OTHER AFFIRMATION OF FACT CONTAINED IN THIS DOCUMENT INCLUDING BUT NOT LIMITED TO STATEMENTS REGARDING CAPACITY, RESPONSE-TIME PERFORMANCE, SUITABILITY FOR USE, OR PERFORMANCE OF PRODUCTS DESCRIBED HEREIN SHALL BE DEEMED TO BE A WARRANTY BY POLYCOM FOR ANY PURPOSE, OR GIVE RISE TO ANY LIABILITY OF POLYCOM WHATSOEVER.

Contact Information

Please contact your Polycom Authorized Reseller for assistance.

Polycom, Inc.
4750 Willow Road,
Pleasanton, CA 94588

<http://www.polycom.com>

About This Guide

This document explains installation and operation of Polycom's SpectraLink 6300 MCU and Base Stations. The installation process connects the SpectraLink 6000 System to the facility's telephone system, and activates the SpectraLink 6000 Wireless Telephones.

Polycom Model Numbers

This document covers the following registered model numbers:
JPI300, MCS300, RCC400, RCO400, RCU100, RCU200, RCU201

Related Documents

SpectraLink 6300 MCU: Facility Preparation (1725-36121-001)

SpectraLink 6300 MCU: Maintenance and Diagnostics (1725-36123-001)

SpectraLink 6300 MCU: OAI Installation and Configuration
(1725-36124-001)

SpectraLink 6300 MCU: Operator's Console (1725-36125-001)

SpectraLink 6300 MCU: T1 Remote Module Installation (1725-36126-001)

Installing the Outdoor Base Station (1725-36127-001)

Available at

http://www.polycom.com/support/voice/proprietary_wireless/index.html

LinkPlus Interface Guide (1725-361xx-001 where xx indicates a number corresponding to the type of PBX)

Available at

http://www.polycom.com/support/voice/wi-fi/pbx_integration.html

Customer Support

Polycom wants every customer to have a successful installation. Please refer questions to the Customer Support Hotline at (800) 775-5330. The hotline is open Monday through Friday, 6 a.m. to 6 p.m. Mountain time.

For Technical Support: technicalsupport@polycom.com

For Knowledge Base:
<http://www.polycom.com/usa/en/support/voice/voice.html>

For Return Material Authorization: rmaordinator@polycom.com

Icons and Conventions

This manual uses the following icons and conventions.



Caution! Follow these instructions carefully to avoid danger.



Note these instructions carefully.

Label

This typeface indicates a key, label, or button on SpectraLink hardware.

Contents

0 About This Guide.....	3
Polycom Model Numbers.....	3
Related Documents.....	3
Customer Support.....	4
Icons and Conventions.....	4
1 Installation Overview.....	9
Installation Steps and Responsibilities	10
2 SpectraLink 6000 System Description	11
3 SpectraLink 6000 System Components	13
The Master Control Unit.....	13
Base Stations	16
SpectraLink 6000 Wireless Telephones.....	17
Operator’s Console	18
SpectraLink OAI Gateway	18
4 Site Preparation.....	19
Required Materials Provided by Customer	20
Prepare Location for Shelves.....	22
Prepare Power for Shelves.....	26
Run Cables to Base Station Locations	26
Terminate Cables at Base Station Locations.....	28
Prepare Demarc Blocks	29

Install Demarc Blocks	32
Program Telephone System.....	32
Connect Cables from Base Stations and Phone Lines to Demarc Blocks	33
5 System Installation.....	39
Facility Analysis	39
Check Components.....	39
Install Shelves	41
Install Intershelf Junction Panel.....	42
Connect Power to Shelves.....	42
Install Cards	44
Connect the Intershelf Junction Panel.....	47
Connect Demarc Block RJ-21Cables to Interface Module	48
6 Install Base Stations	49
Mount Base Stations on Dropped Tile Ceilings.....	49
Mount Base Stations on Finished Ceilings.....	50
Install Outdoor Base Stations	51
Power Up and Check Diagnostics	52
7 System Initialization.....	53
8 Test System	55
Voice-test each Base Station.....	55
Run Listen Verify Diagnostic	56
9 Site Certification	57
10 Installation Forms	59
Site Preparation Checklist.....	59

Base Station Location Worksheet.....61

Extension Assignments Worksheet.....62

Customer Acceptance Form63

11 Safety Notices65

12 Index67

Installation Overview

Installation has three phases. In most cases, a separate person is responsible for each phase.

1. Site preparation and wire installation: Usually done by a wire technician or contractor, with the assistance of a customer representative such as a project manager. Please refer to the *SpectraLink 6300 MCU: Facility Preparation* manual for more information.
2. Installing the SpectraLink system: Done by Polycom or one of our certified distributors.
3. Programming the customer's telephone system to work with the SpectraLink system: Usually done by the customer's system administrator or technician. Please refer to the *LinkPlus Interface Guide* for instructions on programming the telephone system at the local site.

Because these major steps require some parallel activities, it is important to coordinate the activities among the persons involved. The following table lists the installation steps and the person typically responsible for each step.

Installation Steps and Responsibilities

✓	Task Description	Wire Contractor or Electrician	Field Service Engineer	Customer Project Mgr/ Sys Admin
	Site Preparation			
	Required materials provided by customer			✓
	Prepare location and arrangement of shelves			✓
	Prepare –48V power for shelves	✓		
	Run cables to Base Stations	✓		
	Terminate cables at Base Stations	✓		
	Prepare and install demarc blocks	✓		
	Program Telephone System ports			✓
	Connect cables from Base Stations and phone lines to demarc blocks	✓		
	Wire demarc blocks for Interface Modules	✓		
	Install Shelves and Interface Modules			
	Survey site and check components		✓	
	Install shelves		✓	
	Install junction panel		✓	
	Connect power to shelves		✓	
	Install cards in shelves		✓	
	Connect junction panel		✓	
	Connect demarc blocks to Interface Modules		✓	
	Install Base Stations			
	Install Base Stations in ceilings		✓	
	Install Outdoor Base Stations	✓		
	Check system diagnostics		✓	
	Initialize System		✓	
	Program handset features			✓
	Test System and Certify Site		✓	

SpectraLink 6000 System Description

This section generally explains the installation and site requirements of the SpectraLink 6000 System. The SpectraLink 6000 System is a wireless communication system that allows hand-held SpectraLink 6000 Wireless Telephones to communicate using the existing telephone system.

The SpectraLink 6000 System's advanced micro-cellular architecture utilizes Base Stations, or cells, located throughout the facility to accommodate on-premise roaming. As a handset user moves within the coverage area, the call is seamlessly passed between cells. The SpectraLink 6300 MCU supports up to 3,200 users and millions of square feet of coverage, resulting in a scalable enterprise-wide wireless voice solution.



For simplicity, this manual refers to the existing wired phone system, whether an on-premises PBX or Telco-provided Centrex system, as the "telephone system."

The SpectraLink 6000 System uses a micro-cellular design consisting of three primary components: the Master Control Unit (MCU), Base Stations, and Wireless Telephones (handsets). The following diagram shows an overview of the system.

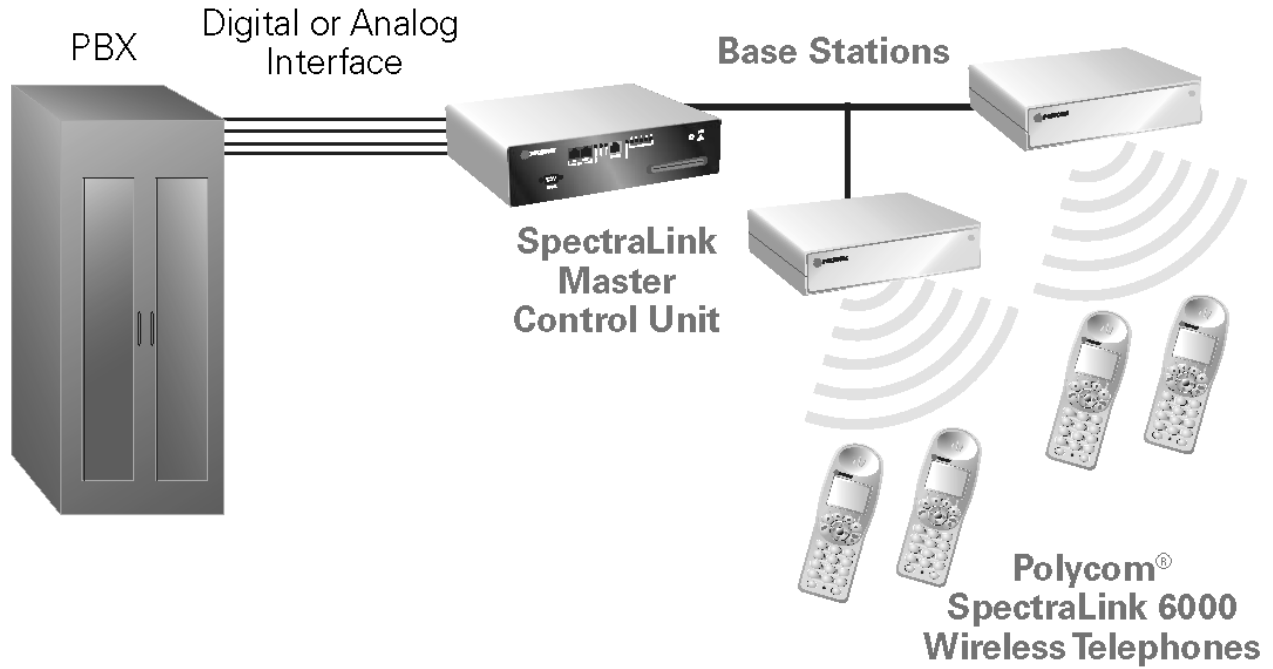

SpectraLink 6000 System

SpectraLink 6000 System Components

The Master Control Unit

The Master Control Unit is the processing center for calls to and from the SpectraLink 6000 System. It consists of at least one primary shelf (MCS300) and may have up to 19 expansion shelves. Residing adjacent to the telephone switching equipment, the MCU operates as a standalone, external system while maintaining full PBX functionality for handset users.

The MCU connects to the telephone system in two ways. The MCU can either interface with analog ports of the host telephone system or, in many cases, connect directly to the telephone system (PBX or key/hybrid system) via a digital interface. A digital interface provides the advantage that all switch features, such as call party name display and multiple line appearances, are preserved for the end user.

The MCU provides connectivity from the telephone switch to the wireless system components. Telephony ports for each handset are commissioned from the telephone switch. Base Stations, which provide the wireless link to the handsets, are wired directly to the MCU.

The SpectraLink 6000 System topology

Components in the SpectraLink 6000 System are designed in a star topology. At the center is the SpectraLink 6300 MCU. The primary shelf contains the system controller, which manages the call processing for the wireless network. Additional expansion shelf controllers manage intra-shelf calling and work with the system controller to pass calls within the wireless network and to the telephony switch. All shelves provide universal slots for up to ten Interface Modules. Interface Modules connect Base Stations and

handsets to the system. Up to 20 shelves can be connected together to maximize the system capacity.

The following diagram illustrates a sample star topology for the SpectraLink 6000 System.

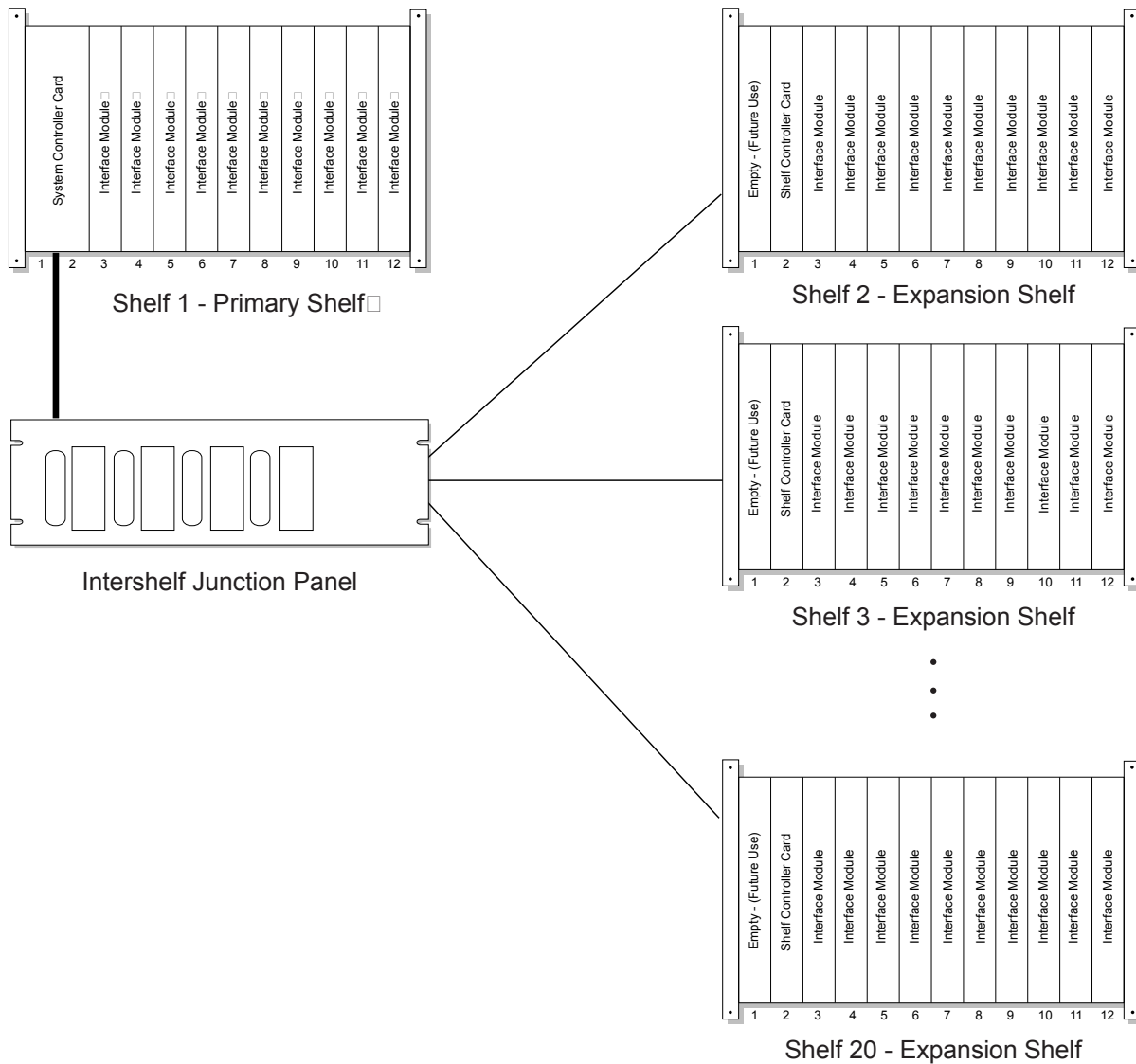

SpectraLink 6300 MCU - Star Topology

Shelf

Shelves are designed for 19" rack or wall mounting. Each shelf has 12 universal card slots. The first two slots are reserved for controller cards, the remaining ten slots are for Interface Modules. Wiring to each card is on the front panel. Power is -48V DC through the back or side panel.

System Controller (CSC or CSO301, 306, and 320)

Each system requires one system controller card, which occupies two slots (slots 1 and 2) in the main shelf. The system controller supports call routing within the entire system and to external ports. Each model number of System Controller (301, 306, and 320) supports a different number of expansion shelves. The CSO model System Controller supports Open Application Interface (OAI) enabled expansion shelves.

Two RS-232 serial ports are provided on the system controller. Serial ports can be used for multiple purposes, including local administration, remote administration and diagnostics (via modem), OAI applications and call detail recording. One standard 10-base T Ethernet port is also provided (for future use).

Expansion Shelf (CSC300, CSO300)

An Expansion Shelf Controller (CSC300) resides in slot 2 of each expansion shelf. The Expansion Shelf Controller manages intra-shelf traffic and communicates with the system controller. The CSO300 Expansion Shelf Controller supports an OAI enabled expansion shelf.



Part Numbers with a CSO prefix have the same functionality and capacity as the corresponding CSC Part Numbers and also support the Open Application Interface(OAI)

Interface Modules (CPA, CPU, CPM, CPP, CPF316)

Telephone line and Base Station connections are made to the Interface Module. Each card provides 16 line (handset) interfaces and 6 Base Station interfaces. Interface Modules are installed in slots 3 through 12 on a shelf. Interface Modules include: Analog (CPA316), Universal (CPU316), Mitel interface (CPM316), four-wire digital (CPF316), and Panasonic (CPP316). The Interface Module type is defined via the

Operator's Console and software when the card is installed. Interface Modules of different interface types can be mixed within a shelf.

Interface Modules are "hot swappable"; they can be removed and replaced without affecting service on the rest of the system.

Intershelf Junction Panel (JPI300)

The Intershelf Junction Panel (JPI300) connects Expansion Shelf Controllers on expansion shelves to the system controller, creating a completed communication channel between network elements. The Intershelf Junction Panel physically connects the network, converting RJ-21 connections from the System Controller to the RJ-45 connection on the Shelf Controller.

Base Stations

Radio Base Stations, or cells, provide the communication channel between the MCU and the handsets. The Base Station and handset use digital spread spectrum radio transmission in the 902-928 MHz frequency band.

Each Base Station supports multiple users and covers a transmission area in excess of 50,000 square feet. The signal propagation is dependent on transmission obstructions within the building. A call is passed from one Base Station to another as the user walks throughout the coverage area. The SpectraLink 6000 System is designed to provide seamless coverage, enabling real-time hand-off of active calls.

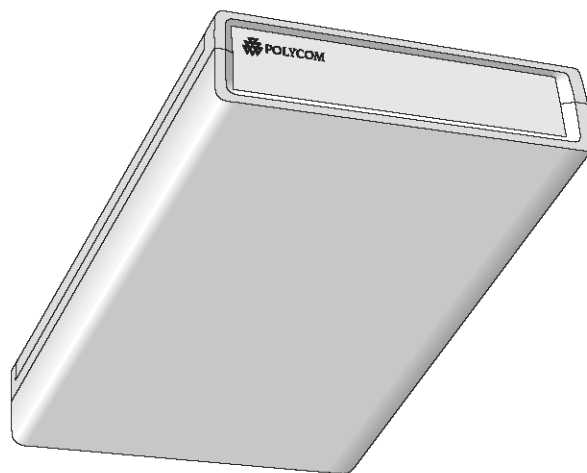

Base Station

ccSpectraLink 6000 System

The ccSpectraLink 6000 System (WTS) is designed to meet the high simultaneous call capacity and advanced level of telephone feature integration of the call center environment. The ccSpectraLink 6000 System uses a special High Density Base Station which can be installed with minimal spacing (as little as 20 feet between Base Stations.)

SpectraLink 6000 Wireless Telephones

The SpectraLink 6000 Wireless Telephone is a durable wireless telephone that operates with all the functionality of a wired desk phone. Weighing only six ounces and ergonomically designed, the handset is comfortable and easy to use. The monolithic design of the handset, with no moving parts, will withstand a physically demanding work environment. The handset's alphanumeric display supports messaging from either the telephone switching equipment or an external data application. The handset provides up to four hours of talk time and 80 hours of standby between battery recharges.

When the SpectraLink 6000 System is connected to the telephone system using analog ports, the handset will provide many of the calling features of a desk phone, including transfer, conference calling, and hold. When the system is digitally interfaced to the phone system, the handset will also support the advanced features of the host telephone system such as calling party name display and multiple line appearances.



SpectraLink 6020 Wireless Telephone

Each handset requires a line appearance (port) from the telephone system. Typically the handset extension number corresponds with the user's internal telephone extension number. On most switching systems the user's desk phone and the handset port can be bridged so that incoming calls ring both phones simultaneously.

Operator's Console

The system uses a proprietary software program for administration and maintenance. The software is loaded to the Operator's Console, an IBM-compatible personal computer, located close to the SpectraLink 6300 MCU. The PC is used to register each handset and Base Station, enter user information, monitor system operations, and initiate remote diagnostics.

SpectraLink OAI Gateway

The SpectraLink OAI Gateway and application server are optional components which enable third-party applications (such as nurse call systems) to communicate with SpectraLink Wireless Telephones.

Site Preparation

The following steps must be completed before installing the system hardware. If the steps are not already completed refer to each individual section for details.

- ❑ MCU location prepared. Typically the MCU is installed in the telephone equipment room. This location must have sufficient backboard space or rack space, and -48 volt power available.
- ❑ The correct number of cross-connect blocks (or equivalent) are installed and connected to a 25-pair Telco wire terminated with an RJ-21 male connector at the MCU location. The number of blocks required depends on the number and type of Interface Modules installed. Refer to Chapter 4, section *Prepare Demarc Blocks* for more information.
- ❑ A two-pair cable to each Base Station as designated on the building floor plans.
- ❑ The Base Station wiring is terminated with RJ-45 crimp-on plugs at the designated Base Station locations. Refer to Chapter 4, section *Terminate Cables at Base Station Locations* for more information.
- ❑ The Base Station wire is terminated at the appropriate cross-connect demarc blocks. Refer to Chapter 4, section *Connect Cables from Base Stations and Phone Lines to Demarc Blocks*.
- ❑ The analog or digital phone extensions from the phone system are terminated at the appropriate cross-connect demarc block and the block is labeled. Refer to Chapter 4, section *Connect Cables from Base Stations and Phone Lines to Demarc Blocks*.
- ❑ A dedicated dial line is available with an RJ-11 jack for the diagnostic modem.
- ❑ An IBM-compatible PC is available to serve as the Operator's Console for system administration.
- ❑ A system administrator is designated for the SpectraLink system. This person should be present for the installation. The Polycom field service engineer will provide system training to the system administrator on the day following the installation.

Required Materials Provided by Customer

Required hardware

- ❑ **Rack** The shelves are designed to fit into a 19" mounting rack. Each shelf measures 15" high x 19" wide x 9" deep, and weighs approximately 35 pounds fully loaded.
- ❑ **Backboard Space** As an alternative to rack mounting, the shelves can be wall mounted to 3/4" plywood securely screwed to a wall.
- ❑ **Screws** Required to mount the shelves to the wall, or to secure it in the rack. For wall mount, six #10 5/8" panhead wood screws (or similar device) are required. For rack mount, screws required are determined by the rack requirements; typically 10-32 or 1/4-20. For multi-shelf systems, four 1.75" #8 panhead wood screws are required to secure the Intershelf Junction Panel to the backboard, along with standoffs at least 1.5" long with 1/4" inside diameter.
- ❑ **Power and Conduit** -48V Power Source and conduit for connection, either 1/2" BX metallic or NMX conduit. Three #8 insulated rings for use with #14 AWG wire are required for each MCS300 to be installed.
- ❑ **25-Pair Cables** RJ-21 male at MCU end, required to connect the shelves to the cross-connect blocks.
- ❑ **Cross-Connect Blocks** Required to connect the PBX ports and the Base Stations to the MCU.
- ❑ **Quick Clip Fuse** Required with an RCO400 Outdoor Base Station or when a Base Station is located in a separate building from the SpectraLink 6300 MCU. Recommended Quick Clip Fuse is available from Reliable Electric, Model # RSCP-2.
- ❑ **Ladder** Polycom installation crew will require a ladder to reach the Base Station locations. Ensure that a ladder of adequate height is available for the crew's exclusive use upon arrival.

Operator's Console PC

A PC must be available to perform system administration and diagnostics. The PC must conform to the following specifications:

- An IBM-compatible personal computer, 486 or above (with a 16 MHz clock or faster)
- A hard disk with at least 2 Mbytes free space
- At least 640k bytes of RAM
- MS-DOS 3.2 (or later), or MS-Windows 95 (or above) or NT
- A 3 1/2" floppy-disk drive (high density, 1.44 Mbytes)
- One RS-232 serial port for connection to the system controller

If remote access is required, the customer must supply an external modem, 9600 baud or faster.

System administrator

One person (or more, depending on the size of the system) must be designated as the system administrator for the SpectraLink 6000 System. This person is often also the company's telephone system administrator. This person should know the location of the company's current telephone equipment, have access to the telephone room, know the telephone system's feature codes, and should be present for the installation. If there is not currently a person carrying out such duties, someone must be designated as system administrator.

The system administrator's tasks are minimal but may take up to two hours per week for a large system. The system administrator should have access to the location of the SpectraLink system and be competent to perform the following functions:

- Swap system components (handsets, Base Stations)
- Swap an Interface Module
- Perform or direct basic moves, adds and changes to a telephone system
- Perform or direct the receiving and shipping of components
- Train users with video and handouts

The system administrator should be available for training at the time of the Polycom installation. The system administrator is given

unlimited access to the Customer Support Hotline for additional assistance.

Union labor

In some areas strict labor union rules will preclude the Polycom representative's ability to install the equipment without union assistance. If such rules are in force in the local area, the customer must ensure that sufficient union help is available at the scheduled installation time to carry out the following functions:

- Install Base Stations
- Move and reinstall Base Stations
- Make cabling changes at cross-connect blocks
- Run cables
- Make and modify electrical connections

Prepare Location for Shelves



Polycom recommends an operational temperature range of 0°–40° C (31°–104° F). Optimal temperature is 20° C (68° F). Humidity recommendation is 20%– 80% (non-condensing).

The MCU, composed of up to 20 shelves and one Intershelf Junction Panel, is usually installed in or near the telephone equipment room. If this is not possible, the MCU can be located anywhere that the telephone system lines are accessible.

The number and arrangement of the system shelves depends on the size and configuration of the system.

System Controller Part Number	Shelves Supported	Base Stations Supported	Users Supported
CSC301/ CSO301	1	60	160
CSC306/ CSO306	6	360	960
CSC320/ CSO320	20	1,000	3,200

Consideration should be given to:

- Environmental conditions. The system outputs 28 BTUs per hour, per interface module.
- Space for the backboard or rack.

- Space for the shelves, which are designed for 19" rack or wall mounting.
- Each shelf measures 15" high x 19" wide x 9" deep, and weighs approximately 35 pounds fully loaded.
- Expansion shelves cannot be located more than 17 cable feet from the Primary Shelf.
- All digital interface modules must be within 250 feet of the telephone system.
- See your telephone system specifications for distance limitations for analog modules.
- Location of the Intershelf Junction Panel (JPI300) adjacent to the shelves on a multi-shelf system.
- The Primary Shelf containing the System Controller (CSC or CSO306 or 320) must be mounted to allow connection to the JPI300 with a five-foot cable.
- Expansion Shelves (CSC300 or CSO300) must be mounted to allow connection of the shelf to the JPI300 using 12 feet or less of cabling.
- Space for the -48V power supply connections. Power supply conduit requires clearance of 1.5" on the rear or side of the shelves.
- Maximum loop length specifications of the telephone system
- Maximum wire distance from the MCU to a Base Station (6,000 feet)
- Cabling for the Interface Modules and Controller cards. All cables (except power) are connected to the front face of the cards. Space is provided to route wiring to the back of the shelf.

Prepare rack or wall

The SpectraLink 6300 MCU can be mounted in a rack or on the wall. Rack or wall support must be adequate to support the number of shelves to be installed. Each fully loaded SpectraLink 6300 MCU shelf weighs approximately 35 pounds.

Rack mounting

Before installing shelves in a rack, be sure the rack is mechanically fastened to the floor or wall such that it properly supports the number

of shelves to be mounted. Follow the manufacturer's instructions to prepare the rack.

Be sure to leave 1.5" clearance at the rear of the racks for power conduit.

Wall mounting

Before wall mounting, cover the wall with 3/4" plywood. Secure the plywood to the wall studs every 16" with an adequate number of screws to support the number of shelves to be mounted. Each fully loaded shelf weighs approximately 35 pounds. Be sure to leave 1.5" clearance on the left side for power conduit.

Using the following drawing as a guide, drill six pilot holes using a 1/8" drill bit.

Insert the six screws (#10 panhead wood screws, 5/8" long) into the pilot holes and tighten them, leaving approximately 1/8 to 1/4" gap from the wall.

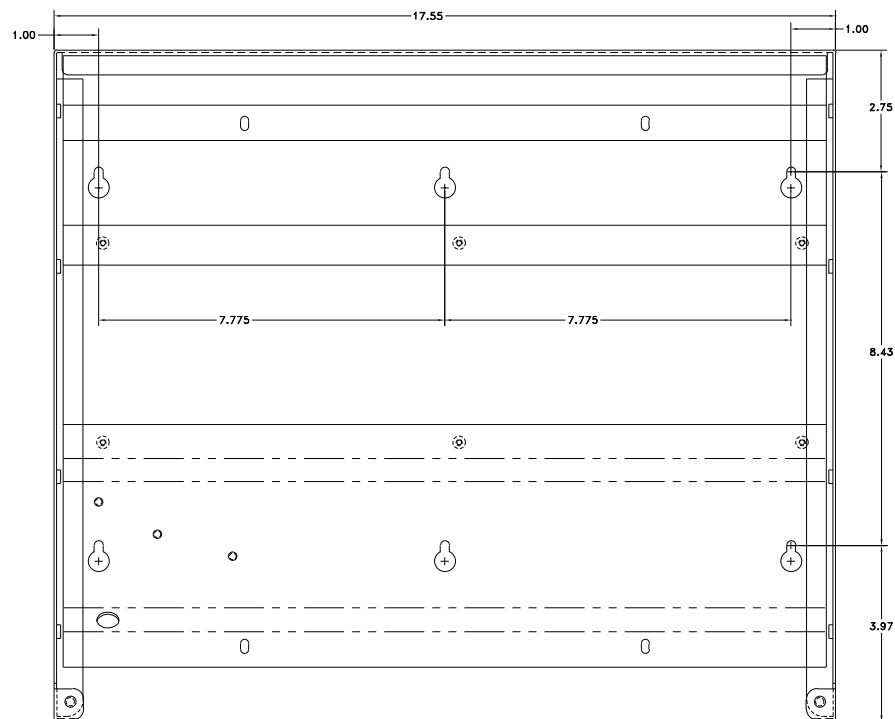

Wall Mounting Dimensions

Prepare Power for Shelves

The SpectraLink 6300 MCU requires a -48V DC power source. The -48V connection is comprised of three wires: -48, +48 (neutral), and ground.

Polycom recommends that a licensed electrician install the -48V power source. It must be installed according to current National Electrical Code (NEC) or National Fire Protection Code standards, in accordance with all local and municipal electrical code recommendations.

Use of 14 AWG wire is recommended.

See Chapter 4, section *Connect Power to Shelves* for more information on power connections.



When connecting the -48 V DC system to power, note the following precautions:

A 30 amp circuit breaker must be present on the non-grounded DC circuit conductor, and the installer must ensure that means are provided for connection of the equipment to the DC source by permanent wiring methods, and no disconnecting device is located in the grounded DC circuit conductor between the point of connection to the supply and the point of connection to the grounding electrode and equipment grounding conductors.

Run Cables to Base Station Locations

The Base Station locations should be designated on the building floor plans provided to the field service engineer. Base Stations can be mounted easily on raised or acoustical ceiling tiles, or on the wall. Avoid locating Base Stations in high or hard-to-reach places, as this will hinder maintenance, testing, or repositioning.

Wire specifications



The customer's wire contractor is responsible for adhering to all local codes for wiring.

Polycom recommends UL-listed wire that conforms to the following specifications for AWG, distance, and number of power pairs required for this installation.

Power Pairs	Max Cable Feet 22 AWG	Max Cable Feet 24 AWG	Max Cable Feet 26 AWG
1	6,000	3,800	2,400
2	N/A	6,000	4,800
3	N/A	N/A	6,000



One additional pair is also required for Data.

For wire runs of less than 3,500 feet, attenuation must not exceed 6.8 dB/1,000 feet at 772KHz.

For wire runs between 3,500 and 6,000 feet, attenuation must not exceed 4.5 dB/1,000 feet at 772KHz.

Wire that is already installed (spare house cable) can be used when it is available. House cable will usually run from the MDF in the telephone equipment room to intermediate distribution frames (IDFs) spread throughout the facility. Install new wire from the closest IDF to the Base Station. Be sure no bridge taps, multiples, or "Y" connections are created or present.

Determine the amount of wire needed to connect the Base Station to the MCU by scaling from a floor plan or a sketch, pacing, measuring, or estimating. Remember to include enough wire to reach the ceiling.



The wire length between the MCU and each Base Station may not exceed 6,000 cable feet.

Install an extra 25 feet of wire at the Base Station to allow for possible relocation.

Pull cable

Pull the cable from the MCU location (usually in the telephone equipment room) to the Base Station locations designated on the floor plans.



If the cabling exits the building, refer to Chapter 6, section *Install Outdoor Base Stations*.

Run all cable before attaching the RJ-45 connectors to the Base Stations. Label both the demarcation block end and the Base Station end of each wire with the Base Station number using a wire tie marker or other form of marker.



Remove bridge taps, multiples, or “Y” connections to the Base Station wires; these will cause data transmission errors. When using IDFs be sure that the total wire length from the MCU to each Base Station does not exceed **6,000 cable feet**.

The area above some suspended ceilings is used as an environmental air plenum. The NEC requires that wire that is installed in plenums be rated for plenum installation.

Terminate Cables at Base Station Locations

Terminate cable at the Base Station using an RJ-45 modular crimp-on plug.



To avoid damage to the connectors or crimps, be sure to run the wire to the Base Station before connecting the RJ-45 connectors.

After running the wire to the Base Station location, terminate the wire using an RJ-45 modular crimp-on plug. Connect the data pair to pins 1 and 2 and the power pair to pins 7 and 8. **These connections are not polarity sensitive.**

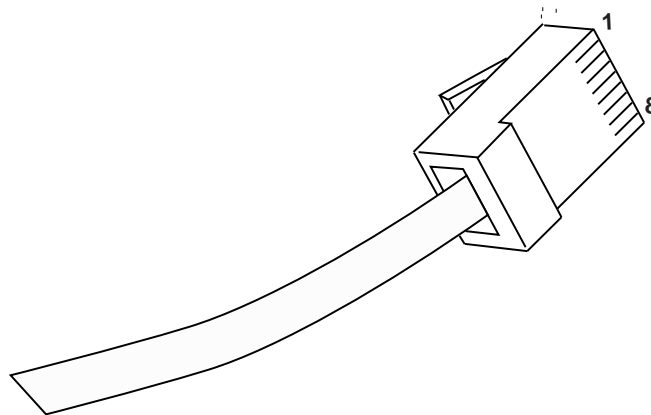

RJ-45 Modular Cable

When wiring multiple power pairs, use the following table as a guide.

Pair	Function	Pin #s
1	Data	1,2
2	PWR 1	7,8
3	PWR 2	4,5
4	PWR 3	6,3

Power pairs are polarity sensitive; pins 7, 4, and 6 must be the same polarity.

Prepare Demarc Blocks

Interface Modules are designed to operate with a specific interface to the telephone system: two-wire digital or analog, or four-wire digital (future release). The number of demarcation blocks required for the system depends on the number and type of Interface Modules to be installed.

Interface Type	Interface Module Part Number	Wire Pairs	# Blocks
Analog POTS	CPA316	1	1
Universal (Comdial, DEFINITY, Meridian 1, Norstar, Rolm)	CPU316	1	1
Four-wire digital	CPF316	2	2
Mitel (DNIC)	CPM316	1	1
Panasonic	CPP316	1	1



The CPU316 and CPM316 Interface Modules are intended only for connection to the isolated-side of an on-premise PBX. These interfaces are intended to connect to digital PBX ports that provide signals of 5Vp-p (max) AC component and some PBXs providing a 48Vdc offset.

Base Station wiring is the same for all Interface Modules.

Based on the number and type of interfaces in the system, determine the number of 25-pair cables required to connect line ports and Base Stations to the demarcation blocks. The diagrams which follow provide an overview of the connections.

Multiple power pairs

Some sites may prefer to wire Base Stations to a separate demarc block in order to split out power pairs.

Two-wire analog or digital interface

The wiring diagram below shows the connections required for a two-wire analog or digital interface. The Interface Module can be a CPA316, CPU316, CPP316, or CPM316.

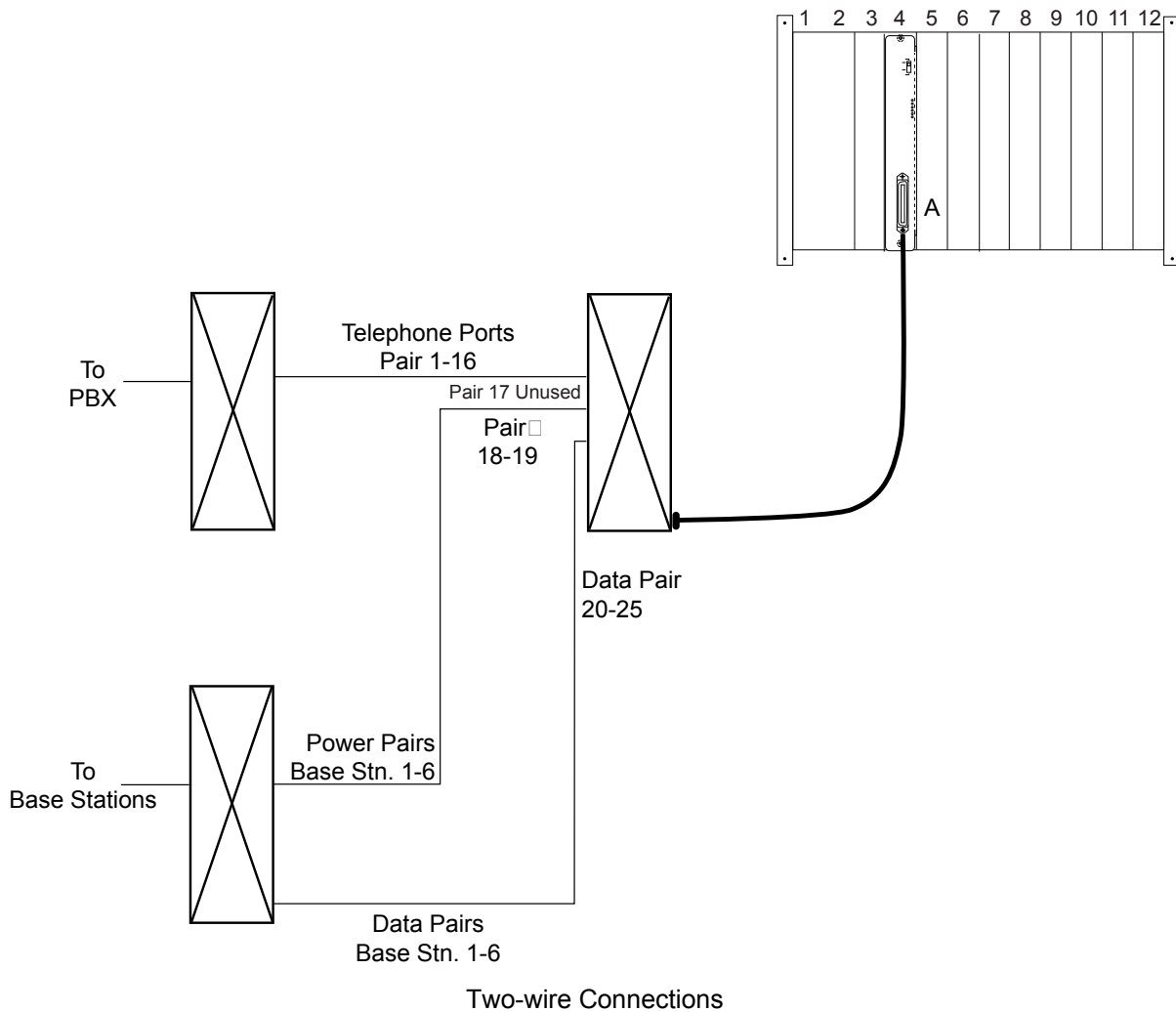

Four-wire digital interface

The wiring diagram below shows the connections required for a four-wire interface (CPF316). Each Interface Module of this type requires two backboards which will be wired as indicated.

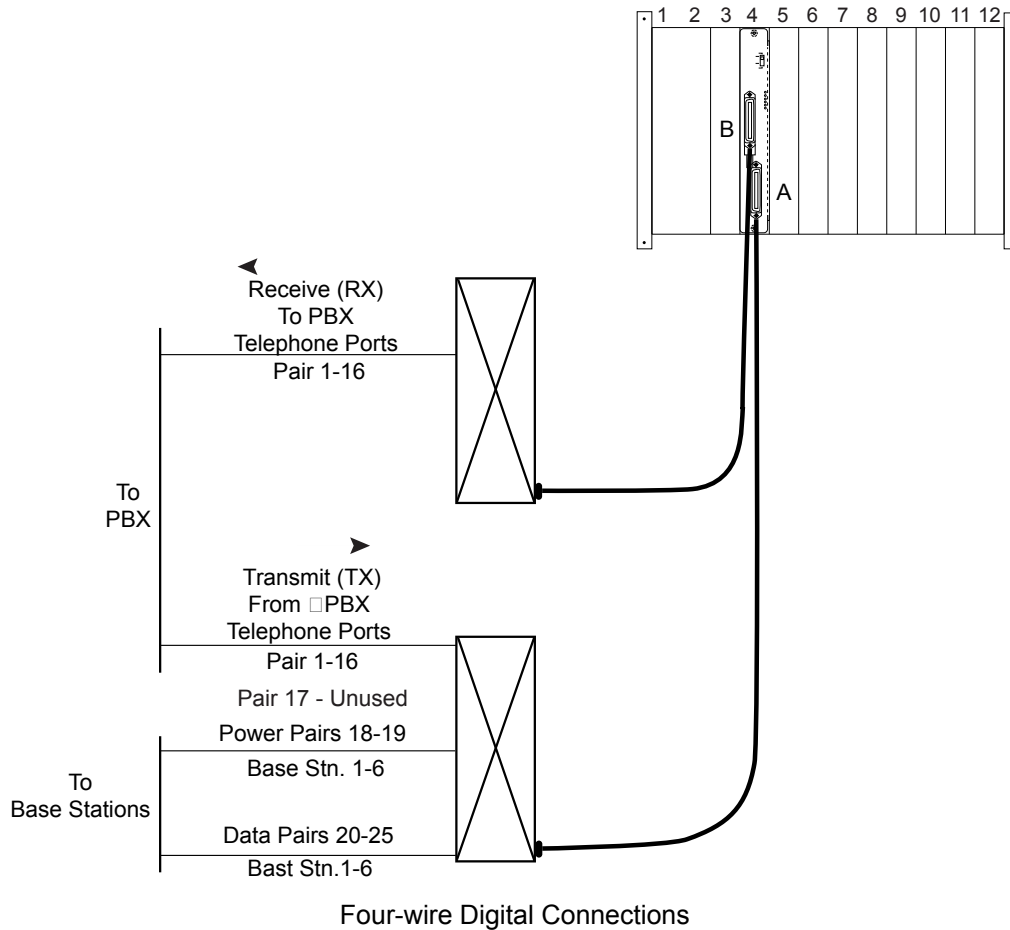

Install Demarc Blocks

The demarcation blocks used to connect the telephone system and Base Stations to the MCU should be installed on a typical telephone facility backboard. A 1/2" or 3/4" thick board mounted on the wall near the MCU is typical. Although this manual uses 66 blocks as examples, any standard cross-connect blocks are acceptable.



If the wiring between the MCS300 and the telephone system leaves the building, consult the telephone system manual, the NEC, and local codes for instructions on providing lightning and other over-current protection.

Program Telephone System

Plan location of lines and Base Stations on Interface Modules

Each Interface Module can support 16 handsets and six Base Stations. Consider the usage and traffic patterns at this site in determining the placement of lines and Base Stations on each Interface Module. To obtain maximum calling capacity, locate handsets and Base Stations which will be used by those telephones on the same shelf.



Interface Modules of different interface types may be mixed within a shelf. However, within a given Interface Module, all ports must interface to the same type of telephone system.

Assign and program ports

The wire contractor should inform the system administrator which port numbers have been designated for the handsets and the remote diagnostics modem line.

The system administrator must assign extension numbers to the handsets and plan the functions (trunk access, toll restrictions, system features, ringing options etc.) to be programmed for the handsets. This programming will be done after the handsets are registered, but

will be faster if it is planned in advance by verifying the parameters and features on the current telephone system and-wired phones.

For details, refer to the *LinkPlus Interface Guide* for the type of telephone system for the system controller in use.

Connect Cables from Base Stations and Phone Lines to Demarc Blocks

Two-pair twisted cable from Base Stations installed throughout the facility converge at the demarc block or backboard. Each Interface Module can support six Base Stations and 16 handsets. The Base Station and handset cables are punched down onto the Interface Module cross-connect blocks as shown in the demarc block diagrams below.

Photocopy the *Base Station Location Worksheet* and *Extension Assignments Worksheet* as needed. Use the forms to track the Base Stations and handset port assignments connected to each Interface Module. As the field service engineer punches down each Base Station or handset connection, fill in the information on the form to identify the position of the Base Station or handset (the building and floor number, for example) and a detailed description of the location (perhaps a room number). A copy of this form should be posted near the cross-connect block.



Up to six Base Stations can be connected on a single Interface Module. Each Base Station uses two pair; one for data and one for power, so 12 pairs will be used to wire six Base Stations.



When wiring an external Base Station or a Base Station with wiring that exits the building, protect all Base Station wiring with the Quick Clip Fuse (Reliable Electric RSCP-2) before bridging with other Base Station power leads.

If the wiring between the MCS300 and the telephone system leaves the building, consult the telephone system manual, the NEC, and local codes for instructions on providing lightning and other over-current protection.

Two-wire analog or digital demarc block

The demarc block for the two-wire analog or digital interface should be wired as follows:

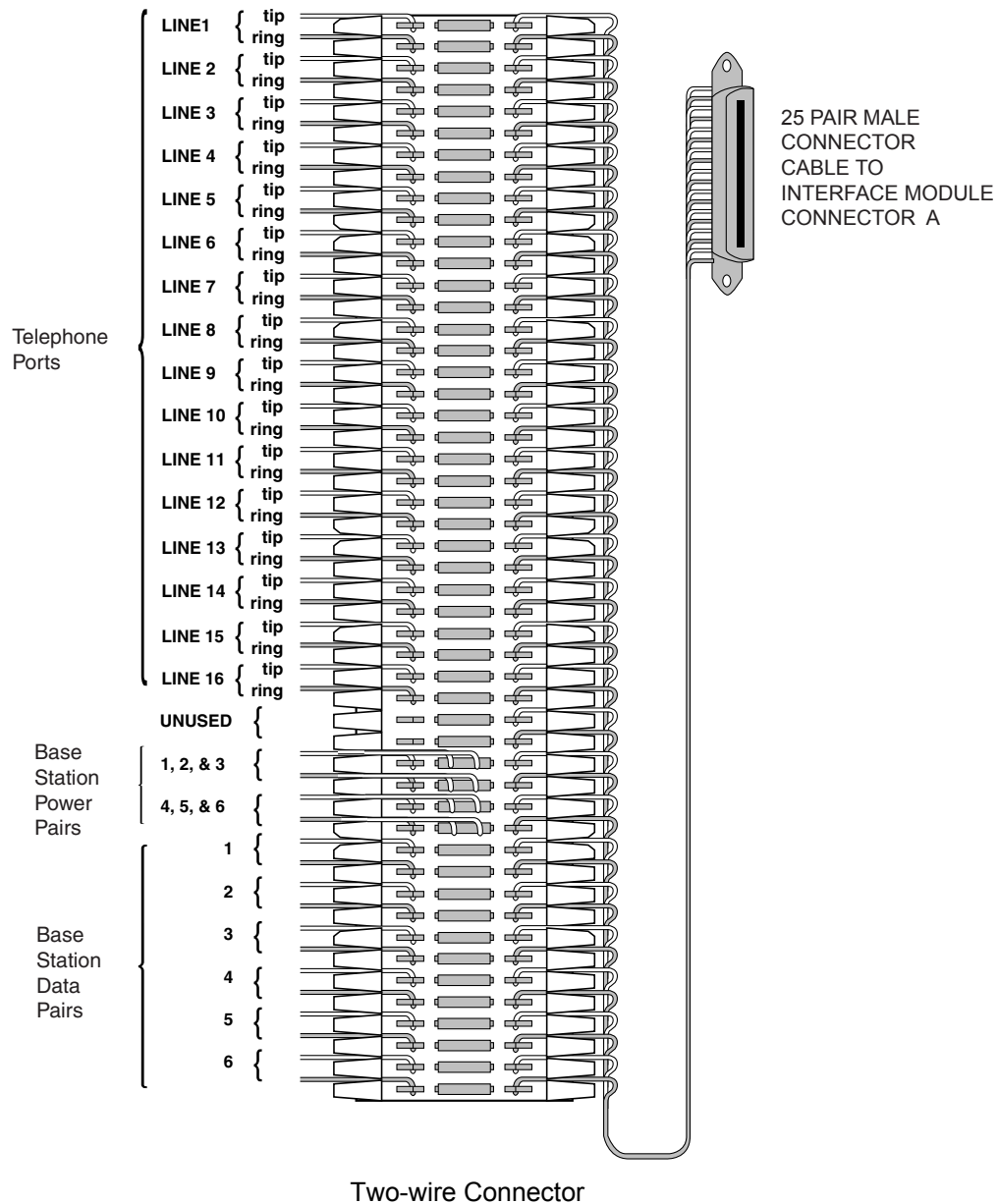

Four-wire digital demarc block

The four-wire digital interface (future release) requires two demarc blocks, one to Connector **A** and one to Connector **B** on the Interface Module. They should be wired as follows:

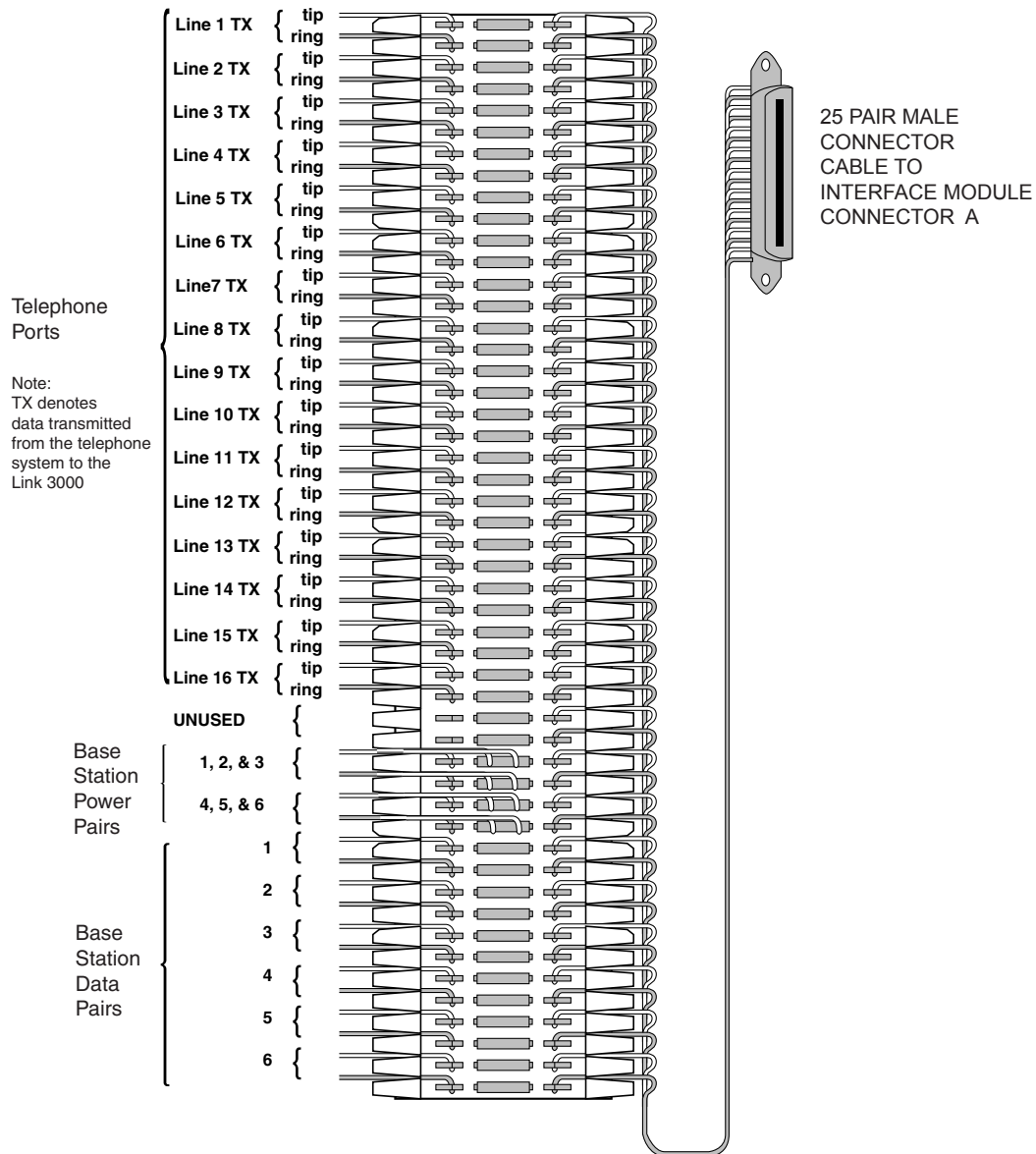

Four-wire Digital – Connector A

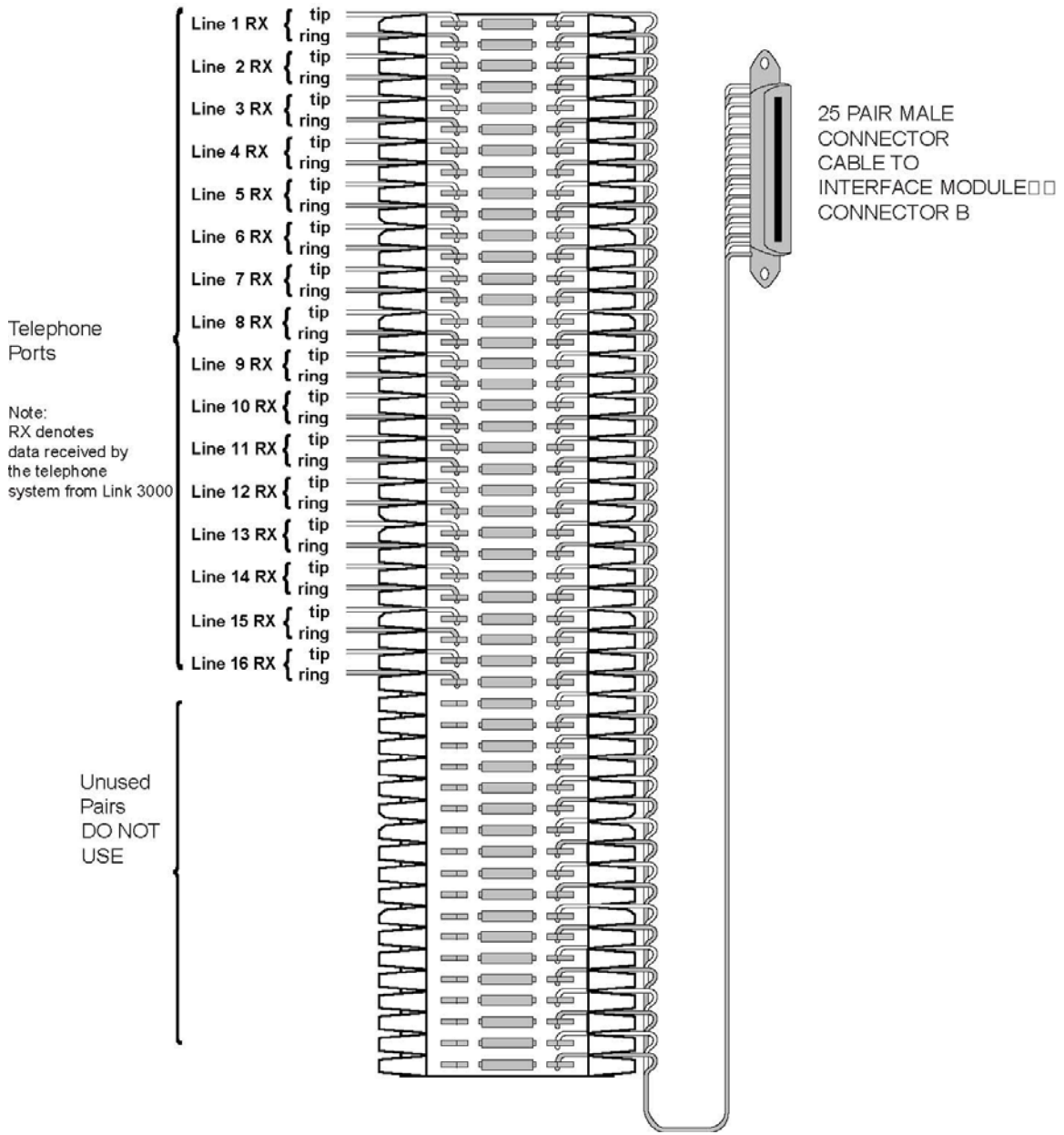

Four-wire Digital – Connector B

Connect demarc block 25-pair cable

In some installations the demarc block is connected to the Interface Module using a 25-pair Telco cable with one male and one female RJ-21 connector. The female connector is plugged into the right side of each cross-connect block. The male connector from each cable will be connected later to the front of the Interface Module.



Be sure to use only cables that are UL-listed communications circuit accessories. Only 24 of the 25 pairs are used in the Interface Module cable.

System Installation

Facility Analysis

Check the site to be sure pre-installation work has been completed correctly. This includes:

- Location chosen for the shelves is adequate.
- Rack (if rack mounted) is properly secured or backboard (if wall mounted) is properly prepared.
- Power is available.
- Wiring to Base Station locations has been pulled and correctly terminated.
- Phone lines for the handsets are installed and properly terminated.
- Telephone system administrator is on-site to program the existing telephone system.
- If the work has not been completed, the Polycom Field Service Engineer may leave the site and reschedule the installation when the items have been completed or corrected, or may assist in preparing the site.

Check Components

At the installation site, unpack the system carefully, verify that there is no shipping damage, and store in a safe place. As the field service engineer unpacks, he or she must confirm that contents are correct by comparing with the shipping documents.



Before beginning the system installation, begin charging a handset. The Battery Packs for the handsets are not charged when shipped. At least one fully charged handset is required to test the system.

The following items should be at the installation site.

- ❑ **SpectraLink 6300 MCU Shelves (MCS300)** Depending on the size of the system, there may be up to 20 shelves.
- ❑ **SpectraLink 6000 System MCU Administration Kit (MKA320)**
Includes a grounding strap to protect cards from electrostatic discharge; an external modem for remote access to the system; and documentation including a *User Guide* for each handset, and a videotape that explains basic usage of the handset.
- ❑ **System Controller Card (CSC301, CSC306, or CSC320)** One card for each system. This card is double width and installed in slots 1 and 2 of the Primary Shelf.
- ❑ **OAI System Controller Card (CSO301, CSO306, CSO320)** On systems that support OAI, one card for each system. Expansion shelves must be equipped with OAI enabled system controllers (CSO300).
- ❑ **Expansion Shelf Controller Card (CSC300 or CSO300)** One card for each Expansion Shelf. This card is installed in slot 2 and connected to the system controller by an Intershelf Junction Panel.
- ❑ **Cables** Two 12-foot RJ-45 cables with each Expansion Shelf Controller (CSC300).
- ❑ **Interface Modules** The correct number and type of Interface Modules to connect the handsets and the Base Stations to the telephone system. Interface Modules can support analog (CPA316), Universal (CPU316), Panasonic (CPP316), four-wire (CPF316) or Mitel (CPM316) interfaces.
- ❑ **Intershelf Junction Panel (JPI300)** Converts the RJ-21 connections on the System Controller Card to the RJ-45 connections on the Expansion Shelf Controller Card. Includes one RJ-21 Male/Female cable, five feet long, to connect the Primary Shelf to the JPI300.
- ❑ **Wireless Telephones** The correct number of handheld Wireless Telephones (PTB400 or PTB410) for this installation.
- ❑ **Battery Packs** The system may have one or more spare Battery Packs per handset, depending on the needs at your location.
- ❑ **Battery Chargers** SpectraLink 6000 Wireless Telephones require a Battery Charging system, usually one per handset.
- ❑ **Base Stations** The correct number of indoor (RCC400), outdoor (RCO400), or high-density (RCH400) models for this installation.
- ❑ **Base Station Mounting Hardware** A ceiling clip and plastic bolt used to attach each Base Station to the T-bar ceiling tile grid.

Install Shelves

Rack mount

To install shelves in the rack, slide the shelves into the rack and secure them to the rack using 8 screws, 1/4" minimum length.

Wall mount

At this point in the installation process, there should be a backboard securely fastened to the wall and mounting screws partially inserted into the backboard. See Chapter 4, section *Prepare Location for Shelves* for more information.

To attach the shelves to the wall:

1. Remove all cards from the shelf. Do not mount the shelf with cards installed.



Cards contain components that may be damaged by electrostatic discharge. Before handling any of the cards, attach the grounding strap (included in the Administration Kit) to your wrist, and attach the other end of the strap to ground. Handle cards only by their edges. Do not touch connector contact areas. Do not lift cards by any of the components. Do not lay cards down on their component sides. When laying a card down, place it component side up, on top of the anti-static bag in which it was shipped.

2. Position the MCS300 so that the six mounting screws are aligned with the six keyhole openings in the back of the shelf.
3. Slide the shelf down onto the screws to lock the shelf into place. Check that all six screws are properly locked.
4. Tighten all six screws fully.



Do not install cards until power is connected.

Install Intershelf Junction Panel



The Intershelf Junction Panel (JPI300) is to be installed only in restricted access areas (dedicated equipment rooms, equipment closets, or the like), in accordance with Articles 110-16, 110-17, and 110-18 of the NEC, ANSI/N FPA 70.

The expansion shelf controllers of shelves 2 through 20 are connected to the system controller by an intershelf junction panel. The panel converts the RJ-21 connections on the system controller to the RJ-45 connections on the expansion shelf controller.

Install the panel in the rack or on the wall adjacent to the Primary Shelf, which contains the system controller (CSC306 or CSC320).

Wall mounting requires 1.75" #8 panhead wood screws. The panel must be mounted with standoffs at least 1.5" long and 1/4" inside diameter.

Connect Power to Shelves

Polycom recommends that a licensed electrician install the -48V DC power supply and connect power to the shelves.



When connecting the -48 V DC system to power, note the following precautions:

A 30 amp circuit breaker must be present on the non-grounded DC circuit conductor, and the installer must ensure that means are provided for connection of the equipment to the DC source by permanent wiring methods, and no disconnecting device is located in the grounded DC circuit conductor between the point of connection to the supply and the point of connection to the grounding electrode and equipment grounding conductors.



The DC input to the power supply is polarity sensitive. Incorrect hookup will prevent normal operation of the system and may cause damage. Double check polarities before making any connections. Verify that the DC power switch on each shelf is OFF.

Run conduit to shelf

The shelves have two possible points of entry for conduit: on the side, used for wall mounted shelves, or in the rear, used for rack mounted shelves.

Select the point of entry (side or rear) for this installation and unplug the correct opening on each shelf to be installed.

For each shelf:

1. Attach the conduit entry hardware (condulet) to the conduit.
2. Pull the conduit through the hole.

Connect wire to terminals

Connect the wire to the terminal strip and grounding stud, as shown in the following illustration. Position the wires to be flat against the back of the shelf.

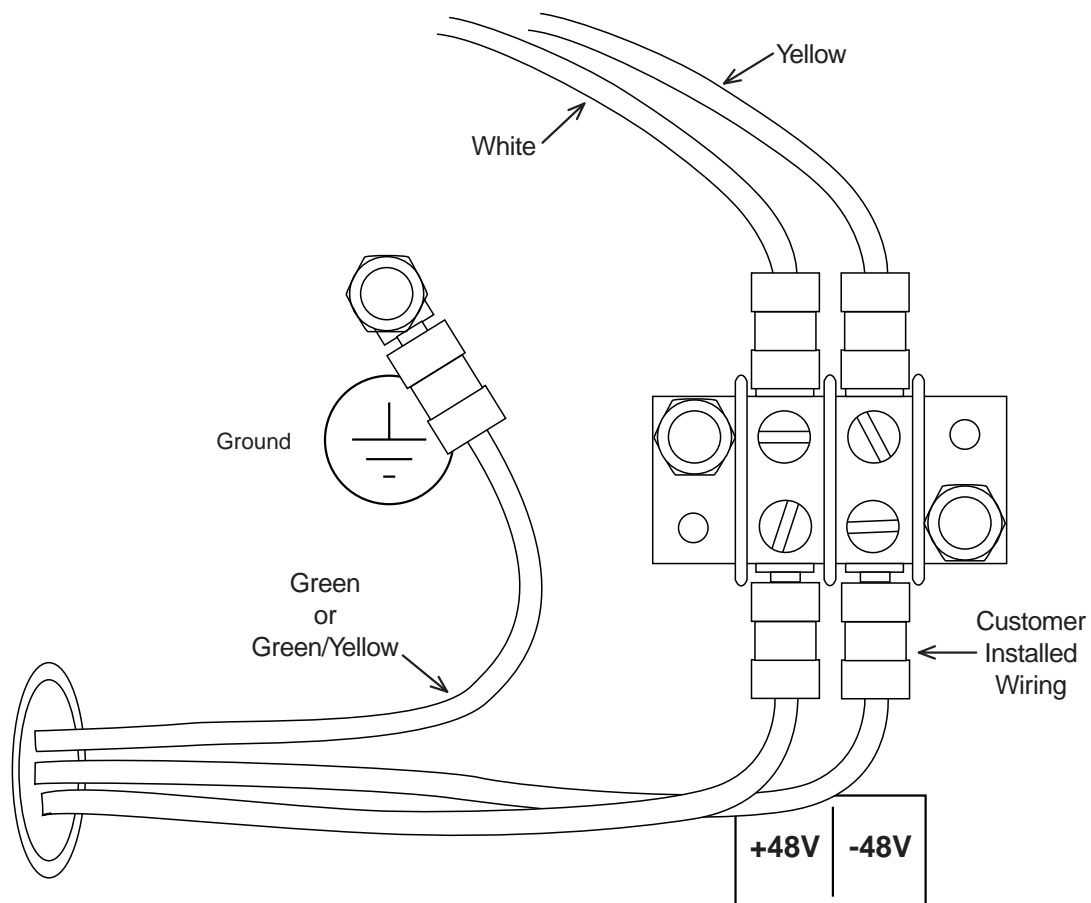



Before turning on the power switch, use a voltmeter to verify that the terminal labeled -48V is negative with respect to the terminal labeled +48V.

Install Cards



Cards contain components that may be damaged by electrostatic discharge. Before handling any of the cards, the installer must attach the grounding strap (included in the Administration Kit) to his or her wrist, and attach the other end of the strap to ground. Only handle the cards by their edges. Do not touch connector contact areas, do not lift cards by any of the components, and do not lay cards down on their component sides. When laying a card down, place it component side up on top of the anti-static bag in which it was shipped.

Install System Controller Card (CSC301, CSC306, CSC320)

Slide the System Controller Card into slots 1 and 2 of the Primary Shelf, until the card clicks into place. Tighten the screws at the top and bottom of the card to secure it.

Install Interface Modules (CPA, CPU, CPM, CPP, CPF316)

Slide the first Interface Module into slot 3 of the Primary Shelf, until the card clicks into place. Tighten the screws at the top and bottom of the card to secure it.

Slide additional Interface Modules into their slots. Slots can be left empty if desired.

The shelf diagram below shows a fully loaded Primary Shelf. Any type of Interface Module can be installed in slots 3 through 12.

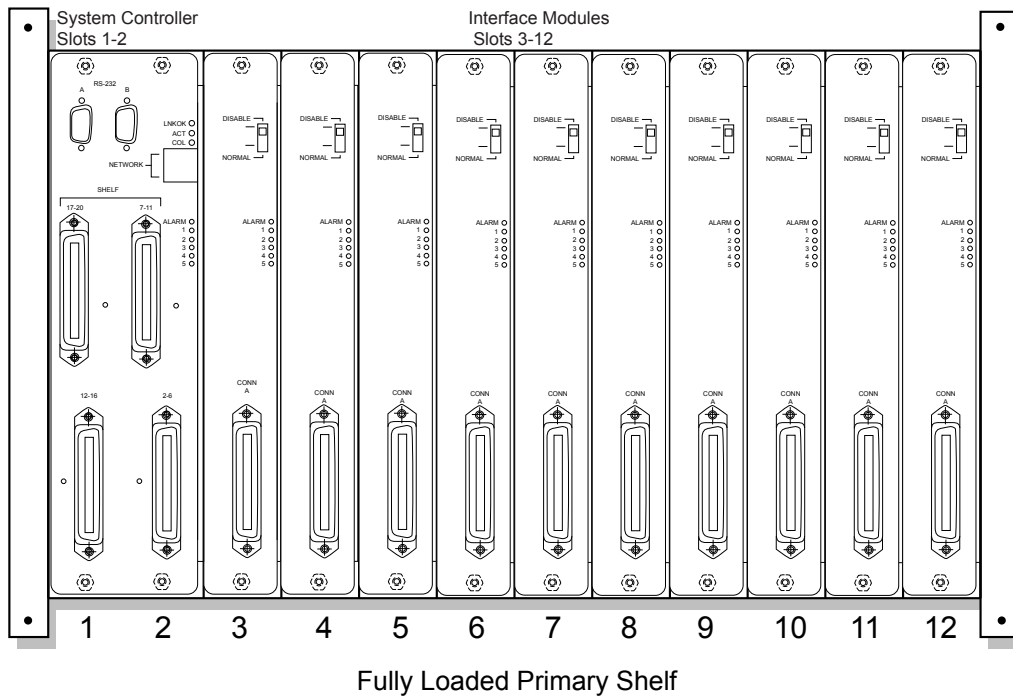

Install Expansion Shelf Controllers (CSC300)

Slide the Expansion Shelf Controller Card into slot 2 of each shelf (2 through 20), until the card clicks into place. Tighten the screws at the top and bottom of the card to secure it.

Slide the Interface Modules into slots 3 through 12 of each shelf (2 through 20) until the card clicks into place.

The shelf diagram below shows a fully loaded Expansion Shelf. Any type of Interface Module can be installed in slots 3 through 12.

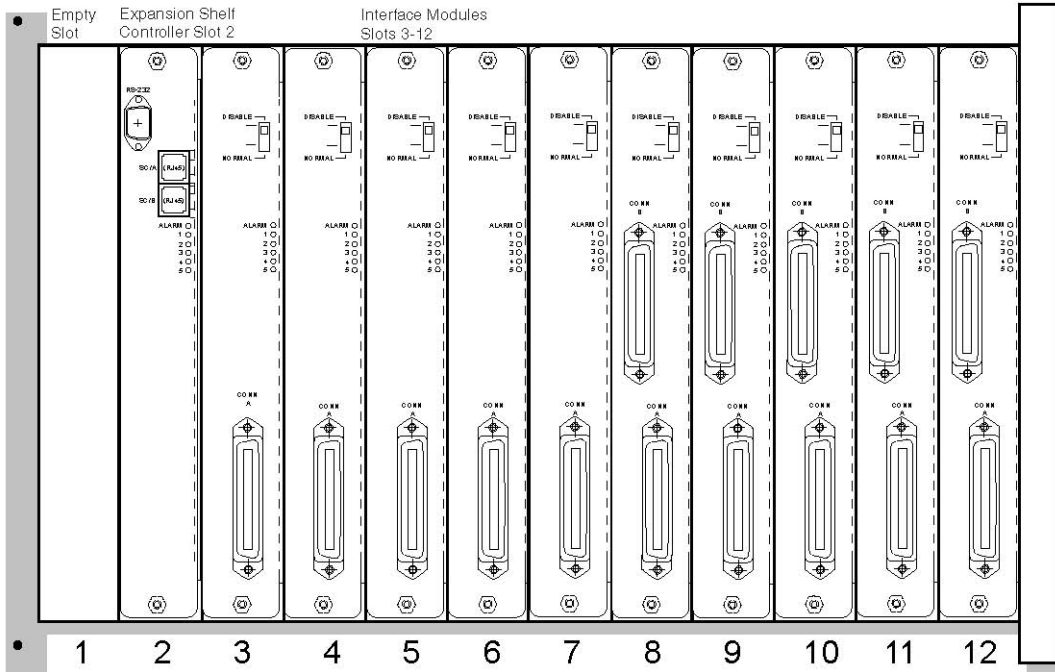

Fully Loaded Expansion Shelf



Do not install any card in slot 1 of expansion shelves

Connect the Intershelf Junction Panel

The Intershelf Junction Panel converts the RJ-21 connections on the system controller to the RJ-45 connections on the expansion shelf controller.

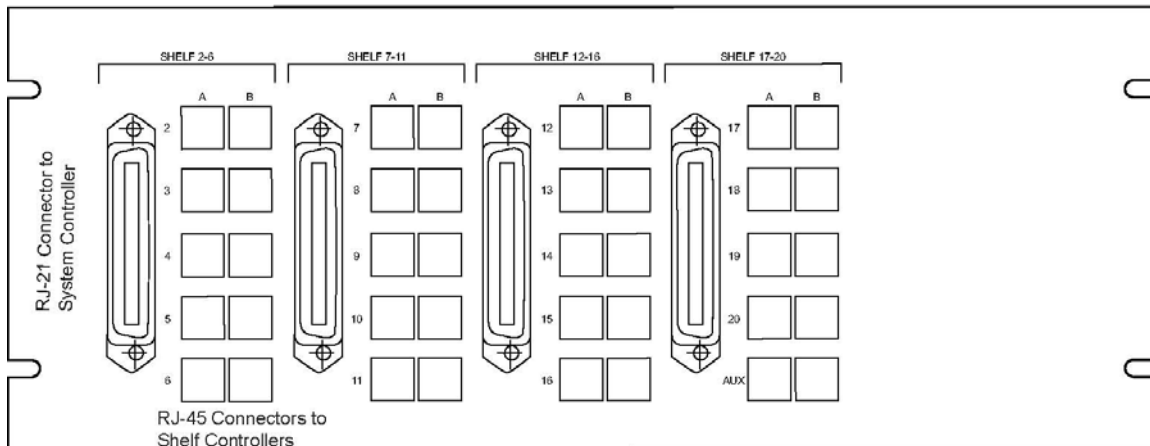

Intershelf Junction Panel (JPI300)

To connect the Intershelf Junction Panel:

1. Connect a five-foot RJ-21 cable from the CSC306 or CSC320 System Controller Card to the corresponding connection on the JPI300.
2. Connect two 12-foot RJ-45 cables from the Expansion Shelf Controllers (CSC300) to the corresponding shelf on the JPI300. Be sure the RJ-45 cable in Connector **A** on the Shelf Controller goes to the **A** Connector on the JPI300, and that Connector **B** goes to the **B** Connector.

Connect Demarc Block RJ-21 Cables to Interface Module

Connect the male RJ-21 connector from the appropriate demarcation block to the designated RJ-21 connector (**A** or **B**) on each Interface Module. Secure the cables using the keeper. Dress the cables by wire wrapping the cable at the rear of the shelf.



Do not connect these cables to the system controller or the system controller will be damaged.

Install Base Stations

Be sure the Base Station is positioned clear of anything that might damage it. The Base Station should be well above head height, away from doors and other objects that might strike it, and away from areas open to the elements or possible water leaks.

Check the location for other radio antenna devices and place the Base Stations to avoid interference. Leave enough slack wire to account for possible future Base Station moves.

Mount Base Stations on Dropped Tile Ceilings

A ceiling clip and plastic bolt are supplied to install Base Stations on the drop ceiling rails (T-bars) used to support acoustical tile. The plastic bolt screws into the top of the Base Station, then snaps into the ceiling clip which has been attached to the rails that hold the acoustical tile. The fastener is designed for use on 15/16" wide rails.

1. Attach the metal fastener to the rail (T-bar) supporting the dropped ceiling by rotating it into position until it snaps into the locked position.
2. Screw the plastic bolt to the 1/4" x 20 captive nut into the top of the Base Station.
3. Slide the bolt into the exposed prongs of the metal clip until it snaps into position.

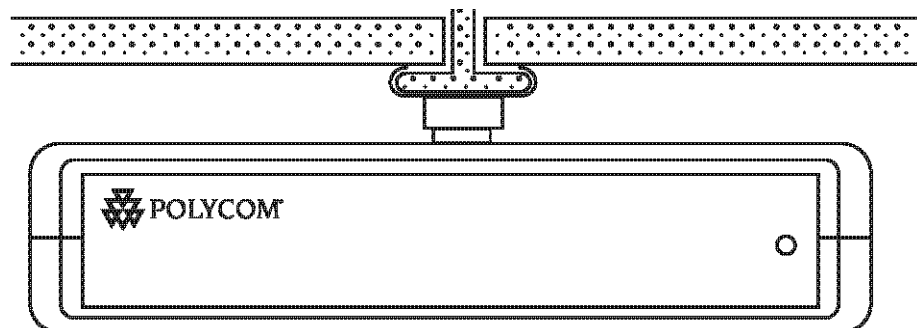

4. When properly attached the Base Station should sit almost flush against the ceiling and be tightly attached to the clip and T-bar grid work.
5. Once the Base Station is anchored to the fastener, lift the acoustical tile and plug the RJ-45 8-pin modular plug into the connector on the top of the Base Station.
 - The LED will blink red and green as the system software downloads to the Base Station and the Base Station is tested.
 - When the LED blinks amber, the system is ready for operation.
 - When the LED blinks green, a handset has established a radio link with that Base Station.
 - If the LED turns solid red or other red/green sequence, refer to *SpectraLink 6300 MCU Maintenance and Diagnostics*.

Mount Base Stations on Finished Ceilings

If this site does not have a dropped tile ceiling, the Base Station can be mounted to a finished ceiling or wall with a 4 to 5" long 1/4" -20 TPI plastic or nylon screw or bolt (such as a lag screw).



The customer's wire contractor is responsible for this installation.

1. Drill two holes approximately 1" apart. Make the holes large enough to accommodate the RJ-45 connector and a bolt to secure the Base Station.
2. Insert a wide washer above the ceiling, then screw the bolt into the beam or ceiling.
3. Insert three nuts on the bolt, then screw the Base Station into the bolt, being careful not to insert the bolt more than 1/3", five full turns, into the Base Station.

If the ceiling is open with I-beams or pipe construction, mount the Base Station with I-beam clamps or pipe clamps.

Install Outdoor Base Stations

Outdoor Base Stations (RCO400) are equipped with a protective enclosure, designed to be mounted to a wall or pole. After the enclosure is mounted, the Base Station is inserted in the enclosure and connected.

The customer's wire contractor is responsible for wiring and mounting the outdoor Base Station enclosure. The contractor is responsible for supplying screws, brackets, and other appropriate hardware.



If the wiring between the MCS300 and the telephone system leaves the building, consult the telephone system manual, the NEC, and local codes for instructions on providing lightning and other over-current protection.

Wire outdoor Base Stations

If the wiring for a Base Station exits a building – whether to reach an outdoor Base Station location or to reach a Base Station in another building – it should be equipped with primary protection according to the NEC and/or local codes.



Wiring that exits the building must also be protected at both ends by a Quick Clip Fuse from Reliable Electric, part number RSCP-2. Insert the Quick Clip fuses in place of bridging clips on a 66 block for the non-internal Base Station circuits.

Mount and connect outdoor Base Stations

1. Mount the outdoor Base Station enclosure to a wall or pole. The enclosure should be attached at the highest point available that will provide central coverage for the outdoor area.
2. Insert the Base Station wire through the compression fitting and tighten the fitting.
3. Wire the Base Station connector the same way as the RJ-45 connectors for the indoor Base Stations.
4. Place the Base Station inside the enclosure with the part number label facing the back of the enclosure.

5. Screw the protective cover onto the Base Station enclosure.

Power Up and Check Diagnostics

Turn the power switch in the upper left of the Primary and Expansion Shelves on.

After a slight delay, the lights on the cards will cycle through diagnostic tests.

After testing completes, lamp 1 should flash green, indicating that the card is running. If the Alarm light is red, there is a problem with the system. Refer to *SpectraLink 6300 MCU: Maintenance and Diagnostics* for troubleshooting information.

System Initialization

Before the system can be tested or operated, the administration and maintenance PC must be installed and connected to the MCU, the system must be configured, and the handsets and Base Stations must be registered. Refer to the *SpectraLink 6300 MCU: Operator's Console* document to perform the following steps, then return to the next section to continue the installation procedures.

1. The PC must be connected to the system controller's RS-232 serial port. An optional modem should also be connected to a dedicated phone line to provide remote access.
2. Load the administration software (Chk3000) and run the software.
3. Configure all system parameters.
4. Register all handsets.
5. Register all Base Stations.
6. Program macros on systems with analog interface.
7. Program handset features on the PBX.

If the system is connected to the telephone system via analog lines, refer to the *SpectraLink 6300 MCU: Operator's Console* documentation.

If the SpectraLink 6300 MCU is connected to a digital key telephone system or PBX, refer to the section of the *LinkPlus Interface Guide* that deals specifically with the brand of telephone system to which the SpectraLink 6000 System will interface.

Test System

The system should now be tested to ensure that it is functioning correctly. Power cycle the system. Verify that all Base Stations download and go to a running status. This takes about 30 seconds after connecting the Base Station cable to the Base Station's RJ-45 socket. During this period the Base Station's LED will flash in several sequences. At the end of this period the LED will be flashing yellow.

Test each Base Station:

While standing near the Base Station, use a registered handset and go off-hook. Verify a clear dial tone. The Base Station's LED should flash green.

Verify proper registration and operation of each handset by performing the following test:

1. Press the **START** key on each handset. The extension number should clear and you should hear dial tone. On some digital systems, depending on how the telephone system is programmed, you may have to select a line to get dial tone.
2. Place a call to each handset to verify ring, answer, clear transmit, and clear receive audio.
3. Verify all programmed features on each handset.
4. Press the **END** key. The line indicator should turn off.

Voice-test each Base Station

Walk around the installation site with a handset while making voice calls to a deskset. Verify that both ends of the conversation are of good quality on each Base Station.

Run Listen Verify Diagnostic

The Listen Verify diagnostic is used to determine if Base Stations are performing correctly. See *SpectraLink 6300 MCU: Operator's Console* for details. When the test is run, each Base Station stops transmitting for a short time and listens for other Base Stations. The system checks signal strength levels between Base Stations to ensure that no Base Station is installed too close to another. If Base Stations are too close, one Base Station will be disabled ("locked out") and an alarm will be activated, unless the Base Station in question has been designated as an "isolated" Base Station.

Base Stations with diagnostic listen values of less than -40 dbm are close to being locked out. If the Base Station is only a few dbm away from locking out, it should be repositioned to get a lower signal strength to avoid the lockout.

The Listen Verify test can be run manually or the system can automatically run it at the same time each day. See *SpectraLink 6300 MCU: Operator's Console* for detailed information on how to manually or automatically run the Listen Verify diagnostic, and how to interpret results.

Site Certification

The Polycom field service engineer should not leave the site before contacting Polycom to perform remote install verification.

The field service engineer should contact a Polycom engineer on the technical support line at 800-775-5330. The hours of operation are 6 a.m. to 6 p.m. Mountain time, Monday through Friday.

Before leaving the installation site, the field service engineer must complete the following items:

- From the Operator's Console, copy the PCS.CFG file to diskette. From the Operator's Console, press F1 (Supervisor State Display) then select **Dump Config to PCS.CFG**. See *SpectraLink 6300 MCU: Operator's Console* Chapter 5, section *Dump Config to Disk* for more information.
- Give the system administrator a map of the system showing the final Base Station locations.
- Perform end-user training.
- Perform administrative training and get a signature on the acceptance document. This document confirms that the installation has been correctly carried out, that the coverage area is correct, and that the client's personnel have been trained.

The installation is not complete until all certification steps have been performed. SpectraLink 6000 Wireless Telephones should not be handed out until the site has been certified.

Installation Forms

This section contains the following forms:

- Site Preparation Checklist
- Base Station Location Worksheet
- Extension Assignments Worksheet
- Customer Acceptance Form

Copy these forms as needed. Be sure to maintain completed forms for future reference.

Site Preparation Checklist

If upon arrival the Polycom field service engineer determines that the pre-installation work has not been completed correctly, the engineer has two options: 1) the engineer can leave the site and reschedule the installation when the action items have been completed or corrected, or 2) the engineer can assist in preparing the site, and thus spend additional time installing the system. Because of the additional cost incurred by Polycom in executing either option, the customer will be billed for the additional time at the standard hourly rate plus expenses.

Please be sure the following items are completed.

- MCU location prepared. Typically the MCU is installed in the telephone equipment room. This location must have sufficient rack or backboard space and power available.
- Two-pair wires are run to each of the Base Station locations as designated on the building floor plans. Use Level 3 cable for lengths up to 3,500 feet; Level 4 for lengths up to 6,000 feet.
- The Base Station cables are terminated with RJ-45 crimp-on plugs at the designated locations.
- One (or two) cross-connect block(s) are installed for every Interface Module and connected with a 25-pair Telco cable terminated with an RJ-21 male connector at the MCU location.

- The Base Station cables are terminated at the appropriate cross-connect blocks.
- Analog or digital ports, one per handset, from the switch are terminated at the appropriate cross-connect block and the block is labeled with the extensions.
- A dedicated dial line (MB) is available with an RJ-11 jack for the diagnostic modem.
- An IBM-compatible PC is available to serve as the Operator's Console for system administration.
- A system administrator is designated for the SpectraLink system. This person should be present for the installation. The Polycom field service engineer will provide system training to the system administrator on the day following the installation.

**When this checklist is completed please sign, date, and fax to
Install Coordination at 303-449-7016.**

Signature: _____

Date: _____

If you have any questions regarding the installation procedure, please call the Polycom Customer Support Hotline at 800 775-5330 (Monday through Friday, 6 a.m. to 6 p.m. Mountain time).

Base Station Location Worksheet

Shelf Number: _____ Interface Module: _____

Base Station #	Location (e.g.: building, floor #, detailed description)	Interface Module Circuit #
Base Station 1		1
Base Station 2		2
Base Station 3		3
Base Station 4		4
Base Station 5		5
Base Station 6		6

Shelf Number: _____ Interface Module: _____

Base Station #	Location (e.g.: building, floor #, detailed description)	Interface Module Circuit #
Base Station 1		1
Base Station 2		2
Base Station 3		3
Base Station 4		4
Base Station 5		5
Base Station 6		6

Shelf Number: _____ Interface Module: _____

Base Station #	Location (e.g.: building, floor #, detailed description)	Interface Module Circuit #
Base Station 1		1
Base Station 2		2
Base Station 3		3
Base Station 4		4
Base Station 5		5
Base Station 6		6

Extension Assignments Worksheet

Shelf: _____ Interface Module: _____

Handset #	Ext. #	Name	Interface Module Circuit #	Comment	Handset Serial #
Handset 1			1		
Handset 2			2		
Handset 3			3		
Handset 4			4		
Handset 5			5		
Handset 6			6		
Handset 7			7		
Handset 8			8		
Handset 9			9		
Handset 10			10		
Handset 11			11		
Handset 12			12		
Handset 13			13		
Handset 14			14		
Handset 15			15		
Handset 16			16		

Customer Acceptance Form

Customer Name: _____

Lease number (if applicable): _____

Schedule number (if applicable): _____

This document certifies that _____, acting as the representative of _____, accepts the installation of the SpectraLink Wireless Telephone System as set forth on schedule number _____ completed on _____, 200__.

A complete installation includes but is not limited to the following items:

1. The Master Control Unit (MCU) was installed.
2. All the Base Stations were installed.
3. Conversation was verified on all Base Stations.
4. Conversation was verified on all Wireless Telephones.
5. Hand-off was verified on all Base Stations.
6. Coverage was confirmed for the areas specified at time of facilities analysis.
7. Software was installed on customer's PC.
8. A facilities map of the areas of coverage was given to the customer.
9. Training class was given on use of Wireless Telephones.
10. Administrative training was given to at least one user.

The following additional parts that were not part of the original order were installed:

Item	Part #	Description & Serial Number	Qty
1			
2			
3			
4			
5			

The terms and conditions of original Quotation and Sales Agreement apply to all equipment listed above.

_____ I accept the installation of the SpectraLink system as complete.

_____ I decline the installation of the SpectraLink system because:

Customer Signature: _____

Date: _____

Customer Name (Printed): _____

Field Service Engineer Signature: _____

Date: _____

Safety Notices



WARNING: Changes or modifications to this equipment not approved by Polycom may cause this equipment to not comply with part 15 of the FCC rules and void the user's authority to operate this equipment.



WARNING: Polycom products contain no user-serviceable parts inside. Refer servicing to qualified service personnel.



IMPORTANT SAFETY INFORMATION

Follow these general precautions while installing telephone equipment:

- Never install telephone wiring during a lightning storm.
- Never install telephone jacks in wet locations unless the jack is specifically designed for wet locations.
- Never touch uninsulated telephone wires or terminals unless the telephone line has been disconnected at the network interface.
- Use caution when installing or modifying telephone lines
- When installing Base Stations outside or in buildings other than the one containing the System Controller, take the following precaution:
If wiring for a Base Station exits a building—whether to reach an outdoor Base Station location or to reach a Base Station in another building—the wiring must be protected at both ends by a Quick Clip Fuse from Illinois Tool Works, Linx Division, model number SCP-2X2. The Quick Clip Fuse replaces the bridging clips on the 66 blocks for all four connections to the non-internal Base Station.

Index

A

Attenuation.....27

B

Base Stations16
 Cabling26, 28
 High Density.....17
 Lockout values56
 Maximum distance from MCU23, 28
 Mounting.....49
 Outdoor51
 Test.....55
Battery Chargers40

C

Cabling29
 Base Stations26
 Demarcation blocks32
 Four-wire digital31
 Outdoor Base Stations51
 Outside33
 Two-wire analog or digital30
Cards, Electrostatic warning41, 44
ccLink17
Ceiling clip.....49
Cell.....*See* Base Station
Chargers.....40
Customer Acceptance Form.....63
Customer Support Hotline4

D

Demarcation blocks32
 Four-wire digital35
 Two-wire analog or digital34

E

Ethernet Port.....15
Expansion Shelf

 Controller15
 Installing.....45
Extension assignment worksheet62

F

Batteries.....40
Forms
 Customer Acceptance.....63
 Extension assignments62
 Site preparation checklist.....59

H

High Density Base Stations17
Hotline.....4

I

Icons.....4
Installation steps (chart).....9
Interface Module.....13
Interface Modules15
 Installing.....44
 Interface types29
Intershelf Junction Panel
 Connecting.....47
 Description.....16
 Installing.....42

L

Link 3000 MCU, description13
Link WTS
 System description.....11
 Topology13
Listen Verify Procedure56
Load balancing.....32
Lockout values56

M

MCU
 Description.....13

Location.....	22	S	
O		Shelves	
OAI		Description.....	15
Part Numbers	15	Installing.....	41
Ports	15	Mounting.....	23
System Controller Card.....	15	Site Certification.....	57
Open Application Interface	See OAI	Site preparation.....	19
Operator's Console		Site preparation checklist.....	59
Specifications	21	System administrator	21
Operator's Console	18	System Controller	
P		Description.....	15
Power		Installing.....	44
Clearance.....	24	T	
Connecting to Shelves	42	Testing the system	55
Controller	20	Traffic planning.....	32
MCU.....	26	U	
Pairs	27	Union labor.....	22
Shelf requirements	15	V	
Q		Voice test.....	55
Quick Clip Fuse.....	20	W	
R		Wall mounting	23
Rack mounting.....	23	Wireless Telephone	
Required materials.....	20	Description.....	17
RS-232 ports.....	15	Test.....	55

Free Manuals Download Website

<http://myh66.com>

<http://usermanuals.us>

<http://www.somanuals.com>

<http://www.4manuals.cc>

<http://www.manual-lib.com>

<http://www.404manual.com>

<http://www.luxmanual.com>

<http://aubethermostatmanual.com>

Golf course search by state

<http://golfingnear.com>

Email search by domain

<http://emailbydomain.com>

Auto manuals search

<http://auto.somanuals.com>

TV manuals search

<http://tv.somanuals.com>