



SpectraLink 8020/8030 Wireless Telephone

User Guide

with Session Initiation Protocol (SIP)

September 2010 Edition
1725-36165-001
Version G



Patent Information

The accompanying product is protected by one or more US and foreign patents and/or pending patent applications held by Polycom, Inc.

Copyright Notice

© 2008 to 2010, Polycom, Inc. All rights reserved. POLYCOM®, the Polycom "Triangles" logo and the names and marks associated with Polycom's products are trademarks and/or service marks of Polycom, Inc. and are registered and/or common law marks in the United States and various other countries. All other trademarks are property of their respective owners. No portion hereof may be reproduced or transmitted in any form or by any means, for any purpose other than the recipient's personal use, without the express written permission of Polycom.

All rights reserved under the International and pan-American copyright Conventions.

No part of this manual, or the software described herein, may be reproduced or transmitted in any form or by any means, or translated into another language or format, in whole or in part, without the express written permission of Polycom, Inc.

Do not remove (or allow any third party to remove) any product identification, copyright or other notices.

Every effort has been made to ensure that the information in this document is accurate. Polycom, Inc. is not responsible for printing or clerical errors. Information in this document is subject to change without notice and does not represent a commitment on the part of Polycom, Inc.

Notice

Polycom, Inc. has prepared this document for use by Polycom personnel and customers. The drawings and specifications contained herein are the property of Polycom and shall be neither reproduced in whole or in part without the prior written approval of Polycom, nor be implied to grant any license to make, use, or sell equipment manufactured in accordance herewith.

Polycom reserves the right to make changes in specifications and other information contained in this document without prior notice, and the reader should in all cases consult Polycom to determine whether any such changes have been made.

NO REPRESENTATION OR OTHER AFFIRMATION OF FACT CONTAINED IN THIS DOCUMENT INCLUDING BUT NOT LIMITED TO STATEMENTS REGARDING CAPACITY, RESPONSE-TIME PERFORMANCE, SUITABILITY FOR USE, OR PERFORMANCE OF PRODUCTS DESCRIBED HEREIN SHALL BE DEEMED TO BE A WARRANTY BY POLYCOM FOR ANY PURPOSE, OR GIVE RISE TO ANY LIABILITY OF POLYCOM WHATSOEVER.

Contact Information

Please contact your Polycom Authorized Reseller for assistance.

Polycom, Inc.
4750 Willow Road,
Pleasanton, CA 94588
<http://www.polycom.com>

About this Guide

Thank you for choosing the SpectraLink 8020/8030 Wireless Telephones with Session Initiation Protocol (SIP)¹. These handsets provide business telephony features and functions such as multiple call appearances, call hold, transfer, and conference over your Local Area Network. Your handset can call other telephone numbers and extensions within your facility as well as any external telephone number. Your handset will only work within your facility when it is in contact with the LAN. It will not work beyond the coverage area of the wireless LAN. Contact your system administrator if you have questions about your facility's boundaries.

In this User Guide, you will find everything you need to quickly use your new handset. If you have questions about features and functions customized for your facility, contact your system administrator. Please read the *Safety* section in this guide before you set up and use the SpectraLink 8020/8030 Wireless Telephone.

Polycom Model Numbers

This document covers the following registered model numbers:

802X (SpectraLink 8020 Wireless Telephone)

803X (SpectraLink 8030 Wireless Telephone)

PBP0850 (Standard Battery Pack)

PBP1300 (Extended Battery Pack)

PBP1850 (Ultra-Extended Battery Pack)

PCS1850 (Desktop Charger)

PCD1850 (Dual Charger)

PCQ1850 (Quad Charger)

¹ SIP is a Voice over IP (VoIP) signaling protocol used by the SpectraLink 8020/8030 Wireless Telephones to send and receive telephone calls over the computer system installed in your facility. Calls are routed and managed by a SIP "call server", sometimes referred to as the PBX.

Related Documents

SpectraLink 8020/8030 Wireless Telephone Administration Guide for SIP
(1725-36038-001)

SpectraLink 8020/8030 Regulatory Information
(1725-36084-001)

Available at

<http://www.polycom.com/support/voice/wi-fi/index.html>

Customer Support

Please contact your facility's Network Administrator for support.

You may also access the Polycom Knowledge Base at

<http://www.polycom.com/usa/en/support/voice/voice.html>

Icons and Conventions

This manual uses the following icons and conventions.



Caution! Follow these instructions carefully to avoid danger.



Note these instructions carefully.

Label

This typeface indicates a key, label, or button on SpectraLink hardware.

Contents

- 0 About this Guide..... 3**
 - Polycom Model Numbers.....3
 - Related Documents.....4
 - Customer Support.....4
 - Icons and Conventions.....4

- 1 Getting Started with your SpectraLink 8020/8030 Wireless Telephone 9**
 - Overview9
 - Battery Packs.....10
 - Features of your SpectraLink 8020/8030 Wireless Telephone ...12
 - The Handset Display14
 - System Icons15
 - Call Status Icons15
 - Softkeys.....16
 - NavOK Functions17
 - Menus18
 - Handset Modes20
 - Accessories22
 - Carrying Options22
 - Headsets22

- 2 Customizing your SpectraLink 8030/8030 Wireless Telephone 23**
 - Config Menu23

Lock Keys	27
Language	27
User Profiles.....	27
Phone Settings	30
Push-to-Talk (PTT).....	31
System Info.....	32

3 Using the Basic Features of your SpectraLink 8020/8030 Wireless Telephone 33

Turn the Handset On.....	34
Turn the Handset Off	34
Change the Language.....	34
Lock the Keypad	34
Unlock the Keypad	34
Place a Call	35
Place an Emergency Call.....	35
Answer or Reject a Call.....	36
Place a Call on Hold	37
Answer a Second Call.....	37
Resume a Call on Hold from Standby	38
Navigate among Call Tabs.....	38
Forward Calls	38
Clear Forwarding on a Line.....	39
Do Not Disturb (reject all incoming calls)	39
Clear Do Not Disturb	39
Redial the Last Number you Dialed.....	39
Silence the Ringing	40
Change the Ring Volume.....	40
Adjust the Speaker Volume.....	40
Adjust the Headset Volume	40

Mute/Unmute a Call.....	40
End a Call	40
Change the Profile.....	41
Open the Config Menu.....	41
Turn on the Backlight	41
4 Using the Advanced Features of your SpectraLink 8020/8030 Wireless Telephone	43
Place a Second Call	43
Place a Call on a Different Line.....	44
Place a Call from Favorites Menu.....	44
Answer a Call on a Second Line	44
Use Call Logs	45
Transfer a Call (blind)	47
Transfer a Call (consulted).....	47
Transfer an Active Call to a Call on Hold	48
Listen to Voicemail	48
Activate Installed Custom Applications.....	48
Use the Phonebook and Speed Dial	49
5 Using the Push-to-Talk Features of your SpectraLink 8030 Wireless Telephone	53
Make a PTT Call.....	54
Respond to a PTT Call.....	54
End a Wait Period	54
Select a Different PTT Channel	54
End One PTT Call and Start another on a Different Channel.....	54
Receive a PTT Call while on a Telephone Call	54
Use PTT Vibrate	55
Transmit on the Priority Channel	55

End a PTT Call.....	55
Change the PTT Volume.....	55
Answer a Telephone Call during a PTT Transmission	55
Start a Telephone Call during a PTT Transmission	55
Turn off PTT.....	56
Subscribe to additional PTT channels.....	56
6 Charger Options.....	57
Charger Models.....	57
Charging Status Indicators	58
Single Charger	59
Dual Charger	60
Quad Charger.....	61
7 Cleaning and Drying the Handset.....	63
8 Safety Information	67
9 Index.....	73

Getting Started with your SpectraLink 8020/8030 Wireless Telephone

Overview

The SpectraLink 8020/8030 Wireless Telephone is a mobile handset that uses a call server (sometimes referred to as the PBX) and the Local Area Network (LAN) to connect to other telephones at your workplace and on the public telephone system. The handset gives you the freedom to roam throughout the workplace while providing all the features and functionality of a SIP desk phone.

The handsets will only work when they are within range of the wireless access points at your facility; they are not cellular or satellite phones.



Install and charge the Battery Pack before using the SpectraLink 8020/8030 Wireless Telephone. See the Battery Packs section below and Chapter 5 Charger Options.

Battery Packs

Three battery pack models are available: Standard, Extended, and Ultra-Extended. The Standard Nickel Metal Hydride (NiMH) rechargeable handset Battery Pack gives you approximately four hours of talk time or 80 hours of stand-by time. Stand-by time is when the handset is turned on, but not in an active call.

Type	Talk Time	Standby Time	Charging Time
Standard	4 hours	80 hours	2 hours
Extended	6 hours	120 hours	3 hours
Ultra-Extended	8 hours	160 hours	4 hours



The type of Battery Pack is printed on the label. Remove the Battery Pack and view the label to determine the type of Battery Pack you have been issued.



Use only Battery Pack models BPL100, -200 and -300 in the SpectraLink 8020/8030 Wireless Telephones.

Indications of low battery

The handset will need to have its Battery Pack recharged periodically. The Battery Pack icon on the handset display's status row indicates the amount of charge remaining. Additionally the handset will sound warning tones and display the **Battery Low** message when there are fewer than two minutes of talk time remaining.

A melody will play when the handset is powered on for the first time after being fully charged, unless this feature has been disabled. Each Battery Pack type has a different melody. See your system administrator if you have questions about the type of Battery Pack you have been issued.

When the handset is in Standby mode, the message **Battery Low** and a series of chirps indicate a critically low Battery Pack charge. The handset will not work until the Battery Pack is charged.



Take care not to short the battery contacts on the Battery Pack with metal objects such as coins, keys or paper clips. Shorting the contacts can cause permanent damage.

Battery Pack removal and replacement

To remove, press down on the latch on the Battery Pack on the back of the handset. The Battery Pack releases outward.

To replace, slide the lip of the Battery Pack into the bottom of the cavity. Push the top of the Battery Pack until it snaps into place. You should not have to force it against the handset.

Notes on Battery Packs

- Battery Pack life will vary depending on handset model and features and system infrastructure.
- Maximum Battery Pack performance is achieved after a few charge/discharge cycles.
- If multiple Battery Packs are supplied with your handset, Polycom recommends that each be fully charged upon receipt to prolong battery life. Battery Packs will slowly lose charge if unused. To maintain battery potential, charge unused Battery Packs occasionally or alternate Battery Pack use.
- After a length of time Battery Packs will lose the ability to maintain a charge and to perform at maximum capacity and will need to be replaced. This is normal for all batteries.
- If your Battery Pack requires replacement, contact your system administrator.
- Overnight charging is best done while the handset is turned off.
- If the handset does not charge, clean Battery Pack, charger and handset contacts with an alcohol swab.
- When the handset is properly seated, the backlight comes on briefly and the handset beeps to indicate that charging has begun.
- Any battery which exhibits swelling, cracking or other abnormality should be disposed of promptly and properly.



Only use SpectraLink Battery Packs with SpectraLink 8020/8030 Wireless Telephones.

Features of your SpectraLink 8020/8030 Wireless Telephone

The handset operates much like a cell phone, and is programmed by your system administrator to support the features commonly available in an office environment. Orient yourself to your handset's features using the illustration below and the following explanatory material.

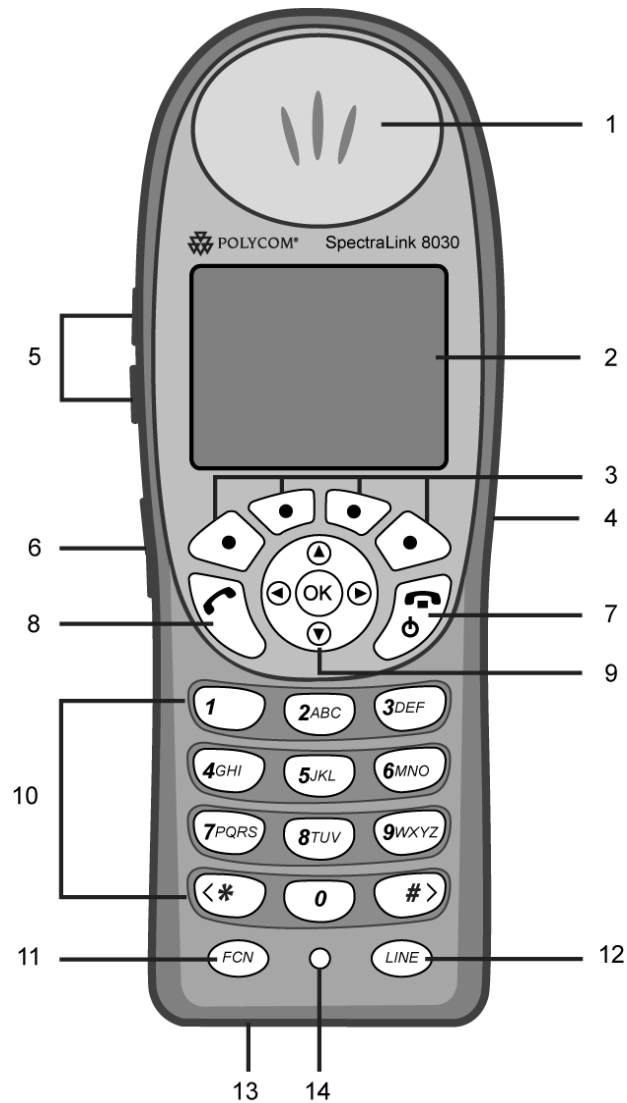

1. Earpiece – Delivers audio to the ear.
2. Screen – Displays information relating to the handset's current mode. See *Handset Modes* below.
3. Softkeys – Four softkey buttons. A softkey label appears in the display area just above the corresponding softkey when the function assigned to that softkey is available.
4. Headset jack – Allows you to place and receive calls through a SpectraLink headset.
5. Up/Down buttons – Use these buttons to scroll through displayed menu options. Use to adjust speaker volume while in a call.
6. Emergency Dial/TALK button – SpectraLink 8030 only. This button may be programmed by the system administrator for either Emergency Dial or Push-to-talk (PTT) functionality. Test the active mode by pressing the button once to see which feature is active. If you are prompted to press it twice to place an emergency call, then Emergency Dial is programmed. Check the **Config** menu to determine if PTT is activated. Push and hold to activate push-to-talk mode.
7. On hook – Also referred to as **END**. Use to power on and power off the handset, and to end a call.
8. Off hook – Also referred to as **START**. Use to obtain a dial tone or place a call.
9. Nav and Nav OK keys – Four directional navigation keys and a **NavOK** key. Use the Nav ◀▶ and ▲▼ keys for menu navigation. Use the **NavOK** key to select menu items, place calls, and perform softkey functions as described below in *NavOK functions*.
10. Keypad – 12 keys provide the 10 digits 0-9, the alphabetic characters, and special characters available in context-sensitive applications.
11. FCN – Press to access the Function menu; press in combination with assigned keys to access programmed system functions.
12. LINE – Press to access additional line appearances.
13. Battery contacts – Located along the bottom edge, the battery contacts enable the handset to be charged in the Desktop Charger or the Dual Charger. They should be kept clean and free of debris.
14. Microphone – Sensitive microphone transmits voice accurately and without distortion.

The Handset Display

When first powered on, the handset screen will display the standby screen. This screen displays a top row of system icons showing the status of the handset, followed by two lines for the handset's extension number and name, a line for date and time display, and a bottom row for softkey labels.



While the handset is in use, display screens include:

- Call status screen
- Push-to-talk screen (8030 only, if available)
- Message screen (if available)
- Menu screens.

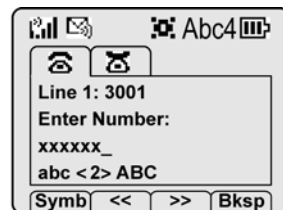
The call status screen has the following format:



This example shows:

- System icons (see table on next page)
- Call tabs (A call tab appears for each call in progress.)
 - Two call tabs indicate that two calls are in progress.
 - The call status icon  for the active call indicates that this call is being dialed.
 - The call status icon  for the pending call tab to the right indicates that call is on hold.
- First row text – the active call is on line 1, extension 3001
- **Enter Number** – the handset is ready to be dialed
- Dialed number (xxxx) – once this call is connected, the connected party's information will appear here
- Fourth row display – help or error messages, as appropriate
- Softkeys offering text editing functions (see table below)



System Icons

Indicator	Function
	The signal strength icon indicates the strength of the signal and can assist the user in determining if the handset is moving out-of-range.
	The battery icon indicates the amount of charge remaining in the Battery Pack. When only one level remains, the Battery Pack needs to be charged.
	The missed call icon is displayed when a call is not answered. Such calls can be viewed in the Missed Log. It is active only when Call Logging has been enabled by the system administrator.
	The voicemail icon is activated when a new voicemail message is received if the feature is supported by the phone emulation.
	The speakerphone icon displays when the speakerphone is active.
	Up and down arrows are displayed when the menu has additional options above or below. Left or right arrows are displayed during editing when the cursor may be moved left or right.
	The location service icon indicates the Real-Time Location System (RTLS) is enabled.
Locked	Locked indicates that the keypad is locked to prevent accidental activation. Use the Unlk softkey plus the # key to unlock it.
[No Service message]	If warning tones are not disabled, an alarm will sound and a descriptive message displays when the handset cannot receive or place calls. You may be outside of the covered area. Walk back into the covered area. The in-service tone indicates service is reestablished.
	The download icon indicates that the handset is downloading code. This icon only appears while the handset is running the over-the-air downloader. It appears to the right of the signal strength icon in the same location as the voicemail icon.
	The download failure icon indicates that the handset has failed to download code because the code is incompatible with the handset hardware. Contact your system administrator should this icon appear.
MUTED	The muted icon indicates the current call is locally muted.
XXXX	During character entry, indicates current data entry symbol mode.





Call Status Icons

Indicator	Function
	On-hook icon, Solid when in standby mode to indicate that at least one call is still active or on hold. Flashing when incoming call is ringing.
	Off-hook icon. Solid when a call is being dialed.
	Hold icon. Call is on hold.
	Transfer icon. Call is in the process of being transferred.
	Audio flowing icon (flashing). Audio is flowing both ways on a call.

Indicator Function

-  Audio receive-only icon (flashing). Locally muted or far end hold with no music on hold.
-  No audio icon. No audio is flowing. Call is terminating or far end hold with audio disable.

Softkeys

Softkey	Name	Displayed during...	Press to...
<<	Cursor backward	Entering a dial number.	Move the cursor back one position.
>>	Cursor forward	Entering a dial number.	Move the cursor forward in alphanumeric mode. If the cursor is at the end of the line, adds a space character.
Answ	Answer	Incoming call on the selected line.	Answer the call (equivalent to START key).
Bksp	Backspace character	Entering a dial number.	Delete the character prior to the cursor position.
Back	Back one screen	Displaying a menu.	Exit the menu, move back one screen.
Dial	Dial Call	A dial number is being entered on the selected line.	Initiate a phone call to the entered dial number.
End	End Call	An active call on the selected line.	Terminate the call without going back to standby mode.
Favr	Favorites	Prior to entering the first character of a dial number.	Activate the Favorites menu.
Fwd	Forwarding Definition	Prior to entering the first character of a dial number as a call forwarding destination.	Initiate definition of a new call forwarding destination. Delete a previously defined call forwarding destination.
Hold	Hold	In an active call.	Place the call on hold. The call status tab shows  when the call is on hold or  when audio is flowing.
Logs	Call Logs	Standby mode	Open the Call Log menu.
Msg ²	Message	Initial dial screen when new line is selected and a dial tone is active prior to entering first character of the number to be dialed.	Initiate a call to the specified message center contact address for retrieval or administration of voicemail.
Mute	Toggle muting	In an active call.	Toggle audio transmission to the far end. The call status tab shows  when not muted or  when muted.

² Appears only if the PROXYn_MAIL_NOTIFY is configured. A message center contact address must be defined for the proxy used by the selected line.

Softkey	Name	Displayed during...	Press to...
OK	OK	Power up registration if username is not configured in admin menu.	Send the username and password to the SIP server for authorization to register the handset.
Redl	Redial	Prior to entering the first character of a dial number.	Redial the last number that was dialed.
Rej	Reject	Incoming call on the selected line.	Reject the incoming call. The SIP server will then redirect the call elsewhere, such as voicemail.
Resm	Resume	In an active call and you have placed the call on hold, or in standby mode if any call is on hold.	Resume a call that was previously placed on hold or that went on hold when another line was activated.
Save	Save	Entering a dial number as a call forwarding destination.	Save the dial number as the call forwarding destination for the selected line.
Symb	Symbols	Entering a username or password. Entering the digits of a number.	Select the set of symbols available on the keypad while entering data.

NavOK Functions

The NavOK key acts as a fifth softkey with implicit functionality as follows:

State	NavOK key function
Dialing	Place a phone call.
Answering	Answer a phone call
Holding	Resume audio.
Displaying menu	Select the highlighted menu option.
Displaying call status	Connect audio on the currently selected call and place any previous call on hold.
Entering login name or login password	Save name or password and proceed with startup.

Menus

Line menu

The Line menu allows you to activate a call on a selected line or to view the status of lines.

Press the **LINE** key to display a menu of available lines and to activate a new call on a selected line.

The currently selected line is indicated by an asterisk (*). Lines which have new voicemail are flagged with plus (+) characters. The proxy server IP address is displayed on the info line. Lines that should be registered but have failed registration for any reason are displayed in faded text and are not selectable from the menu.

Exit the Line menu display by pressing a line number key to start a new call on the selected line and put any other call on hold, or by pressing the **END** key to exit without starting a new call. Press the **More** softkey to page through additional items on the Line menu.

Favorites menu

The Favorites menu assists you in dialing by providing access to a predefined list of dial numbers. The predefined list can include either complete dial numbers for named parties or partial numbers that need additional data entry. This might be the case, for example, if a PBX feature access code for call forwarding is defined in the favorites list but you need to add the forwarding destination information before sending the call to the call server to activate the feature.

While in active mode, press the **Favr** softkey to display a menu of predefined numbers or names that can be dialed (as programmed in the SIP TFTP configuration file.) When an item is selected from the list, the dial number is displayed. You may edit or add digits to the displayed number if necessary before pressing the **NavOK** key or **START** to place the call. When using the Favorites menu to perform a blind transfer to someone on the list, scroll to the entry on the Favorites menu, press **FCN** and select **Transfer**.

Symbol menu

The Symbol menu allows you to change the set of characters available for data entry through multiple key presses of the dial pad keys.

While dialing a number or entering login information, press the **Symb** softkey to view a menu of possible sets of characters that can be

entered using multiple key presses. Normally, a simple numeric mode is selected; selecting other symbol modes allows convenient access to the complete printable US ASCII character set. The following table shows what characters are available through repeated key presses in various symbol modes.

Key	Numeric	Alpha-Numeric	Numeric-Alpha	Punctuation
1	1	1 ; : / \ ! ' `	1	@ : 1
2	2	a b c 2 A B C	2 A B C a b c	; , 2
3	3	d e f 3 D E F	3 D E F d e f	& ` ~ 3
4	4	g h i 4 G H I	4 G H I g h i	() 4
5	5	j k l 5 J K L	5 J K L j k l	< > 5
6	6	m n o 6 M N O	6 M N O m n o	{ } 6
7	7	p q r s 7 P Q R S	7 P Q R S p q r s	[] 7
8	8	t u v 8 T U V	8 T U V t u v	' " \ 8
9	9	w x y z 9 W X Y Z	9 W X Y Z w x y z	^ _ 9
0	0	@ - _ 0 = , < >	0 - _	[space] 0
*	. *	. \$ * & % + ()	* .	* . = + / -
#	@ *	[space] , ()	# # [space]	# ! ? \$ %

FCN menu

The FCN menu is accessible while in the active mode and provides these features:

Transfer

Do Not Disturb

Set/Clear Forward

<custom application 1>

<custom application 2>

<custom application 3>

Items on this menu are accessible through the Nav ▲▼ keys or through shortcut keys as displayed with the menu items. Installed custom applications, such as messaging applications, are automatically added as items at the end of this menu when defined on an Open Applications Interface (OAI) server. If you have questions about the functionality of a custom application, contact your system administrator.

Handset Modes

Standby mode (on-hook)

In standby mode, the handset is powered on and is ready to send and receive calls. The extension number is shown on the display and there is no dial tone. In this mode, the handset is conserving battery power and bandwidth.

When an incoming call arrives, the handset rings and goes into active mode. Answer the call by pressing the **START** key, the **Answ** softkey or **NavOK**. The handset will ring according to user preference as specified in the standby menus. You can silence the ringing by pressing the **END** key. If you do not wish to accept the call, press the **Rej** softkey. The call will be redirected to voicemail if available.

Active mode (off-hook)

The handset is in the active mode when you are placing or receiving a call, or when the handset is in communication with the SIP server.

When an incoming call occurs during an active call, the handset will play the second call ringing sound until the call is answered, the caller hangs up, or the call transfers to voicemail. If you press the **END** key, the first (active) call ends and the handset reverts to a full ring for the second call.

The active mode utilizes the most bandwidth and battery power. To conserve these resources, return the handset to the standby mode at the end of your call by pressing the **END** key.

Push-to-talk (PTT) mode

The SpectraLink 8030 Wireless Telephones utilizes channels for incoming and outgoing radio communication, similar to a walkie-talkie. While using this feature, the handset is in PTT mode. It can receive regular phone calls while in this mode. When a regular phone call is answered, the handset switches to active mode.

Configuration menu mode

When user preferences are being configured in the Config menu, the handset is on, but is not active. It cannot receive calls while in the Config menu. The handset will revert to standby mode if there is no activity in configuration menu mode.

Message alert mode

If text messaging functions have been programmed, as in a nurse call system, the handset is able to receive text messages. While these messages are being accessed, the handset is in message alert mode. Incoming calls will ring with the second call ringing sound.

Accessories

Carrying devices and headsets that are specifically designed for your SpectraLink handset may be purchased through your service representative.

Carrying Options

The following options are available for handset protection and easy handset carrying and removal.

- Belt clip: Spring-loaded plastic belt clip that attaches to the back of the handset.
- Swivel belt clip: Swivel-style belt clip that attaches to the back of the handset with full 360 degree swivel or eight-position ratchet options.
- Swivel carrying case: Black leather case with keypad cover and swivel-style quick release belt clip.
- Holster: Black holster with belt clip.
- Cord lanyard: Nylon cord lanyard with quick disconnect.
- Coiled lanyard: Plastic coiled lanyard with clothing clip.

Headsets

Polycom offers optional headsets (for North America only) for use in noisy environments or if you need to have your hands free while talking on the handset.

To use the headset, simply plug it into the jack on the right side of the handset. While using a headset, the handset will ring according to the user profile setting established in the **Headset/Speaker** ring option. The external ring will ring according to the setting of the profile.

The headsets offered by Polycom have been laboratory tested and work properly with the SpectraLink 8020/8030 Wireless Telephone. Polycom does not recommend using other headsets.

Customizing your SpectraLink 8030/8030 Wireless Telephone

When the handset is in standby mode (on but not in use), press the **Cfg** softkey to display the configuration menu (“Config menu”). The handset cannot make or receive calls while in the Config menu. This menu allows you to set user preferences and display handset information.

Check with your system administrator for specific features supported by your handset.

Config Menu

Config menu	2nd level	3rd level	4th level	5th level	6th level
Lock Keys					
Language	*English Français Deutsch Español Italiano				
User Profiles	Silent Vibrate Loud Soft Custom	Set as Active	Ring Settings	Telephone Message Alert 1 Message Alert 2	Ring Cadence Off PBX Continuous Short Pulse Long Pulse Ring Tone Tones 1-10

Config menu	2nd level	3rd level	4th level	5th level	6th level	
	Silent Vibrate Loud Soft Custom			Ring Volume	Volume ■■■■■■■■	
				Vibrate Cadence	Off PBX Continuous Short Pulse Long Pulse	
					Ring Delay	No Delay 5 Second Delay 10 Second Delay
			Noise Mode	Normal High Severe		
			Ring in Headset Ring in Speaker			
			Warnings Enable/Disable			
			Key Tones Disable/Enable			
Phone Settings	Keypad Autolock	Disable 5 seconds 10 seconds 20 seconds				
	Display Contrast	Set Contrast				
	Use Hearing Aid Use No Hearing Aid					
	Startup Song Play/Inhibit					
	Predial Disable/Enable					

Config menu	2nd level	3rd level	4th level	5th level	6th level
Push-to-talk †	Default Channel	Channel 1 Channel 24			
	Subscribed Channels	Channel 1 Channel 2 Channel 3 Channel 24			
	PTT Audio Volume	Audio Volume ■■■■■■■■			
	PTT Tone Volume	Tone Volume ■■■■■■■■			
	PTT Vibrate Enable/Disable				
System Info	Phone IP Address				
	Alias IP Address				
	SVP IP Address				
	OAI IP Address				
	Firmware Version				
	Emergency Dial ‡	Emergency Number Emergency Name			

† (SpectraLink 8030 only) Push-to-talk must be enabled by the system administrator before it can be activated by the user. If it is not enabled, then it will not appear on the **Config** menu. If PTT has not been enabled, Emergency Dial may be. Check the **System Info** options to determine if **Emergency Dial** appears. If so, it is active.

‡ (SpectraLink 8030 only) **Emergency Dial** will appear if it has been enabled by the system administrator. The **Emergency Number/Name** options allow you to check the number and name that is dialed when the Emergency Dial button is pressed twice in two seconds.

Default settings

The profile options on the Config menu may be reset to their default values by the system administrator. These are the default settings:

Setting/profile	Silent	Vibrate	Soft	Loud	Custom
Language	English	English	English	English	English
Ring Cadence	Off	Off	PBX	PBX	PBX
Ring Tone	Tone 1	Tone 1	Tone 1	Tone 1	Tone 1
Ring Volume	1	1	3	7	5
Vibrate Cadence	Off	PBX	Off	Off	PBX
Ring Delay	0	0	0	0	5
Noise Mode	Normal	Normal	Normal	Normal	Normal
Headset/Speaker	Speaker	Speaker	Speaker	Speaker	Speaker
Key Tones	Off	Off	On	On	On
Warning Tones	Off	Off	Off	Off	Off
Push-to-talk *	Off	Off	On	On	On
PTT Vibrate †	Disabled	Disabled	Disabled	Disabled	Disabled
Emergency Dial ‡	On	On	On	On	On

* Push-to-talk must be enabled by the system administrator before it can be activated by the user. If it is not enabled, then it will not appear on the Config menu and will not be "On" for any profile.

† PTT Vibrate is available only when Push-to-talk has been enabled by the system administrator.

‡ Emergency Dial must be enabled by the system administrator. If enabled, it will be "On" (or available for use) in every profile.

Toggle options

Some menu items have only two options, which operate on a toggle basis. The current setting is shown below the menu heading on the info line. The other available setting is highlighted in the menu list. Press **NavOK** to activate the highlighted setting.

For example, when predial is disabled, the info line displays **Predial Disabled** and the highlighted menu item is the **Enable Predial** option. Press **NavOK** to enable predial. The info line will change to display **Predial Enabled**.

In another example, when the info line displays **Ring in Speaker**, the highlighted menu option is **Ring in Headset**. Press **NavOK** to select **Ring in Headset**. The ring will now sound in the headset and the info line will change to **Ring in Headset**.

Lock Keys

When enabled, the Keypad Lock option will lock the keypad immediately. If the keypad is locked, it may be unlocked by pressing the **Unlk** softkey and then the **#** key.

Language

The language used by the handset display may be changed by selecting one of the language options on the list. English is the default.

User Profiles

Your handset ring behavior is established by the five User Profiles: **Silent**, **Vibrate**, **Loud**, **Soft** and **Custom**. The currently-active user profile is shown on the standby display. If you want to quickly switch to a different profile, while in standby press the **Prof** softkey and select a different profile from the list. The currently-active profile is marked with an asterisk (*).

Set as Active

You can change to a different User Profile from the Config menu by selecting the desired profile and then selecting **Set as Active** and pressing the **NavOK** key. This activates the new User Profile.

Ring Settings

The Ring Settings option allows the user to set the ring for three separate functions. **Telephone Ring** is used for usual telephony functions. **Message Alert 1** and **Message Alert 2** may be used to set different ringing patterns for custom applications.

Telephone Ring

The telephone ring setting allows the user to set a distinctive ring rhythm, tone, volume and sequence. Select from an audible ring, a vibrate-only ring or a vibrate ring accompanied by an audible ring.

Ring Cadence The ring cadence is the rhythm of the ring. It may be set to a pre-programmed ring cadence, or it may be set to obtain its cadence from the SIP proxy server. The PBX option is designed to utilize any distinctive rings sent by the proxy server while allowing the user to set unique rings for auxiliary applications.

Off: Silent

PBX: The PBX, also known as the SIP call server, determines ring cadence (e.g. the call server may send rings that differentiate between internal and external calls)

Continuous: Rings continually until answered

Short Pulse: Rings in short bursts

Long Pulse: Rings in long bursts

Ring Tone Scroll and select from ten available tones. The **Play** softkey allows the user to preview the tone before selecting. If Ring Cadence is turned off, the Ring Tone option will not appear on the menu.

Ring Volume Use the **Nav** ◀ ▶ keys to change the Ring Volume setting, or press the up/down volume buttons on the side of the handset during ringing. If Ring Cadence is turned off, the Ring Volume option will not appear on the menu.

Vibrate Cadence Vibrate Cadence options are the same as for Ring Cadence (see above).

Ring Delay Ring Delay determines how long the vibrate cadence will play before the audible ring starts. If Ring Cadence is turned off, the Ring Delay option will not appear on the menu.

Message Alerts 1 and 2

Message Alerts are used by external applications such as nurse call systems. If such systems are installed in your facility, you may adjust

their ring characteristics to differentiate them from other rings. Contact your system administrator to find out if these options are available.

Noise Mode

Provides options that describe the noise level in your environment. Changing this mode to **High** or **Severe** adjusts the handset's microphone and in-ear speaker volume to account for background noise. Select **Normal** for most office environments; **High** for moderate background noise; or **Severe** for extremely noisy conditions. If you use **High** or **Severe** modes in a quiet environment, the person on the other end of the line may find it difficult to hear your voice.

High and **Severe** noise modes increase microphone, speaker, and ring volume settings above **Normal** mode baseline. All measures are approximate.

Noise mode	Microphone	In-ear speaker	Ring volume
High	+12dB	+6dB	+3dB
Severe	+18dB	+12dB	+6dB

Ring in Headset/Speaker

Toggle between the two options to select ring location.

Warning Tones

The handset plays various Warning Tones such as system up or down, out of range, etc. These tones may be turned on or off and are enabled by default.

Key Tones

Key Tones may be turned on or off and determine whether tones play when keys are pressed. Key Tones are enabled by default.

Phone Settings

Keypad Autolock

The handset may be set to lock the keypad automatically when in standby mode. The automatic locking function of the keypad may be disabled (the default) or adjusted for a 5, 10 or 20-second delay before locking.

Display Contrast

The display may need to be adjusted for different lighting situations. Contrast may be set by pressing the up/down buttons on the side of the handset or the **Nav** ◀ ▶ keys until the desired contrast is displayed.

Use Hearing Aid

The handset speaker may be set for use with a hearing aid. Toggle to set the desired option.

Startup Song Play/Inhibit

When the handset is powered up, a series of tones sounds. The Startup Song is enabled by default.

Predial

Enabling Predial allows the user to enter a phone number and then press the **START** key to initiate the call. If Predial is disabled in the **Config** menu, speed dial calls cannot be made from standby mode.

Predial must be enabled if you wish to use the **Redial** feature. See Chapter 3 *Using the Basic Features of Your SpectraLink 8020/8030 Wireless Telephone* for more information on using the **Redial** feature.

Push-to-Talk (PTT)



If the system administrator has configured the SpectraLink 8030 Wireless Telephones for PTT, they can be used like walkie-talkies. If the system administrator has disabled PTT, the PTT options will not appear in the Config menu.

Default Channel

Displays all enabled PTT channels. The default transmission channel is marked with a (*) to the left of the channel. If you wish to change the default PTT channel, use the **Nav ▲ ▼** keys to scroll to the desired channel and press **NavOK** to select it.

The handset will transmit only to phones set to receive on the selected channel. The Priority Channel transmits to all channels.

Subscribed Channels

Displays all enabled PTT channels. The handset will receive PTT transmissions on all subscribed channels, which are marked with a (*) to the left of the channel. The handset will not receive a PTT transmission on a channel to which the user has not subscribed. If you wish to select or deselect a subscribed channel, use the **Nav ▲ ▼** keys to scroll to the desired PTT channel and press **NavOK**.

PTT Audio Volume

Use the **Nav ◀ ▶** keys or the up/down volume buttons on the side of the handset to adjust the PTT Audio Volume setting.

PTT Tone Volume

Use the **Nav ◀ ▶** keys to adjust the PTT Tone Volume setting.

PTT Vibrate

To enhance the alerting of a PTT call, **PTT Vibrate** may be enabled. When **PTT Vibrate** is enabled, the handset will vibrate three times whenever a PTT broadcast is received, whether the handset is in standby or in a call. If in a call, the chirp alert will also sound. The vibration does not replace any PTT tone volume already set.

To set the handset for PTT vibrate only, enable **PTT Vibrate** and set the tone volume to zero.

System Info

Displays the IP address of the highlighted menu item. The IP address appears in the upper portion of the screen below the words **System Info**.

Phone IP Address

Displays the IP address currently assigned to the handset by the SVP Server.

Alias IP Address

Displays the IP address used by the call server to send communications to and from the handset via the SVP Server

SVP IP Address

Displays the IP address of the SVP Server.

OAI IP Address

Displays the IP address of the server used for custom applications when defined on an Open Applications Interface (OAI) Server.

Firmware Version

Displays the software version running the handset. The MAC address is the hardware identification number and is set at the factory. Three code numbers correspond to the three software files that each software version uses.

Emergency Dial

(SpectraLink 8030 Wireless Telephone only)

Emergency Dial will appear if it has been enabled by the system administrator. The **Emergency Number/Name** options allow you to check the number and name that is dialed when the Emergency Dial button is pressed.

Using the Basic Features of your SpectraLink 8020/8030 Wireless Telephone

Your SpectraLink 8020/8030 Wireless Telephone is designed to be used like a cell phone on a public switched telephone network (PSTN). You can place calls, transfer a call to someone else, or conduct a conference call.

Only one call is active at any given time. The active call has audio associated with it. There may be multiple other calls:

- On hold
- In an “Incoming call” or “Ringing” state

This chapter provides basic operating instructions for the SpectraLink 8020/8030 Wireless Telephone. This chapter contains instructions on how to:

- Turn the handset on and off
- Change the language
- Lock and unlock the keypad
- Place a call
- Place an emergency call
- Answer or reject a call
- Place a call on hold
- Answer a second call
- Resume a call on hold from standby
- Navigate among call tabs
- Set and clear Call Forwarding
- Set and clear Do Not Disturb
- Redial last number dialed
- Silence the ring

- Change the ring volume
- Adjust the speaker or headset volume
- Mute/unmute a call
- End the call
- Change the profile
- Open the Config menu
- Turn on the backlight

Turn the Handset On

Press and hold the **END** key until two chirps sound.

Turn the Handset Off

Press and hold the **END** key. One chirp will sound. If you are in a call, hang up first, then turn off the handset.

Change the Language

Press the **Cfg** softkey to open the **Config** menu and then select the **Language** option. Select the desired language and press **NavOK**.

Lock the Keypad

While in standby mode press the **Cfg** softkey, then press **NavOK**.

Unlock the Keypad

Press the **Unlk** softkey, then **#**.

Place a Call

1. To dial a number, follow any one of these sequences:
 - » Press the **START** key, wait for a dial tone, then dial the number. Then press either **START** again or **Nav OK**.
 - » Dial the number and then press the **START** key or **Nav OK**.
 - » Press the **Spkr** softkey, then dial the number. Then press either **START** again or **Nav OK**.
 - » Press the **Redl** softkey to redial the last number called.
 - » Press the **START** key; press the **Favr** softkey; use the **Nav ▲ ▼** keys to select the number or user from the list; press **Nav OK** to dial the number.
 - » Press **Logs**, select a call log and select the number you wish to call and then press **START** or the **Spkr** softkey. This option is locally enabled or disabled. See you system administrator if you need assistance.
2. Listen for the ring to indicate the alerting of the called party.

Note: **Line 1** is the default line

Example:

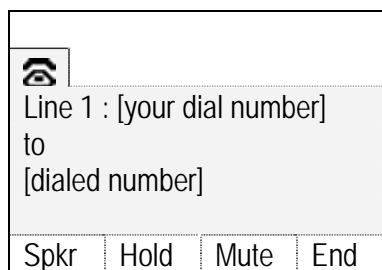

Place an Emergency Call

(SpectraLink 8030 Wireless Telephone only)



The large button on the left side of the SpectraLink 8030 Wireless Telephone may provide you with either Emergency Dial or PTT as determined and activated by the system administrator.

Press this button one time. If Emergency Dial is active, an explanatory message will be displayed.

When Emergency Dial has been enabled, the handset will dial an emergency number when it is pressed twice within two seconds. The number dialed may be found under the **Config Menu>System Info** option.



Caution! Emergency Dial will be inoperable if the wireless system or the call server fails for any reason. Do not rely on it as your sole method of emergency notification.

Answer or Reject a Call

When the handset rings, the line's icon  will flash. Row 1 will display the line number and your dial number. Row 2 will display **from**. Row 3 will display the caller ID of the incoming call.

Example:

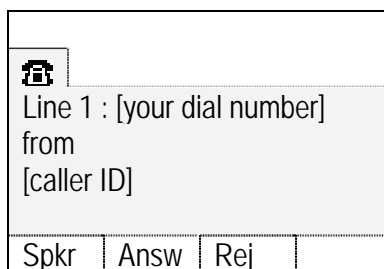

To answer a call:

- » Press the **START** key and hold the handset to your ear.
- » Press **NavOK** and hold the handset to your ear.
- » Press the **Answ** softkey and hold the handset to your ear.
- » Press the **Spkr** softkey and speak towards the handset.

When the call is answered, a flashing double arrow  displays on the call icon tab at the top of the display, indicating that this line is in an active call with established audio connection. The softkeys for **Hold**, **Mute** and **End** appear to the right of the **Spkr** softkey.

Example:

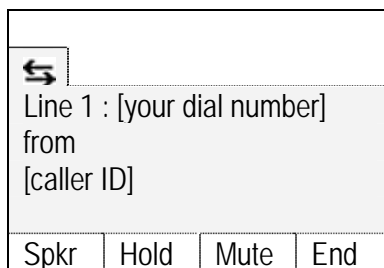

To reject a call:

- » Press the **Rej** softkey to reject the call and allow the SIP server to redirect the call elsewhere, usually to voicemail.

Place a Call on Hold

Press the **Hold** softkey.

When a call is placed on hold, the hold icon  appears and the **Resm** softkey displays.

Example:

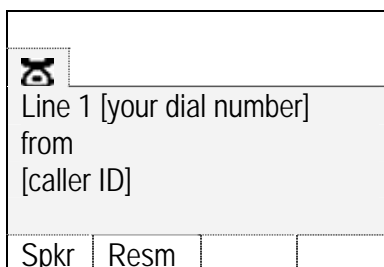

Answer a Second Call

When an incoming call occurs during an active call, the handset will play the second call ringing sound until:

- the call is answered
- the first call is terminated
- the caller hangs up or

- the call is transferred to voicemail.
1. Press the **Nav ▶** key to select the incoming call tab and view call details. (The original call's audio remains active.)

Example:

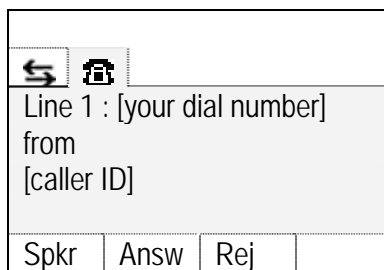

2. Press **NavOK**, **START**, **Spkr** or **Answ** to place the current call on hold and answer the second call, or
3. Press the **Rej** softkey to reject the incoming call.

Resume a Call on Hold from Standby

Press the **Resm** softkey. If more than one call is on hold, use the **Nav ◀▶** keys to select the call you wish to resume and press the **Resm** softkey or **NavOK**.

Navigate among Call Tabs

Use the **Nav ◀▶** keys.

Forward Calls

Calls may be forwarded on a per-line basis. The Line menu display will indicate if a line is forwarded by a > character followed by the destination address.

- When a line is forwarded, the standby screen displays the forwarding status, unless the do-not-disturb feature is enabled.
 - If your handset has multiple lines, set or clear forwarding for each line individually.
1. Press **START**, or press **LINE** and select the line number that you want to be forwarded.
 2. Press **FCN**.

3. Select the **Set/Clear Forward** option from the FCN menu by pressing key **3** or the **NavOK** key.
4. Enter the forwarding number for the indicated line.
5. Press **NavOK** to save.



If calls are forwarded through the wireless telephone and it goes out of range, is turned off or otherwise loses contact with the call server, call forwarding cannot be accomplished. Use a deskset to forward calls or do not turn off your handset.

Clear Forwarding on a Line

1. Press **START** or select the line number from the Line menu.
2. Press **FCN**.
3. Select the **Set/Clear Forward** item from the menu and press **NavOK**.

Do Not Disturb (reject all incoming calls)

1. Press **START**.
2. Press **FCN**.
3. Select the **Do Not Disturb** item from the menu and press **NavOK**.

When the do-not-disturb feature is enabled, the standby screen will display **Do Not Disturb**. The handset will not ring for new incoming calls.

Clear Do Not Disturb

1. Press **START**.
2. Press **FCN**.
3. Select the **Do Not Disturb** item from the menu and press **NavOK**.

Redial the Last Number you Dialed

1. Press **START**.
2. Press the **Redl** softkey.

3. Verify that the displayed number is the one you want and the line number is valid.
4. Press **NavOK** or **START**.

Silence the Ringing

Press the **END** key to silence the external speaker ring and convert to in-ear speaker ringing.

External speaker ringing will resume when the next incoming call is received while the handset is in standby mode.

Change the Ring Volume

Press the up/down volume buttons on the side of the handset during ringing, or while the handset is in standby mode.



Adjust the Speaker Volume

While speakerphone is active, press the up/down volume buttons on the side of the handset during the call.

Adjust the Headset Volume

While the headset is plugged in, press the up/down volume buttons on the side of the handset during the call.

Mute/Unmute a Call

Press the **Mute** softkey. When the handset is muted, the audio flowing icon  changes to the audio receive-only icon . Press the **Mute** softkey again to restore audio pickup.

End a Call

Press the **End** softkey to maintain the active mode and view the active calls. Press the **END** key on the keypad to return to the standby mode.

Normal Mode:

If the other party hangs up, the display will show **Press End Call**, along with a warning tone. If you do not hang up, the handset automatically hangs up after 5 seconds. At this time, the handset returns to idle mode and full ring volume.

Headset Mode or Speakerphone Mode:

If the other party hangs up and you do not press **END**, the handset will immediately hang up and return to idle mode.

Change the Profile

Press the **Prof** softkey and use the **Nav ▲ ▼** keys to select a new profile while in standby mode. The selected profile is marked with an asterisk (*).

Open the Config Menu

Press the **Cfg** softkey from standby mode.

Turn on the Backlight

The backlight comes on when any key is pressed or when there is an incoming call, and stays on for 60 seconds. It turns off if another key is not pressed within that period.

Using the Advanced Features of your SpectraLink 8020/8030 Wireless Telephone

This chapter provides operating instructions for the advanced features of the SpectraLink 8020/8030 Wireless Telephone.

This chapter contains instructions on:

- Place a second call
- Multiple line appearances
- Using the Favorites menu
- Transferring calls (blind and consulted)
- Listening to voicemail
- Activating installed custom applications

Place a Second Call

1. To get a dial tone for the second call, press **LINE** and **NavOK**.
 - a. If the handset has multiple lines, press **LINE** + [the line number].
 - b. Press **NavOK**.
 - The first call is automatically placed on hold.
 - The second call appears in a new call tab.
2. Dial the number to place the second call.
3. Use the **Nav** ◀ ▶ keys to toggle between calls.

Place a Call on a Different Line

1. Press the **LINE** key.
2. Navigate to the desired line and press **NavOK**.
3. Dial the number.
4. Press **START** or **NavOK** to initiate the call.

Place a Call from Favorites Menu

1. Press **START**.
2. Listen for dial tone.
3. Press the **Favr** softkey.
4. Use the **Nav ▲▼** keys to navigate to the desired entry.
5. Select the entry by pressing **NavOK**.
6. Press **START** or **NavOK** to place the call.

Answer a Call on a Second Line

If another call comes in on a different line, a new call icon flashes and a tone sounds in the audio stream.

Example:

In this example, a call is coming in on line 2 and the line 2 icon  is flashing.

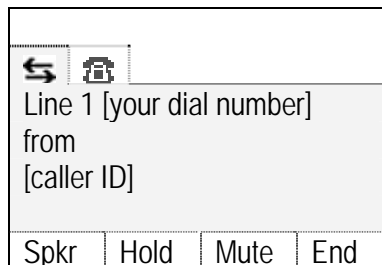

1. To view the caller ID of the incoming call without interrupting the active call, press **Nav ►**. The original call's audio remains active. The display now shows information about the incoming call.

Example:

			
Line 2 [your dial number]			
from			
[caller ID]			
Spkr	Answ	Rej	

2. Press **Answ** or **START** to answer the incoming call and place the active call on hold. Pressing the **Rej** softkey will redirect the incoming call to voicemail or as otherwise programmed.

Use Call Logs



Call Logs might not be available in your facility. If unavailable, the Logs softkey will not appear. Check with your system administrator for information about this feature.

Open a call log

Each log displays the 20 most recent calls by name, number and time with the most recent first.

1. In standby mode, press the **Logs** softkey. The following list of call logs will show:
 - **Outgoing** – calls dialed from this handset
 - **Missed** – incoming calls not answered.
 - **Answered** – incoming calls answered.
2. Use the **Nav** keys to highlight the log you want to view and press **NavOK**.
3. Use the softkeys to save or delete the selected number.



The information stored in a call log may differ from how a call is displayed when it is received. The handset will store calls according to a list that gives priority to how numbers are stored locally over information provided by a call server.

Call a number in the call log

Press **START** or the **Spkr** softkey to place a call.

If the call back feature is disabled, the **Spkr** softkey will not appear and the **START** key will not work to place a call from any call log. You must exit the call log and place the call as described above.

Save a number from a call log to the phonebook

1. Select the number from the log using Nav keys.
2. Press the **Save** softkey.
3. See instructions below for editing a phonebook entry.

The **Save** softkey will not be available if this number is already in the phonebook or if the phonebook is full. Only the number as it was received is ported over to the phonebook, the name will need to be manually entered. You must enter alphanumeric characters, not blank spaces. Note that the number may need to be edited with additional digits when saving **Missed** or **Answered** calls.

Delete a call from a call log

1. In the call log, select the call you wish to delete.
2. Press the **Del** softkey. A confirmation screen will prompt you to press a **Yes** or **No** softkey before the deletion is done.

View call details

1. Open the call log.
2. Select the call you wish to view and press **NavOK**. The **Call Details** screen appears:

The number may be saved to the phonebook or deleted using the **Save** and **Del** softkeys. If the number is already in the phonebook or if the phonebook is full, the **Save** softkey will not appear. Press **START** or the **Spkr** softkey to place a call. If the call back feature is disabled, the **Spkr** softkey will not appear and the **START** key will not work to place a call from any call log. You must exit the **Call Details** screen and place the call as described above.

Clear a call log or clear all call logs

1. Open the **Call Logs** and select **Clear Logs**. Press **NavOK**.
2. Select which log you want to clear or **All Call Logs** to clear all logs. Press **NavOK**.
3. A confirmation screen will prompt you to press a **Yes** or **No** softkey before the deletion is done.

Enable/disable call logging

Open the **Call Logs** and scroll down to reveal and select the **Disable Logs** option. This is a toggle option. The info line indicates if logging is disabled or enabled. Press **NavOK** to disable if enabled or to enable if disabled.

Note that disabling the logs will not survive a power cycle if logs have been enabled at the system level.

Clear missed call icon

The missed call icon appears when a call is missed and automatically clears when the missed call log is opened, when the missed calls are cleared and when all logs are cleared.

The missed call icon also clears when the handset is turned off.

Transfer a Call (blind)

1. While in a call, press **FCN** and then select the **Transfer** option by pressing key **1** or **NavOK**.
 - The current call will be placed on hold and it will be marked with a transfer icon **X**.
 - A new call will be started and you will hear a dial tone.)
2. Dial the number to which you wish to transfer the call, or press the **Favr** softkey and select an entry from the Favorites menu.
3. Press **FCN** and select the **Transfer** option again. The marked call will be transferred to the number that you have entered.
4. Press the **END** key to return to standby mode. If the transfer fails, you will see an error message and you can then pick up the original call by navigating to the marked call and pressing **NavOK**.

Transfer a Call (consulted)

1. While in a call, press **FCN** and then select the **Transfer** option by pressing key **1** or **NavOK**.
 - The current call will be placed on hold and marked with a transfer icon **X**.
 - A new call will be started and you will hear a dial tone.)
2. Dial the number to which you wish to transfer the call, or press the **Favr** softkey and select an entry from the Favorites menu.

3. Press **NavOK** or **START** to establish a second call.
4. Inform the person on the other end that you would like to transfer the call.
5. Press **FCN** and select the **Transfer** option to transfer the call.
6. Press the **END** key to return to standby.

Transfer an Active Call to a Call on Hold

1. Press **FCN** and then select the **Transfer** option by pressing **NavOK**. The active call will be placed on hold and its tab will display a transfer icon **X**.
2. Navigate to the second call (already on hold).
3. Press the **Resm** softkey and tell the other party that the call will be transferred.
4. Press **FCN** and select the **Transfer** option by pressing **NavOK**.
5. Press the **END** key to return to standby.

Listen to Voicemail

When the handset has a voicemail message, the voicemail icon  displays. If the handset has multiple lines, the Line menu indicates which line(s) has new voicemails by displaying a plus (+) symbol between the Line number and the Extension number. The (+) symbol disappears when all new voicemail messages have been read.

1. Press **START**.
2. Press the **Msg** softkey, or dial your voice message system number and press **START** or **Nav OK**.

Activate Installed Custom Applications

1. Press **START** or **Spkr**.
2. Press **FCN**.
3. Navigate to the desired custom application using **Nav ▲▼** keys or the **More** softkey.
4. Select the application using **NavOK** or shortcut key.

Use the Phonebook and Speed Dial

Press the **Phbk** softkey from standby mode. The phonebook may also be opened by pressing the **Save** softkey when it appears in a call log or during predialing.



The phonebook list is sorted alphabetically.

The **<new>** option appears until the maximum number of entries (20) has been entered.

Search for a phonebook entry

Use **Nav▲** and **Nav▼** to scroll through the names or press the keys corresponding to the first letters of the name. Use **Nav◀** and **Nav▶** to edit the search characters as needed.

View a phonebook entry

Select the name and press **NavOK**.

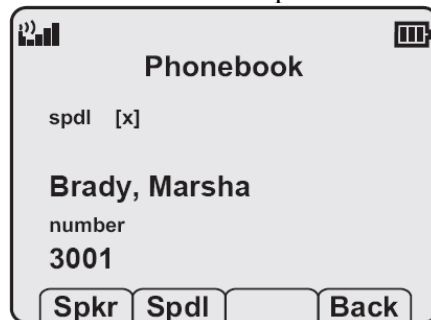

The entry may be called, assigned a speed dial number or edited from this screen. If a speed dial number has been assigned to this name, it will appear beside **spd**.

Return to the phonebook list by pressing the **Back** softkey or **NavOK**.

Edit a phonebook entry

1. Select the name to edit from the phonebook list.
2. Press the **Edit** softkey to open the **Edit Number** display and edit the existing number. Use the **Clr** and **Del** softkeys as needed.
3. Press **NavOK** to display the **Edit Name** display and edit the name.
4. Press **NavOK** to save the changes and exit the editing screens. Press the **Back** softkey to exit without saving the changes.

Dial phonebook number

Select the entry and press **START** or the **Spkr** softkey.



Enter a new name and number in the phonebook

1. Open the phonebook.
2. Select the **<new>** option (if available) and press the **Edit** softkey to open the **Enter Number** display.
3. Enter the name and number by following the steps for editing a name and number. You must enter alphanumeric characters for the name, not blank spaces.

Delete a phonebook entry

1. Open the phonebook and select the entry.
2. Press the **Del** softkey to delete the entry.

Open the speed dial list from standby

Press the **Spdl** softkey from standby mode.

Make a speed dial call

1. From standby or while in the speed dial menu, press and hold the corresponding number key on the keypad for one second. The system speed dial key must be pressed for three seconds.
2. The handset will display the name and number for one second before the call is dialed. You may press **END** during this second to terminate the call. (You may also use the Nav keys to highlight an entry and then press **START** or the **Spkr** softkey to dial the number.)

If you do not place a call, you may return to standby by pressing the Exit softkey.

Assign a speed dial number

A phonebook entry may be assigned to a speed dial key from the speed dial list or from the phonebook edit number display.

From the speed dial list:

1. Select the speed dial key that you wish to assign.

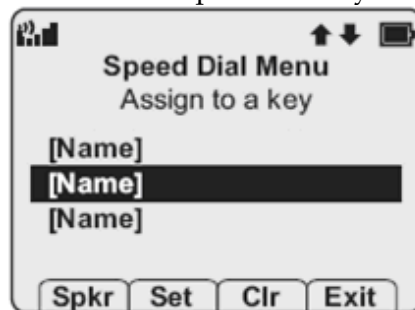

2. Press the **Set** softkey to open the phonebook list.
3. Use the search routine or the **Nav** keys to select the desired entry.



4. Press **NavOK** to assign the selected name to that speed dial key.
5. Press **NavOK** again to exit to standby.

From the phonebook view number display:

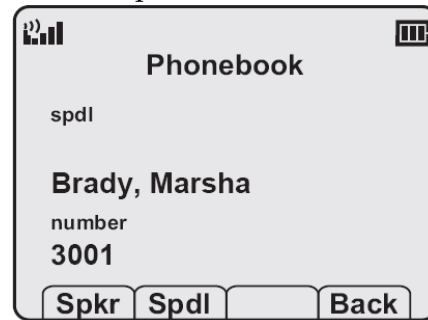

1. Press the **Spdl** softkey from the view number display in the phonebook.
2. When the speed dial list opens, navigate to an empty slot and press **NavOK**. This sets the speed dial key to the number in the phonebook.
3. Press **END** to exit to standby mode and save the speed dial number assignment.

Speed dial entries may be edited through the phonebook, as described above.

Using the Push-to-Talk Features of your SpectraLink 8030 Wireless Telephone

The PTT feature allows SpectraLink 8030 Wireless Telephones to operate in a group broadcast mode called PTT mode. The handsets behave like walkie-talkies, where a single handset can transmit to multiple listeners. If the system administrator has disabled PTT, the PTT options will not appear in the Config menu.

Press and release the **TALK** button to display the default channel, the last channel used, any additional subscribed channels, and the Priority Channel.

Press and hold the **TALK** button to open the default PTT channel for transmission. Release the **TALK** button to end the transmission and await reply. The handset will wait for 10 seconds before reverting to standby mode.



PTT mode requires additional battery resources. Ensure your handset is equipped with an Extended or Ultra-Extended Battery Pack for optimal performance.

This chapter provides basic operating instructions for operating the PTT features of the SpectraLink 8030 Wireless Telephone. This chapter contains instructions on how to:

- Make a PTT call
- Respond to a PTT call
- End a wait period
- Select a different PTT channel
- End one PTT call and start another one
- Receive a PTT call while on a telephone call
- Transmit on the priority channel

- End a PTT call
- Change the PTT volume
- Answer a telephone call during a PTT transmission
- Start a telephone call during a PTT transmission
- Turn off PTT
- Subscribe to additional PTT channels

Make a PTT Call

To call on the default channel, from standby mode press and hold the **TALK** button. Wait for the display to show **Transmitting** and then hold the handset approximately two inches from your mouth and speak.

Respond to a PTT Call

Press and hold the **TALK** button during the 10-second wait period.

End a Wait Period

Press the **END** key.

Select a Different PTT Channel

Press and release the **TALK** button. Use the **Nav** keys or up/down side buttons to highlight the desired channel. Press **TALK** to transmit.

End One PTT Call and Start another on a Different Channel

Press the **END** key to exit the PTT call. Press and release the **TALK** button and select a different channel from the list. Press and hold the **TALK** button to begin transmitting on the different channel.

Receive a PTT Call while on a Telephone Call

Press the **END** key to end the telephone call. Now you can hear the PTT call.

Use PTT Vibrate

To enhance the alerting of a PTT call, **PTT Vibrate** may be enabled on the **Config** menu.

When **PTT Vibrate** is enabled, the handset will vibrate three times whenever a PTT broadcast is received, whether the handset is in standby or in a call. If in a call, the chirp alert will also sound. The vibration does not replace any PTT tone volume already set. To set the handset for PTT vibrate only, enable **PTT Vibrate** and set the tone volume to zero.

PTT Vibrate is disabled by default.

Transmit on the Priority Channel

Press and release the **TALK** button. Select the priority channel from the list. Press and hold **TALK**, then speak. The priority channel takes priority over all other calls in progress.

End a PTT Call

Press the **END** key to exit the PTT call.

Change the PTT Volume

Press the up/down volume buttons on the side of the handset while transmitting or receiving a PTT call.

Answer a Telephone Call during a PTT Transmission

Press the **START** key. PTT transmissions will be pre-empted by the telephone call.

Start a Telephone Call during a PTT Transmission

Press the **START** key and dial the number. PTT transmissions will be pre-empted by the telephone call.

Turn off PTT

Change to a different profile. (The **Silent** and **Vibrate** profiles disable PTT by default.)

Subscribe to additional PTT channels

Press the **Cfg** softkey to open the Config menu and select **Push-to-talk**. Select **Subscribed channels** and then select the channels you want to add. Subscribed channels are marked with an asterisk (*).

Charger Options

Charger Models

Three charger models are available for the SpectraLink 8020/8030 Wireless Telephone. The Single Charger will charge a single handset with an installed Battery Pack. The Dual Charger will charge the handset and a spare Battery Pack. The Quad Charger can charge up to four Battery Packs at a time. Any SpectraLink Battery Pack can be charged in any of these chargers.

The Single and Dual Chargers allow the handset to remain operative in speakerphone mode or with a headset while charging. Handsets may be charged while in standby mode, while in an active call, or while turned off.

Install the Charger

Set up the Charger by first obtaining the appropriate SpectraLink power supply for the country or region. Place the Charger on a flat, horizontal surface. Plug the power supply into the Charger and into an appropriate wall outlet.

Charging Status Indicators

The handset speaker, handset display, and the charger LED (on the Dual and Quad Chargers), indicate charging status or that a Battery Pack failure has been detected.

Handset Message/ LED	Charging Status
-------------------------	-----------------

Ascending song	Occurs when handset has been inserted into the charger and charging has begun.
----------------	--

Charging... LED Solid On	The Battery Pack is charging.
-----------------------------	-------------------------------



Note that in the Dual Charger, the handset's Battery Pack takes charging precedence. When it is finished charging, the single Battery Pack in the rear slot will charge.

Charge Complete	The Battery Pack in the handset has finished charging.
-----------------	--

LED Off	Battery Pack is fully charged, slot is empty, or unit is not powered.
---------	---

Battery Failure LED Flash	Error. Battery Pack not able to be charged. Reinsert Battery Pack or replace Battery Pack.
------------------------------	--

Descending song	Occurs when handset is removed from charger.
-----------------	--

Single Charger



The Single Charger is designed to allow the handset to remain operational through speakerphone or headset use while the handset's Battery Pack is being charged. The handset may also be charged while it is in standby mode or turned off.

Place the handset in the Single Charger facing forward. While the handset is charging in standby mode, it will display its extension number and **Charging....** An animated battery icon will indicate that charging is in progress. The handset is fully operational and will ring if called. When the handset is charging while turned off, only **Charging...** will display and no calls will be received. The dots will be racing during the charging cycle.

When the handset is fully charged, **Charge Complete** will display.

No charging information will display during an active call.

Dual Charger

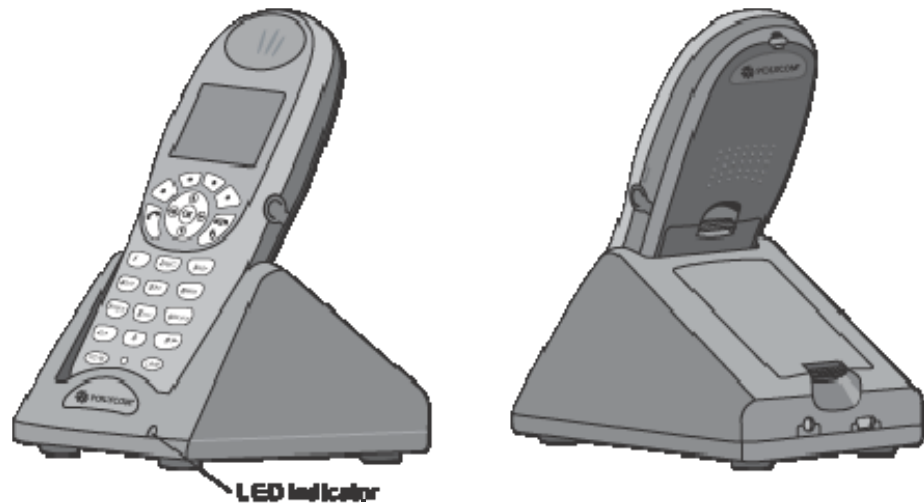

The Dual Charger is designed to charge the Battery Pack in the handset while it remains operational and also charge an additional Battery Pack in the rear charging bay. The handset has charging priority when both slots are occupied.

Place the handset in the front slot, facing forward. The Battery Pack alone snaps into the charging bay as shown in the illustration.

The LED indicates the status of the Battery Pack in the rear bay. The handset displays its charging status as described for the Single Charger.

When the handset is fully charged or is removed, the Battery Pack will begin charging.

Note that the time it takes for the Battery Pack to charge will be lengthened if its charging cycle is interrupted for a handset to charge.

Quad Charger

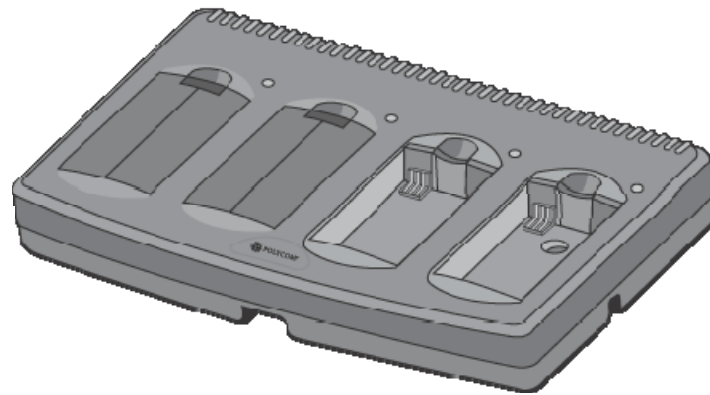

The Quad Charger is designed to simultaneously charge four Battery Packs. It may be mounted on a horizontal or vertical surface.

The Battery Pack snaps into the charging slot. The LED above the occupied bay indicates the charging status of the Battery Pack in the bay.



A flashing LED may indicate a Battery Pack failure. Verify the condition of the Battery Pack by the following procedure before replacing it. First check the Battery Pack in a different bay or substitute another charger and repeat the operation that caused the failure. If the same Battery Pack lights a steady LED when inserted in a different bay or charger, the first charger may be faulty. Contact your system administrator for service information.

Cleaning and Drying the Handset



The SpectraLink 8030 Wireless Telephones have been tested for resistance to cleaning chemicals per IEC 60068-2-74 (1999), Exposure of the 8020/8030 handsets to Lysol® or diluted bleach poses little risk of functional or cosmetic damage.

- Avoid dropping the handset or knocking it against hard surfaces. Carrying the handset in a holster or carrying case will help protect it.
- There are no serviceable parts in the handset or chargers. You should not open the handset case nor disassemble the chargers. Doing so will void your warranty.
- Turn off the handset and unplug chargers before you clean them. Never immerse either in liquid. Clean the exterior surfaces, including the charging contacts, with a cloth that has been slightly moistened with water. Take care not to exert undue pressure on charger electrical contacts while wiping.
- Polycom recommends the use of a silicone cover to prolong the life of your handset, especially when it is dropped regularly or cleaned frequently with the disinfectants prescribed below.
- Wiping the handset surface with a water-dampened cloth or paper towel will remove most films or residues. If the soiling is too stubborn for plain water, a mild detergent solution, Lysol, isopropyl alcohol or diluted bleach may be used.
- Pre-treated cloths and toiettes, like those used for eyeglasses or cameras, may be used to clean the phone, however avoid using those containing lanolin or aloe as it will leave a slippery residue.
- When cleaning with disinfectants, do not rub the keypad characters vigorously. Doing so will degrade legibility of the handset's keys.
- Do not directly spray or immerse the phone in a disinfectant or cleaning agent. Spray the disinfectant on a soft cloth or paper towel, then wipe the phone's surface to dry it.

- The following products should NOT be used on the SpectraLink wireless telephones.
 - Do not use cleaning products containing quaternary ammonium compounds,³ such as CaviWipes™, CaviWipes™ XL, Cavicide® or Sani-Wipes®, Sani-Cloth, Super Sani-Cloth® and Sani-Cloth® Plus. Quaternary ammonium compounds have been laboratory tested and proven to damage the handset plastics.
 - Do not use furniture polishes, waxes or plasticizer based cleaner (ArmorAll®, etc.)
 - Do not use lanolin, aloe, glycerin or other skin care type products
 - Do not apply any solvent such as acetone, mineral spirits etc.
- Should the headset connector become dirty, a scratchy or intermittent signal may be experienced. To clean the connector, dip the non-padded end of either a wooden or paper handled cotton swab in isopropyl alcohol. Gently insert in the connector and twist, repeating several times. If available, blow compressed air into the connector to clear debris.
- Keep the headset jack covered when it is not in-use.
- Using a carrying case may help protect the surfaces and help prevent liquids (e.g., rain) from entering into the interior of the handset. This product is not waterproof, and exposing the unit to liquids may result in permanent damage to the unit.

If your wireless telephone interior gets wet, then do not try to accelerate drying with the use of an oven or a dryer as this will damage the wireless telephone and void the warranty. Instead, do the following:

1. Immediately power off the wireless telephone.
2. Remove Battery Pack from wireless telephone.
3. Shake excess liquid from the wireless telephone.
4. Place the wireless telephone and Battery Pack in an area that is at room temperature and has good airflow.
5. Let the wireless telephone and Battery Pack dry for 72 hours before reconnecting the Battery Pack and/or powering on the wireless telephone.

³ Quaternary ammonium compounds are also known as C12-18-alkyl [(ethylphenyl) methyl] dimethyl, chlorides and Benzyl-C12-18-alkyldimethyl ammonium chlorides. Review the Materials Safety Data Sheet for your specific product to verify the chemical composition.

If the wireless telephone does not work after following the steps listed above, contact your dealer for servicing information.

Safety Information

Chargers and Battery Packs

It is normal for the Battery Pack to become warm when charging.

Chargers operate in a 50° to 85° F (10° to 30° C) environment. Do not expose them to freezing temperatures or direct sunlight.

Do not place anything in the charger other than the handset or single Battery Pack as appropriate, to avoid bending the contacts. Bent contacts can keep the Battery Pack from charging.

Only use SpectraLink Battery Packs with SpectraLink chargers.

Never use a non-SpectraLink charging unit as it could damage the Battery Pack.

Only use the original plug-in power adapter for the chargers.

Contact your service representative for assistance if you have a faulty Battery Pack or a problem with your charger.

Any battery which exhibits swelling, cracking or other abnormality should be disposed of promptly and properly.



Do not immerse the Battery Pack in water or throw into fire.



Do not throw away the Battery Pack with your domestic waste. Take used Battery Packs to an appropriate collection point for recycling or send them back to your supplier or servicing agent.



All batteries can cause property damage and/or bodily injury, such as burns, if a conductive material such as jewelry, keys, or beaded chains touches exposed terminals. The conductive material may complete an electrical circuit (short circuit) and become quite hot. Exercise care in handling any charged

battery, particularly when placing it inside a pocket, purse, or other container with metal objects.

Wireless Telephones



WARNING: Changes or modifications to this equipment that are not approved by Polycom may cause this equipment to fail to comply with part 15 of the FCC rules, voiding the user's authority to operate this equipment.



WARNING: Polycom products contain no user-serviceable parts inside. Refer servicing to qualified service personnel.



It is recommended that standard acceptance procedures be followed prior to operating this equipment in proximity of life-support systems.



Earpiece may retain magnetic objects.

Operational Warnings

Potentially explosive atmospheres

Turn off your handset prior to entering any area with a potentially explosive atmosphere. Do not remove, install, or charge batteries in such areas. Sparks in a potentially explosive atmosphere can cause an explosion or fire resulting in bodily injury or even death.



Areas with potentially explosive atmospheres include fueling areas such as below decks on boats, fuel or chemical transfer or storage facilities, areas where the air contains chemicals or particles such as grain, dust, or metal powders, and any other area where you would normally be advised to turn off your vehicle engine. Areas with potentially explosive atmospheres are often posted, but not always.

Electromagnetic Interference and Compatibility

Nearly every electronic device is susceptible to electromagnetic interference (EMI) if inadequately shielded, designed, or otherwise configured for electromagnetic compatibility.

Facilities

To avoid electromagnetic interference and/or compatibility conflicts, turn off your handset in any facility where posted notices instruct you to do so. Hospitals or health care facilities may be using equipment that is sensitive to external RF energy.

Pacemakers

The Health Industry Manufacturers Association recommends that a minimum separation of 6 inches (15 cm) be maintained between a handheld, wireless-radio product and a pacemaker. These recommendations are consistent with the independent research by, and recommendations of, Wireless Technology Research. Persons with pacemakers should:

- ALWAYS keep the handset more than 6 inches (15 cm) from their pacemaker when the handset is turned on.
- Not carry the handset in a breast pocket.
- Use the ear opposite the pacemaker to minimize the potential for interference.
- Turn the handset off immediately if you have any reason to suspect that interference is taking place.

Hearing aids

Some digital wireless handsets may interfere with some hearing aids. The Phone Settings option – **Use Hearing Aid** – is designed to improve the audio for hearing aid users. If interference persists, you may want to consult your hearing-aid manufacturer to discuss alternatives.

Other medical devices

If you use any other personal medical device, consult the manufacturer of your device to determine if it is adequately shielded from external RF energy. Your physician may be able to assist you in obtaining this information.

Use While Driving

Campus installations and warehouse facilities that use vehicles such as forklifts or golf carts should abide by these guidelines when using wireless telephones:

- Give full attention to driving and to the road, aisle, or path.
- Use hands-free operation, if available.
- Pull off the road, aisle, or path and park before making or answering a call.

For vehicles equipped with an airbag

Do not place a portable device in the area over the airbag or in the airbag deployment area. An airbag inflates with great force. If a handset is placed in the airbag deployment area and the airbag inflates, the handset may be propelled at high speed and cause serious injury to occupants of the vehicle.

FCC Statement

This device complies with part 15 of the FCC Rules. Operation is subject to the following two conditions: (1) This device may not cause harmful interference, and (2) this device must accept any interference received, including interference that may cause undesired operation.

Specific Absorption Rate (SAR) Information

Your wireless telephone is a low power radio transmitter and receiver. When it is ON, it receives and also sends out radio frequency (RF) signals. In August 1996, the Federal Communications Commissions (FCC) adopted RF exposure guidelines with safety levels for hand-held wireless phones. Those guidelines are consistent with the safety standards previously set by both U.S. and international standards bodies:

- ANSI C95.1 (1992) American National Standards Institute
- NCRP - Report 86 (1986) National Council on Radiation Protection and Measurements
- ICNIRP (1996) International Commission on Non-Ionizing Radiation Protection;
- DHWC - Safety Code 6 Department of Health and Welfare Canada

Those standards were developed by independent scientific organizations through periodic and thorough evaluation of scientific studies. The standards include a substantial safety margin designed to assure the safety of all persons, regardless of age and health. The exposure standard for wireless mobile phones employs a unit of measurement known as the Specific Absorption Rate, or SAR. The SAR limit set by the FCC is 1.6W/kg.



In the United States and Canada, the SAR limit for mobile phones used by the public is 1.6 watts/kg (W/kg) averaged over one gram of tissue. The standard incorporates a substantial margin of safety to give additional protection for the public and to account for any variations in measurements.

Tests for SAR are conducted using standard operating positions specified by the FCC with the phone transmitting at its highest certified power level in all tested frequency bands. Although the SAR is determined at the highest certified power level, the actual SAR level of the phone while operating can be well below the maximum value. This is because the phone is designed to operate at multiple power levels so as to use only the power required to reach the network. In general, the closer you are to a wireless Base Station antenna, the lower the power output. Before a phone model is available for sale to the public, it must be tested and certified to the FCC that it does not exceed the limit established by the government-adopted requirement for safe exposure. The tests are performed in positions and locations

(e.g., at the ear and worn on the body) as required by the FCC for each model. While there may be differences between the SAR levels of various phones and at various positions, they all meet the government requirement for safe exposure.

The FCC has granted an Equipment Authorization for this model phone with all reported SAR levels evaluated as in compliance with the FCC RF emission guidelines.

SAR information on this model phone is on file with the FCC and can be found under the Display Grant section of <http://www.fcc.gov/oet/ea> after searching on FCC ID IYG702X or FCC ID IYG703X. Additional information on Specific Absorption Rates (SAR) can be found on the Cellular Telecommunications Industry Association (CTIA) web-site at <http://www.ctia.org>.

The only authorized headsets that may be utilized with the SpectraLink 8020 or 8030 handsets are those obtainable from Polycom or its reseller partners.

FCC SAR peak values (in W/kg):

Frequency	802X-head	802X-body	803X-head	803X-body
2.4 GHz	0.23	0.16	0.22	0.19
5.2 GHz	0.36	0.37	0.39	0.40
5.4 GHz	0.35	0.39	0.40	0.37
5.8 GHz	0.37	0.20	0.28	0.27

EU SAR peak values (in W/kg):

Standard	Frequency	802X head	802X body	803X head	803X body
802.11 b		0.119	0.093	0.114	0.104
802.11 g		0.059	0.048	0.046	0.039
802.11 a	(5150-5250 MHz)	0.090	0.147	0.091	0.164
802.11 a	(5250-5350 MHz)	0.043	0.113	0.051	0.095
802.11 a	(5470-5725 MHz)	0.356	0.156	0.088	0.153

Handset operation normal position

Hold the handset as you would any other telephone, with the earpiece to your ear and speak into the microphone. The internal antenna is then positioned properly.

Index

B

Battery Packs	10
Low battery	10
Safety	67

C

Chargers	
Charging status	58
Dual	60
Quad	61
Safety	67
Setup	57
Single	59
Cleaning and drying the handset	63
Config menu	23
Default settings	26

D

Display screen	14
----------------------	----

F

Favorites menu	18
Features	12
Advanced	43
Basic	33
Firmware version	32
Function (FCN) menu	19

I

Icons	15
Call status	15
System	15
IP address, displaying	32

L

Line menu	18
-----------------	----

M

Menus

Config	23
Favorites	18
Function (FCN)	19
Line	18
Symbol	18

Modes

Active	20
Configuration	21
Messaging	21
Push-to-talk	20
Standby	20

P

Phone Settings, Config menu	30
Phonebook	49
Push-to-talk (PTT) features	53
Push-to-talk, Config menu settings	31

S

Safety

Electromagnetic interference	69
Explosive atmospheres	68
Specific Absorption Rates	71
Use while driving	70

Safety warnings	68
-----------------------	----

SAR	71
-----------	----

Softkeys

Functions	16
NavOK	17

Software version	32
------------------------	----

Specific Absorption Rates	71
---------------------------------	----

Speed dial	49
------------------	----

Symbol menu	18
-------------------	----

System info, config menu option	32
---------------------------------------	----

U

User profiles	27
---------------------	----

Free Manuals Download Website

<http://myh66.com>

<http://usermanuals.us>

<http://www.somanuals.com>

<http://www.4manuals.cc>

<http://www.manual-lib.com>

<http://www.404manual.com>

<http://www.luxmanual.com>

<http://aubethermostatmanual.com>

Golf course search by state

<http://golfingnear.com>

Email search by domain

<http://emailbydomain.com>

Auto manuals search

<http://auto.somanuals.com>

TV manuals search

<http://tv.somanuals.com>