



# ▶ MGC+50/MGC+100 Getting Started Guide

**Version 9.0.4 | August 2010 | DOC2231A**

**Trademark Information**

Polycom®, the Polycom “Triangles” logo, and the names and marks associated with Polycom’s products are trademarks and/or service marks of Polycom, Inc., and are registered and/or common-law marks in the United States and various other countries.

All other trademarks are the property of their respective owners.

**Patent Information**

The accompanying product is protected by one or more U.S. and foreign patents and/or pending patent applications held by Polycom, Inc.

© 2010 Polycom, Inc. All rights reserved.

Polycom, Inc.  
4750 Willow Road  
Pleasanton, CA 94588-2708  
USA

No part of this document may be reproduced or transmitted in any form or by any means, electronic or mechanical, for any purpose, without the express written permission of Polycom, Inc. Under the law, reproducing includes translating into another language or format.

As between the parties, Polycom, Inc., retains title to and ownership of all proprietary rights with respect to the software contained within its products. The software is protected by United States copyright laws and international treaty provision. Therefore, you must treat the software like any other copyrighted material (e.g., a book or sound recording).

Every effort has been made to ensure that the information in this manual is accurate. Polycom, Inc., is not responsible for printing or clerical errors. Information in this document is subject to change without notice.

## Regulatory Notices

### United States Federal Communication Commission (FCC)

**Part 15: Class A Statement.** This equipment has been tested and found to comply with the limits for a Class A digital device, pursuant to Part 15 of the FCC Rules. Test limits are designed to provide reasonable protection against harmful interference when the equipment is operated in a commercial environment. This equipment generates, uses, and can radiate radio-frequency energy and, if not installed and used in accordance with the instruction manuals, may cause harmful interference to radio communications. Operation of this equipment in a residential area is likely to cause harmful interference, in which case the user will be required to correct the interference at his or her own expense.

**Part 68: Network Registration Number.** This equipment is registered with the FCC in accordance with Part 68 of the FCC Rules. This equipment is identified by the FCC registration number.

If requested, the FCC registration Number and REN must be provided to the telephone company.

Any repairs to this equipment must be carried out by Polycom Inc. or our designated agent. This stipulation is required by the FCC and applies during and after the warranty period.

#### United States Safety Construction Details:

- Unit is intended for RESTRICTED ACCESS LOCATION.
- Unit is to be installed in accordance with the National Electrical Code.
- The branch circuit overcurrent protection shall be rated 20 A for the AC system.
- This equipment has a maximum operating ambient of 40°C, the ambient temperature in the rack shall not exceed this temperature.
- To eliminate the risk of battery explosion, the battery should not be replaced by an incorrect type.  
Dispose of used batteries according to their instructions.

### CE Mark R&TTE Directive

Polycom Inc., declares that the MGC+50 and MGC+100 with NET-8 card is in conformity with the following relevant harmonized standards:

EN 60950: 1992 Including Amendments 1,2,3 & 4

EN 55022: 1994

EN 50082: 1997

Following the provisions of the Council Directive 1999/CE on radio and telecommunication terminal equipment and the recognition of its conformity.

#### Canadian Department of Communications

This Class [A] digital apparatus complies with Canadian ICES-003.

**Notice:** The Industry Canada label identifies certified equipment. This certification means that the equipment meets telecommunication network protective, operational and safety requirements as prescribed in the appropriate Terminal Equipment Technical Requirements document(s). The Department does not guarantee the equipment will operate to the user's satisfaction.

Before installing this equipment, users should ensure that it is permissible to be connected to the facilities of the local telecommunications company. The equipment must also be installed using an acceptable method of connection. The customer should be aware that compliance with the above conditions may not prevent degradation of service in some situations. Repairs to certified equipment malfunctions, may give the telecommunications company cause to request the user to disconnect the equipment.

Users should ensure for their own protection that the electrical ground connections of the power utility, telephone lines and internal metallic water pipe system, if present, are connected together. This precaution may be particularly important in rural areas.

**Caution:** Users should not attempt to make such connections themselves but should contact the appropriate electric inspection authority or electrician, as appropriate.

## Regulatory Notices

### Singapore Certificate

MGC+100 --- Complies with IDA standards G1260-05  
MGC+50 --- Complies with IDA standards G1261-05

### Russian Communication Certificate

The MGC+100 and MGC+50 comply with the Russian Ministry of Communication requirements stated in certificate OC/1-MM-15.



### Taiwan Certificate

#### 警告使用者:

這是甲類的資訊產品, 在居住的環境中使用時, 可能會造成射頻干擾, 在這種情況下, 使用者會被要求採取某些適當的對策.

# Table of Contents

<b>Before You Begin</b> .....	<b>1-1</b>
System Overview .....	1-1
Network Equipment, Numbers and Addresses .....	1-2
Overview of the Getting Started Guide .....	1-3
<b>Hardware Installation</b> .....	<b>2-1</b>
MGC+100 Hardware Installation .....	2-2
Inspecting the MGC+/ReadiManager IAM Package Contents ..	2-2
System Safety .....	2-2
General Safety Precautions .....	2-2
Rack Mount Safety Precautions .....	2-3
Polycom MGC+/ReadiManager Precautions .....	2-3
Unpacking and Positioning the MGC+100 .....	2-4
Mounting the MGC+100 in a 23" Rack .....	2-6
MGC+50 Hardware Installation .....	2-7
Unpacking and Positioning the MGC+50 .....	2-7
Mounting the MGC+50 on a Rack .....	2-9
Connecting and Setting Up the MGC+100/MGC+50 .....	2-10
Connecting to the Power Source .....	2-10
Connecting the MGC+100/MGC+50 to the Local Network ...	2-11
Connecting the MGC+ to the Conferencing Network .....	2-11
Connecting the MGC+ to the ISDN/ T1-CAS Network ...	2-11
Connecting the MGC+ to the IP Network .....	2-13
First Entry MGC+ Control Unit (CU) IP Configuration .....	2-14
Using the Compact Flash Disk with the LAN.CFG File .....	2-14
Using a Cross-over Hub Cable and a Laptop to Connect to the MCU Locally .....	2-16
Using a Keyboard and Monitor Attached to the MGC+ unit ..	2-19
<b>MGC+ Software Installation and Configuration</b> .....	<b>3-1</b>
Initial ReadManager IAM Configuration .....	3-1
Installing the MGC Manager .....	3-2
Starting the MGC Manager Application .....	3-4

---

Defining the MCU .....	3-5
Connecting to an MCU .....	3-7
Configuring the Network Services .....	3-8
Defining the Network Services .....	3-8
<b>About Conferences .....</b>	<b>4-1</b>
On-Demand (Reservation-less) Conferencing .....	4-1
Ad Hoc Conferencing .....	4-1
Meeting Rooms .....	4-2
Scheduled Conferences .....	4-2
Video Conference Attributes .....	4-3
Entry Queue .....	4-4
<b>Basic Operations .....</b>	<b>5-1</b>
Reservation Templates .....	5-1
Default Reservation Templates .....	5-1
Starting a Conference .....	5-2
Viewing the Conference Dial-in Properties .....	5-4
Connecting to a Conference/Entry Queue .....	5-5
Dialing-in to a Conference/Entry Queue .....	5-5
Monitoring On Going Conferences .....	5-7
General Monitoring .....	5-7
Monitoring a Conference .....	5-8
Listing Participants in the Browser and Status Panes .....	5-10
Participant Level Monitoring .....	5-12
Operations Performed During On Going Conferences .....	5-13
Adding a Participant to a Conference .....	5-13
Defining Dial-out Participants .....	5-13
Making Dial-Out Connections .....	5-18
Disconnecting Participants .....	5-19
Muting a Participant .....	5-20
Locking and Unlocking a Conference .....	5-21
Changing the Conference Duration .....	5-22
Terminating a Conference Manually .....	5-24
Changing the Layout in a Continuous Presence Conference .....	5-25

---

<b>Defining a New Audio Conference</b> .....	<b>6-1</b>
Defining a New Audio Only Entry Queue .....	6-1
Defining an On Going Audio Conference .....	6-5
Defining a New Audio Only Meeting Room .....	6-9
<b>Defining a New Video Conference</b> .....	<b>7-1</b>
Defining a New Video Entry Queue .....	7-1
Setting an Entry Queue as Default .....	7-4
Creating a Target Conference from an Entry Queue .....	7-5
Creating an On Going Video Conference .....	7-6
Defining a New Video Meeting Room .....	7-12
<b>Management Tools</b> .....	<b>8-1</b>
Resource Report .....	8-1
Resources Report - Network Resources .....	8-3
Resource Report - Network Resources Details .....	8-4
Resources Report - Media Resources .....	8-5
Media Resources Area Parameters Description .....	8-5
Port-Unit Allocation Area .....	8-6
Listing the Installed Cards .....	8-8
MCU Faults Report .....	8-11
Reset MCU .....	8-14
Obtaining Additional Information .....	8-14





---

## Before You Begin

This Getting Started Guide provides information on the installation and basic operation of your MGC+50/100. For more information on defining and running conferences, defining IVR services and managing the system, refer to the *MGC Manager User's Guide Volumes I & II* and the *MGC Administrator's Guide*. References to the relevant chapters of these guides are included throughout this Getting Started Guide

The term REDIConvene, used in this documentation, refers to the combined MGC+ unit with the installed Polycom® REDIManager™ Integrated Application Module (IAM). It provides functionality of both the MGC+ unit and the REDIManager™.

## System Overview

The MGC+50 and MGC+100 are high performance, high capacity multi-network solutions that provides you with feature-rich, and easy-to-use multipoint voice, video and gateway conferencing.

The system meets International Telecommunication Union - Telecommunication Standardization Sector, (ITU-T, formerly CCITT) standards for multipoint multimedia bridging devices, and meets ETSI standards for telecommunication products.

The flexible architecture in the system is designed to accommodate users' changing multipoint needs. This system utilizes a modular "universal slot" platform that allows the formation of different configurations based on users' individual port capacity and functionality requirements.

## Network Equipment, Numbers and Addresses

Obtain the following information from your network administrator:

- IP address for the MGC+50/MGC+100
- Subnet Mask for the MGC+50/MGC+100
- Default Gateway IP address (optional)
- Gatekeeper IP address, if applicable
- DNS IP address, if applicable
- SIP server IP address, if applicable

For ISDN configurations, obtain the following equipment and information from your network service provider:

- PRI line(s) or Leased Line(s)
- Directory number range(s)
- Switch Type
- Line Coding
- Line Framing
- Numbering Plan
- Numbering Type



If the MGC+50/100 has to be connected to the public ISDN network, an external CSU or similar equipment is needed.

# Overview of the Getting Started Guide

The MGC+50/MGC+100 Getting Started Guide includes the following topics:

## **Chapter 1 - Before You Begin**

This chapter includes the following:

- System Overview
- System Specifications
- General Site Requirements - Network Equipment, Numbers and Addresses

## **Chapter 2 - MGC+ Unit Hardware Installation**

This chapter includes instructions on how to:

- Unpacking and install the MGC+ unit
- Configure the initial IP of the system

## **Chapter 3 - Software Installation and Configuration**

This chapter includes instructions on how to:

- Install the MGC Manager
- Configure the MGC Manager to work with your MGC+50/MGC+100
- Configure the network services for ISDN and IP connections

## **Chapter 4 - Conference Types**

This chapter describes the major types of conferences that can be scheduled on the MCU, such as Reservationless (Ad Hoc) conferences, Meeting Rooms, video conferences, Audio Only conferences and Entry Queues.

## **Chapter 5 - Basic Operation**

This chapter includes instructions on how to:

- Start a conference from the default conference templates
- Monitor On Going Conferences
- Perform basic operations during an On Going Conference

### **Chapter 6 - Defining a New Audio Conference**

This chapter includes instructions on how to:

- Define the basic parameters of a new Audio Only Entry Queue
- Define a new Standard Audio Only conference
- Define an Audio Only Meeting Room

### **Chapter 7 - Defining a New Video Conference**

This chapter includes instructions on how to:

- Define the basic parameters of a new Video Entry Queue
- Define the basic parameters of a new Video Conference
- Define a Meeting Room

### **Chapter 8 - Management Tools**

This chapter describes the basic management tools for the MGC+50/  
MGC+100:

- Resource Report
- Cards Management
- MCU Faults report
- Reset MCU.



This is an example of the notes that you may encounter throughout this guide.

---

# Hardware Installation

This chapter describes the unpacking and connection of both the MGC+50 and the MGC+100, to the ISDN, T1-CAS, IP, MPI (serial) network(s) and to the operator workstation (PC).

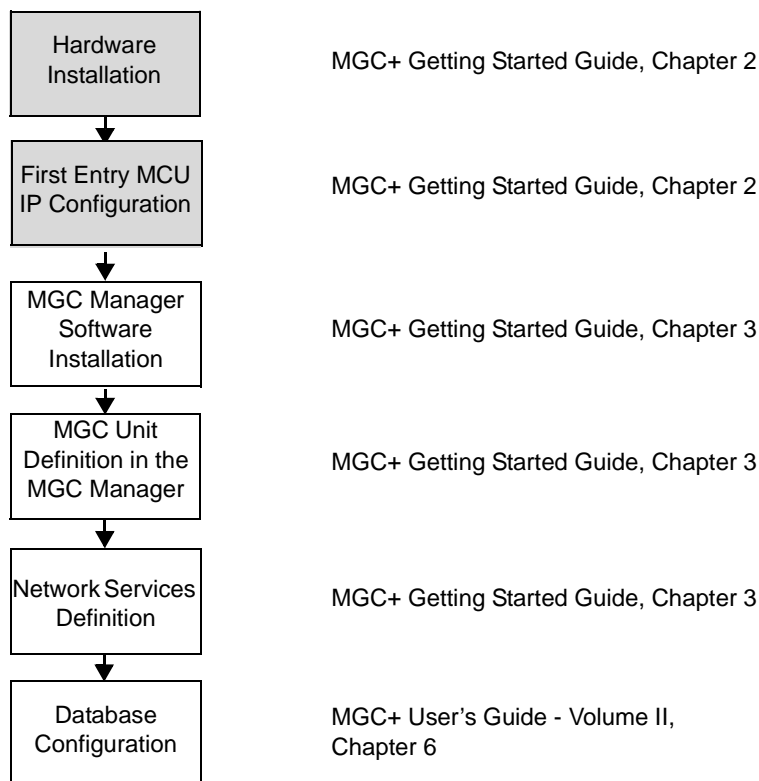

*Figure 2-1: Installation and Configuration Workflow - Hardware Installation*

# MGC+100 Hardware Installation

## Inspecting the MGC+/ReadiManager IAM Package Contents

You should inspect the shipped box and note if it was damaged in any way. If the box items show damage, you should file a damage claim with the carrier who delivered it.

When deciding on a setup location for the MGC+, refer to the section “System Safety” on page 2-2.

### **Disclaimer**

Polycom is not responsible for damage sustained during shipment of this product.

## System Safety

This section includes the follow topics related to system safety:

- “General Safety Precautions” on page 2-2
- “Rack Mount Safety Precautions” on page 2-3
- “Polycom MGC+/ReadiManager Precautions” on page 2-3

## General Safety Precautions

Follow these rules to ensure general safety:

- Keep the area around the Polycom Readiconvene clean and free of clutter.
- The MGC+50 weighs approximately 24 kg (53 lbs) and the MGC+100 weighs approximately 48 kg (106 lbs). When lifting the system, two people at either end should lift slowly with their feet spread out to distribute the weight. Always keep your back straight and lift with your legs.

## Rack Mount Safety Precautions

The following precautions should be followed with regards to rack mount safety:

- Decide on a suitable location for the equipment rack that will hold the MGC+ unit. It should be situated in a clean, dust-free area that is well ventilated. Avoid areas where heat, electrical noise and electromagnetic fields are generated. You will also need it placed near a grounded power outlet.
- Ensure that the leveling jacks on the bottom of the rack are fully extended to the floor with the full weight of the rack resting on them.
- In a single rack installation, stabilizers should be attached to the rack.
- In multiple rack installations, the racks should be coupled together.
- Always make sure the rack is stable before extending a component from the rack.
- You should extend only one component at a time - extending two or more simultaneously may cause the rack to become unstable.
- Before you install the rails, determine the placement of each component in the rack.
- Install the heaviest server components on the bottom of the rack first, and then work up.
- Allow the power supply units to cool before touching them.
- Always keep the rack's front door and all the blade's panels and components closed when not servicing, to maintain proper cooling.

## Polycom MGC+/ReadiManager Precautions

The following precautions should be followed with regards to installation of the ReadiConvene:

Use a regulating uninterruptable power supply (UPS) to protect the MGC+ from power surges and voltage spikes, to keep your MCU and ReadiManager IAM operating in case of a power failure.

## Unpacking and Positioning the MGC+100

To unpack and position the MGC+100:

1. When you receive your MGC+100, inspect the equipment for damage and verify that the components match the packing slip. If you did not receive a component or if there is damage to the system, notify your service representative immediately.

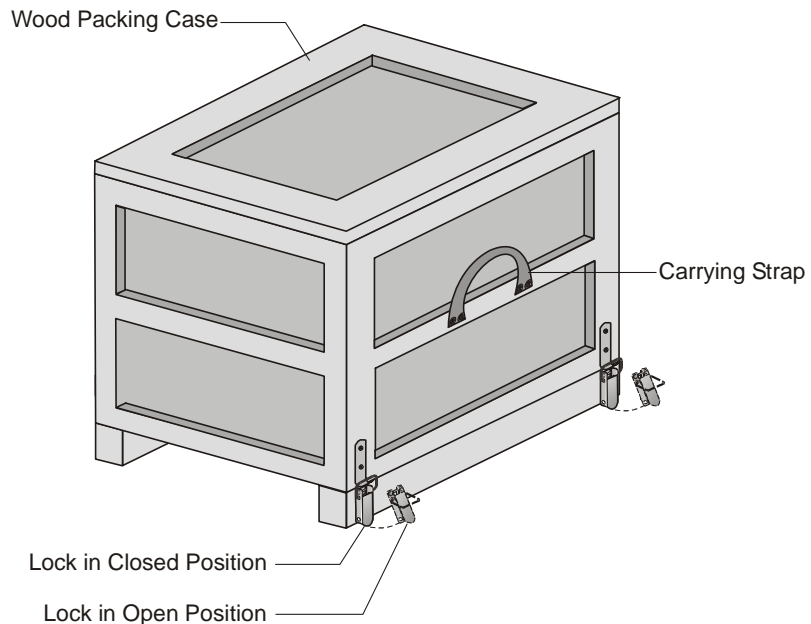

*Figure 2-1: MGC+100 package*

2. Place the MGC+100 unit on a stable flat surface in a location that meets the MGC+ environment requirements, which are:
  - Operating temperature: 10°–40°C (50°–104°F) or 10°–35°C (50°–95°F) when installed in a 19" rack
  - Humidity: 15%–90% non-condensing
  - Altitude: Up to 3,000m (10,000ft)
  - ESD: +8 kV



3. Release the clasp locks at the bottom, and lift the MGC+100 top cover.

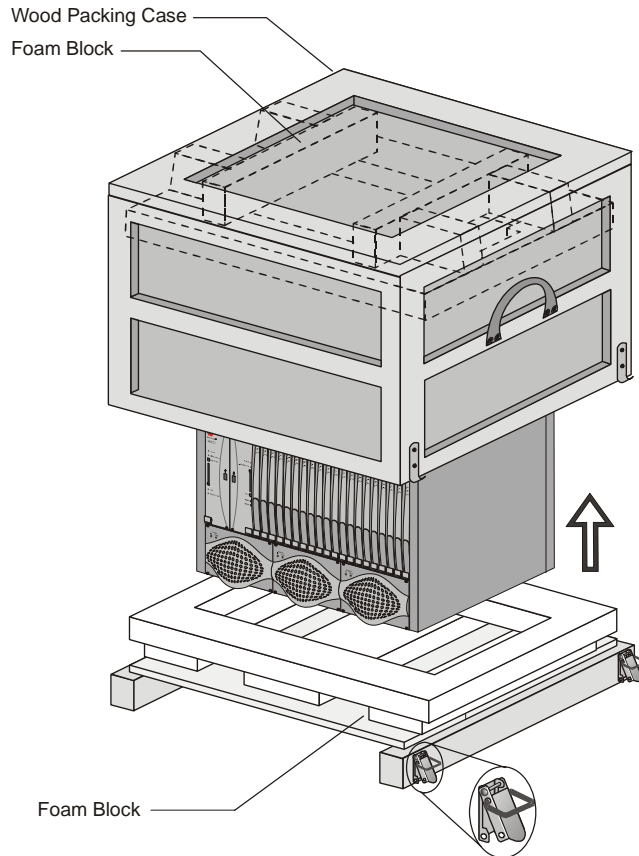

Figure 2-2: Unpacking the MGC+100

4. Lift the MGC+100 unit and remove the packaging material.
5. Lower the MGC+100 unit, placing it on the surface.  
If the MGC+100 is a standalone unit, place it on a flat surface. If you are rack mounting the MGC+100, allow a minimum clearance of 3" above the unit.

## Mounting the MGC+100 in a 23" Rack

The MGC+100 can be mounted in a 23" rack using the two mounting plates that are pre-installed on the unit.

1. Make sure that the MCU is turned OFF and it is disconnected from the AC power.
2. Place the MCU in a 23" rack and support it, screw the mounting brackets to the rack securing it with bolts and self-locking nuts (which the client provides).



When the unit is installed on a rack, the rack must be properly grounded to the central office ground. The rack must be grounded with two-hole compression-type connectors using copper conductors (tinned or untinned). Wire, bus bar or braided strap connectors are acceptable.

If the MGC+100 was shipped without the two mounting plates that are usually pre-installed, refer to the MGC+ Hardware and Installation Manual, Chapter 2 for a detailed description of the installation process.

For a detailed description of mounting the MGC+100 in a 19" rack, see the MGC+ Hardware and Installation Manual, Chapter 2.

# MGC+50 Hardware Installation

## Unpacking and Positioning the MGC+50

### To unpack and position the MGC+50:

1. When you receive your MGC+50, inspect the equipment for damage and verify that the components match the packing slip. If you did not receive a component or if there is damage to the system, notify Polycom immediately.

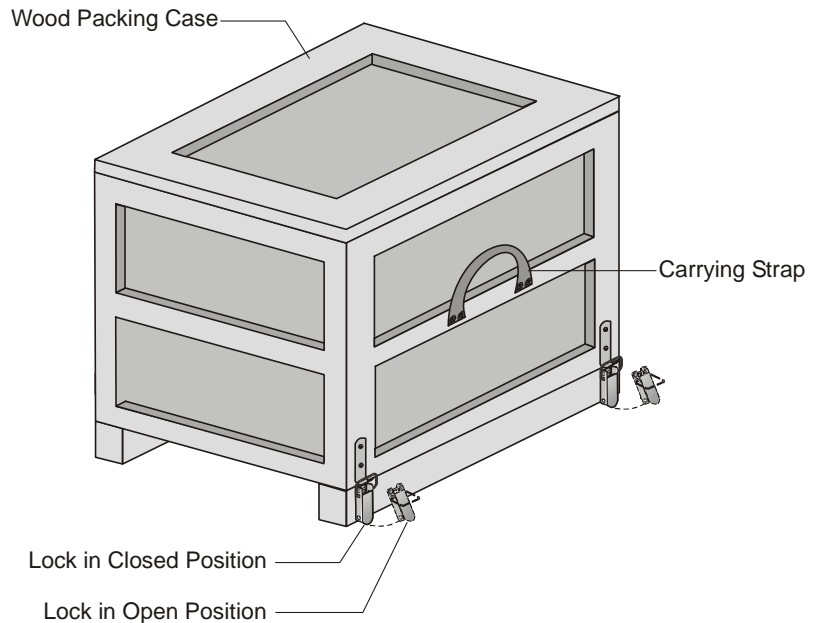
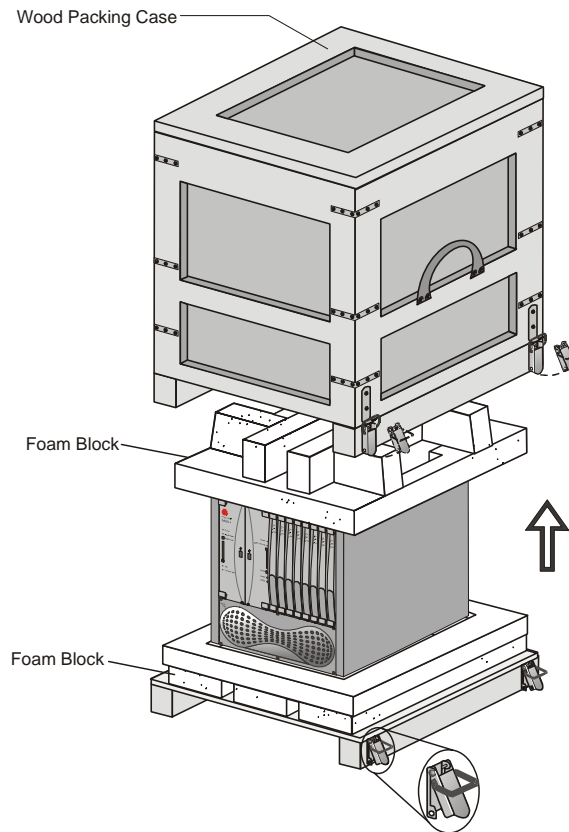

Figure 2-3: MGC+50 package

2. Place the MGC+50 unit on a stable flat surface in a location that meets the MGC+50's environment requirements, which are:
  - Operating temperature: 10°–40°C (50°–104°F)
  - Humidity: 15%–90% noncondensing
  - Altitude: Up to 3,000m (10,000ft)
  - ESD: +8 kV

3. Release the clasp locks at the bottom, and lift the MGC+50 top cover.



*Figure 2-4: Unpacking the MGC+50*

4. Lift the MGC+50 unit and remove the package base.
5. Lower the MGC+50 unit, placing it on the surface.  
If you are rack mounting the MGC+50, allow a minimum clearance of 3 inches above the unit.

## Mounting the MGC+50 on a Rack

The MGC+50 can be mounted in a 19" rack using the two mounting plates that are usually pre-installed.

### To install and mount the MGC+50:

- Place the MGC+50 in a 19" rack and while supporting it, screw the mounting brackets to the rack securing it with nuts.

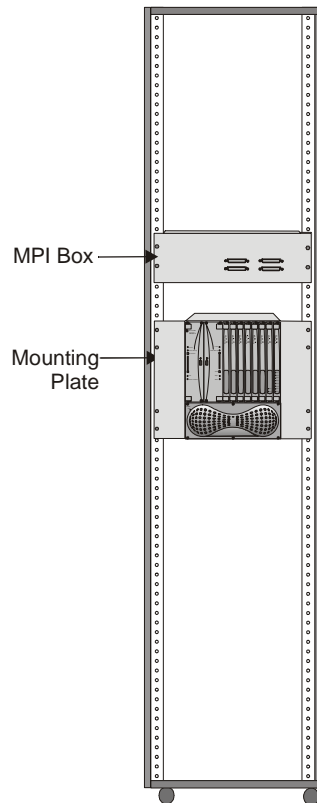

## Connecting and Setting Up the MGC+100/ MGC+50

To Connect the MGC+100/ MGC+50 to the network and power source and set up the system the following procedures are performed:

- Connecting the MGC+ unit to the power source (AC inlet)
- Connecting the MGC+ unit to the LAN Network
- Connecting the MGC+ unit to the network(s)

### Connecting to the Power Source

You can connect to an AC Inlet power supply at your site. It is important to follow these steps.

The following restrictions apply to the conductors and connectors that may be used to ground the unit when rack mounted:

- When using bare conductors, they must be coated with an appropriate antioxidant compound before crimp connections are made. Tinned, solder-plated or silver-plated connectors do not have to be prepared in this manner.
- The same bolt assemblies should not secure multiple connectors.
- Listed fastening hardware must be compatible with the materials being joined and must be preclude loosening, deterioration and electrochemical corrosion of the hardware and joint materials.

#### To connect to the AC Inlet:

1. Make sure the power switch is OFF. Insert the power cable into the power connector on the rear panel of the MGC+100 unit.

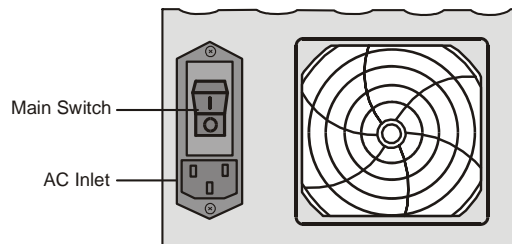

2. Insert the power cable into the power source socket.

3. Turn on the power by pressing on the power switch located on the rear panel of the MGC+100/ MGC+50 unit.

## Connecting the MGC+100/MGC+50 to the Local Network

The MGC+ must be connected to the local LAN network to enable communication between the MGC+ unit and the PC workstations running the MGC Manager application.

Connect one end of a network cable to the LAN connector on the rear I/O panel of the MGC+ Control Module and the other end to the network.

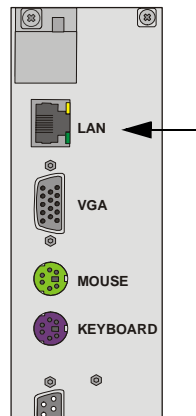

## Connecting the MGC+ to the Conferencing Network



The installation of the MPI box on the MGC+ unit and the connection to the MPI Network module are described in the MGC+ Hardware and Installation Manual, Chapter 2.

### Connecting the MGC+ to the ISDN/ T1-CAS Network



The ISDN network is optional. If the MGC+ has to be connected to the public ISDN network then an external CSU or similar equipment is needed. T1-CAS network is optional. It allows you to connect Audio Only participants to conferences via T1-CAS lines. It uses the same network connections as ISDN and the procedure described below is applicable to both ISDN and T1-CAS lines.

**To connect the MGC+ to the ISDN network or T1-CAS Network:**

- Connect the 8-pin RJ-45 connector of the network cable to the NET RJ-45 jack on the rear panel of the MGC+. Repeat this step for each of the ISDN network lines to be connected to the Network Interface card installed in the MCU.

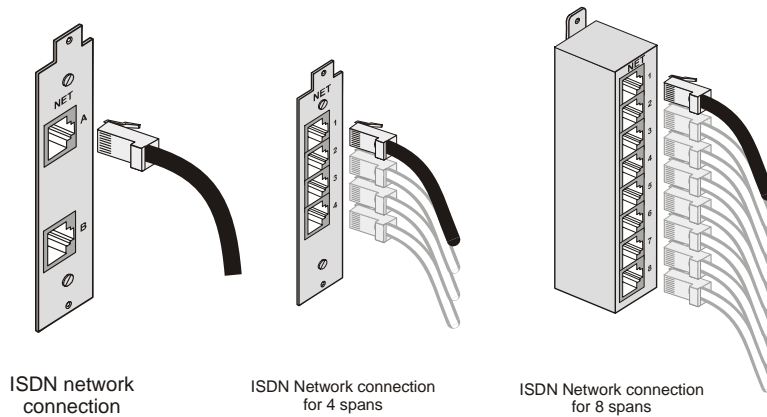

*Figure 2-5: ISDN network connection*

Leased lines should be connected using an adapter with a screw connector with solid conductor wires or a similar adapter.

- Connect one side of the adapter to the NET RJ-45 jack on the rear panel of the MGC+. Then connect the leased line wires to the other side of the adapter.



The ISDN and T1-CAS network properties must be defined in the Network Services. For details, see the MGC+ Administrator's Guide, Chapter 3.



### Connecting the MGC+ to the IP Network

If an IP network Interface card is installed in the MGC+, connect the 8-pin RJ-45 connector of the LAN network cable to the LAN-323 RJ-45 jack on the rear panel of the MGC+.

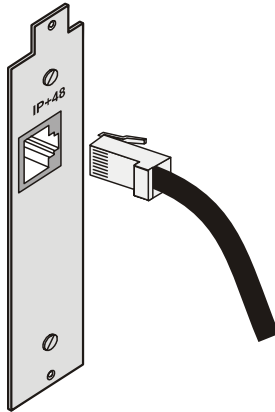

Figure 2-6: LAN IP network connection



The IP network properties must be defined in the Network Services, For details, see MGC+ Administrator's Guide, Chapter 3.

## First Entry MGC+ Control Unit (CU) IP Configuration

The MCU is delivered with a default IP address: 129.254.4.8. At this point you cannot communicate with the MCU from the MGC Manager application, as the IP address is incorrect. You must change this IP address to the IP address appropriate for your site's network. There are three methods to modify the default IP address:

- Using the Compact Flash with an updated LAN.CFG file
- Using a cross-over hub cable and a laptop to connect to the MCU locally
- Using a keyboard and monitor attached to the MCU

### Using the Compact Flash Disk with the LAN.CFG File

The MCU is delivered with a Compact Flash disk that contains a LAN.cfg file with the default IP address. Using a USB to Compact Flash adaptor (supplied with the MGC+ accessory kit) connect to any PC and alter the LAN.cfg file.

#### To update the LAN.cfg File:

1. Insert the Compact Flash disk into the Compact Flash adaptor and using a text editor application, open the **LAN.cfg** file stored on the Compact Flash disk.
2. Using a text editor application, edit the following parameters:

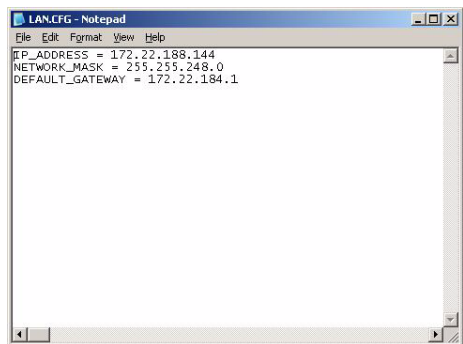

Table 2-1: IP Configuration Options

Option	Description
<i>IP Address</i>	The system displays the currently defined IP address. Enter the IP address allocated to the MCU by the network administrator.
<i>Subnet Mask</i>	Enter the Subnet Mask of the MCU.
<i>Default Gateway</i>	Enter the IP Address of the default gateway/router.



Make sure no blank spaces occur at the end of each line.

3. Save the changes in the LAN.cfg file.
4. Use the Microsoft *Unplug or Eject Hardware* procedure prior to removing the Flash disk.



Failure to stop the hardware properly can result in a corrupt Compact Flash disk. When the disk fails, a replacement is required.

5. Remove the Compact Flash disk from the reader.
6. Insert the Compact Flash disk into the Compact Flash slot of the MGC+ Control Module.
7. Press the **Reset** button on the MGC+ unit.  
The Options menu appears.
8. Press **1**, to *Change the MGC+ IP Settings*.



If no monitor is connected, the automatic default time-out (15 seconds) selects option 1.

The *Flash Memory* LED must be active and flash.

9. Press the **Eject** button.  
Once the message “1 File(s) copied” is displayed on screen, the *Flash Memory* LED no longer flashes.



Do not press the *Eject* button while the *Flash Memory* LED is flashing.

10. Remove the Compact Flash disk from the Compact Flash slot on the MGC+ Control Module and press the **Reset** button on the MGC+.
11. Connect the MCU to your site’s network.
12. Install the MGC Manager and start this application. For more information, see Chapter 3, “Starting the MGC Manager Application” on page 3-4.
13. In the MGC Manager, define a new MCU using the IP address you have entered in the LAN.CFG file. For more information, see Chapter 3, “Defining the MCU” on page 3-5.

## Using a Cross-over Hub Cable and a Laptop to Connect to the MCU Locally

1. Connect a cross-over hub cable between the laptop LAN connection to the LAN connection of the control unit on the rear panel of the MCU.
2. On the laptop *Start* menu, click **Control Panel ->Network Connection->Local Area Connection**.
3. In the *Local Area Connection - General* dialog box, click the **Properties** button.
4. In the *Local Area Connection Properties* dialog box, click **Use the following IP address**, and define the address of the laptop as part of the same network segment as the MCU. For example, 129.254.4.7.
5. Click **OK**.
6. Install the MGC Manager and start this application. For more information, see Chapter 3, “Starting the MGC Manager Application” on page 3-4.
7. Define the MCU using the default IP address (129.254.4.8). For more information, see Chapter 3, “Defining the MCU” on page 3-5.

8. In the MCUs list, double-click the MCU icon to connect to it.
9. Modify the IP address of the MCU unit as allocated by the network administrator. This is the IP address with which the MCU is identified on the LAN and not its definition in the MGC Manager application:
  - a. Right-click the *MCU* icon, and then click **IP Configuration**.

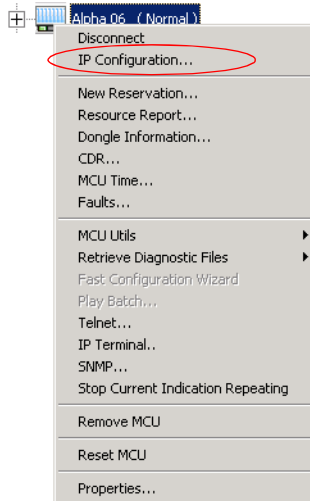

The *IP Configuration* dialog box opens.

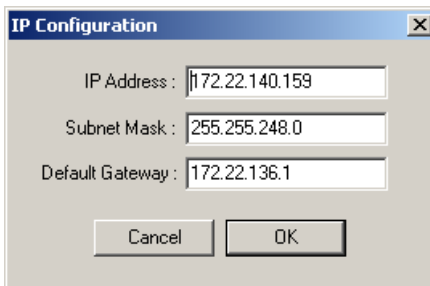

- b. The following parameters may be modified:
  - c. Click **OK**.
10. Press the **Reset** button on the MGC+ unit.
11. Disconnect the MCU from the local network that you have created.
12. Connect the MCU to your site's network.

Table 2-2: IP Configuration Options

Option	Description
<i>IP Address</i>	The system displays the currently defined IP address. Enter the IP address allocated to the MCU by the network administrator.
<i>Subnet Mask</i>	Enter the Subnet Mask of the MCU.
<i>Default Gateway</i>	Enter the IP Address of the default gateway/ router.

13. In the MGC Manager application, modify the MCU definition:
  - a. Right-click the *MCU* icon, and then click **Properties**.

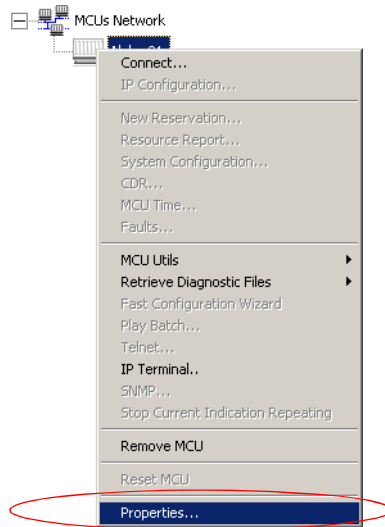

The MCU *Properties* dialog box opens.

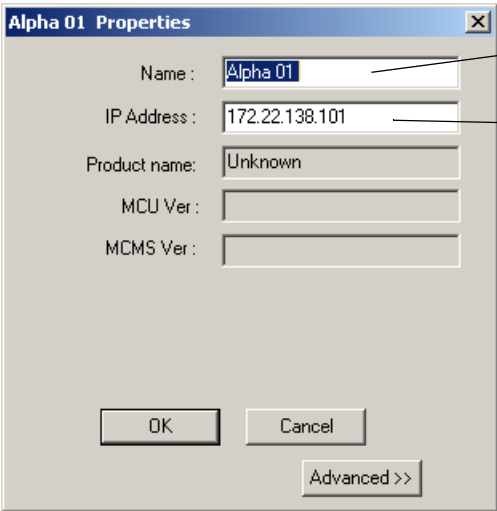

The current MCU name. To modify, type a new name

MCU IP address. Enter the IP address of the MCU as allocated by the network administrator

- b. Enter the IP address of the MCU as you have defined in the IP Configuration.
- c. Click **OK**.

14. Connect to the MCU.

## Using a Keyboard and Monitor Attached to the MGC+ unit

- 1. Access the Main Control Module rear I/O panel and connect the keyboard and the monitor to the appropriate ports.

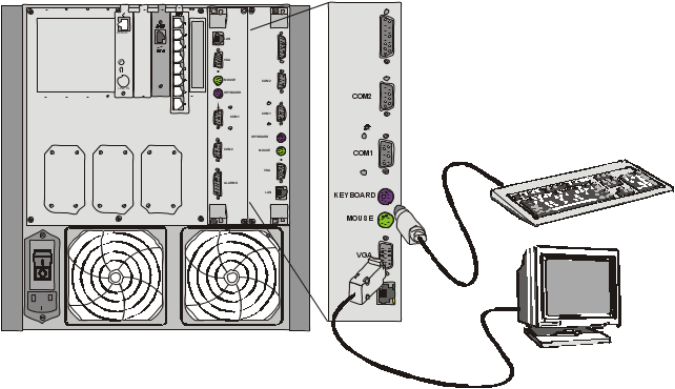

2. Press the **Reset** button on the MCU.  
The command line is displayed on the monitor.
3. Type `C:\>dir mcu\cfg` and press **Enter**.
4. Type `C:\>\mcu\cfg>edit lan.cfg` and press **Enter**.  
The *Edit* screen opens displaying the IP configuration parameters.
5. Move the cursor to the appropriate line and enter the new *IP Address*, as supplied by the network administrator.  
If required, modify the *Subnet Mask* and the *Default Gateway* values.
6. Save the new IP configuration and exit the DOS editor.
7. Press the **Reset** button on the MCU.
8. Connect the MCU to your local network.
9. Install the MGC Manager application and start this application. For more information, see Chapter 3, “Installing the MGC Manager” on page 3-2.
10. Define a new MCU using the address entered via the monitor and keyboard. For more information, see Chapter 3, “Defining the MCU” on page 3-5.  
The new MCU is added to the MCUs list.



Another method to connect to the MCU and modify its IP configuration is via a telephone line with a modem or directly via a serial connection. For details, see the MGC+ Administrator's Guide, Appendix C, “PPP Setup”.



---

# MGC+ Software Installation and Configuration

The MGC+50/MGC+100 requires basic configuration before you can start running conferences. You are required to configure the ReadManager IAM and MGC+ Control Unit (CU) blades on the MGC+.

## Initial ReadManager IAM Configuration

For entering system configuration settings and deploying the ReadManager IAM to your Network refer to the Polycom ReadManager IAM Getting Started Guide, Chapters 1 and 2.

## Installing the MGC Manager

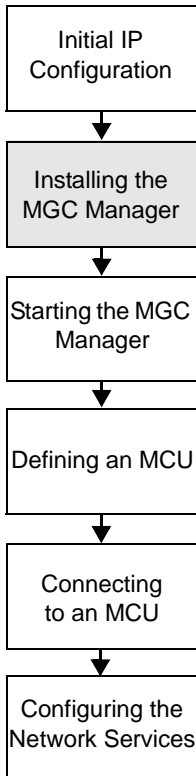

To configure the MGC+ unit to your environment, setup conferences and control the MGC+ unit you must install the MGC Manager software on a PC. A single MGC Manager-enabled PC can manage multiple MCUs.

During the installation, default Reservation templates are installed. The MGC unit is shipped with a Default IVR Service and Default Entry Queue Service. For information about restoring these services when upgrading MCU software, refer to the MGC Administrator's Guide, Chapter 5.

### To install the MGC Manager software:

1. Insert the software CD into the CD drive.
2. On the *Start* menu, click **Run**.  
The *Run* dialog box opens.
3. Type **D:\SETUP** (where D is the name of the CD drive), and then click **OK**.

The installation wizard starts and the *Software License Agreement* window opens.

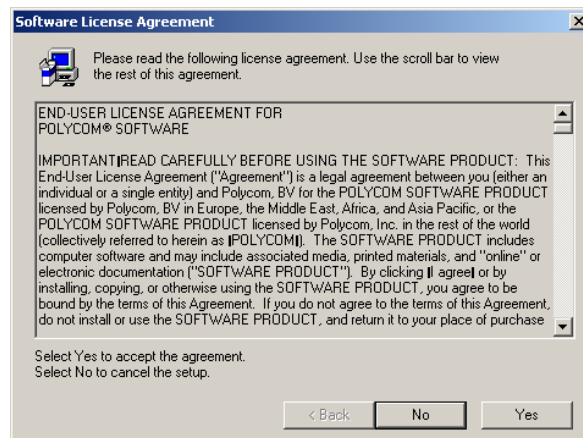

4. Click **Yes** to accept to the terms of the agreement or **No** to exit the installation.

If you clicked **Yes**, the *Welcome* window opens.

5. Click **Next**.

The *User Information* screen opens.

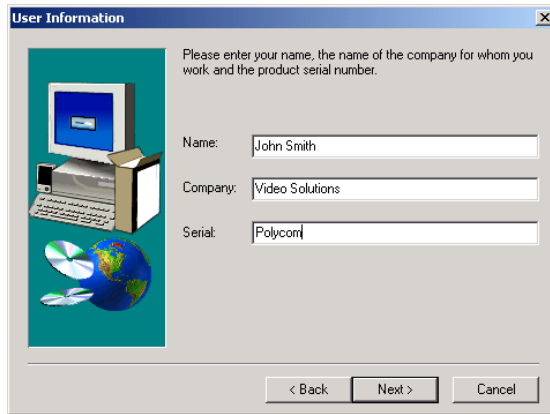

6. Enter your name and the name of your company in the appropriate boxes. For a standard installation, enter **Polycom** in the *Serial* box.
7. Click **Next**.
8. Follow the on-screen instructions to complete the installation process. At the end of the installation procedure, the *Setup Complete* window opens.
9. Click **Finish**.  
The MGC Manager software is now installed on your computer.

# Starting the MGC Manager Application

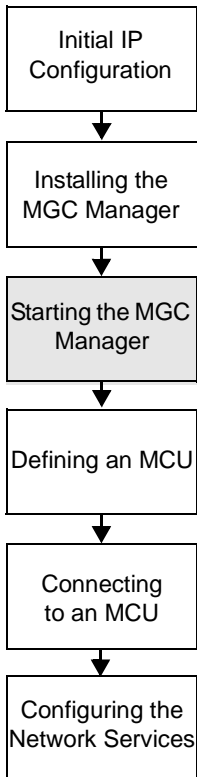

The MGC Manager application is designed to set up and monitor multipoint video conferences, and to perform system configuration activities for the MGC+ Multipoint Control Units (MCUs) to which it connects.

**To start the MGC Manager application:**

- On the *Start - Programs* menu, select **MGC Manager ver 9.0**, and then click **MGC Manager ver 9.0**.

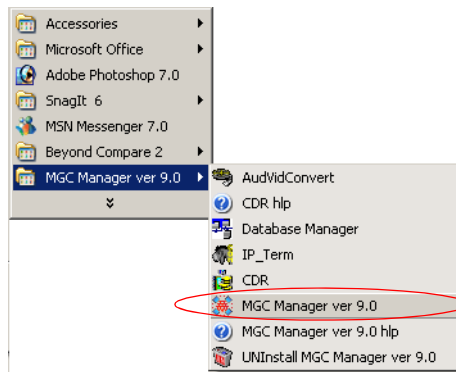

The *MGC Manager* main window opens

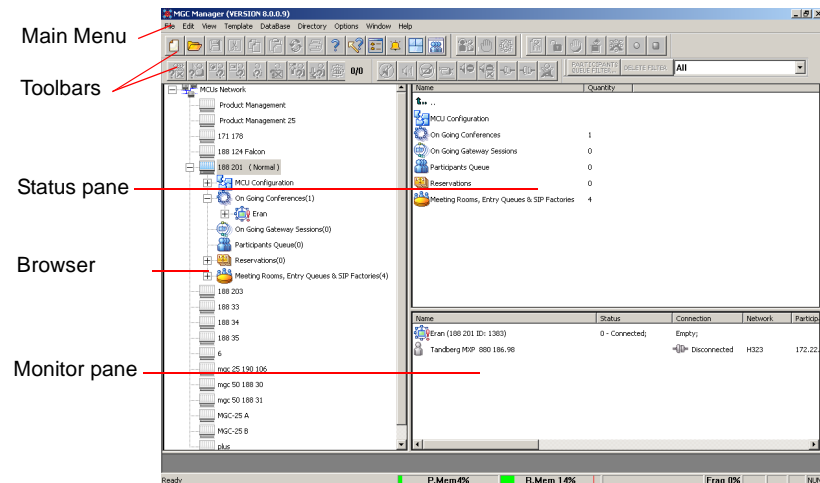

## Defining the MCU

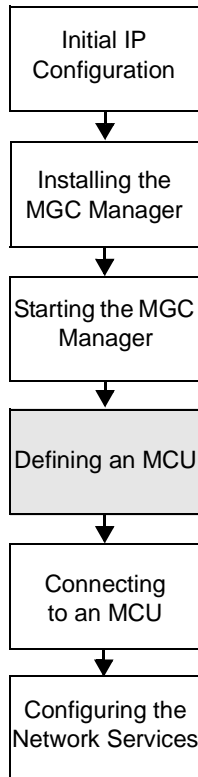

To manage and control the MGC+ unit it must be added to the MCUs network list in the MGC Manager application.



The MGC unit has to be installed and its IP address properly configured before defining its connection parameters in the MGC Manager application. For details, see Chapter 2, “First Entry MGC+ Control Unit (CU) IP Configuration” on page 2-18.

### To define an MCU Connection:

1. In the *Browser* pane, right-click the *MCUs Network* icon, and then click **New MCU**.



The *Add MCU* dialog box opens.

2. In the *Name* box, enter the name of the MCU. Specify a name that clearly identifies the MCU.

3. In the *IP Address* box, enter the IP Address of the MCU.



The IP address should be identical to the one configured during the Initial IP Configuration.

4. Click **OK**.  
The *Add MCU* dialog box closes.  
A new icon with the specified MCU name appears in the *Browser* pane listed below the *MCUs Network* icon.

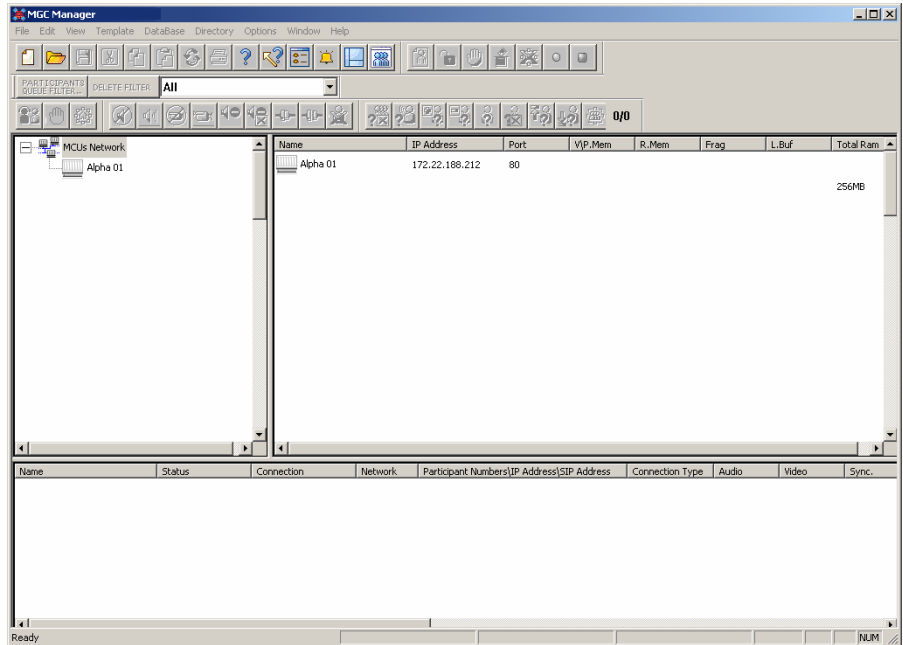

## Connecting to an MCU

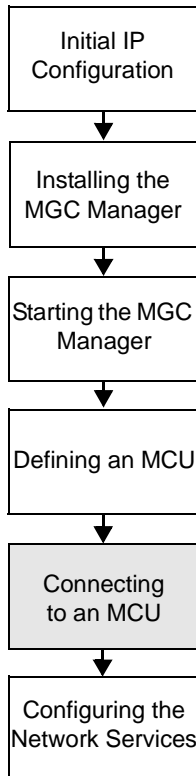

Once the MCU connection parameters are defined, the MGC Manager can be connected to it. The MGC Manager reports the status of each MCU connection.

### To connect the operator workstation to an MCU:

1. In the *Browser* pane, double-click the *MCUs Network* icon, or expand the *MCUs Network* icon.  
A list of MCUs appears below the *MCUs Network* icon.
2. Double-click the *MCU* icon.  
Alternatively, right click the *MCU* icon to which you want to connect, and then click **Connect**.

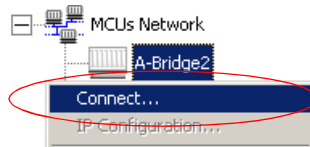

The *Logon* dialog box opens.

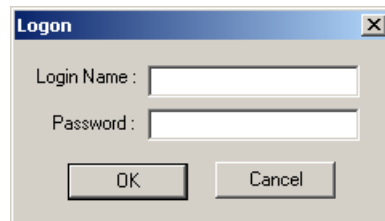

3. Enter your *Login Name* and *Password*, and then click **OK**.

Note that each MCU is initially configured with a default operator whose *Login* and *Password* are both POLYCOM. Additional operators can be defined. For more details, see the *MGC Administrator's Guide*, Chapter 6.

## Configuring the Network Services

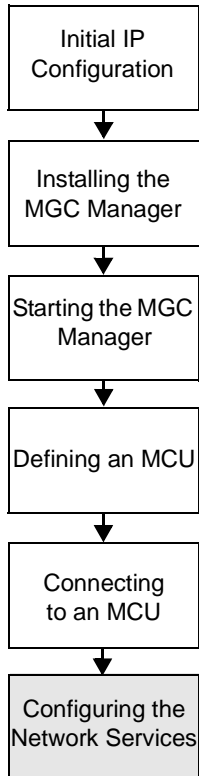

The Network Services include the parameters of the networks connected to the MCU. If no Network Services have been configured, depending on your system configuration, the appropriate Network Service must be configured. This section describes the configuration of both IP and ISDN networks.



For information about defining T1-CAS, MPI, NFAS ISDN, Leased lines ISDN and additional ISDN and IP Network Services, or modifying existing Network Services, refer to the *MGC Administrator's Guide, Chapter 3*.

### ISDN Network Service

The Net-2/4/8 card installed in the MCU interfaces between the MGC unit and the ISDN switch. The ISDN Network Service is used to define the properties of the switch and the ISDN lines running from the switch to the ISDN card. Each group of ISDN lines having the same characteristics and originating from the same ISDN switch, will be assigned to the same ISDN Network Service.

### IP Network Service

The IP Network Service defines the properties of the IP network connected to the IP+ cards (installed in the MCU). Several of the network components are used by both H.323 and SIP endpoints to connect to the conference, and the same IP+ card is used for H.323 and SIP connections. One IP Network Service, therefore, can be defined for both H.323 and SIP environments as well as an H.323-only or a SIP-only Network Service.

### Defining the Network Services

The first time you connect to the MGC+ unit from the MGC Manager, the system automatically detects that no Network Service is defined in your system and automatically displays the *Network Configuration Wizard* to let you configure the IP and ISDN Network Services.

If the system detect an ISDN only connection to the MCU, only the *ISDN Configuration* dialog box opens. If an IP-only connection is detected, only the *IP Configuration* dialog box opens.



You can always access the *Fast Configuration Wizard* by right-clicking the MCU icon.



**To define the Network Service:**

1. In the *Network Configuration Wizard* window, click either **IP** or **ISDN**. The the configuration process can start in any order.

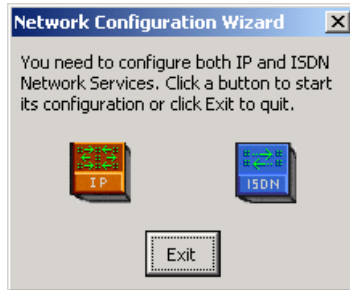

If you have selected IP, the *IP Configuration* dialog box opens.

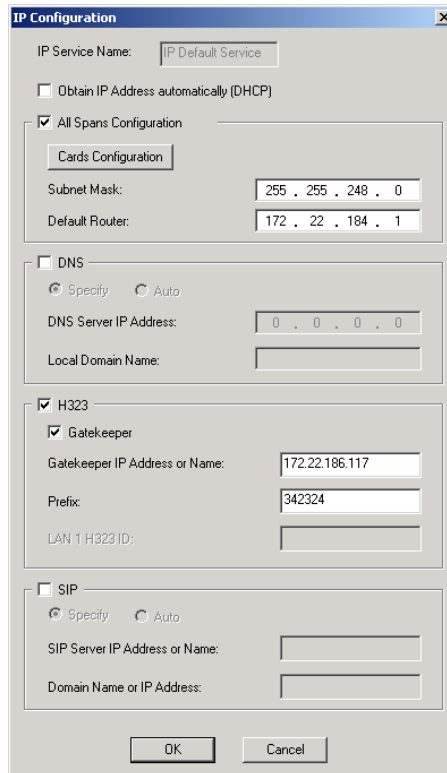

## 2. Define the following parameters:



To route Meet Me H.323 dial-in participants to their conferences using a IP Network Service prefix as part of the dialing string, some gatekeepers require the configuration of an IP Network Service prefix prior to its definition in the gatekeeper. With Polycom PathNavigator, the IP Network Service prefix automatically registers with the gatekeeper and does not require prior definition.

Table 3-1: IP Configuration Parameters

Field	Description
<i>IP Service Name</i>	Enter a name using up to 20 characters, or use the default name (IP Default Service).
<i>Obtain IP Address automatically (DHCP)</i>	Select this check box to use a DHCP server for automatic assignment and tracking of IP addresses to the conference devices. Do not select this check box if you need to: <ul style="list-style-type: none"> <li>Establish a static IP address, for example, when working with a firewall and you need to translate an internal IP address, that must be static, with an external one.</li> <li>When dialing in directly to the card, using the card's IP address.</li> </ul>
<i>All Spans Configuration</i>	Select this check box to indicate that a LAN span is connected to the IP+ card in the MCU and to define the properties of this card.

Table 3-1: IP Configuration Parameters (Continued)

Field	Description
<p><i>Cards Configuration</i></p>	<p>Click this button to automatically detect the IP address and Alias (if known) of the IP+ cards installed on the MCU.</p>  <p>The IP+ card type and its slot number, IP address and alias are listed. When the <i>Obtain IP Address automatically (DHCP)</i> check box is selected, the IP address of the card appears as 0.0.0.0.</p> <p><b>To configure a specific IP+ card:</b>          Highlighting and then double clicking on any card.</p>  <p>Enter or change the <i>IP address</i>, and add the card's <i>Alias</i> if required and click <b>OK</b>.</p>
<p><i>Subnet Mask</i></p>	<p>Enter the subnet mask of the MCU's IP+ card. If the DHCP is used, the subnet mask is automatically retrieved from the DHCP server and cannot be modified. For more details, see the MGC Administrators Guide, Chapter 3, "Defining an IP Network Service".</p>

Table 3-1: IP Configuration Parameters (Continued)

Field	Description
<i>Default Router</i>	Enter the IP address of the default router. If a DHCP is used, the IP address of the default router is automatically retrieved from the DHCP server and cannot be modified.
<b>DNS</b>	Select this check box to indicate that a DNS server is used in the network. Then select: <ul style="list-style-type: none"> <li>• <b>Specify</b> - Select this option to enter the IP address of the DNS server.</li> <li>• <b>Auto</b> - select this option to automatically detect the primary DNS IP address, provided the DNS Server is defined in the DHCP and if the <i>DHCP -obtain IP Address automatically</i> check box was selected.</li> </ul>
<i>DNS Server IP Address</i>	If <i>Specify</i> was selected, enter the IP address of the primary DNS server to be used.
<i>Local Domain Name</i>	Enter the domain name where the MCU is installed. The name of the domain includes the host part of URL or URI (the part of the host's address that appears after the at sign (@), or in a URL the part following the <i>www.</i> prefix), for example, <i>polycom.com</i> . This field is used both for SIP proxy registration purposes and DNS resolution and therefore it is required if you are using DNS servers in this service.
<b>H.323</b>	Select this option to allow H.323 participants to connect to the MCU using this service.
<i>Gatekeeper</i>	If a gatekeeper is used, select the <i>Gatekeeper</i> check box to define its properties.
<i>Gatekeeper IP Address or Name</i>	Enter either the gatekeeper's host name (if the DNS server is used), or IP address.

Table 3-1: IP Configuration Parameters (Continued)

Field	Description
<i>Prefix</i>	<p>Enter a number to be used by H.323 participants to dial to the MCU as part of the dial-in string.</p> <p>Enter <b>789</b> to use the default Entry Queues and Meeting Rooms shipped with the MGC+ unit without modifying their properties.</p> <p>When PathNavigator is used, this prefix automatically registers with the gatekeeper. When another gatekeeper is used, this prefix must also be defined in the gatekeeper.</p>
<b>SIP</b>	<p>Select this check box to indicate that SIP participants can connect to the MCU using this service. Then select:</p> <ul style="list-style-type: none"> <li>• <b>Specify</b> - to manually define the SIP server.</li> <li>• <b>Auto</b> - to automatically detect the SIP server's IP address if a DHCP or if a DNS Server is defined.</li> </ul>
<i>SIP Server IP Address or Name</i>	<p>If SIP-Specify is selected, and a DHCP is not used, enter either the IP address of the preferred SIP server or its host name (if a DNS server is used).</p>
<i>Domain Name or IP Address</i>	<p>Conferences and Entry Queues can be registered in the proxy in the format <i>user@host</i>. for example, EQ1@polycom.com, where EQ1 is the user part and polycom.com is the host part.</p> <p>When dialing to a conference or Entry Queue, the SIP server expects to receive the host either as domain name or as an IP address.</p> <p>The domain name is used for identifying the SIP server in the appropriate domain according to the host part in the dialed string. For example, when the call to EQ1@polycom.com reaches the outbound proxy, this proxy looks for the SIP server in the polycom.com domain to which it will forward the call.</p> <p>When this call arrives at the SIP server in polycom.com, the server looks for the registered user (EQ1) and forwards the call to this Entry Queue or conference.</p>

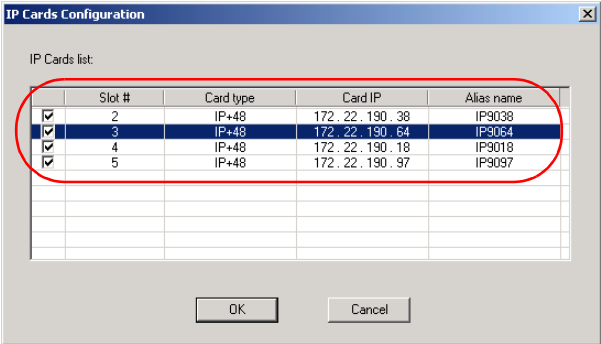
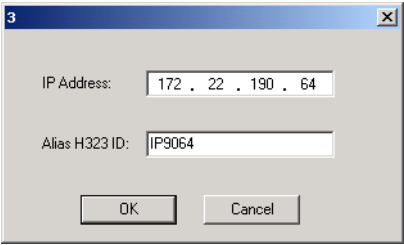
- Click **OK**.  
If your system supports only IP networks, a confirmation message is displayed.

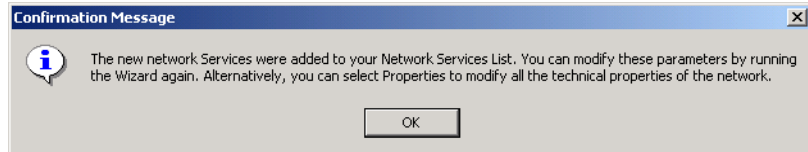

- Click **OK**.



If you are defining only the IP Network Service, the Network Configuration dialog box closes and the new IP Network Service appears in the *IP Network Services* list.

If you are defining both IP and ISDN Network Services, the *Network Configuration Wizard* dialog box is displayed.

**To configure an ISDN Network Service:**

- Click the **ISDN** button.

The *ISDN Configuration* dialog box opens.

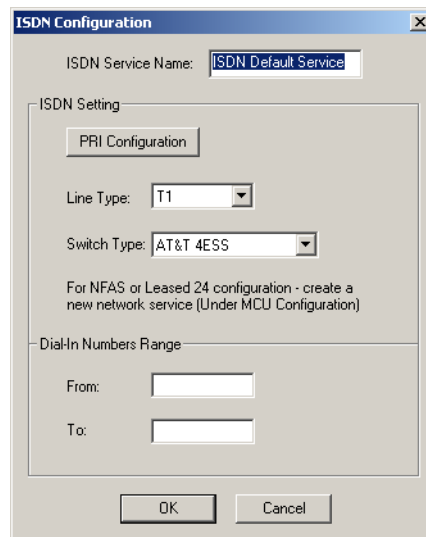

- In the *ISDN Service Name* box, enter a name or use the default name (ISDN Default Service).

7. Click **PRI Configuration** to define any ISDN span.  
The *ISDN Cards configuration* window appears.

Slot #	Card type	PRI 1	PRI 2	PRI 3	PRI 4	PRI 5	PRI 6	PRI 7	PRI 8
2	NET-8	<input checked="" type="checkbox"/>	<input type="checkbox"/>	<input type="checkbox"/>	<input type="checkbox"/>	<input type="checkbox"/>	<input type="checkbox"/>	<input type="checkbox"/>	<input type="checkbox"/>
3	NET-2	<input type="checkbox"/>	<input type="checkbox"/>	<input type="checkbox"/>	<input type="checkbox"/>	<input type="checkbox"/>	<input type="checkbox"/>	<input type="checkbox"/>	<input type="checkbox"/>

ISDN (Net) cards present on the MCU are automatically listed together with their slot number.

- a. Select any PRI span by selecting the relevant check box.
  - b. Click **OK** when complete.
8. In the *Line Type* list, select either **T1** (usually in the U.S., T1 has 23 B channels + 1 D channel), or **E1** (usually in Europe, E1 has 30 B channels + 1 D channel).
  9. In the *Switch Type* list, select the brand and revision level of equipment installed in the telephone company's central office.
  10. In the *Dial-In Numbers Range* boxes, enter the phone numbers to be used for dial-in connections as allocated to the MCU by your service provider. Enter the first and last numbers in the range of phone numbers.
  11. Click **OK**.  
A confirmation message is displayed.
  12. Click **OK**.

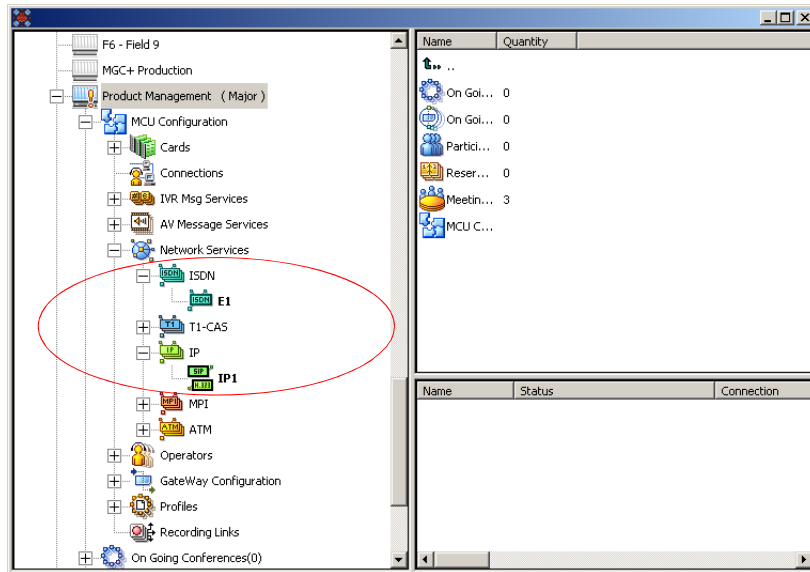

For advanced settings, see the *MGC Administrator's Guide, Chapter 3*.

The Network Services definition is complete, and the *Network Configuration* dialog box closes. The new Network Services appear in the *IP Network Services and the ISDN Network Services* lists.



The following icons are used to indicate the IP Network Service type:

Table 3-2: IP Network Service Icons

Icon	Description
	The Network Service supports both SIP and H.323 connections.
	The Network Service supports only H.323 connections.
	The Network Service supports only SIP connections.

By default, the new Network Services are set as the system default. When defining additional Network Services for IP or ISDN connections these defaults can be changed. For more details, see the *MGC Administrator's Guide, Chapter 3*.



---

# About Conferences

Different conference types are available according to their initiation modes: reservationless conferences and scheduled conferences.

## On-Demand (Reservation-less) Conferencing

Reservation-less conferencing enables participants to immediately start and connect to an On Going Conference from their endpoint, with no advanced scheduling. The MGC Manager offers two methods for Reservation-less conferencing:

- Ad Hoc Conferencing
- Meeting Rooms

### Ad Hoc Conferencing

In Ad Hoc conferencing, participants connect to an Ad Hoc-enabled Entry Queue. An Entry Queue is a special routing lobby to which one or several dial-in numbers are assigned. The participants are prompted for the destination conference Numeric ID. If no conference with a matching Numeric ID is running, but the participant is authorized to create a conference, the system creates a new On Going Conference. The new conference is created according to the conference parameters defined in a Profile assigned to the Entry Queue. All other participants connect directly to the newly created conference. With this method, only the conference Profile is created once and is used repeatedly to create numerous conferences.

This conferencing method is often used to globally enable all employees in an organization to start On Going Conferences from their endpoints, without having to define the conference parameters for each employee and for each conference.

When authentication with external database application is configured for the Entry Queue and for the conference, the MCU verifies with the external

database application whether a conference with a specific Numeric ID may be started. This is the method used with Windows Messenger and Office Communicator to initiate multipoint Video or Audio conferences.

For more information about Ad Hoc conferencing, see the *MGC Manager User's Guide, Volume II, Chapter 3*.

### **Meeting Rooms**

Meeting Rooms are conferences created once, with no starting date or time, no reserved resources and it can be activated as many times as required. The Meeting Room remains in passive mode until the first participant connects to it and activates the conference. To start the conference you simply let the participants know the start date and time, dial-in number and the Numeric ID of the conference. No prior booking is required. The conference returns to passive mode once the conference ends and remains in the MCU memory until the next activation. In this mode, a Meeting Room is usually defined for each of the employees in your organization. This may require tedious work when your organization includes many employees, and it also loads the MCU memory with all the saved Meeting Rooms.

## **Scheduled Conferences**

You can define a conference to start at a certain date and time or to start immediately. Scheduled conferences run once and are then deleted from the MCU memory. For scheduled conferences, the MCU reserves resources for the conference participants, provided the participant endpoints are defined during the conference definition. You can define conferences without defining their participants and let participants connect to the conference as long as there are resources available.

## Video Conference Attributes

There are four general types of video conferences:

- **Video Switching** - A conference in which all participants use the same video and audio formats. Whenever a participant starts to speak, the participant appears on all endpoints in full screen display as the conference is a voice activated video switching conference.
- **Transcoding** (requires Video card) - A conference in which participants use different video, audio and data formats, while maintaining the highest video and audio capability each participant can achieve with his or her codec. Like video switching, the current speaker is displayed on all endpoints in full screen.
- **Continuous Presence** (requires Video card) - A conference in which several participants can be viewed simultaneously. In this type of conference, the highest video, audio and data quality for each participant depends on the participants endpoint capabilities.

In a traditional Continuous Presence conference, each participant uses a different video port on the Video card. This method enables such features as full Transcoding per participant, Personal Layouts (individualized Continuous Presence layouts per participant) and maintenance of overall video and audio quality for the conference—even when participants with lower capabilities connect. However, this method limits the number of Continuous Presence participants to the number of ports on the Video card, which is six.

- **Conference On Port** (requires Video card) - A conferencing method suitable for large Continuous Presence conferences or when several Continuous Presence conferences are running on the MCU.

In Conference On Port, all conference participants use a single video port. This method allows for more than six participants to join a Continuous Presence conference and allows for up to six Continuous Presence conferences to be run on the MCU.

In a Conference on Port conference, a video layout can be selected for the conference, but all the participants, including the speaker, view the same layout and the same participants. The Personal layout selection is not available in Conference on Port and the video quality is determined by the highest common video parameters and by the video line rate.

## Entry Queue

An Entry Queue is a special routing lobby that is used for routing participants to their target conference. One or several dial-in numbers are assigned to the Entry Queue, and they are used by callers to all conferences. Once callers are connected to the Entry Queue, they are routed and connected to the target conferences if they provide the appropriate conference IDs and passwords (optional). Both Video and Audio Only conferences can be accessed from an Entry Queue. For information about defining an Entry Queue, see Chapter 6, “Defining a New Audio Only Entry Queue” on page 6-1 or see Chapter 7, “Defining a New Video Entry Queue” on page 7-1.

---

# Basic Operations

This chapter describes how to start, monitor and manage On Going Conferences.

## Reservation Templates

A Reservation template includes the conference parameters, such as the conference media (audio, video), video session, line rate, video protocol and other video parameters, IVR Service and more. The reservation can include the conference participant parameters.

### Default Reservation Templates

There are five default Reservation templates installed with the MGC Manager:

- **Video-Switch:** Video Switching at 384 Kbps
- **SW CP:** Software Continuous Presence (IP) at 384 Kbps
- **Default-Audio:** Audio Only with default IVR Service
- **Default\_Video:** Continuous Presence Conference at 384 Kbps
- **Default\_COP:** Conference On Port at 384 Kbps



In order to run a **Default\_Video** or **Default\_COP** conference, the Video+ card and MCU Version 5.6 or later must be installed in your system.

Using the default Reservation templates, you can schedule a conference to start immediately (On Going Conference), or to start automatically at a predefined date and time (Reservation).

## Starting a Conference

You can start an On Going Conference from one of the default Reservation templates provided with the system or you can define a new On Going Conference. For more details about defining new conferences, see *MGC Manager User's Guide*, Chapter 4, "Defining a new Audio Only Conference" or *MGC Manager User's Guide*, Chapter 4, "Defining a New Video Conference".

### To start an On Going Conference from a default Reservation template:

1. Connect to an MCU. For more details, see "Connecting to an MCU" on page 3-11.
2. The *Default* folder in the *Reservations Database* window opens automatically when you open the MGC Manager. Otherwise, access this window by clicking **Reservations in AccordDB** from the *Window* menu.

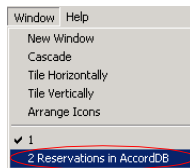

The *Reservations Database* window opens.



If the *Reservations in Database* window did not appear automatically and is not included in the Window menu options, reopen this window using the login procedure described in *MGC Manager User's Guide*, Volume I, Chapter 3 "MGC Manager Basics".

You can move the *Reservations in Database* window by dragging the blue title bar. You can also resize the window by clicking an edge and dragging it.

3. In the *Reservations in Database* window, expand the *Default* folder to display the list of default Reservation templates.

- Right-click the icon of the *Reservations in Database* template and click **Start Immediately**. If more than one MCU is connected, select the name of the MCU to run the conference from the pop-up list.

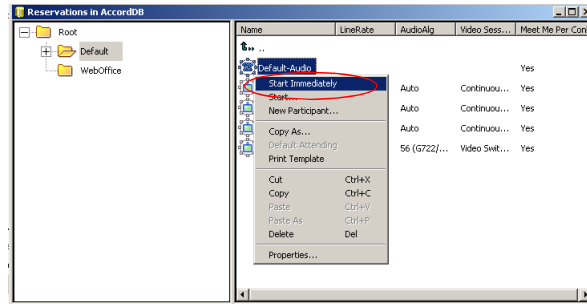

If the MGC Manager application is connected to several MCUs, select the MCU name as well as the reservation template.

The conference begins and appears in the list of On Going Conferences.

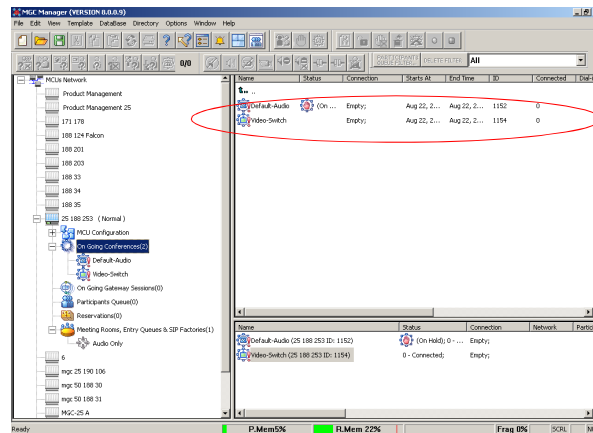

If no participants were defined in the Reservation template, the conference starts but contains no participants.

## Viewing the Conference Dial-in Properties

The dial-in numbers and passwords needed to enter a conference, including IP Network Prefixes and Numeric IDs appear in the MGC Manager *Status* pane.

**To view the list of On Going Conferences and their dial-in numbers:**

- Expand the *MCU* tree, and then click the *On Going Conferences* icon.

The list of On Going Conferences with their Numeric IDs and dial-in numbers are displayed in the *Status* pane.

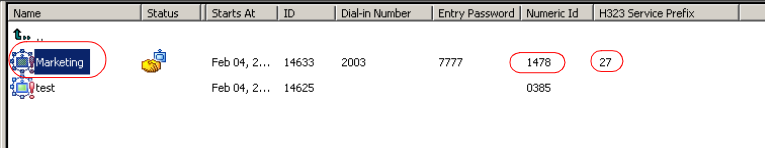

Name	Status	Starts At	ID	Dial-in Number	Entry Password	Numeric Id	H323 Service Prefix
Marketing		Feb 04, 2...	14633	2003	7777	1478	27
test		Feb 04, 2...	14625			0385	

In some configurations, the ISDN/PSTN number is truncated by the PBX, and you must add the appropriate prefix to the dial-in number that is displayed in the *Status* pane.



## Connecting to a Conference/Entry Queue

Defined dial-in participants can connect to any conference by dialing the conference dialing string (ISDN, H.323 or SIP). The MCU identifies their CLI or IP address (as defined in the participant properties) and routes them to the appropriate conference. Dial-out participants must be defined in the conference.

Undefined participants can connect directly to conferences defined as Meet Me per Conference or Meeting Room by dialing its dial-in string. If required, the participants enter the conference password before joining the conference.

Undefined participants can also connect to a single-dial Entry Queue to access conferences. The dialing methods are the same as for the conference. Once participants connect to the Entry Queue, they are routed to their conference according to the conference numeric ID or password that they enter.

In the default templates, just the Audio Only template is defined with *Entry Queue Access*. To create a new video conference with *Entry Queue Access*, see Chapter 7, “Creating an On Going Video Conference” on page 7-6.

## Dialing-in to a Conference/Entry Queue

Undefined dial-in participants can access the conference using the following methods:

### **ISDN/PSTN Participants**

Audio Only and ISDN Video participants dial the conference/Entry Queue ISDN dial-in number, as assigned to the conference by the operator or automatically by the MCU. The dial-in number can be viewed in the MGC Manager Status pane.

### **H.323 Participants**

When a gatekeeper is present, H.323 participants dial: the [IP Network Service Prefix] and [conference/Entry Queue Numeric ID or name] for example, if the Network Service prefix is **925** and the Conference Numeric ID is **1222**, participants will dial **9251222**. If participants dial only the Network Service Prefix, or if the wrong numeric ID is dialed, participants will be automatically routed to the default Entry Queue if one is defined. For more information about the IP Network Service Prefix, see Chapter 3.

For example, if the IP Network Service prefix is 27, the conference Numeric ID is 1478 and the conference name is 'MARKETING', the participant can dial 271478 or 27MARKETING. IF the Entry Queue name is EQ1 and its numeric ID is 3000, the participant can dial 273000 or 27EQ1 to access the MR. IF only 27 is dialed, participants are be routed to the default Entry Queue (if one is defined).

When no gatekeeper is present, H.323 participants dial the IP address of the MCU's IP card, followed by ## and the conference/Entry Queue Numeric ID. For example, if the IP card address is 172.22.190.162, participants will enter 172.22.190.162##1478 to access the conference, or 172.22.190.162##3000 to access the Entry Queue.

If no Entry Queue /conference numeric ID or if the wrong numeric ID is entered, participants are be routed to the default Entry Queue (if one is defined). If no default entry queue is defined in the system, the call is disconnected.

### **SIP participants**

When a new conference reservation or Entry Queue is defined the conference or Entry Queue registers with the SIP proxy.

SIP participants dial the conference/Entry Queue URI using the format: Conference or Entry Queue name@domain name.

For example, MRO1@polycom.com, or EQ1@polycom.com.

Usually for SIP conferencing, an Ad Hoc Entry Queue is used. In this scenario, the first participant dials the Entry Queue and creates a new conference, while the other conference participants dial directly to the conference using the conference name or Numeric ID.

When dialing from a Microsoft Windows Messenger endpoint that does not have DTMF capabilities, the first participant (who creates the new conference in Ad Hoc Conferencing) enters the Entry Queue name followed by the target conference name and the numeric ID in the format:

EQ Name (Target Conference Name)(Target Conference Numeric ID).

For example, **EQ1(sales)(12345)**. In this example, the Entry Queue name is **EQ1**, and a new On Going Conference by the name **sales** with the Numeric ID **12345** will be created on the MCU.



You do not need to add the domain name to the conference name, as it is automatically added by Microsoft Windows Messenger when the request is sent to the SIP server.

## Monitoring On Going Conferences

You can monitor conferences and perform various operations while conferences are running.

Monitoring involves viewing the status of On Going Conferences and the status of their participants.

Three levels of monitoring are available with the MGC Manager:

- *General Monitoring* - You can monitor the general status of all the On Going Conferences and their participants in the MGC Manager main window.
- *Conference Level Monitoring* - You can view additional information regarding the conference using the *Conference - Properties* option.
- *Participant Level Monitoring* - You can view detailed information on the participant's status using the *Participant - Properties* option.

When an operator is available to attend participants, you can view the status of participants in the *Participants Queue* window. For more information about the *Participants Queue*, see the *MGC Manager User's Guide, Volume I, Chapter 8*.

Operations can be performed at the conference level or at the participant level. For example, you can terminate a conference before its scheduled ending or you can extend its duration. You can also disconnect an individual participant while the conference is in progress, or temporarily mute transmission to and from a site so that the other participants can hold a private discussion. You can also connect dial-out participants during the conference and add a new participant while the conference is in session.

### General Monitoring

Monitoring a conference enables you to keep track of its participants and its progress. When monitoring a conference, you can check whether all its participants are correctly connected and whether errors and faults have occurred.

The MGC Manager allows you to monitor several On Going Conferences simultaneously. The On Going Conference information is easily available and clearly represented.

## Monitoring a Conference

When you click a conference icon, the conference appears in the *Status* pane. However, to get more details regarding the conference and participants statuses or to monitor several conferences simultaneously, it is advised to monitor the conferences in the *Monitor* pane.



Automatic Monitoring of conferences is available. For details, see the *MGC Manager User's Guide, Volume I, Chapter 5*.

You can display the list of On Going Conferences in the *Status* pane so you can view their dial-in numbers and Numeric IDs while monitoring the conferences with their participants in the *Monitor* pane.

### Displaying the conference and participants statuses in the *Monitor* pane:

1. Expand the *MCU* tree.
2. Expand the *On Going Conferences* tree.
3. In the On Going Conferences list, right-click the conference to monitor, and then click **Monitor** to view all the conference participants in the Monitor pane.

Alternatively, on the conference right-click menu, click **Monitor Filter** to view only participants of the selected filtering status.

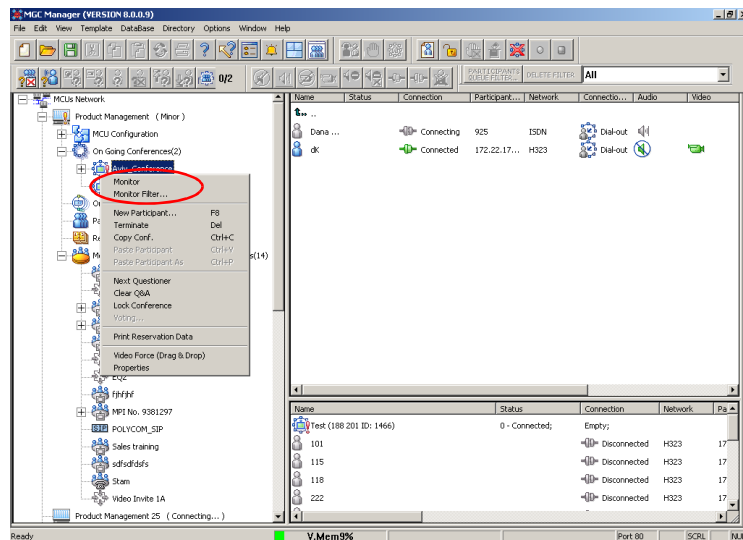

The *Participant Monitoring Filter* dialog box opens.

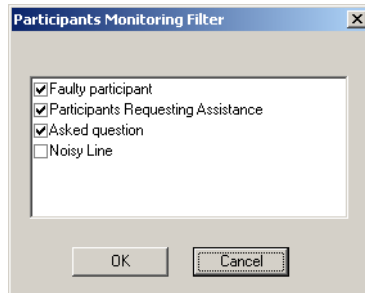

4. Select the appropriate check boxes that indicate the statuses to monitor. The following statuses may be selected:

*Table 5-1: Participant Statuses to be Monitored*

<b>Filtering Option</b>	<b>Description</b>
<i>Faulty participant</i>	Participants who have problems connecting to the conference.
<i>Participants Requesting Assistance</i>	Participants who have requested the operator's assistance and have yet to be assisted by the operator.
<i>Asked question</i>	Participants who wanted to ask questions, were added to the Question-and-Answer Queue and are now waiting for their turn to ask a question.
<i>Noisy Line</i>	Participants who the MCU detected as having noisy lines.

The conference and participant details appear in the *Monitor* pane.

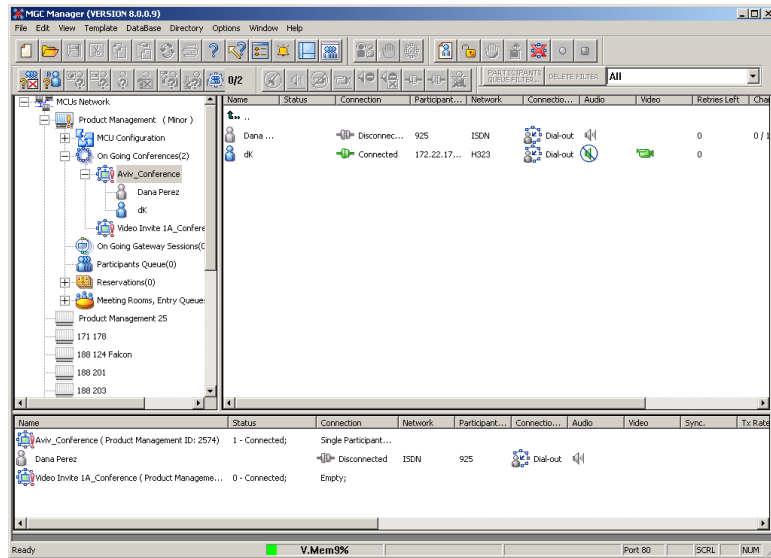

The *Status* and *Monitor* panes take the form of a table. Each row represents a conference or a participant. Each column represents a parameter that is being monitored. The *Conference Name*, *Status*, *Phone#*, *Connection Type*, *Retries Left*, *Channel#* and *Bonding* fields also appear in the *Status* pane.



You can modify the order of columns in the *Monitor* and *Status* panes by moving the column heading(s) to the desired location in the table header. The data in the *Monitor* and *Status* tables can be sorted according to a selected column. Clicking on a column heading sorts the table data in descending order. Clicking on the same column heading a second time sorts the data in ascending order.

Additional information about monitoring participants and conferences is described in the *MGC Manager User's Guide, Volume I, Chapter 5*.

### Listing Participants in the Browser and Status Panes

You can view the list of participants currently connected to the conference in the *Browser*, *Status* and *Monitor* panes.

**To view the list of participants in the *Browser* pane:**

1. Expand the *On Going Conferences* or *Reservations* tree.

- Expand the On Going Conference or Reservation to list its participants. The participants are listed below the conference or Reservation.

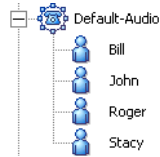

Different icons are used to indicate the participant roles and their connection status. For details, see the *MGC Manager User's Guide, Volume I, Chapter 5*.

#### To list the participants in the *Status* pane:

- Expand the *On Going Conferences* or *Reservations* tree.
- Double-click the icon of the On Going Conference or Reservation whose participants you want to list. The participants are listed in the *Status* pane.

#### To list the participants in the *Status* pane:

- Expand the *On Going Conferences* or *Reservations* tree to display the list of On Going Conferences or Reservations.
- Double-click the icon of the On Going Conference or Reservation whose participants you want to list. The participants are listed in the *Status* pane.

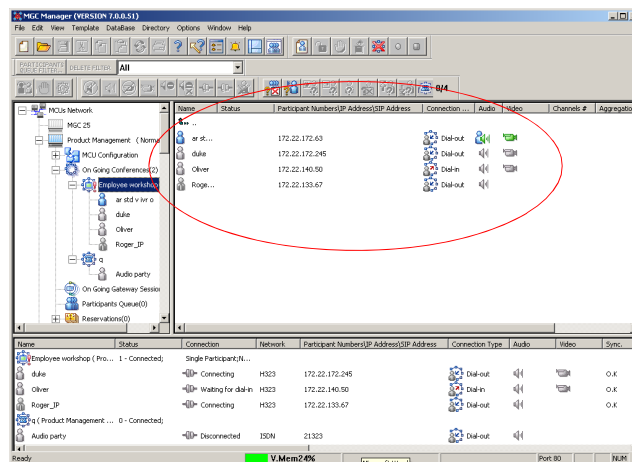

## Participant Level Monitoring

In addition to the data that appears in the *Status* and the *Monitor* panes, you can view detailed information about the connection parameters and status of each of the conference participants. This is especially useful if there is a problem during the connection of the participant to the conference.

### To check the properties of a participant:

- In the *Status* pane, the *Browser* pane or the *Monitor* pane, double-click the participant icon. Alternatively, right-click the participant icon, and then click **Properties**.

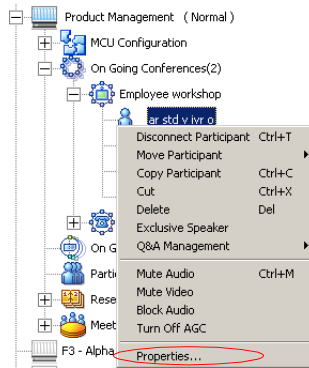

The *Participant's Properties* dialog box opens, displaying the following tabs: *Identification*, *Advanced*, *Connection Info1*, *Connection Info2*, *Resource Details*, *Disconnection Cause*, *H221 (ISDN)/H245 (IP)* and *Video Sources*. These tabs contain information that is relevant only to the participant's status while the conference is running and are mainly used for monitoring when there are connection problems.

The Participant Properties can be displayed for all connected participants or disconnected defined participants. Undefined dial-in participants who disconnect from the conference are removed from the *Participants* list and cannot be monitored.

For a description of these tabs, refer to the *MGC Manager User's Guide, Volume I, Chapter 5*.



## Operations Performed During On Going Conferences

The following operations can be performed during On Going Conferences:

- Adding a new participant to a conference
- Connecting/Disconnecting participants
- Muting/Unmuting participants
- Locking/Unlocking the conference
- Changing the conference duration
- Terminating the conference manually
- Changing the Video Layout in a Continuous Presence conference

Additional operations performed during On Going Conferences are described in the *MGC Manager User's Guide, Volume I, Chapter 6*.

### Adding a Participant to a Conference

#### Defining Dial-out Participants

You can manually add dial-out participants to the conference.

The participant properties change according to the participant type and network connection.



The following procedure assumes that the default participant parameters will be used. Therefore, only the parameters that you must define are described here. For a detailed description of the all participant parameters, refer to the *MGC Manager User's Guide, Volume I, Chapter 4*.

**To add a new participant to a Conference:**

1. List the On Going Conferences.
2. Right-click the icon of the conference to which to add a participant, and then click **New Participant**. Alternatively, click the conference icon, and then click the **New Participant** button on the *Conference Toolbar*.

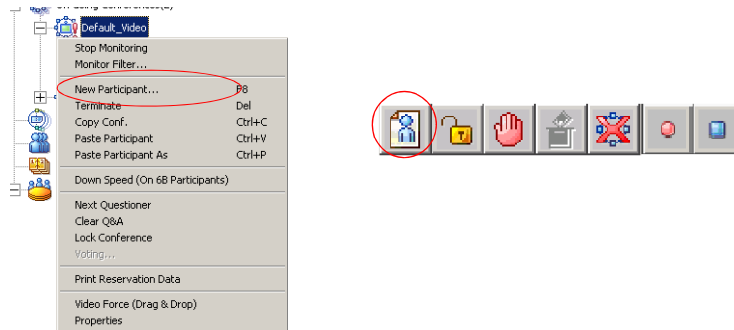

The *Properties - Identification* dialog box opens.

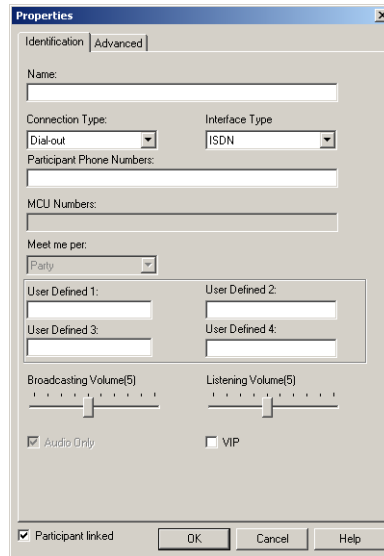

ISDN/Telephone Participant

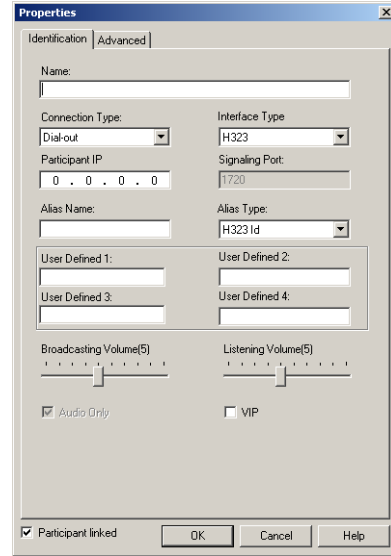

H.323 (VoIP) Participant

SIP Participant



The *Identification* parameters change according to the selected *Interface Type*.

3. In the *Name* box, enter the participant's name.
4. For video participants using H.221 aggregation, enter the phone numbers separated by semicolons.  
For example, for a 2B participant: 9251921;9251922. If using Bonding (both numbers are the same), enter the number once. Example: 9251921.
5. In the *Connection Type* box, select **Dial-out** if the MCU/operator calls the participant.
6. In the *Interface Type* box, select the Network Protocol used to connect the participant to the conference: **ISDN**, **H.323** or **SIP**.
7. Define the participant properties as follows:
  - a. If you are defining an **ISDN** participant:  
In the *Participant Phone Numbers* box, enter the participant's number.

- b. If you are defining an **H.323** participant:  
In the *Participant IP* box, enter the IP address of the participant's endpoint.  
  
Alternatively, in the *Alias Name* field, enter the Alias of the endpoint as registered with the gatekeeper and then select the Alias Type. Only H323 ID (digits and letters) and E.164 (only digits) are supported. Use this option if a gatekeeper is defined in the H.323 Network Service.
  - c. If you are defining a **SIP** participant:  
In the *SIP Address* box, enter the endpoint address in the format: *[user name]@[domain]*.  
Note that the SIP URI adheres to URI rules: no spaces or special characters such as commas, quotation marks, inverted tags and so forth in either the name or the domain part.
8. In the *User Defined* fields, enter general information about the participant, if required.
  9. If you are defining an *Audio Only* participant, click the **Audio Only** check box. If you are adding a participant to an Audio Only conference, this option is automatically selected and cannot be cleared.
  10. The system is set to automatically save the participant to the local data base. Clear this check box to cancel the save operation.
  11. Click **OK** to add the participant to the conference.



If you add a participant who has the same name, phone number or IP address of another participant in a concurrent conference, the *Participants Scheduling Conflicts* window opens. For details, see the *MGC Manager User's Guide, Volume I, Chapter 4*.

**To add a pre-defined participant to a conference:**

1. Expand the *MCU* icon to display its options.
2. Double-click the *On Going Conferences* icon, right-click the name of the desired conference, and then click **Properties**.  
The *Conference Properties* dialog box opens.

- Click the **Participants** tab to add participants to the conference. The *Properties - Participants* dialog box opens.

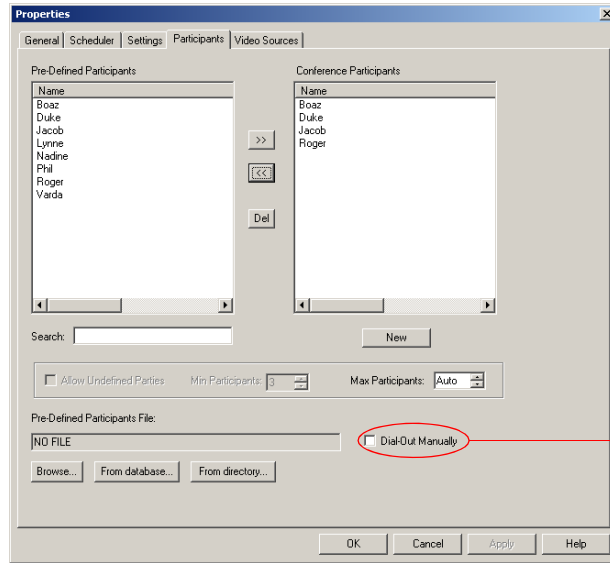

Select this check box to designate an operator- controlled dial-out conference connection.

- In the *Pre-Defined Participants* list, select the participants to add and then click the >> button.
- Alternatively, you can define a new participant by clicking the **New** button.

## Making Dial-Out Connections

When the *Dial-Out Manually* option is selected for the conference, the operator connects the dial-out participants to the conference. Also when a participant is disconnected from the conference, you can reconnect the participant to the conference.

### To manually establish a Dial-out connection:

- In the *Monitor* pane, *Status* pane or *Browser* pane, right-click the participant icon, and then click **Connect Participant**.

Alternatively, click the *Participant* icon, and then click the **Connect** button on the *Participant Toolbar*.



You can connect several participants in one operation using the standard Windows conventions for multiple selection.

During the connection attempt, the participant status changes to *Connecting* in the *Connection* column and then changes to *Connected* once the participant's connection is established.



The MCU can be configured to automatically reconnect participants who were accidentally disconnected from the conference. For more details, see the MGC Administrator's Guide, chapter 5.

## Disconnecting Participants

When a participant does not need to continue in a conference, you can disconnecting or delete the participant.

When you disconnect a participant, the resources assigned to the participant remain allocated and the participant's parameters remain in the system memory. This allows you to reconnect the participant if necessary.

Deleting a participant completely removes the participant's definition from the conference and releases the resources allocated to the participant. Therefore, to reconnect a participant who was deleted from the conference, you have to re-define the parameters as if he/she were a new participant.

### To disconnect a participant:

- In the *Monitor* pane, *Status* pane or *Browser* pane, right-click the participant icon, and then click **Disconnect Participant**.

Alternatively, click the *Participant* icon, and then click the **Disconnect** button on the *Participant Toolbar*.

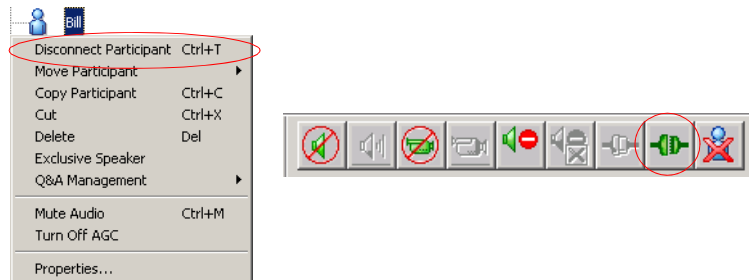

The participant is disconnected from the conference. The connection icon changes to disconnected and the indication *Disconnected* appears in the *Connection* column.

### To delete a participant:

1. In the *Monitor* pane, *Status* pane or *Browser* pane, right-click the participant icon, and then click **Delete**.

Alternatively, click the *Participant* icon, and then click the **Delete** button on the *Participant Toolbar*.

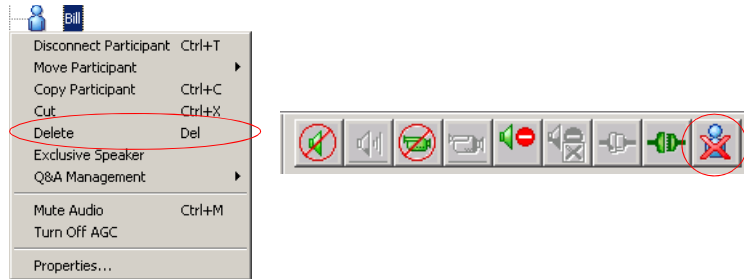

A confirmation dialog box appears.

2. Click **YES** to confirm, or **NO** to cancel the operation.

## Muting a Participant

Occasionally, a conference organizer may want to silence the audio and video channel of a particular participant from part of an On Going Conference.

The MGC Manager enables you to mute a participant's audio and/or video signals. A participant whose audio or video signal is muted hears and sees the other participants. However, the other participants cannot hear or see the muted participant.

Alternatively, participants' audio and video signals can be muted from their own codecs, through the endpoint's application.



### To mute a participant using MGC Manager:

- In the *Monitor* or the *Status* pane, right-click the participant icon, and then click **Mute Audio** to mute the audio signal, or click **Mute Video** to mute the video signal.

Alternatively, click the *Participant* icon and then click the **Mute Audio** button or **Mute Video** button on the *Participant Toolbar*.

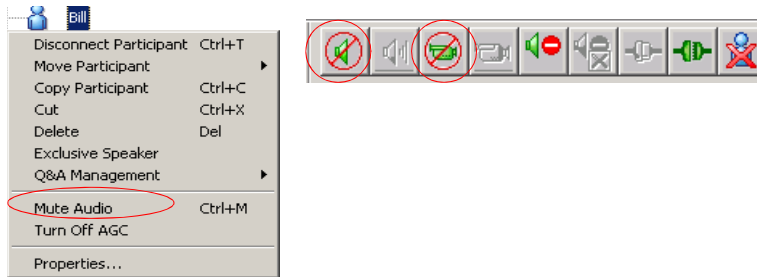

The menu changes to *UnMute Audio*, or *UnMute Video* (respectively).

The appropriate Audio  or Video  icon appears in the *Audio* or *Video* columns of the *Monitor* and *Status* panes.

For information about additional muting options, refer to the *MGC Manager User's Guide, Volume I, Chapter 6*.

## Locking and Unlocking a Conference

You can lock or unlock On Going Conferences and thus control access of undefined dial-in participants to these conferences. The Lock/Unlock option is dynamic and can be applied any time before or during the conference. This feature is used to:

- Limit the number of undefined dial-in participants connecting to the conference in order to save resources.
- Prevent other participants from connecting to the conference once all the required participants have already been connected.

**To Lock or Unlock a conference:**

- Right-click the conference icon, and then click **Lock Conference** or **Unlock Conference**.

Alternatively, click the *Conference* icon, and then click the **Lock** button or **Unlock** button on the *Conference Toolbar*.

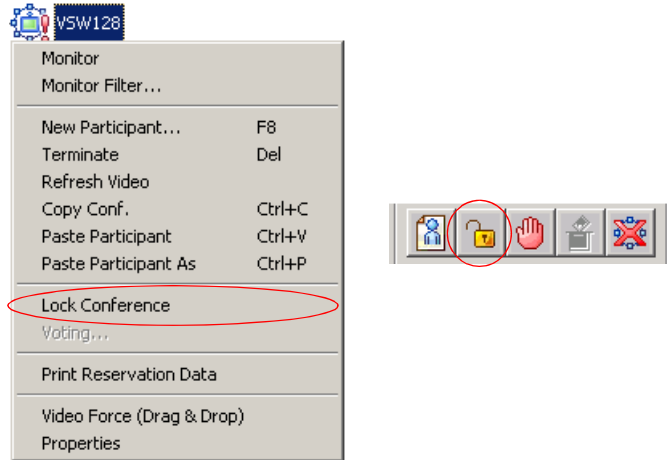

**Changing the Conference Duration**

It is often necessary to extend the duration of a conference or terminate a conference before its scheduled completion time. The conference can be extended either manually or automatically or terminated. To automatically extend or terminate a conference, refer to the *MGC Manager User's Guide, Volume I, Chapter 6*.

You can change the conference duration even after the conference has started.

### To change the duration of an On Going Conference:

1. In the *Browser*, *Monitor* or *Status* panes, right-click the conference icon, and then click **Properties**.

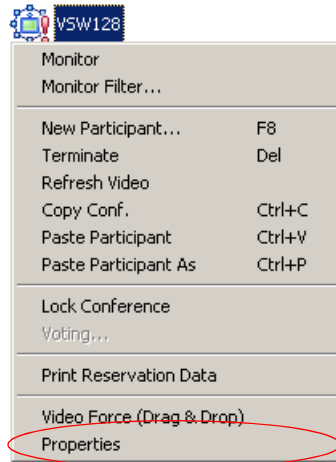

The *Conference Properties* dialog box opens.

2. Click the **Scheduler** tab.

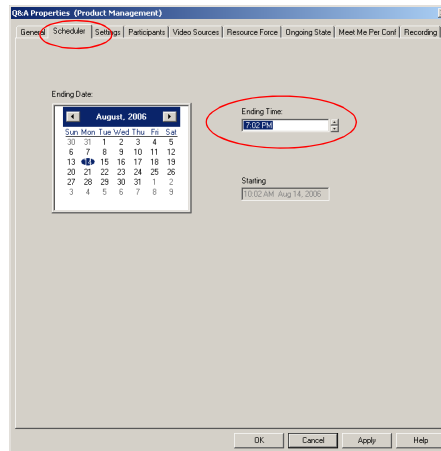

3. Modify the conference *Ending Time*.

4. Click **OK**.  
The *Conference Properties* dialog box closes. The conference's duration is changed.

### Terminating a Conference Manually

You can manually end the conference before its scheduled end time. Usually, you will use this option when all the participants disconnected from the conference, or if the meeting organizer has requested it.

#### To terminate a conference manually:

1. In the *Browser*, *Monitor* or *Status* panes, right-click the On Going Conference, and then click **Terminate**.

Alternatively, click the *Conference* icon, and then click the **Terminate** button on the *Conference Toolbar*.

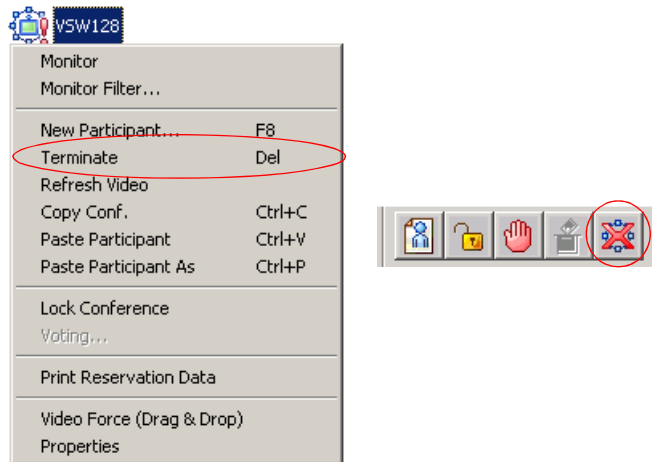

A confirmation dialog box opens.

2. Click **Yes**.  
The conference ends. The conference icon is removed from the *On Going Conferences* list.

## Changing the Layout in a Continuous Presence Conference

You can select a particular Video Layout (that is a specific arrangement of video windows on the screens) or *Auto Layout* during On Going Continuous Presence conferences.

1. In the *Browser* pane, expand the On Going Conference list.
2. Right-click the On Going Conference icon, and then click **Properties**. The *Conference Properties* dialog box opens.
3. Click the **Video Sources** tab. The *Conference Properties - Video Sources* dialog box opens.

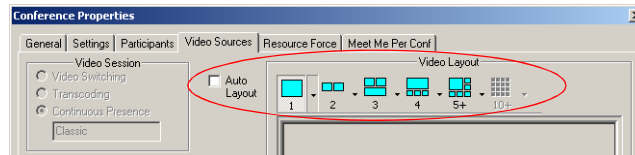

4. To enable *Auto Layout*, select the *Auto Layout* check box. The system automatically and dynamically applies layouts with the appropriate number of display windows, according to the number of connected video participants.
5. To select a particular video layout, clear the *Auto Layout* check box if it is selected.
  - 5a. Determine the number of windows to appear on the screen, and click the arrow next to the numbered *Video Layout* icon that displays the available video layouts for the selected number of windows.
  - 5b. Click the desired Video Layout.
6. Click the **Apply** button to save these changes and modify additional properties or click **OK** to confirm and exit the *Properties* dialog box.
7. For information about *Auto Layout*, *Personal Layout*, *Presentation Mode*, *Lecture Mode* and *Visual Effects*, see the *MGC Manager User's Guide, Volume I, Chapter 6*.



---

## Defining a New Audio Conference

The following entities can be defined for Audio Only conferencing:

- Define an Audio Only Entry Queue
- Define an On Going Audio Only Conference
- Define an Audio Only Meeting Room

### Defining a New Audio Only Entry Queue

An Audio Only Entry Queue is used to rout Audio Only participants to Audio Only conferences, and it is usually defined in Audio Only MCUs. Video Entry Queues can be used by Audio Only participants in a unified conferencing environment. To define a Video Entry Queue, see “Defining a New Video Entry Queue” on page 7-1.

**To define a new Audio Only Entry Queue:**

1. Expand the *MCU* icon to display its options.
2. Right-click the *Meeting Rooms, Entry queues & SIP Factories* icon, and then click **New Entry Queue**.

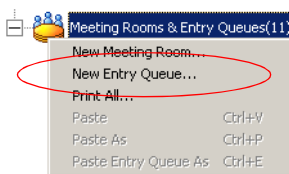

The *Entry Queue Properties* dialog box opens.

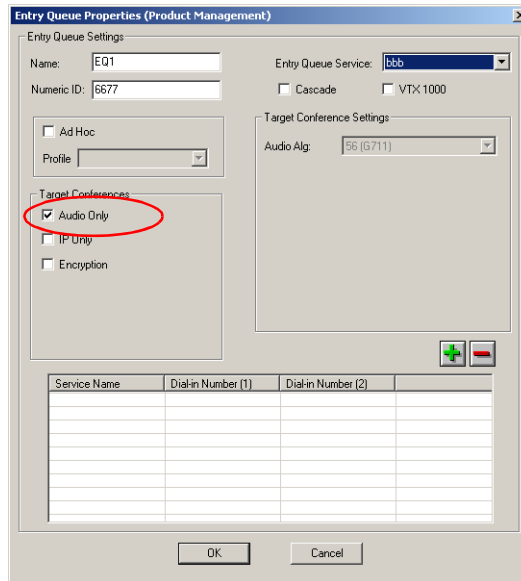

3. In the *Name* box, specify a name for the Entry Queue using up to 20 characters.
4. In the *Numeric ID* box, enter a unique per MCU number (default length is four digits), or leave this field empty to let the NCU assign one when the Entry Queue definition is completed.
5. In the *Entry Queue Service* box, select the Entry Queue Service that will be used to play voice messages that will guide participants through their connection process. Leave this field blank to use the default Entry Queue Service if one is defined.
6. Select the *Audio Only* check box.
7. To allow VTX 1000 users to connect to the Entry Queue, select the **VTX 1000** check box.
8. Select the **IP Only** check box to define an IP-Only conference. This enables the Audio Algorithm selection for the target conference.



9. If you selected the *IP Only* option, you can select the Entry Queue to be Encrypted, and you can select the audio algorithm to use by VoIP participants to connect to the target conference.



For Ad Hoc Entry Queue definition, see the MGC User's Guide, Volume II, Chapter 3.

10. Add a dial-in number to the Entry Queue by clicking the plus [+] button.



Dial-in numbers are relevant to ISDN and T1-CAS participants only.

11. Up to 16 dial-in phone numbers may be assigned to the Entry Queue.
  - If no dial-in number is assigned to the Entry Queue, the system assigns a dial-in number from the dial-in numbers ranges defined in the ISDN Network Service. The number is assigned only when the Entry Queue definition is saved by clicking the **OK** button
  - H.323 and SIP participants dial the Entry Queue directly as described in see Chapter 5, “Connecting to a Conference/Entry Queue” on page 5-5.
12. Enter the name of the ISDN/T1-CAS Network Service exactly as it is defined in the Network Services list (the system is case sensitive).
13. Enter the first dial-in number to be assigned to the Entry Queue. This number must be part of the dial-in numbers range defined for the selected ISDN/T1-CAS Network Service. For more details regarding the dial-in numbers range, see the *MGC Administrator's Guide, Chapter 3*.
14. If required, enter the second dial-in number to be assigned to the Entry Queue.
15. Click **OK**.  
The dial-in number is added to the table in the *Entry Queue Properties*.
16. In the *Entry Queue Properties* dialog box, click **OK** to complete the Entry Queue definition.

The New Entry Queue is added to the *Meeting Rooms*, *Entry Queues* & *SIP Factories* list.

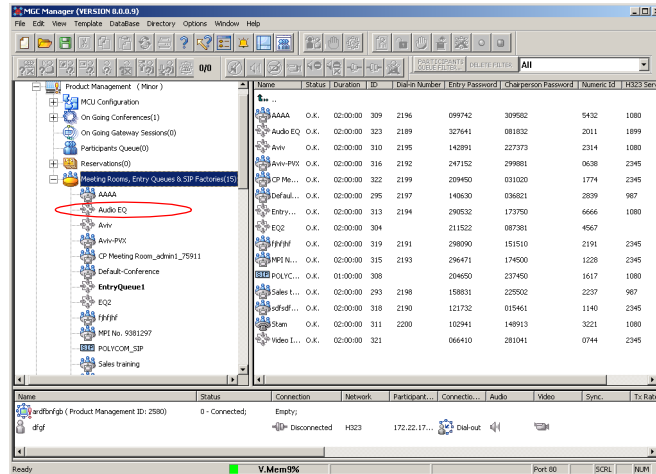

To set the Audio Only Entry Queue as the default Entry Queue, see Chapter 7, “Creating an On Going Video Conference” on page 7-6.

## Defining an On Going Audio Conference

The following procedure describes the main parameters required to define an Audio conference without Encryption. For a detailed description of all parameters, see the *MGC Manager User's Guide VoicePlus Edition, Chapter 2*.

### To define a new On Going Audio Conference:

1. Expand the *MCU* tree.
2. Right-click the *On Going Conferences* icon, and then click **New Conference**.

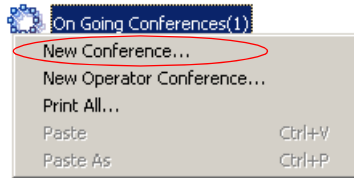

The *Conference Properties - General* dialog box opens.

 A screenshot of the "Properties (Product Management)" dialog box, General tab. The dialog has several sections:
 

- General Information:** Name, Duration (2:00), Billing, MCU (Product Management), Conf. Entry Password, Web/Chairperson Password, Numeric ID.
- Access Options:** Checkboxes for "Entry Queue Access" and "Meet Me Per Conf".
- Conference Type:** Radio buttons for Standard (selected), Meeting Room, and Operator.
- Media:** Radio buttons for Audio (selected) and Video, Audio.
- Supported Network:** Radio buttons for IP (selected) and IP, ISDN, ATM, MPI.
- Remarks:** A text field with an "Update Remark" button.
- Remarks History:** A list box showing a history of remarks.

 At the bottom are buttons for "OK", "Cancel", "Apply", and "Help".



The MCU can be set to *Audio Look & Feel* mode in which all video related parameters are hidden in all dialog boxes and menus. This is intended for Audio bridges. The *Audio Look & Feel* mode is set in the *Options* menu. For more details, refer to the MGC Administrator's Guide, Chapter 5.

3. If *Audio Look & Feel* is not set for the MCU, in the *Media* box, select **Audio** to define an Audio Only conference and hide the video properties. If *Audio Look & Feel* is set for the system, the conference is automatically set to **Audio** and all the video parameters are hidden.
4. In the *Name* box, enter the conference name.
5. Change the *Conference Duration* if required.
6. In the *Conf. Entry Password* box, enter the conference password (digits only).



The default minimum number of digits for the conference password is 4, but the number of digits can be set in the system.cfg file. For additional information refer to the *MGC Administrators Guide, Chapter 5*.

7. In the *Web/Chairperson Password* box, enter the Chairperson password (if required).
8. In the *Numeric ID* box, enter the desired conference Numeric ID.
9. In the *User Defined Fields* boxes, enter the requested information (if required). The *User Defined* fields are displayed only if the *Show User Defined Fields in Conference Parameters* option is selected in the Database Manager.

10. Click the **Settings** tab.  
The *Properties - Settings* dialog box opens.

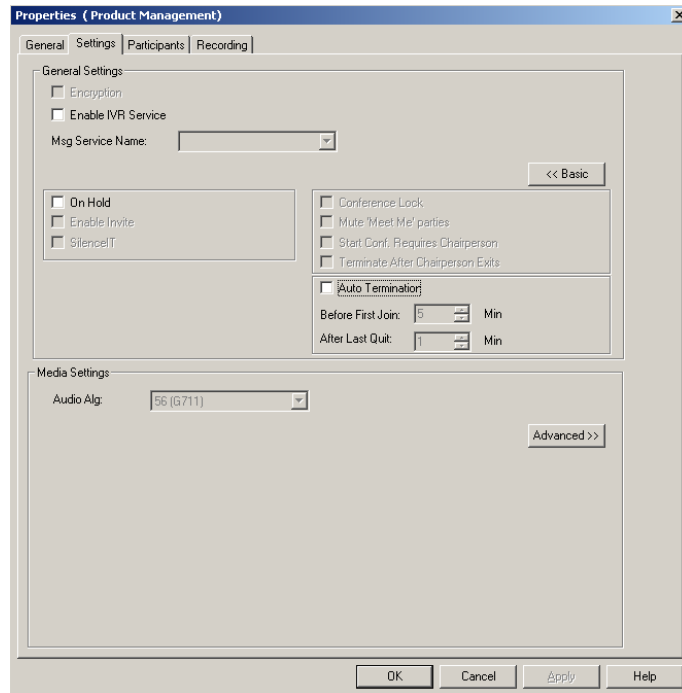

Parameters in the *Conference Properties - Settings* dialog box are grouped in two main panes: *General Settings* and *Media Settings*. By default, only the Basic settings in these panes are displayed when you first open the dialog box. You can click the **Advanced (>>)** button to view and modify the additional settings. In most conference definitions you do not need to modify the Advanced parameters because the MGC Manager uses default values, or uses the optimal parameters based on the endpoint's capabilities.

11. Select the **Enable IVR Service** check box to assign an IVR Service to the conference. The IVR Service includes a set of voice messages and prompts that assist participants to connect to the conference.
12. In the *Msg Service Name* box, select an IVR service or leave blank to use the default IVR service. The MGC+50/+100 is shipped with a pre-configured IVR service.

13. If you want to set up advanced parameters, click the **Advanced** button on either pane. For more information, see the *MGC Manager User's Guide VoicePlus Edition, Chapter 2*.
14. Click the **Participants** tab to add predefined participants to the conference. For more information, see Chapter 5, "Adding a Participant to a Conference" on page 5-13.



If you are defining a dial-in conference with only undefined participants, this step may be skipped.

15. To complete the conference definition procedure, click **OK** from any of the *Conference Properties* tabs. The *Properties* dialog box closes.

The new conference is added to the *On Going Conferences* list in the *Browser* pane. The conference starts immediately.

## Defining a New Audio Only Meeting Room

A Meeting Room is a conference reservation without allocated resources whose default duration is set to 2 hours. A Meeting Room is created once, and can be activated as many times as required.

### To define a New Meeting Room:

1. Expand the *MCU* tree to display its options.
2. Right-click the *Meeting Rooms, Entry Queues & SIP Factories* icon, and then click **New Meeting Room**.

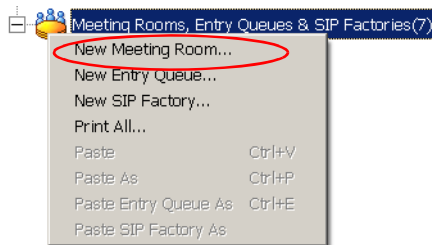

The *Conference Properties* dialog box opens.

3. Define the parameters in the *General* and *Settings* tabs as described in steps 3-15 in “Defining an On Going Audio Conference” on page 6-5.
4. Click the **Participants** tab.  
The *Conference Properties - Participants* tab is displayed.

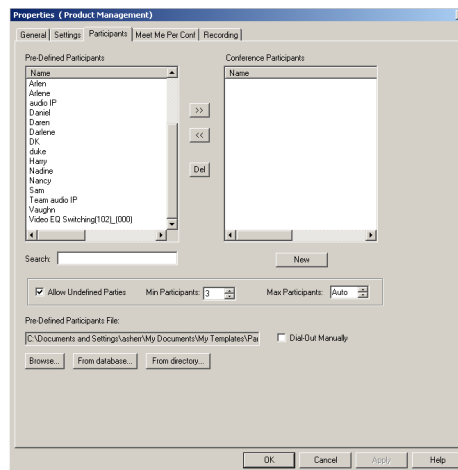

5. Usually Meeting Rooms include undefined participants. However, it is possible to add defined participants from the *Pre-Defined Participants* list, by selecting the participants and then clicking the >> button. Alternatively, you can define a new participant by clicking the **New** button.
6. In the *Min Participants* box, define the total number of participants for which the system reserves resources. This number should include the number of defined participants as well as undefined participants. If you enter **0**, no resources will be reserved for the conference. However, participants will be able to connect to the conference if there are available resources.
7. In the *Max Participants* box, enter the total number of participants who can connect to the conference at one time, including both the defined and undefined participants. This option saves resources for other conferences. When set to *Auto*, the maximum number of participants is determined by the maximum number of participants in a conference supported by the MCU, or by the availability of the MCU resources.
8. Click the **Meet Me Per Conf** tab.  
The *Properties - Meet Me Per Conf* dialog box opens.

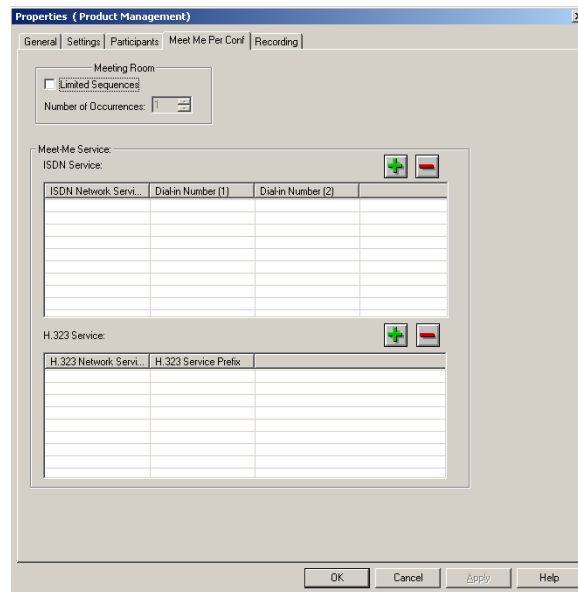



9. Select the **Limited Sequences** check box, to limit the number of times that the Meeting Room can be activated. If this check box is cleared, the Meeting Room can be activated an unlimited number of times.
10. In the *Number of Occurrences* field, determine the number of times the Meeting Room can be activated: **1** means that the conference can be activated once, and then it will be deleted from the system. 2 or more means that the conference can be activated that number of times, and the conference remains in sleep mode in between recurrences.
11. In the *Meet Me ISDN Service* pane, click the **Plus (+)** button to define dial-in numbers for this conference. If you do not define a dial-in number, the system will assign a dial-in number from the range of dial-in numbers defined in the Network Service.
12. The *H.323 Network Service* prefix is automatically assigned to the conference after the Meeting Room is saved on the MCU. It is then displayed in the first row of the *Meet Me H.323 Service* table. To add prefixes for H.323 participants to dial using other H.323 Network Services, click the **Plus (+)** button.
13. Click **OK**.  
The Meeting Room is added to the *Meeting Rooms, Entry Queues and SIP Factories* list.





---

## Defining a New Video Conference

The following entities can be defined for Video conferencing:

- Define a Video Entry Queue
- Start an On Going Conference
- Set up a Meeting Room

### Defining a New Video Entry Queue

You can create several Entry Queues, each with a different set of parameters, to match the parameters of target conferences. If an Entry Queue is set to Video Switching, the destination conference audio, video and line rate settings must be identical to the Entry Queue settings, or the participants will not be able to move to the target conferences.

In Entry Queues defined as *Transcoding* or *Continuous Presence*, the line rate and video setting are the maximum set for participants' connections. However, participants can connect at a lower rate using their endpoint capabilities. The line rate and the video parameters used for connections to the Entry Queue are maintained when moving to the target conference.

If you have not already done so, define the Entry Queue Service in the IVR Services before defining the Entry Queue. For more details, see the *MGC Manager User's Guide, Volume II, Chapter 2*.

Entry Queues can be encrypted. For more details, see the *MGC Manager User's Guide, Volume II, Chapter 1*.

**To define a new Video Entry Queue:**

1. Expand the *MCU* tree, right-click the *Meeting Rooms, Entry Queues and SIP Factories* icon and then click **New Entry Queue**.

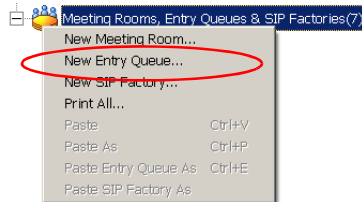

The *Entry Queue Properties* dialog box opens.

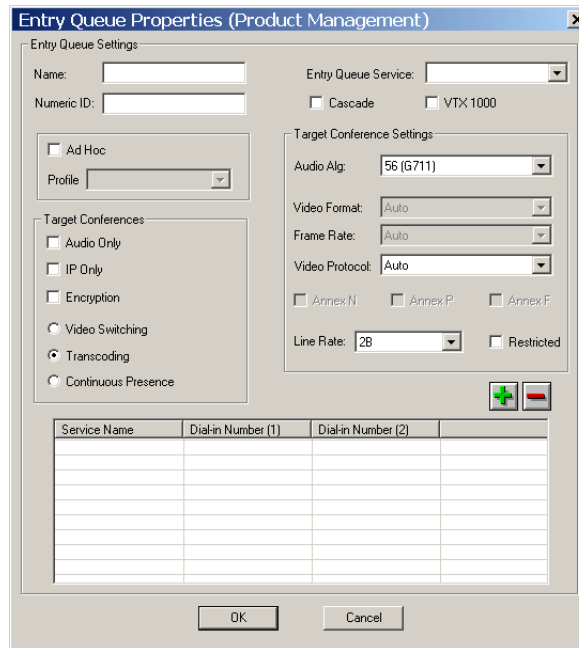

2. In the *Name* box assign a name to the Entry Queue using up to 20 characters.
3. To manually assign the *Numeric ID*, enter the required value in the *Numeric ID* box. To automatically assign the Numeric ID, complete the Entry Queue definition and save it to the MGC. The MCU automatically assigns the Numeric ID provided the MCU is configured to support automatic assignment of Numeric IDs.

4. In the *Entry Queue Service* box select a predefined Entry Queue Services that will be used to play voice messages and prompts to participants waiting in the Entry Queue. Leave this field blank to use a default Entry Queue Service, if one is defined.
5. In the *Target Conferences* area:
  - a. Select the **IP Only** check box to create an IP Only Entry Queue, whose target conferences are IP Only conferences and will enable the connection of IP participants only.
  - b. To create an encrypted Entry Queue, select the **Encryption** check box. For details about *Encryption* and encrypted Entry Queues, see *the MGC Manager User's Guide, Volume II, Chapter 1*.
  - c. Select **Video Switching, Transcoding** or **Continuous Presence** as the session type. For more information, see Chapter 4, "Video Conference Attributes" on page 4-3.



- Setting the Entry Queue to *Transcoding* or *Continuous Presence* requires Video resources, while a *Video Switching* Entry Queue does not.
- An *IP Only* Entry Queue set to *Continuous Presence* mode can only be defined as *Classic* and not as *Software* or *Quad Views*.

6. Select the *Line Rate* in which participants can connect to the conference. In Continuous Presence conferences, participants can connect using a lower line rate. If this Entry Queue will be used to access Conferences On Port, define the *Line Rate* as described in step 17 of "Creating an On Going Video Conference" on page 7-6.
7. Leave all the video and audio parameters set to **Auto** to let the system select the appropriate settings. For a detailed description, see *MGC Manager User's Guide, Volume II, Chapter 2*.
8. Define the dial-in numbers for the Entry Queue. For more details, see Chapter 6.
9. Click **OK**.

The new Entry Queue is added to the *Meeting Rooms, Entry Queues & SIP Factories* list.

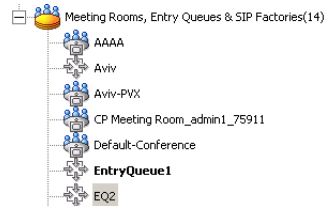

## Setting an Entry Queue as Default

A default Entry Queue can be defined for the MCU, regardless of the dialed IP card. The new default Entry Queue can be either a video Entry Queue or an Audio Only Entry Queue. Participants are automatically routed to the default Entry Queue when dialing one of the following strings:

- Network Service Prefix##Numeric ID when the numeric ID is incorrect
- Network Service Prefix##Numeric ID##Password when the numeric ID is incorrect
- Network Service Prefix only
- IP address of IP card##Numeric ID when the numeric ID is incorrect
- IP address of IP card##Numeric ID##Password when the numeric ID is incorrect
- IP address of the IP card only

### To set an Entry Queue as default:

- In the Meeting Rooms and Entry Queues list, right-click the Entry Queue and select **Set as Default**.

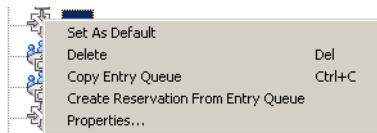

The default Entry Queue is identified by a bold name.

## Creating a Target Conference from an Entry Queue

You can create a new On Going conference or Reservation with the same parameters as the Entry Queue. This is especially useful for *Video Switching* conferences, since their parameters must be the same as those of the Entry Queue. The *Entry Queue Access* and *Meet Me Per Conference* options are automatically selected for this conference.

### To create a target conference from an Entry Queue:

1. Right-click the *Entry Queues* icon, and then click **Create Reservation from Entry Queue**.

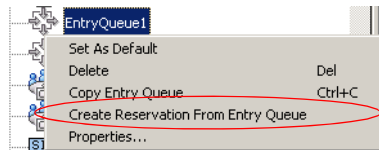

The *Conference Properties - General* dialog box opens. The parameters in the *General* and *Settings* tabs are automatically set to be compatible with this Entry Queue.

2. If required, modify parameters, making sure not to change the line rate or video settings. If these settings change, the Entry Queue and conference will not be compatible.
3. Click the **Scheduler** tab to define the conference start date and time. The current date and time are shown in the Scheduler dialog box. Do not change them if you want to start an On Going Conference.
4. Define the conference start date and time.
5. Click **OK**.

## Creating an On Going Video Conference

The following procedure describes the main parameters required to set up a Video Conference. For a detailed description of all parameters, see the *MGC Manager User's Guide, Volume I, Chapter 4*.

### To create an On Going Conference:

1. Expand the *MCU* tree, right-click the *On Going Conferences* icon and then click **New Conference**.

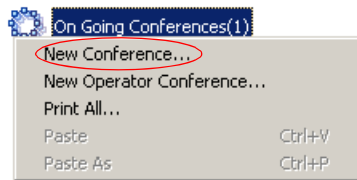

The *Conference Properties - General* dialog box opens.

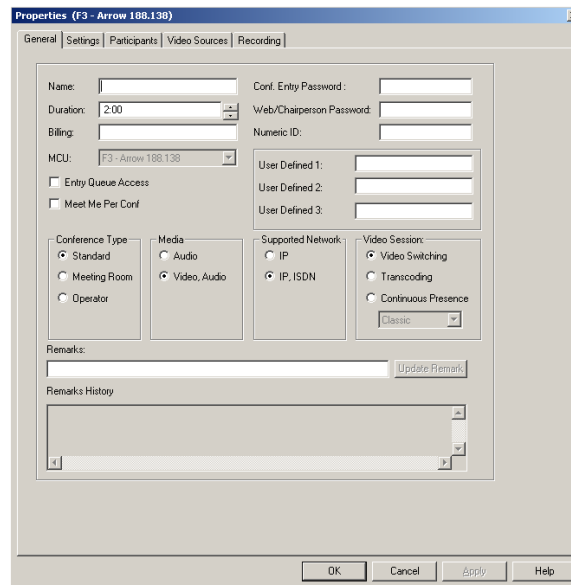

2. In the *Name* box, enter the conference name.
3. In the *Numeric ID* box, enter the desired conference Numeric ID.



4. In the *User Defined Fields* boxes, enter the requested information (if required).
5. Change the Conference's *Duration* if required.
6. In the *Supported Network* box, select the appropriate network types that will be used to connect participants to the conference. Select IP to allow only IP participants to the conference.
7. In the *Video Session* area, select **Video Switching**, **Transcoding** or **Continuous Presence**. For more information about these types of conferences, see "Video Conference Types" on page 4-3.
8. When selecting *Continuous Presence*, you can select **Classic** or **Quad Views** for the different layout options. If *IP* only is selected, the *Software* option is enabled in the *Video Session - Continuous Presence* box.
  - *Continuous Presence - Classic* offers 20 different video layouts, suitable for conferences of up to ten participants.
  - *Continuous Presence - Quad Views* offers 8 different video layouts, including layouts that are suitable for very large conferences.
  - *Continuous Presence - Software* allows Continuous Presence conferences to be set up with two types of Video Layout formats: 2x1 and 2x2.
9. To have participants access the conference through an Entry Queue, select the *Entry Queue Access* check box. If selected, the participant must dial the Entry Queue dial-in number and enter the correct conference Numeric ID in order to be transferred to this conference.
10. To allow undefined participants (who were not defined prior to the conference start) to connect directly to the conference without going through an Entry Queue, select the *Meet Me Per Conference* check box.



You can define the conference to be both *Entry Queue Access* and *Meet Me Per Conference*. In these conferences, a participant can connect to the conference directly, by means of the Meet Me Per Conference dial-in number, or through the Entry Queue, by means of the conference Numeric ID.

11. Optional. If an IVR service in which the conference password prompt enabled is assigned to the conference, enter the conference password (digits only) in the *Conf. Entry Password* box.

12. Optional. In the *Web/Chairperson Password* box, enter the chairperson password (if this option is enabled in the IVR Service assigned to the conference).
13. Click the **Settings** tab.  
The *Properties - Settings* dialog box opens.

The parameters described here are the *Basic* parameters. The *Advanced* parameters are usually not changed from their default values. For more information about these *Advanced* parameters, see the *MGC Manager User's Guide, Volume I, Chapter 4*.

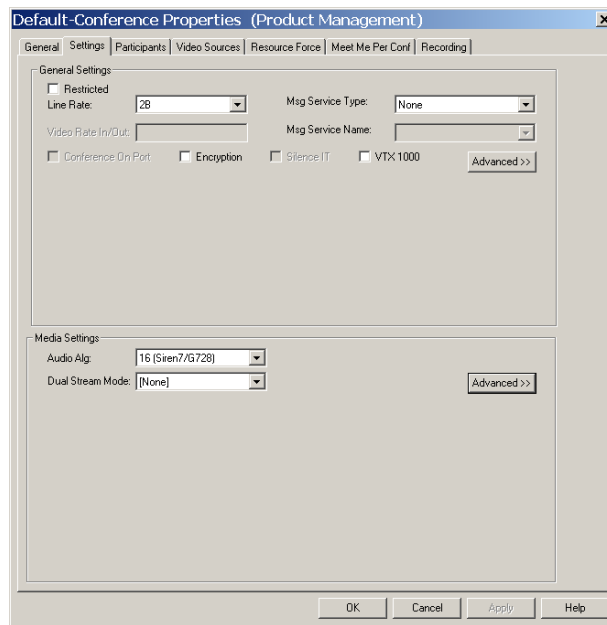

14. Select the **Restricted** option if all ISDN participants use restricted lines whose line rate for each channel is 56 Kbps instead of 64 Kbps.
15. In the *Line Rate* field, specify the transfer rate in Kbps:  
In a *Video Switching* conference, you must select the highest transfer rate *common* to all participants.  
In a *Transcoding* or *Continuous Presence* conference, select the desired maximum *Line Rate* for the conference. The system will attempt to

connect participants to the conference at this line rate or lower, according to their individual capabilities.

In a *Conference On Port (COP)*, select the estimated highest transfer rate common to all participants. In this mode, all conference participants must use the same video parameters.

In order to maintain a minimum video quality for a Conference On Port, there is a minimum threshold line rate that participants must support in order to connect with video. The minimum line rates necessary to connect to a Conference On Port are displayed in Figure 7-1. Participants attempting to connect at rates below the minimum conference line rate threshold are connected as Secondary (Audio Only).

Table 7-1: Conference On Port Line Rate Minimum Thresholds

Defined Conference Line Rate (in Kbps)	Minimum Participant Line Rate Necessary for Video Connection (in Kbps)
128	Participants will connect with video if video session can be established.
256	128
384	128
512	256
768	384
1920	768

16. In the *Msg Service Type* field, select **IVR** or **None** for a conference without voice messages. An IVR service allows participants to interact with the MCU by using DTMF codes and provides functionalities such as Conference Entry password, Conference Chairperson identification, Roll Call, Invite and Click&View. For more information about IVR, see the MGC Manager User's Guide, Volume II, Chapter 2.
17. If you have selected **IVR**, in the *Msg Service Name* list, select the name of the predefined IVR Service for the conference. If left blank, the default IVR Service is automatically selected if one is defined.
18. If required, select the **Conference On Port** option if available if *Continuous Presence* was selected in the *Video Session* area of the

*Conference Properties - General* tab. For more information about COP, see “Video Conference Types” on page 4-3.

19. To force all participants to use encryption, select the **Encryption** check box. For details about *Encryption* and encrypted conferences, see the *MGC Manager User's Guide, Volume II, Chapter 1*.
20. The Dual Stream mode and the Audio Algorithm are advanced features. For more information about these options, see the *MGC Manager User's Guide, Volume II, Chapter 1, “Dual Stream Modes”* and the *MGC Manager User's Guide, Volume I, Chapter 4 “Video Conference Parameters”*.
21. Optional. Click the **Participants** tab to add predefined participants to the conference. For more information on adding participants to a conference, see “To add a pre-defined participant to a conference:” on page 5-16.
22. If you selected *Continuous Presence* in the *Video Session* area of the *General* tab, click the **Video Sources** tab.

The *Conference Properties - Video Sources* tab opens.

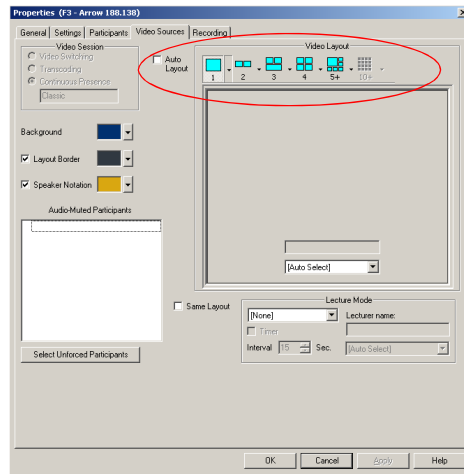

23. Select the appropriate *Video Layout* for the conference. The available layouts displayed are determined by the type of *Continuous Presence* mode selected on the *General* tab. For more information about setting Video Layouts, see the *MGC Manager User's Guide, Volume I, Chapter 6, “Setting Video Layouts”*.

Alternatively, select the *Auto Layout* check box to have the system automatically and dynamically apply layouts with the appropriate number of display windows according to the number of connected video participants.

24. In a Continuous Presence conference, you can add visual effects, such as borders and colors, to the video layouts display on the endpoints. For more details, see the *MGC Manager User's Guide, Volume I, Chapter 4*.



- The *Click&View* application available on participants' endpoints allows participants to modify their Personal Layouts, and the chairperson to modify the conference layout, in a Continuous Presence conference. For details about *Click&View*, see the *MGC Manager User's Guide, Volume I, Chapter 11*.
  - You must assign an IVR service to the conference to enable *Click&View*.
25. Use the default values for the remaining parameters. These parameters are detailed in the *MGC Manager User's Guide, Volume I, Chapter 4*.
  26. Click **OK**.  
The conference starts.

## Defining a New Video Meeting Room

A Meeting Room is a conference reservation without resource allocation, whose default duration is set to 2 hours.

### To define a New Video Meeting Room:

1. Expand the *MCU* tree.
2. Right-click the *Meeting Rooms, Entry Queues & SIP Factories* icon, and then click **New Meeting Room**.

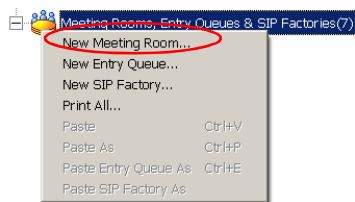

The *Conference Properties* dialog box opens.

3. Define the parameters in the *General, Settings, Participants* and *Video Sources* tabs as described in steps 2-26 in “Creating an On Going Video Conference” on page 7-6.

The Video Meeting Room is added to the *Meeting Rooms, Entry Queues & SIP Factories* list.

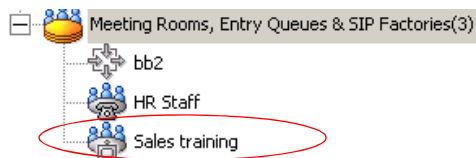

---

# Management Tools

Various management tools are available to the MGC+50/+100. For details on other management tools, see the *MGC Administrator's Guide*.

## Resource Report

The Resource Report displays the number of ports that can be allocated to participants and the number of ports that are currently assigned to On Going Conferences, soon-to-begin reservations and Meeting Rooms.

**To view the MCU resources:**

- Right-click the *MCU* icon, and then click **Resource Report**.

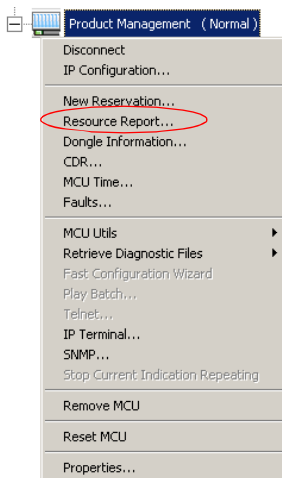

The *Resource Report* dialog box opens.

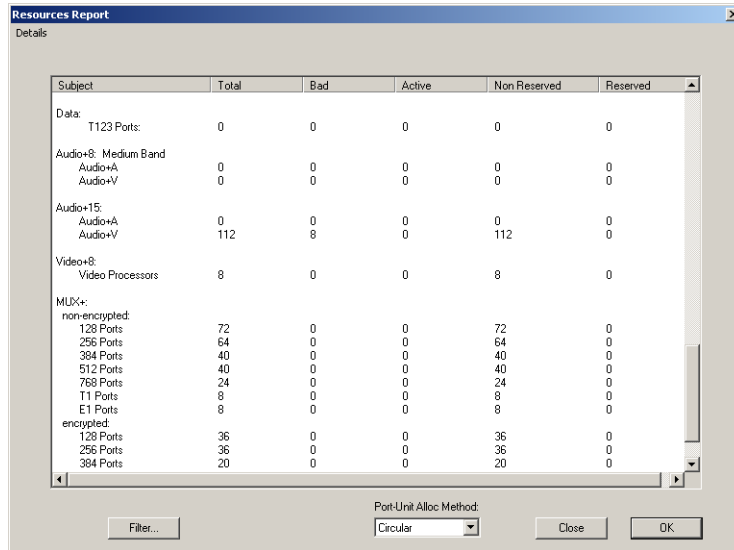

The Resource Report window contains the following columns:

Table 8-1: Resource Report Columns

Column Title	Description
<i>Subject</i>	Type of MCU resource. Includes the <i>Network Resources</i> that are used by participants to connect to the system, and <i>Media Resources</i> that are used by the system to run different types of conferences.
<i>Total</i>	Total number of resources of the same type installed on the system.
<i>Bad</i>	The number of disabled or faulty resources of each type.
<i>Active</i>	The number of ports currently used to run conferences for each resource type.
<i>Non Reserved</i>	The number of ports that are not reserved to be used within the next 5 minutes for each resource type.



Table 8-1: Resource Report Columns

Column Title	Description
<i>Reserved</i>	For each resource type, the number of active ports plus the number of ports for conferences that have reserved resources but disconnected participants, and reserved conferences to be run in the next 5 minutes.

## Resources Report - Network Resources

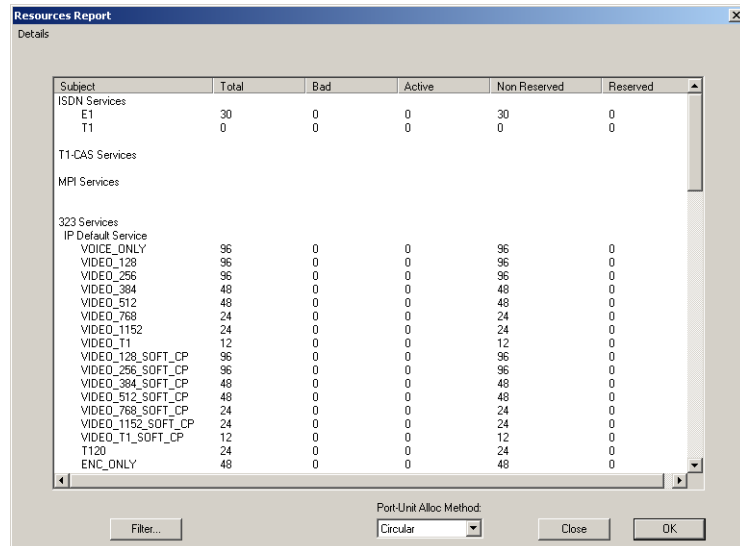

The screenshot shows a window titled "Resources Report" with a "Details" tab. It contains a table with the following data:

Subject	Total	Bad	Active	Non Reserved	Reserved
<b>ISDN Services</b>					
E1	30	0	0	30	0
T1	0	0	0	0	0
<b>T1-CAS Services</b>					
<b>MPI Services</b>					
<b>323 Services</b>					
<b>IP Default Service</b>					
VOICE_ONLY	96	0	0	96	0
VIDEO_128	96	0	0	96	0
VIDEO_256	96	0	0	96	0
VIDEO_384	48	0	0	48	0
VIDEO_512	48	0	0	48	0
VIDEO_768	24	0	0	24	0
VIDEO_1152	24	0	0	24	0
VIDEO_T1	12	0	0	12	0
VIDEO_128_SOFT_CP	96	0	0	96	0
VIDEO_256_SOFT_CP	96	0	0	96	0
VIDEO_384_SOFT_CP	48	0	0	48	0
VIDEO_512_SOFT_CP	48	0	0	48	0
VIDEO_768_SOFT_CP	24	0	0	24	0
VIDEO_1152_SOFT_CP	24	0	0	24	0
VIDEO_T1_SOFT_CP	12	0	0	12	0
T120	24	0	0	24	0
ENC_ONLY	48	0	0	48	0

At the bottom of the window, there is a "Port-Unit Alloc Method:" dropdown menu set to "Circular", and buttons for "Filter...", "Close", and "OK".

The *Network Resources* describes the bandwidth and port availability for participants connecting over various types of networks. This information includes **network resources only**. In order for participants to connect to a conference, they may also require Audio+, Video+, Data or MUX+ resources, depending on the type of participant and the type of conference.

In the example shown here, the MCU contains one Network Interface module connected to a E1 span, totaling 30 channels (1 x 30 channels).

### Resource Report - Network Resources Details

- **ISDN Services** - ISDN Network Services. This section describes the available bandwidth, in B channels, for each type of ISDN connection. Only the installed types of connections are displayed:
  - **E1** - Number of channels on E1 ISDN interfaces
  - **T1** - Number of channels on T1 ISDN interfaces
- **H.323 (IP) Services** - IP resources per participant type. This section describes the available ports for each possible type of IP (H.323 and SIP) participant. The available number of ports in any particular row represents the **total bandwidth and resources available for all types of participants**, so if one type of participant were to use some resources, the available resources for all other types of participants (rows) would be less. The Resources Report displays the total number of IP ports available according to the Conference Type, Line Rate, and Encryption in the format:

*Media\_Line Rate\_Conference Type. Media* may include *Voice, Video* or *Encrypted Video* ports. For example: VOICE\_ONLY, designating Audio Only participant resources; VIDEO-128-SOFT\_CP, designating video participants using a line rate of 128 Kbps in a Software Continuous Presence conference.

All IP participant types are listed in this manner, listing the available resources for IP participants in Standard Video and Audio Conferences, Software Continuous Presence, Encrypted Participants, Encrypted Participants in Software CP and Encrypted Participants in People Plus Content.

## Resources Report - Media Resources

Media Resources used by participants from different types of networks are displayed in the lower section of the *Resources Report* window. To view the *Media Resources* details, use the scroll bar on the right side of the window.

The screenshot shows a window titled "Resources Report" with a "Details" tab. It contains a table with the following data:

Subject	Total	Bad	Active	Non Reserved	Reserved
Data:					
T123 Ports:	0	0	0	0	0
Audio+8: Medium Band					
Audio+A	0	0	0	0	0
Audio+V	0	0	0	0	0
Audio+15:					
Audio+A	0	0	0	0	0
Audio+V	112	8	0	112	0
Video+8:					
Video Processors	8	0	0	8	0
MUX+:					
non-encrypted:					
128 Ports	72	0	0	72	0
256 Ports	64	0	0	64	0
384 Ports	40	0	0	40	0
512 Ports	40	0	0	40	0
768 Ports	24	0	0	24	0
T1 Ports	8	0	0	8	0
E1 Ports	8	0	0	8	0
encrypted:					
128 Ports	36	0	0	36	0
256 Ports	36	0	0	36	0
384 Ports	20	0	0	20	0

At the bottom of the window, there is a "Port-Unit Alloc. Method:" dropdown menu set to "Circular", and buttons for "Filter...", "Close", and "OK". A red circle highlights the vertical scroll bar on the right side of the table, with an arrow pointing to it and the text "Use the scroll bar to view the Media Resources Area".

### Media Resources Area Parameters Description

Each row item appearing in the *Media Resources Area* is described below.

- **Data** - Total number of T.120 resources for data conferencing.
  - **T.120 Ports** - Total number of ports available for participants using T.120. These resources are used by ISDN and MPI participants and can be used across multiple T.120 cards.
- **Audio+15** - The Audio+15 card can support 48 or 96 ports, depending on the audio algorithm used by the endpoint. Audio Only participants using Audio+ cards do not require MUX+ card resources and each Audio+ card is not limited in the number of conferences that it can run.
- **Video+8** - The Video+8 card contains 8 video processors and performs video processing for participants in Continuous Presence and Transcoding conferences. Conferences defined as *Continuous Presence*

-*Quad Mode* must run on the Video+8 card. Participants from multiple Video+8 cards can take part in a single conference.

- **Video Processors** - Total number of video processors from all Video+8 cards installed in the MCU. Each video processor can run a single Continuous Presence or Transcoding participant.
- **MUX+** - Displayed is the total number of MUX+ ports available according to the card type, line rate and encryption. A conference can be run on multiple MUX+ cards. Encrypted participants always require MUX+ resources and use more resources than a regular participant. IP Video participants do not require the MUX+ card, as all IP cards have built-in MUX+ functionality.

## Port-Unit Allocation Area

The screenshot shows a window titled "Resources Report" with a "Details" tab. It contains a table with the following data:

Subject	Total	Bad	Active	Non Reserved	Reserved
Data:					
T123 Ports:	0	0	0	0	0
Audio+8: Medium Band					
Audio+A	0	0	0	0	0
Audio+V	0	0	0	0	0
Audio+15:					
Audio+A	0	0	0	0	0
Audio+V	112	8	0	112	0
Video+8:					
Video Processors	8	0	0	8	0
MUX+:					
non-encrypted:					
128 Ports	72	0	0	72	0
256 Ports	64	0	0	64	0
384 Ports	40	0	0	40	0
512 Ports	40	0	0	40	0
768 Ports	24	0	0	24	0
T1 Ports	8	0	0	8	0
E1 Ports	8	0	0	8	0
encrypted:					
128 Ports	36	0	0	36	0
256 Ports	36	0	0	36	0
384 Ports	20	0	0	20	0

At the bottom of the window, there is a "Port-Unit Alloc Method:" dropdown menu with "Circular" selected. Other buttons include "Filter...", "Close", and "OK".

The *Port-Unit Allocation Method* box determines how all the resources are allocated. The selection of the mode can be done only when no conference is running.

The following modes are available:

- ***Circular*** - The system allocates the next available sequential unit in the order in which it is numbered on the card according to the unit numbers. For example, if the last used unit is 2, the next time a conference is run, the system will allocate units starting with unit 3 (provided that unit 3 is free). This mode should be used when you suspect that there may be faulty units, allowing the system to allocate other units for the conferences while the faulty units are replaced, or reset. However, this mode should not be used when debugging the system, as the problems will be inconsistent if the problematic units are not used constantly.
- ***Terminal*** - The system always starts the unit allocation from the first free unit on the first card. This mode may be problematic when there is one faulty unit (especially if it is the first or second) that prevents the system from running conferences. However, this should be the selected mode when debugging the system.

## Listing the Installed Cards

You can check which functional modules are installed in a particular MCU by listing them.

### To list an MCU's functional modules:

1. In the *Browser* pane, expand the *MCU* tree.
2. Expand the *MCU Configuration* tree.
3. Expand the *Cards* tree.

All the MCU slots are listed (16 slots for the MGC+100, 8 slots for the MGC+50). Empty slots are indicated by a grey card icon. Occupied slots are indicated by a green card icon. The name of the card occupying the slot appears next to the slot number.

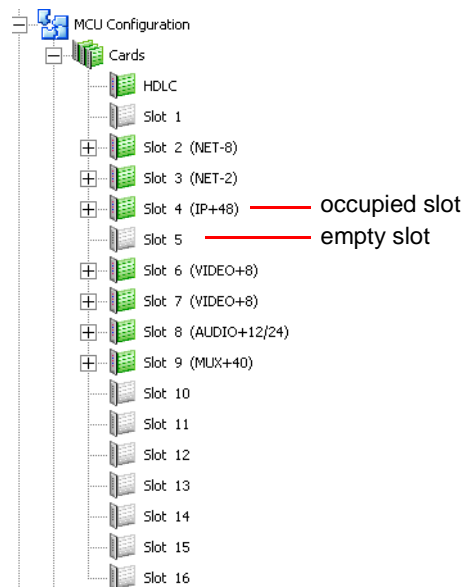

When the *Cards* icon in the *Browser* pane is double-clicked, the *Status* pane displays the status of the card.

Slot	Type	Clock	Configured Clock	Status	Occupied U...	Faulty Units	Disabled U...	Num Units
A	HDLCL			Normal	None	None	None	0 Units
1								
2	NET-8	Primary (#1)		Normal	None	2-8	None	8 Units
3	NET-2			Normal	None	1-2	None	2 Units
4	IP+48			Normal	None	None	None	3 Units
5								
6	VIDEO+8			Normal	None	None	None	8 Units
7	VIDEO+8			Normal	None	None	None	8 Units
8	AUDIO+12/24			Normal	None	None	None	4 Units
9	MUX+40			Normal	None	None	None	4 Units
10								
11								
12								
13								
14								
15								
16								

Occupied slots appear in green while empty slots appear in grey. The slot number appears next to the slot icon. Table 4-2 describes the *Status* pane columns.

Table 8-2: MCU's Cards Status Columns

Field	Description
<i>Slot</i>	Displays the slot icon and number; a grey icon indicates an empty slot and a green icon indicates an occupied slot.
<i>Type</i>	Displays the type of card that occupies the slot. The following card types are available, as listed in Table 4-1: <ul style="list-style-type: none"> <li>• Network (Net-2, Net-4, Net-8, MPI-4, MPI-8), IP+12, IP+24, IP+48</li> <li>• MUX+</li> <li>• Data</li> <li>• Audio+</li> <li>• Video+</li> </ul>

Table 8-2: MCU's Cards Status Columns

Field	Description
<i>Clock</i>	This column is valid only for ISDN and Serial (MPI-8) Network Interface cards. On the Net-2/Net-4/Net-8 Network Interface Module, the Master and the Backup clocks can be set on any of the spans connected to the module. This column indicates which Network card/span is used as the Master Clock and which one is used as the Backup clock.
<i>Configured Clock</i>	Indicates which ISDN Network card or MPI Span was configured as the Primary network interface (for clocking), and which one is used as backup. Changes take effect and are updated during the next MCU reset or power up.
<i>Status</i>	Indicates the card status; <i>Normal</i> or <i>Faulty</i> .
<i>Occupied Units</i>	Indicates the units on the card that are currently used to run conferences. For example, 1, 6 indicates that two units, unit # 1 and unit # 6 are used to run conferences.
<i>Faulty Units</i>	Indicates if there are units on the card which are faulty and the sequential number of the faulty unit.
<i>Disabled Units</i>	Indicates the units that were disabled by the operator.
<i>Num Units</i>	Indicates the total number of units available for each module.

For more information about viewing card parameters, see *MGC Manager Administrator's Guide*, Chapter 4.



## MCU Faults Report

The *Faults* function records faults related to the MCU that are encountered during operation.

### To view the Faults list:

1. Right-click the *MCU* icon, and then click **Faults**.

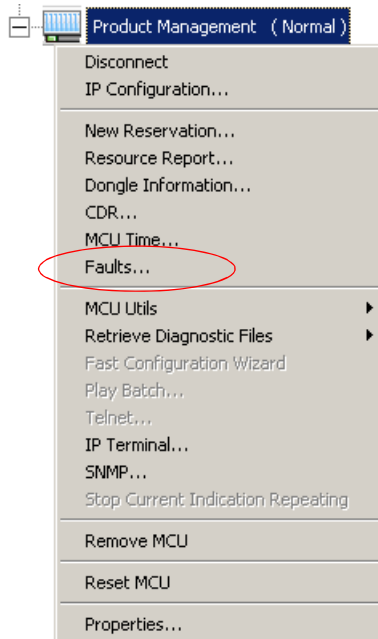

The *Faults* window opens.

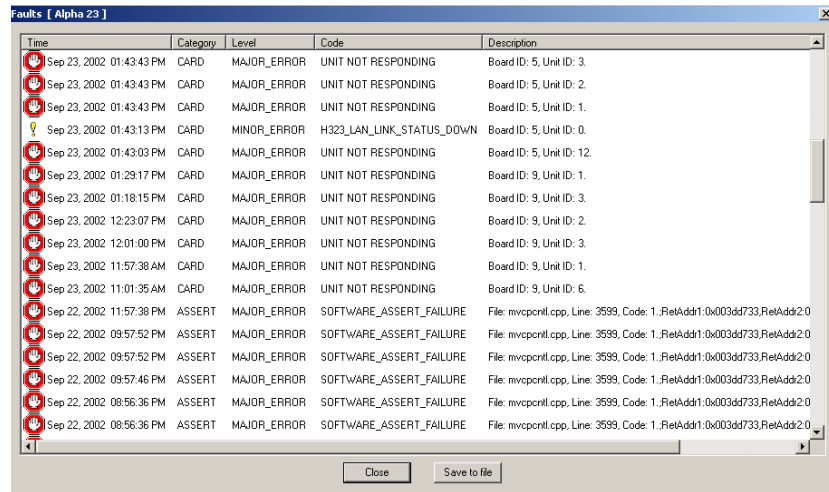





The following columns appear in the *Faults* report:

Table 8-3: *Faults* Fields

Field	Description
<i>Time</i>	Lists the date and time that the fault occurred. This column also includes the icon indicating the fault Level. The Levels and their icons are detailed in the Level field.
<i>Category</i>	Lists the type of fault. The following categories may be listed: <ul style="list-style-type: none"> <li><i>File</i> - the fault is caused when a problem is detected in one of the files stored on the MCU's hard disk.</li> <li><i>Reservation</i> - indicates that conferences that were reserved in the system when the system was shut down were not recovered when the system restarted.</li> <li><i>Card</i> - indicates problems with a card.</li> <li><i>Exception</i> - indicates errors reported by the computer (PC).</li> </ul>

Table 8-3: Faults Fields

Field	Description
<i>Category (cont.)</i>	<ul style="list-style-type: none"> <li>• <i>General</i> - indicates general faults.</li> <li>• <i>Assert</i> - indicates internal software errors that are reported by the software program.</li> <li>• <i>Startup</i> - indicates errors that occurred during system startup.</li> </ul>
<i>Level</i>	<p>Indicates the severity of the problem. The following fault indicators are available:</p> <ul style="list-style-type: none"> <li>• Major Error </li> <li>• Minor Error </li> <li>• MCU Startup indicator </li> <li>• System Message </li> </ul> <p>The icon of the fault <i>Level</i> appears in the <i>Time</i> column.</p>
<i>Code</i>	Indicates the code of the problem, according to the fault category. A list of codes per category can be found in Appendix A of the MGC Administrator's Guide.
<i>Description</i>	When applicable, displays a more detailed explanation of the cause of the problem.

2. You may save the Faults report to a text file. To do so, click the **Save to file** button.

The *Save As* dialog box opens.

3. Select a destination folder and enter the file name, and then click **Save**.

You are returned to the *Faults* window.

4. To exit the *Faults* window without saving the data to file, click the **Cancel** button.

## Reset MCU

The *Reset MCU* function is used to reset the MCU when there are substantial changes to the MCU hardware, or when there are problems with the MCU. If a reset is performed while running On Going Conferences, at the end of the MCU Startup, these conferences are automatically restored with all the participants in “Standby” state, and will be reconnected to the conference.

When the MCU is started, only the list of near future reservations is loaded to the MCU memory, while the information of all other reservations are kept on the MCU’s hard disks, resulting in faster loading time.

### To reset the MCU:

- Right-click the *MCU* icon, and then click **Reset MCU**.

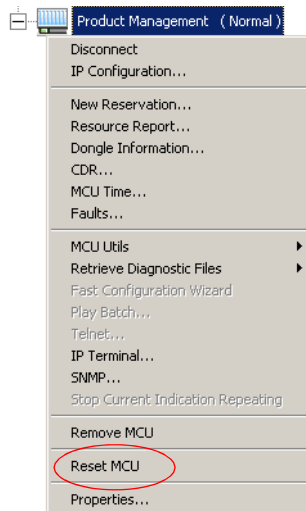

When the MCU is restarts, the MCU icon changes accordingly.

## Obtaining Additional Information

Information about Polycom products, technologies, and network solutions is available from the company Web site, at the following URL:

[http://www.polycom.com/home/resource\\_center/](http://www.polycom.com/home/resource_center/)

## Free Manuals Download Website

<http://myh66.com>

<http://usermanuals.us>

<http://www.somanuals.com>

<http://www.4manuals.cc>

<http://www.manual-lib.com>

<http://www.404manual.com>

<http://www.luxmanual.com>

<http://aubethermostatmanual.com>

Golf course search by state

<http://golfingnear.com>

Email search by domain

<http://emailbydomain.com>

Auto manuals search

<http://auto.somanuals.com>

TV manuals search

<http://tv.somanuals.com>