



▶ Polycom® RMX® 1500 Hardware Guide

Version 7.0 | August 2010 | DOC2557A

Trademark Information

Polycom®, the Polycom “Triangles” logo, and the names and marks associated with Polycom’s products are trademarks and/or service marks of Polycom, Inc., and are registered and/or common-law marks in the United States and various other countries.

All other trademarks are the property of their respective owners.

Patent Information

The accompanying product is protected by one or more U.S. and foreign patents and/or pending patent applications held by Polycom, Inc.

© 2010 Polycom, Inc. All rights reserved.

Polycom, Inc.
4750 Willow Road
Pleasanton, CA 94588-2708
USA

No part of this document may be reproduced or transmitted in any form or by any means, electronic or mechanical, for any purpose, without the express written permission of Polycom, Inc. Under the law, reproducing includes translating into another language or format.

As between the parties, Polycom, Inc., retains title to and ownership of all proprietary rights with respect to the software contained within its products. The software is protected by United States copyright laws and international treaty provision. Therefore, you must treat the software like any other copyrighted material (e.g., a book or sound recording).

Every effort has been made to ensure that the information in this manual is accurate. Polycom, Inc., is not responsible for printing or clerical errors. Information in this document is subject to change without notice.

Table of Contents

Hardware Description	1-1
Main Features	1-1
RMX 1500 Specifications	1-2
RMX 1500 System Capacities	1-3
Site Requirements	1-5
Safety Requirements	1-5
Rack Mount Safety Precautions	1-5
Installation Precautions	1-6
Connecting the RMX 1500 to a Power Source	1-7
Connecting the RMX 1500 to AC Power	1-7
Connecting Cables on the RMX 1500	1-8
First-time Power-up	1-8
RMX 1500 Components	1-10
RMX 1500 Front Panel	1-10
Opening the RMX 1500 Front Panel	1-10
Front Panel Components	1-11
RMX 1500 Rear Panel	1-12
RTM IP 1500	1-12
RTM ISDN 1500	1-14
ISDN/PSTN Clock Source	1-15
RMX 1500 Power Supply	1-15
Power Supply LEDs	1-15
RMX 1500 LEDs	1-16
RMX 1500 Front Panel LEDs	1-16
RMX 1500 Rear Panel LEDs	1-17
RTM IP 1500 LEDs	1-17
RTM ISDN 1500 LEDs	1-19
Power Supply LEDs	1-19
Component Installation & Replacement	2-1
Installing the RTM ISDN 1500 Card	2-2
Component Replacement	2-4
Replacing the RTM ISDN 1500	2-5

Hardware Description

This Hardware Guide provides information on the RMX 1500 and its components. This system utilizes a modular platform, whose components are designed for high performance, capacity and reliance.

Main Features

The Polycom RMX 1500 offers the following features:

- Linux® based
- Chassis based on the ATCA standard
- Support for standard network interfaces (H.323, SIP video, ISDN, PSTN and LAN)
- New hardware technologies
- Telco grade high availability, on-line upgrading and dynamic resource allocation
- Easy integration of conference elements into external network management
- Enhanced Continuous Presence (multi-image video)
- IVR (Interactive Voice Response) module

RMX 1500 Specifications

Table 1-1 Polycom RMX 1500 Specifications

Physical	
Height	1U (4.44 cm.)
Width	19" (48.26 cm.)
Depth	23.6" (60 cm.)
Weight	Up to 12 Kg.
Media Protocols	
Audio	G.711, G. 719, G.722, G.722.1, G.729A, G.723.1, Siren14, Siren 22.
Video	H.261, H.263, H.264.
Network Interfaces	
IP, ISDN, PSTN and LAN	H.323, SIP, ISDN, PSTN and LAN
Power Supply	
AC Input/ Range, BTU	Voltage range: 100-240 VAC \pm 10%, 47-63 Hz. Maximum BTU output: 3400 per hour.
Power Consumption	
AC Maximum Power consumption	350 Watts.
Environment	
Operating temperature	0°– 40°C (22°– 104°F).
Storage temperature	-40°– 70°C (-40°– 158°F).
Relative humidity	15% - 90% no condensing.
Operating altitude	Up to 4,500 m (15,000 ft.).
Operating ESD	4 kV.

RMX 1500 System Capacities

The following table summarizes the different system capacities.

Table 1-2 System Functions and Capacities RMX 1500

System Functions	Capacity
<i>Maximum number of Video participants in a conference</i>	90
<i>Maximum number of PSTN participants in a conference</i>	120
<i>Maximum number of VOIP participants in a conference</i>	360
<i>Maximum number of Audio calls per second</i>	5
<i>Maximum number of Video calls per second</i>	2
<i>Maximum number of Conferences</i>	400
<i>Maximum number of Meeting Rooms</i>	1000
<i>Maximum number of Entry Queues</i>	40
<i>Maximum number of Profiles</i>	40
<i>Maximum number of Conference Templates</i>	100
<i>Maximum number of SIP Factories</i>	40
<i>Maximum number of IP Services</i>	1
<i>Maximum number of ISDN Services</i>	2
<i>Maximum number of IVR Services</i>	40
<i>Maximum number of Recording Links</i>	20 (default)
<i>Maximum number of IVR Video Slides</i>	150
<i>Maximum number of Log Files (1Mb max.)</i>	4000
<i>Maximum number of CDR Files</i>	2000
<i>Maximum number of Fault Files</i>	1000
<i>Number of Participant alerts</i>	Unlimited
<i>Maximum number of concurrent RMX Web Client connections to the MCU</i>	20

Table 1-2 System Functions and Capacities RMX 1500

System Functions	Capacity
<i>Maximum number of Users</i>	100
<i>Maximum number Address Book entries</i>	4000
<i>Maximum number of gateway profiles</i>	40
<i>Maximum number of Reservations (Internal Scheduler)</i>	2000

Table 1-3 System Resource Capacities According to Video Resolution

Video Resolution	Resources with MPMx
<i>HD Support</i>	CP / VSW
<i>PSTN</i>	120
<i>VOIP</i>	360
<i>ISDN</i>	60 (128 Kbps) - 4 E1/T1
<i>CIF H.263</i>	60
<i>CIF H.264</i>	90
<i>SD</i>	60
<i>4CIF</i>	30
<i>720p30</i>	30
<i>1080p30fps/720p60</i>	15 (Symmetric)
<i>720p VSW 2Mb</i>	80
<i>1080p VSW 2Mb</i>	80
<i>720 VSW 4Mb</i>	60
<i>1080p VSW 4Mb</i>	40
<i>1080p VSW 6Mb</i>	20

Site Requirements

This section describes the requirements your site must meet for safe installation and operation of the system.

Safety Requirements

For your protection, please read these safety instructions completely before operating the equipment.

- Look carefully for potential hazards in your work area: moist floors, ungrounded power cables, frayed power cords, missing safety grounds and so forth.
- Locate the main circuit breaker within the room.
- Locate the emergency power **OFF** switch within the room.
- Never assume that power is disconnected from a circuit.
- Use only the power cord supplied with the system.
- The power cord should only be connected to a power outlet that has a protective ground contact.
- Ensure that the power cord is easily accessible from the back of the system at all times.
- Place the equipment in a well-ventilated area where the vents are free from obstruction.
- Do not place heavy objects directly on top of the RMX 1500 unit.
- Do not use liquids around your equipment.

Rack Mount Safety Precautions

The following precautions should be followed with regards to rack mount safety:

- Keep the area around the RMX 1500 clean and free of clutter.
- Decide on a suitable location for the equipment rack that will hold the RMX 1500 unit. It should be situated in a clean, dust-free area that is well ventilated. Avoid areas where heat, electrical noise and electromagnetic fields are generated. You will also need it placed near a grounded power outlet.
- Ensure that the leveling jacks on the bottom of the rack are fully extended to the floor with the full weight of the rack resting on them.

- In a single rack installation, stabilizers should be attached to the rack.
- In multiple rack installations, the racks should be coupled together.
- Always make sure the rack is stable before extending a component from the rack.
- You should extend only one component at a time - extending two or more simultaneously may cause the rack to become unstable.
- Before you install the rails, determine the placement of each component in the rack.
- Install the heaviest components on the bottom of the rack first, and then work up.
- Allow the power supply units to cool before touching them.
- Always keep the rack's trays and card's slots closed when not servicing, to maintain proper cooling.

Installation Precautions



When handling electronic components, standard anti-static precautions must be observed:

- Wear a grounding strap
- Handle cards by their edges only and do not touch their components or connector pins
- Keep components in anti-static bags, when not installed in the RMX1500

The following precautions should be followed with regards to installation of the RMX 1500:

- Use a regulating uninterruptable power supply (UPS) to protect the RMX 1500 from power surges and voltage spikes, to keep your MCU operating in case of a power failure.
- Place the RMX 1500 on a hard, flat surface such as a desktop or mount it on 19" rack.
- The airflow of the RMX 1500 is from right to left. Be sure that the areas in the left and right side of the system are clear for proper ventilation.

Connecting the RMX 1500 to a Power Source

The following restrictions apply to the conductors and connectors that may be used to ground the unit when rack mounted:

- When using bare conductors, they must be coated with an appropriate antioxidant compound before crimp connections are made. Tinned, solder-plated or silver-plated connectors do not have to be prepared in this manner.
- The same bolt assemblies should not secure multiple connectors.
- Listed fastening hardware must be compatible with the materials being joined and must preclude loosening, deterioration and electrochemical corrosion of the hardware and joint materials.

Connecting the RMX 1500 to AC Power



- Do not connect the green or green-yellow wire to the system single-point ground screw.
- Only the AC Power cable supplied by Polycom should be used.
- The size of the protective earthing conductor should be a minimum of 10AWG.
- The outlet intended for connecting the power cord must be protected with an external overcurrent protection device either in building or in the rack with the rating not higher than 20Amp.
- Do not use an Extension cord with the cable.

- 1 Make sure that the power button is switched OFF on the RMX 1500.

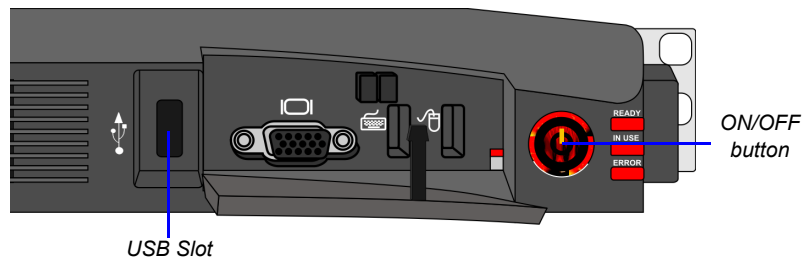

- 2 Insert the power cable into the power connector on the rear panel of the RMX 1500.

Connecting Cables on the RMX 1500

To connect the cables:

- For the **RTM-IP 1500 module**:
 - Connect the Media cable to **LAN 2** port.
 - Connect the Network cables to the **MNG (Signaling)** port & **MNGB (Management Network)** port.
 - (Optional) Connect the *Shelf Management* cable to the **Shelf** port.
- For the **RTM ISDN 1500 module**:
 - Connect the E1/T1 cables to their **PRI (1-4)** ports.

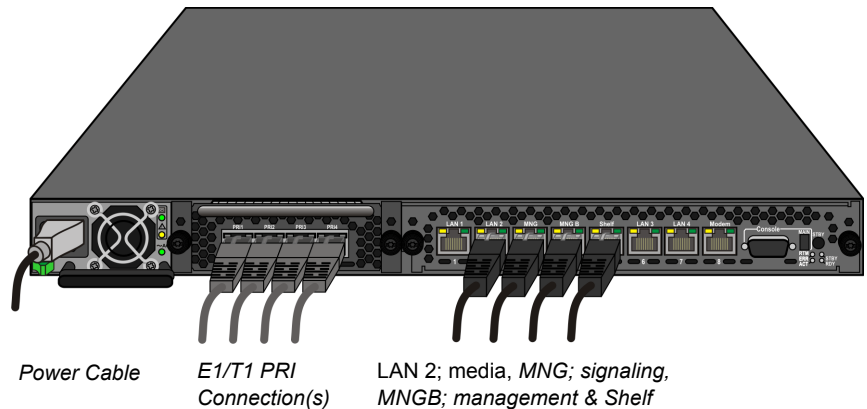

Figure 1-1 RMX 1500 Rear Panel View with AC Power and Communication Cables



The LAN 1, LAN3, LAN4 and Modem ports are not be used and the plastic caps covering those ports should not be removed.

First-time Power-up

- 1** For first entry installation, you must insert the *USB key* containing the modified IP addresses in *USB slot* on the RMX's front panel. For more information see, the RMX 1500/2000/4000 Getting Started Guide, "Procedure 1: First-time Power-up" on page **2-19**.
- 2** Turn ON the power by pressing on the power switch located on the front panel of the RMX 1500.

The parameters in the lan.cfg file are uploaded from the USB key to the RMX's memory and applied during the power-up sequence.

System power-up sequence may take up to five minutes.

During the First-time Power-up the red ERROR LED on the RMX's front panel remains ON until both the *Management* and *IP Network Services* have been defined.

When the RMX's configuration is completed (including the *Management* and *IP Network Services*), and if there are no *System Errors*, the green READY LED (on the RMX's front panel) turns ON.

- 3** Remove the *USB key*. For more information see, the RMX 1500/2000/4000 Getting Started Guide, "*Hardware Description*", "*Procedure 4: Modifying the Default IP Service and ISDN/PSTN Network Service Settings*" on page [2-22](#)

RMX 1500 Components

On the RMX 1500, components are located on both the front and rear of the MCU as listed in Table 1-4, "*Polycom RMX 1500 Front Panel Description*". For more information see the descriptions of the "*RMX 1500 Front Panel*" on page 1-10 and "*RMX 1500 Rear Panel*" on page 1-12.

RMX 1500 Front Panel

The front panel enables access to the RMX 1500 using a USB key, keyboard, mouse and VGA connection.

Opening the RMX 1500 Front Panel

The RMX 1500 has a front panel which can be opened by pressing on the location shown in the following illustration:

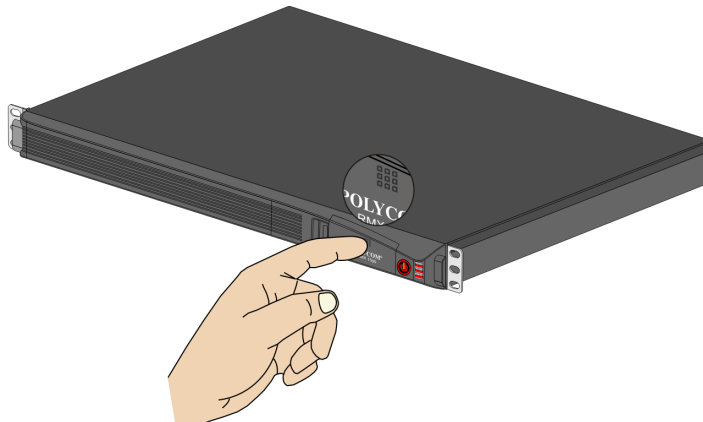

Front Panel Components

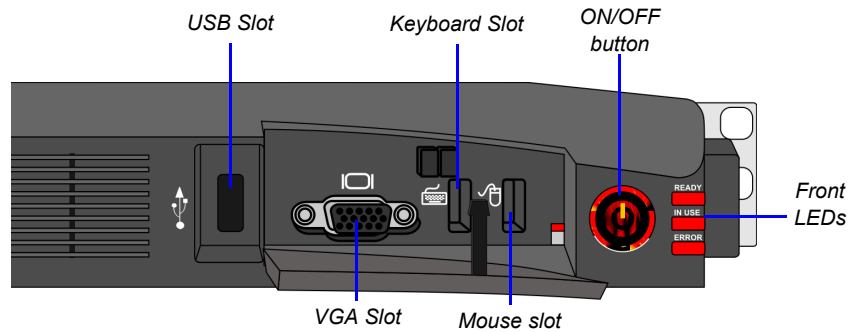

Figure 1-2 RMX 1500 Front Panel

Table 1-4 Polycom RMX 1500 Front Panel Description

SLOT/Button/LED	Description
USB Slot	USB key connection, used for First time configuration.
VGA Slot	Monitor connection.
Keyboard Slot	Keyboard connection.
Mouse Slot	Mouse connection.
ON/OFF Button	Turn the RMX ON or OFF.
READY Led	Orange - RMX Starting up. Green - RMX ready/online.
IN USE Led	Amber - In use, when a conference is active.
ERROR Led	Red - Error.

RMX 1500 Rear Panel

The RMX 1500 rear panel contains the RTM IP 1500 and optionally, the RTM ISDN 1500. In addition, the rear panel houses the power supply with fan & AC inlet, and Serial port.

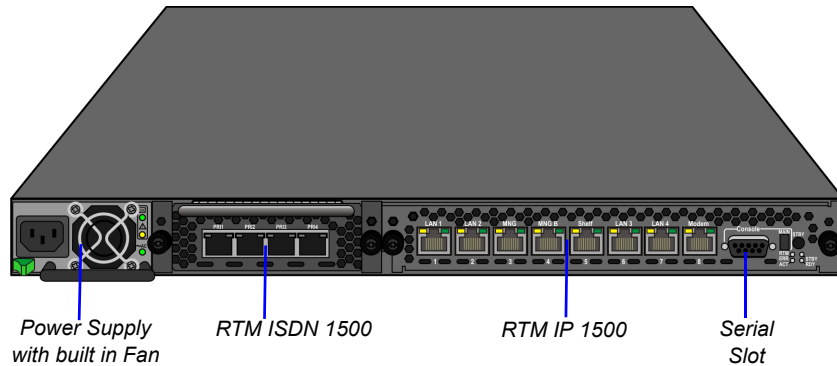

RTM IP 1500

This card contains an Ethernet Switch that manages the network of the system, routes data between the cards and components of the system and provides connectivity to external IP networks. It controls and monitors the system fans and regulates power supply.

The RTM IP 1500 connections include:

- 2 signalling & media ports
- 2 ethernet management ports
- Shelf (Manager) port
- Modem
- 1 Serial port



The LAN 1, LAN3, LAN4 and Modem ports are not be used and the plastic caps covering those ports should not be removed.

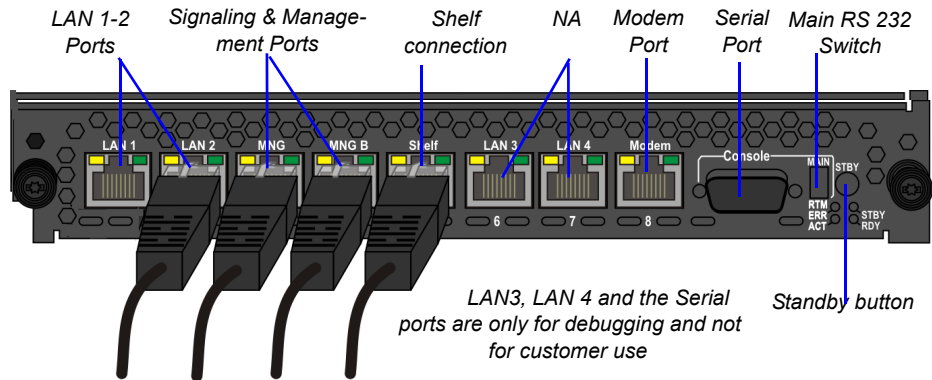

Figure 1-3 RMX 1500 RTM IP Rear Panel Layout

The following items appear on the RMX 1500 rear panel:

Table 1-5 RMX 1500 Rear Panel - RTM IP 1500 Component Description

Item	Description
LAN 1 port	Not Available (NA).
LAN 2 port	LAN (Media) Connection. 1 Media IP address is available.
MNG port	Signaling connection.
MNG B	Management connection for Web Client and RMX Manager.
LAN 3/4 ports	Not Available (NA). Note: LAN 3/4 are covered with a plastic cap that should not be removed.
Shelf (Manager) port	(Optional) Shelf Manager connection.
Modem port	Internal IP connection, for debugging purposes only.
Serial (RS 232) port	For debugging purposes only. Enables print-outs of various LOGs from RTM IP 1500 and Card Manager.
MAIN/RTM	Selection of the connection type for the RS-232 Port. When the switch is up - the serial port connects to the MPMx card. When the switch is down, connects to the RTM IP.

Table 1-5 RMX 1500 Rear Panel - RTM IP 1500 Component Description

Item	Description
Standby button	Toggle button. Use this button to either perform Diagnostics or Software Recovery on the RMX. Short press (2 seconds) - MPMx Diagnostics. Long press - (10 seconds) Media and RTM IP 1500 Software Recovery.

RTM ISDN 1500

The RTM ISDN 1500 connects directly to the built-in MPMx. The RTM ISDN card routes data between the MPMx card and components of the system, converts ISDN T1/E1 media to IP packets and provides connectivity to external ISDN networks.

The RTM ISDN card is installed on the rear panel of the RMX interfaces between the RMX unit and the ISDN/PSTN switch.



With the RMX 1500, you can either have a dedicated E1 or T1 Type Network Service. It is not possible to have a mixed E1 and T1 ISDN Network Service.

The RTM ISDN card contains four connections to which up to four E1 or T1 PRI lines can be connected as shown in Figure 1-4.

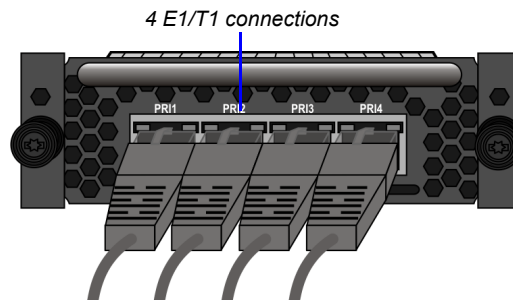
**Figure 1-4** RMX 1500 RTM ISDN Rear Panel Layout

The RTM ISDN card supports up to 200 audio participants, regardless of whether the spans are E1 or T1.

ISDN/PSTN Clock Source

Each RTM ISDN 1500 has its own primary and secondary clock source. The first span to synchronize becomes the primary clock source and the second span to synchronize becomes the secondary clock source. This clock is used to synchronize ISDN spans only (it is not the system clock). A single clock source triggers an alarm that can be turned off by setting the appropriate flag in the system configuration.

RMX 1500 Power Supply

Subject to availability on the RMX 1500 there are two types of power supplies (Power-One & Astec), both are identical in their functionality.

Power Supply LEDs

On the RMX 1500 there are three LEDs that indicate the power status.

Table 1-6 Polycom RMX 1500 Power Supply LEDs

Power Supply LED	Description
OK	DC power indication to internal components of the RMX: Green - DC Power Good.
 (Alarm symbol)	Power supply failure Indication: Amber - Power Supply Failure.
AC/~ (symbol)	Main power supply indication (Voltage In): Green - Voltage Input > 85 VAC.

RMX 1500 LEDs

The RMX includes LEDs located on the front panel and rear panel. In the front panel, the LEDs reflect the state of the components. The LEDs on the rear panel indicate the state of the external connections and the status of the RTM IP card.

RMX 1500 Front Panel LEDs

The following items appear on the RMX 1500 front panel:

Table 1-7 RMX 1500 Front Panel LED's

Component	LED ID	LED Color	Indication
Front Panel	ERROR	Red	ON - Major system error. In case of an active alarm this light is ON, and the READY-green is OFF.
			OFF - Normal.
			Flashes - During system startup.
	READY	Green	ON - CPU card has successfully completed startup. This light turns green after completing the entire system configuration.
			OFF - Turns OFF when the ERROR red LED is activated.
			Flashes - During system startup.
IN USE	Amber	ON - At least one endpoint is connected to the system. Flashes - During system startup.	

RMX 1500 Rear Panel LEDs

RTM IP 1500 LEDs

The following LEDs appear on the RTM IP 1500:

Table 1-8 RTM IP 1500 LEDs

Component	LED Name	LED Color	Indication
LAN LEDs (1-2)	LNK	Green	ON with an active network connection, flickers with Packet activity.
	1 Gb	Amber	ON with a 1Gb online connection, flickers with Packet activity.
MNG LED	LNK	Green	ON with an active network connection, flickers with Packet activity.
	1 Gb	Amber	ON with a 1Gb online connection, flickers with Packet activity.
MNG B LED	LNK	Green	ON with an active network connection, flickers with Packet activity.
	1 Gb	Amber	ON with a 1Gb online connection, flickers with Packet activity.
Shelf LED	LNK	Green	ON with an active network connection, flickers with Packet activity.
	100	Amber	ON when the active network is 10/100Mb, flickers with Packet activity.

Table 1-8 RTM IP 1500 LEDs (Continued)

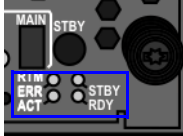
Component	LED Name	LED Color	Indication
Modem	LNK	Green	ON with an active network connection, flickers with activity.
		Amber	ON when the active network is 10/100Mb, flickers with activity.
Additional LEDs (4) 	ERR	Red	ON - Major error on RTM IP 1500. Flashes - During system startup.
	ACT	Red	ON - Packet flow to and from the MCU chassis. Flashes - During system startup.
	STBY	Green	ON - CPU & System are in a standby (OFF) mode.
	RDY	Green	ON - RTM IP 1500 has successfully completed startup. Flashes - During system startup.

RTM ISDN 1500 LEDs

The following LEDs appear on the RTM ISDN:

Table 1-9 RTM ISDN 1500 LEDs

Function Name	LED Name	LED Color	Indication
PRI (1-4) LEDs	LNK	Green	ON with an active network connection, flickers with Packet activity.
	1 Gb	Amber	ON when 1Gb connection is online, flickers with Packet activity.

Power Supply LEDs

The following items appear on the rear panel power supply:

Table 1-10 Power Supply LED's

Component	LED ID	LED Color	Indication
Power Statuses	OK	Green	OK.
	Alarm	Amber	PS Fail - Problem with power supply. This amber LED is driven by internal circuitry and will illuminate when a power rail has failed.
	AC	Green	When the power cable is plugged-in, the AC LED becomes lit.

Component Installation & Replacement

On the RMX 1500 you can install and replace the RTM ISDN 1500 card. For more information see, "*Installing the RTM ISDN 1500 Card*" on page [2-2](#).

Before installing a parts:

- Make sure you have the correct replacement part on hand.
- Make sure you are using proper ESD equipment, to prevent damage to the system.

**Warning!**

- All maintenance tasks are to be performed by qualified, authorized personnel.
- Use only replacement parts supplied by your dealer.
- Follow all procedures. Do not skip any steps.

Installing the RTM ISDN 1500 Card

Prior to adding the RTM ISDN 1500 card you must have your ISDN product license available. For more information see, *RMX 1500/2000/Getting Started Guide*, "Procedure 2: Product Registration" on page **2-20**.

- 1** Ensure that the power switch on the RMX 1500 is turned OFF (O).
- 2** Loosen the captive screws that fasten the card to the MCU.
- 3** Slide in the RTM ISDN 1500 card.

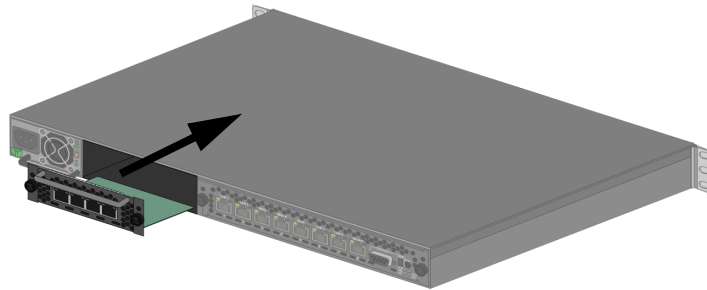

- 4** Insert the card into the slot and tighten the captive screws on each side of the rear panel of the card, securing the RTM ISDN card to RMX.



- 5 Connect the PRI cables.

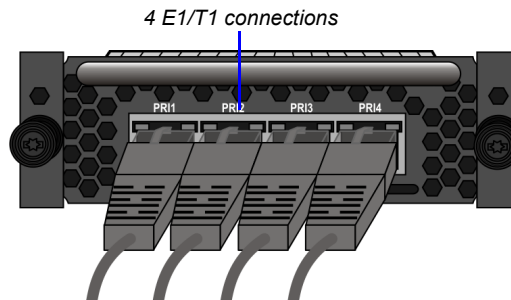

- 6 Turn ON the RMX 1500.
- 7 Login on to the RMX Web Client.
 - a Update your license. For more information see, *RMX 1500/2000/Getting Started Guide, Chapter 2, "Procedure 2: Product Registration"* on page [2-20](#).
 - b In the *ISDN/PSTN Network Services* define a **New ISDN Network Service**. For more information see, *RMX 1500/2000/4000 Administrator's Guide, Chapter 13, "Adding/Modifying ISDN/PSTN Network Services"* on page [13-51](#).

Component Replacement

The RMX 1500 is designed with ease of maintenance in mind. Most components are swappable and are accessible directly via the front panel or the rear panel.

The following component can be replaced when it is faulty:



The RTM-IP 1500 and Power Supply are not field replaceable.

- RTM ISDN 1500, see "*Replacing the RTM ISDN 1500*" on page [2-5](#).

Before replacing a part:

- Make sure you have the correct replacement part on hand.
- Make sure you are using proper ESD equipment, to prevent damage to the system.

Replacing the RTM ISDN 1500

- 1 Ensure that the power switch on the RMX 1500 is turned OFF (O).
- 2 Remove the PRI cables.
- 3 Loosen the captive screws that fasten the card to the MCU.



- 4 Remove the RTM ISDN card and pull the RTM ISDN card out of its slot in the backplane.
- 5 Carefully slide the RTM ISDN card out through the rear panel.

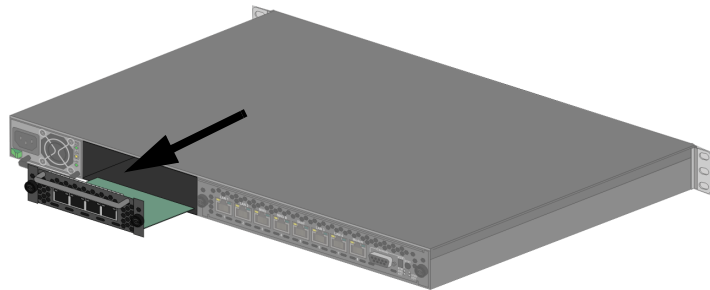

- 6 Slide in the replacement RTM ISDN card into its slot.
- 7 Tighten the captive screws on each side of the rear panel of the card, securing the RTM ISDN card to RMX.
- 8 Connect the PRI cables.
- 9 Turn ON the RMX 1500.

Free Manuals Download Website

<http://myh66.com>

<http://usermanuals.us>

<http://www.somanuals.com>

<http://www.4manuals.cc>

<http://www.manual-lib.com>

<http://www.404manual.com>

<http://www.luxmanual.com>

<http://aubethermostatmanual.com>

Golf course search by state

<http://golfingnear.com>

Email search by domain

<http://emailbydomain.com>

Auto manuals search

<http://auto.somanuals.com>

TV manuals search

<http://tv.somanuals.com>