

Polycom[®] KIRK Wireless Server 1500 Installation and Maintenance Guide

72-1604-00, Issue B



Copyright © Polycom, Inc.
All Rights Reserved

Catalog No: 72-1604-00, Issue B

Proprietary and Confidential

The information contained herein is the sole intellectual property of Polycom, Inc. No distribution, reproduction or unauthorized use of these materials is permitted without the expressed written consent of Polycom, Inc. Information contained herein is subject to change without notice and does not represent commitment of any type on the part of Polycom, Inc. Polycom and Accord are registered trademarks of Polycom, Inc.

Notice

While reasonable effort was made to ensure that the information in this document was complete and accurate at the time of printing, Polycom, Inc., cannot assume responsibility for any errors. Changes and/or corrections to the information contained in this document may be incorporated into future issues.

Table of Contents

1. Introduction	4
1.1 Icons and Conventions	4
2. Capacities and Specifications	5
2.1 Overview	5
2.2 Identification Numbers	5
2.3 KIRK Wireless Solution Diagram	7
3. Radio Coverage and Physical Deployment	8
3.1 Radio Coverage Areas	8
3.2 Deployment	8
3.3 Measuring Radio Coverage	15
3.4 Using the Handset as a Signal Meter	16
3.5 Signal Meter Display	17
3.6 Completing the Site Survey	19
3.7 KIRK Radio Hardware	20
4. KIRK Wireless Server 1500 Solution	25
4.1 Internal Hardware	25
4.2 Accessories	29
4.3 KIRK Programming Tools	30
5. Installation of the KIRK Wireless Server 1500 Solution	31
5.1 Internal Hardware Installation	31
5.2 Construction and Installation	32
5.3 Opening the KWS1500	32
5.4 Installing a KIRK Expansion Board 1500	34
5.5 Installing KIRK Analog Interface Cards	35
5.6 Wiring Base Stations	36
5.7 Base Station and Repeater Installation	37
6. Regulatory Notices	41

1. Introduction

This manual provides a complete discussion of the KIRK Wireless Server 1500. The purpose of this manual is to provide general and specific information relating to the deployment, physical installation, and tuning of the KIRK Wireless Server 1500, herein referred to as the KWS1500.

1.1 Icons and Conventions

This manual uses the following icons and conventions.



Caution! Follow these instructions carefully to avoid danger.



Note these instructions carefully.

2. Capacities and Specifications

2.1 Overview

A KIRK Wireless Solution, based on the KWS1500, is an adjunct solution for medium-to-large businesses with a need from anywhere between 1 and 128 handset users. The KIRK Expansion Board and the KIRK Link Card make it possible to expand the solution capacity to reach registration of up to 128 and 700 wireless users depending on the interface technology. The KWS1500 is deployed behind a new or existing host PBX telephone switch through analog station port connections provided by the host PBX.

A KIRK Wireless Solution consists of a KWS1500 operating in the Digital Enhanced Cordless Telecommunications (DECT) frequency band of 1.8GHz or 1.9GHz, and supports up to 16 KIRK Base Stations to deliver radio coverage for up to 64 KIRK Handsets.

To eliminate “blind spots” or to cover low traffic areas, KIRK Repeaters can be added to extend the radio coverage area of Base Stations. Up to six Repeaters can be connected per host Base Station (96 Repeaters total).

KIRK Base Stations

The Base Station is a compact device that contains radio frequency (RF) circuitry and radio antennas. The main function of the Base Station is to provide communication of audio and data signals between the mobile handsets and the KWS1500 Solution. Each KIRK Base Station supports four simultaneous voice conversations.

Up to three Base Stations may be placed adjacent to one another without causing channel interference. This provides the ability to support up to 12 simultaneous voice conversations in a given area. A fourth Base Station must be placed a minimum of 23 meters / 75 feet from a group of three Base Stations to avoid channel interference.

KIRK Repeaters

Repeaters extend the radio coverage of KIRK Base Stations by up to 50 percent. KIRK Repeaters do not require cabling to the KIRK Wireless Server or the host Base Station. Repeaters require local power and are synchronized to the host Base Station wirelessly.



A KIRK Repeater may only be synchronized to a single Base Station.

Handsets

The KIRK Handset is a lightweight, ergonomically designed wireless unit that includes a LCD display and keypad. The handset is compatible with the DECT Generic Access Profile (GAP) standard.

2.2 Identification Numbers

KIRK ARI number

The KIRK Access Rights Identity (ARI) number is an 11-digit number that specifically identifies the KIRK Solution. Each KWS1500 cabinet produces a unique ARI number that identifies it from any other KWS1500. The ARI number can be found on the back panel of the KWS1500 cabinet.

When using linked KWS1500s, the solution uses the ARI number from the KWS1500 assigned as the Master.

KIRK Handset IPEI number

Each KIRK Handset has a unique Equipment Production Identification number. This number uniquely identifies each handset. The KWS1500 assigns each handset to the solution by its International Portable Equipment Identity (IPEI) number, or serial number. The IPEI number is printed on the label inside the battery compartment. It is also available by dialing the feature code ***99984*** on the idle handset, and pressing the **OK** button.

The IPEI number is a 12-digit number. It appears on all KIRK handset equipment as follows:

00077 1234567

2.3 KIRK Wireless Solution Diagram

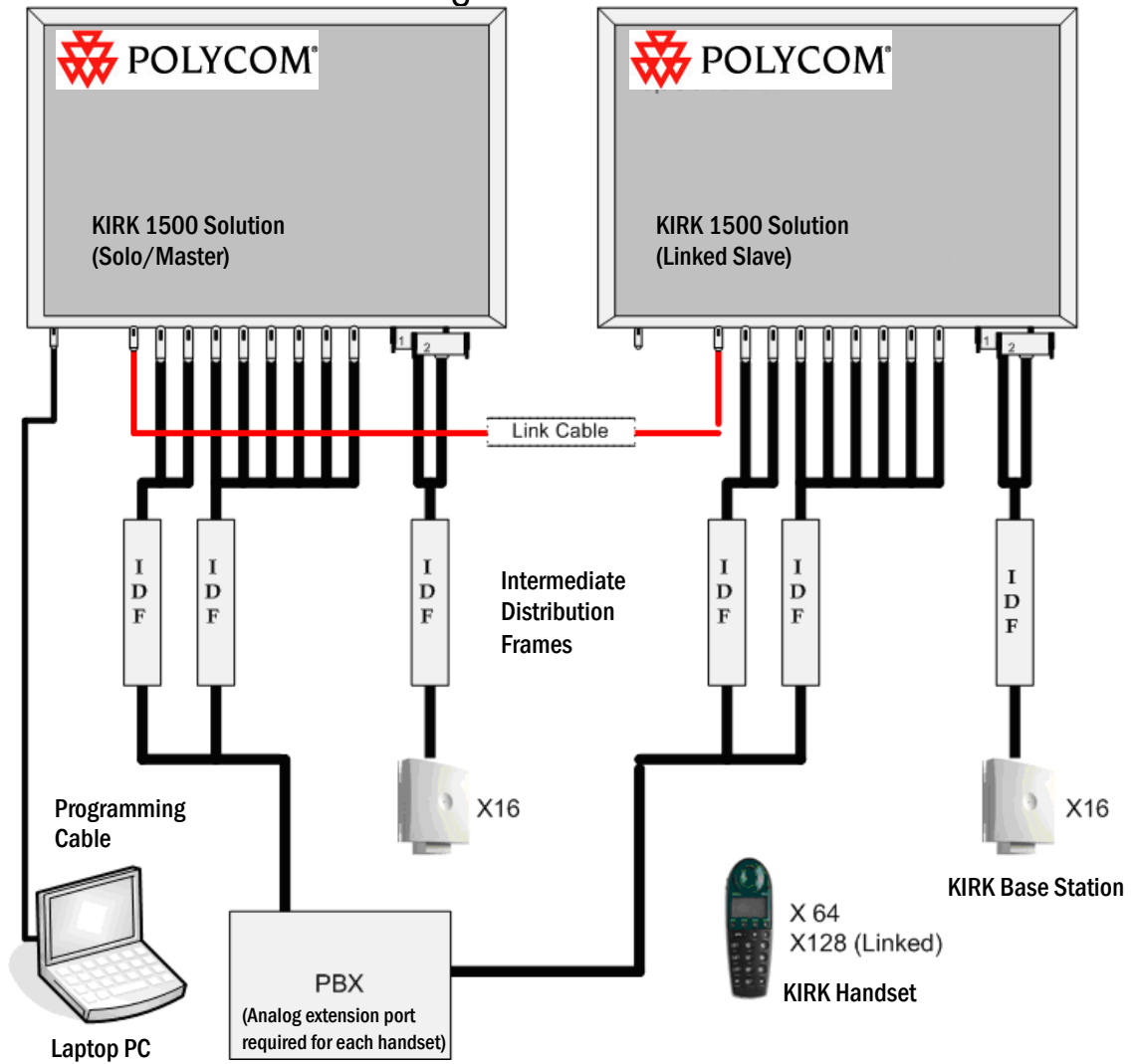

3. Radio Coverage and Physical Deployment

3.1 Radio Coverage Areas

The deployment of Base Stations and Repeaters is a critical aspect of the KWS1500 Wireless Server. If the Wireless Server installation is to be successful, the deployment concepts explained here must be followed.

To determine the permanent installation location of Base Stations within a given installation, a site survey must be taken to discover the optimal location and total quantity of Base Stations required for the installation.

KIRK Base Stations provide a radio coverage radius of approximately 47 meters / 150 feet indoors or up to a 350-foot (106 meters) radius outdoors in direct line-of-sight conditions. However, it is extremely important to keep in mind that **radio coverage is dependent on construction materials, method of construction and environment**. These factors will always be involved in every installation. Therefore, it is not possible to relate one installation to another insofar as number of Base Stations or positioning of Base Stations. Each site is relatively unique.

While an extensive guide to effective RF coverage planning is outside the scope of this manual, the following points should be taken into consideration when planning the site, prior to installation.



Specifications listed reflect capacities of the KWS1500 solution when used in a Solo configuration unless otherwise designated.

- The Base Station provides a typical coverage radius of 150 feet (46 m) in a typical indoor office environment, and up to a 350-foot (107 m) radius in an open area (line-of-sight), extending in all directions from the Base Station. The exact coverage range depends on the building architecture and materials.
- The KWS1500 will support a maximum of 64 handsets per solution. .
- The KWS1500 supports a maximum of 16 Base Stations per solution, providing 64 RF speech channels.
- A maximum of two KWS1500 solutions may be linked together.
- Handsets can move between coverage areas of different Base Stations while receiving continuous service and maintaining conversations in progress.
- For efficient handoff of conversations between Base Stations, deploy multiple Base Stations with sufficient overlap of coverage between them (i.e. plan for some areas to be covered by more than one Base Station). Overlaps are necessary to allow handsets the time necessary to handoff to a Base Station with a stronger signal.
- Avoid placing Base Stations near other electronic equipment, large machinery, etc., as the range can be severely affected.
- Base Stations should be placed between 1,8 and 2,4 meters / 6 and 8 feet in height; if they are placed any lower, persons walking around could interfere with the radio signal. Antennas should always be mounted in a vertical orientation utilizing the supplied mounting bracket. Coverage area can be adversely affected if the Base Stations is mounted improperly.

3.2 Deployment

It is important to keep in mind that the coverage area of the KWS1500 and any repeater is flexible and affected by outside objects. It should be noted that within the course of this

guide coverage areas are represented by abstract areas and bear no resemblance to the actual physical coverage area provided by the KWS1500.

Coverage Area Calculations

One Base Station:

$$\text{Coverage } A = (\pi \times r^2)$$

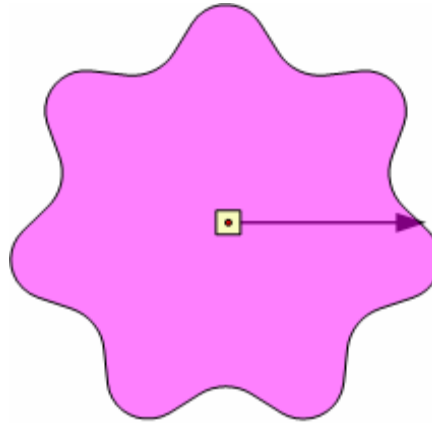

Approximate
Coverage Area

$$A = \pi \times r^2$$

Extending Radio Coverage with Repeaters

A KIRK Repeater is a useful tool for extending a Base Station's coverage area. It is therefore ideal where extra coverage is required in a low traffic area.

KIRK Repeaters do not provide additional active speech channels to the KIRK Wireless Server. Instead, the Repeaters extend up to 2 simultaneous traffic channels of the host Base Station. Base Stations do not handover speech channels to the Repeater, therefore when a Wireless Handset is off hook using a Repeater channel, the associated base Station channel also remains in use. A Repeater only takes channels from a Base Station when there is active traffic on the Repeater.

Multi Cell Environment

In a multi cell environment, up to 3 Repeaters may be synchronized to a single Base Station to extend the radio coverage.

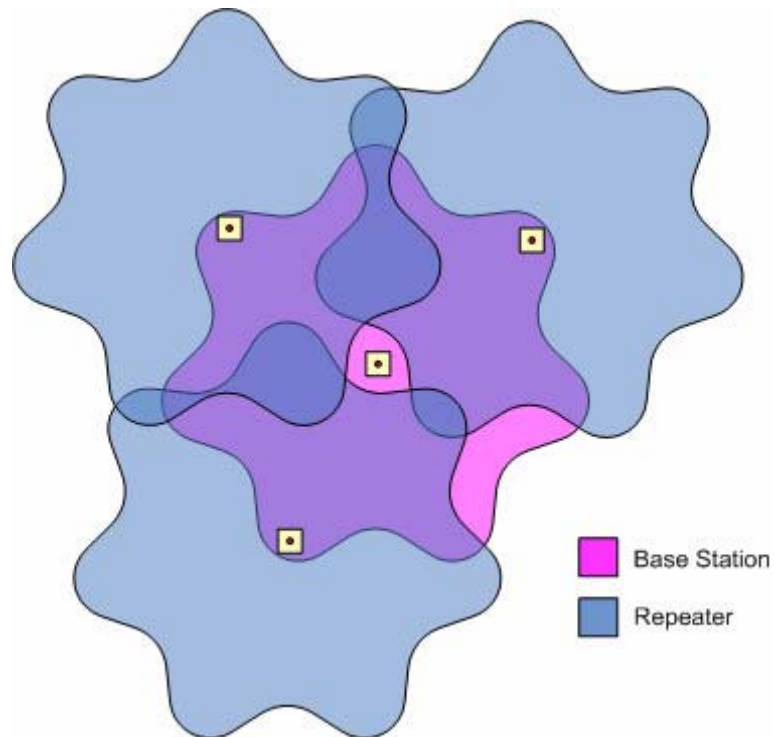

Jump Configuration

Repeaters may also be configured in a "jump" configuration. In this configuration the Repeater closest to the Base Station is the only Repeater in the chain that is synchronized to the Base Station. Subsequent Repeaters are synchronized to the previous Repeater in the chain.

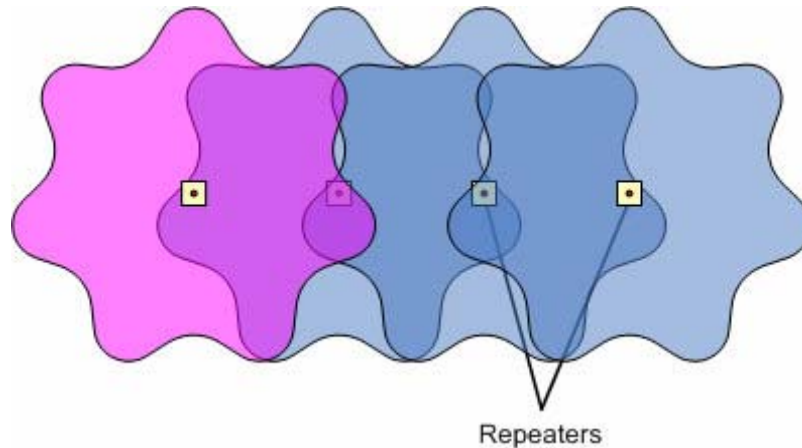

Radio coverage overlap

Other factors involved in a deployment relate to radio coverage overlap. A coverage overlap occurs when the radio fields of multiple Base Stations overlap each other. Base Stations must be placed in such a way that the radio coverage from one Base Station to another overlaps by 9 to 14 meters / 30 to 45 feet. An overlap is required so that as the

handset moves about the various coverage zones Base Stations have time to hand the call off to another Base Station. .

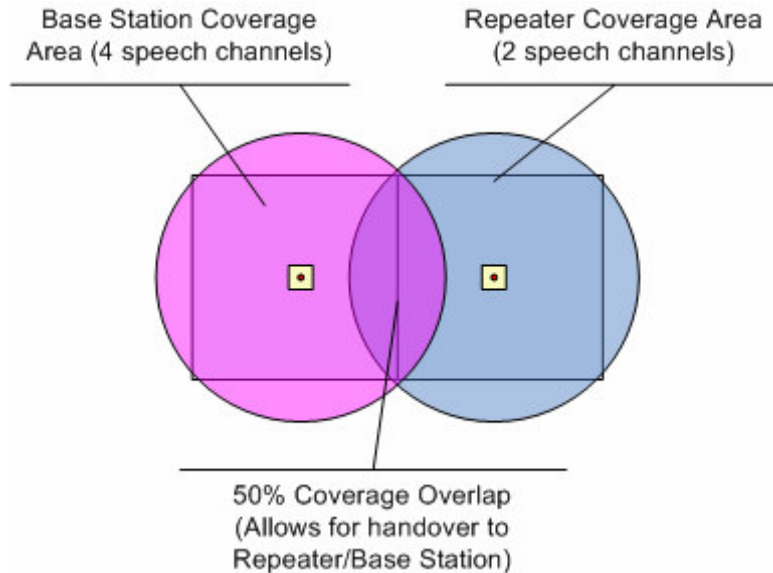

If the overlap area is not enough (less than 9 to 14 meters / 30 to 45 feet), there is a risk of dropping the connection while moving from one coverage area to another. This is because of the time that the handset needs to scan for an alternative Base Station. However, too much overlap results in a wasted coverage area.

If the alternative Base Station is not found while crossing the overlap into another area, a channel handoff cannot take place and the connection to the solution will be dropped because the handset is now out-of-range.

Horizontal and vertical overlap

Base Stations are omni-directional, meaning RF signal is propagated vertically and horizontally from the Base Stations and Repeaters. Depending on building materials, the Base Station coverage area will typically extend to more than one floor of a structure. In the multi-zone building installation below, the coverage areas overlap horizontally, allowing the handset to roam the structure without interruption. The handsets will always try to acquire the Base Station with the strongest signal if there are channels available on the Base Station.

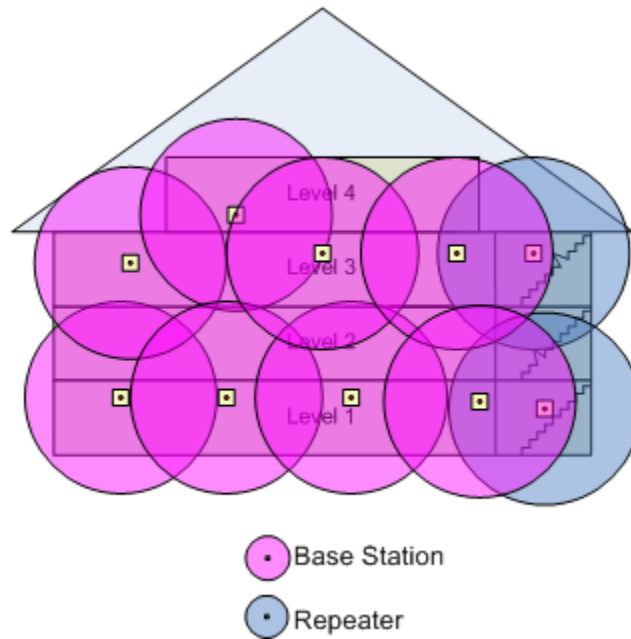

No overlap

In areas where two Base Stations are separated by steel doors, gates, elevators, stairwells, etc., the handset may not have time to register with the next Base Station, resulting in the call being dropped. This can be resolved by moving the Base Stations closer together, or by installing another Base Station near the obstruction.

If the overlap area is not enough (less than 9 to 14 / 30 to 45 feet), there is a risk of dropping the connection while moving from one coverage area to another. This is because of the time that the handset needs to scan for an alternative Base Station. Too much overlap results in a wasted coverage area, and too little results in dropped calls.

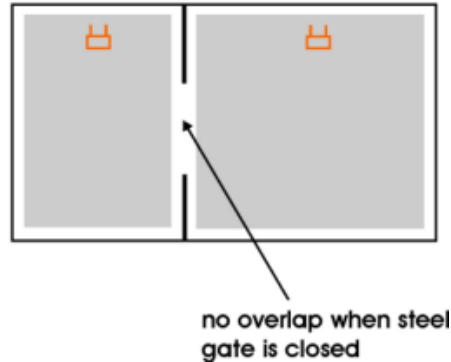

Small overlaps

In this example, two coverage areas meet at a perpendicular intersection such as a hallway or outside of a building corner. When moving around in the area where little or no overlap occurs, there is a chance the call may drop. This is because the handset does not have time to register with the second Base Station before the handset has exited the coverage area of the first Base Station. This can be solved by placing another Base Station or KIRK Repeater in the corner of the meeting corridors to provide extra coverage.

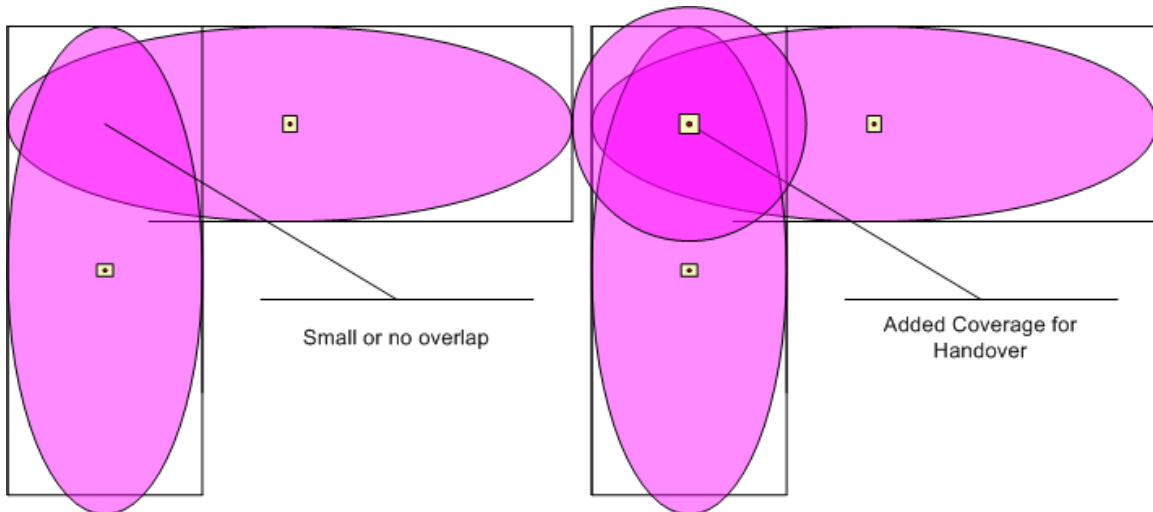

Many small overlaps

Be aware that many small overlaps in the same area can create problems if a handset can only identify two Base Stations. For example, if the handset is located in such an area and it is moved in a given direction, the alternative Base Station chosen may be different than the Base Station towards which the handset is traveling. This situation can cause a dropped call.

The best solution is to place a Base Station in the middle of the area where there is merging radio coverage.

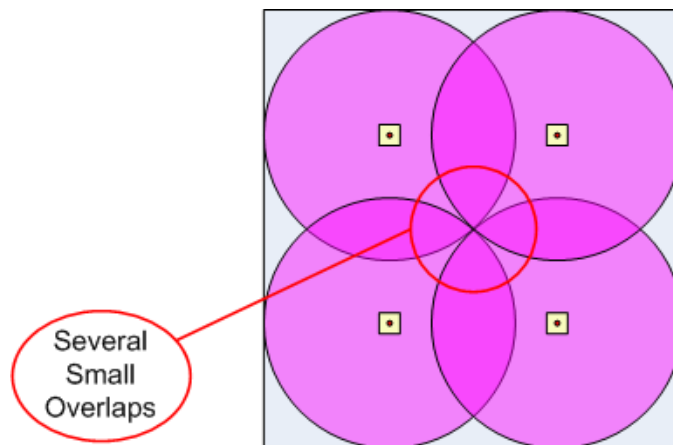

Coverage hot spots

Each Base Station supports four simultaneous conversations. In some applications, more channels are needed in a dense area. To support these installation requirements, up to three Base Stations can be placed in the same general area to provide extra traffic capability. This area is referred to as a "hot spot." Hot spots are generally used in common areas of a building that will require more traffic channels than a single Base Station can supply.



Base Stations must be separated by at least 4 to 9 meters / 15 to 30 feet to avoid conflicts. If a fourth Base Station is required in a high traffic area, to prevent interference it must be placed at least 22 meters / 75 feet away, if a direct line of sight exists between the fourth Base Station and the group of three.

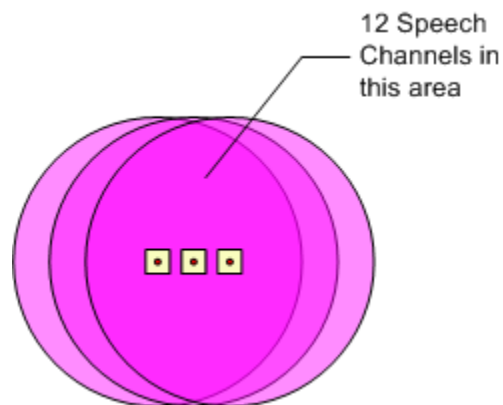

Shadows

Be aware that “shadows” created by parts of the building can cause spots where no radio signals are able to penetrate. If a Base Station is mounted on a concrete or steel pillar, or even mounted near steel shelves, shadow areas may occur. This should be resolved by placing extra Base Stations near the shadow areas.

Firewalls/ doors, metal siding or linings, etc., might create these shadows.

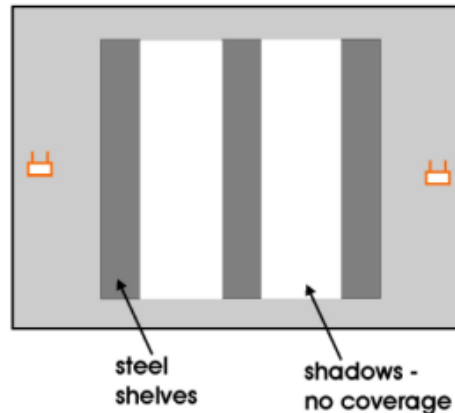

Weather conditions and seasons of the year

Different weather conditions can have an influence regarding radio coverage. For example, rain, dense fog, a wet or icy roof or wall, can act as an RF shield.

Different seasons of the year can also have an influence regarding radio coverage. For example, the growth of leaves on trees in the spring that were not present when the solution was installed in the winter might affect the radio coverage of Base Stations or Repeaters.

3.3 Measuring Radio Coverage

The radio coverage provided by Base Stations and Repeaters is related in two separate but equally important values. These two values are referred to as the Q-value, and the Radio Signal Strength Indicator, or RSSI. The KIRK Handset can be used as a signal meter for measuring these values.

Q-value

The Q-value is a relative expression for the bit failure rate in the communication between the Base Stations and the handset. The highest possible Q-value is 64; at this value there is a very low bit failure rate and should provide excellent speech quality.



As the wireless handset roams the coverage area, the Q-value will change. When the wireless handset registers a Q-value of 52 (12 bit failures measured), the wireless handset will request a handover to an alternative Base Station or Repeater or eventually to another channel, frequency or timeslot.

Be aware that the information in the display is only updated once per second meaning that the number of bit failure can be lower or higher than indicated in the display. Therefore it is important to accept that as soon as significant fluctuation of the Q-value occurs the end of the radio coverage has been reached.

RSSI value

The Radio Signal Strength Indicator value is a relative expression for the field strength of signal from the Base Station. The RSSI value is used for the choice of the alternative Base Station(s).

The handset will choose the Base Station from which the strongest RSSI signal is received as the first alternative Base Station. Alternative Base Stations are listed according to RSSI values. If the "Best alternative Base Station" disappears, the next Base Station with the highest RSSI value will become the "Best alternative Base Station."

RSSI value display

The RSSI value of Base Stations can be viewed by the handset when used as a signal meter. This value is related in a two-digit numerical format. However, the RSSI value may be a three-digit value (i.e. greater than 99). In this case, the handset uses a punctuation symbol to indicate this condition. This punctuation symbol should be read as "100 + the number shown."

For instance, to relate a RSSI value of 99, the digits **99** will be shown in the display. To relate a RSSI value of 106, the value may appear as **: 6** or **; 6**. The punctuation value shown may change; however, the meaning remains the same.



To provide for quality speech, the RSSI value is normally not accepted as lower than a loss of 25dB relative to the signal which is 100% measured near to the KWS1500. **If the signal loss rises to more than 25dB within the desired coverage area, plan to install a KIRK Repeater to improve coverage.**

When measuring for placement of Repeaters, the signal loss of the KWS1500 (or KIRK Repeater in a linear configuration) should not be higher than 25dB at the location chosen for mounting the Repeater.

3.4 Using the Handset as a Signal Meter

During a site survey, the handset can be used as a signal meter to measure the radio signal strength and bit-failure rate of the KWS1500 and Repeaters and determine their optimal locations.

Radio coverage is measured by a combination of the Q-value and RSSI value, shown in the handset's display as described below. If the values are not adequate in a sector of the coverage area (Signal loss of more than 25dB and Q-value less than 60), the KWS1500 may need to be moved to a better location, and / or KIRK Repeaters may need to be installed.





All signal measurements must be taken with the subscribed handset off-hook and in a call to monitor voice quality.



It is recommended to use a headset to assist with measuring radio signal strength. This allows you to listen to the quality of the voice while simultaneously viewing the signal values on the handset's display screen.

Activating the signal meter (3040, 4020, 4040)

- Turn the handset on (press the  key for one second).
- Dial  (make sure that the “key lock” is not active).
- Press the  MUTE key; the Signal Meter will appear.



3040, 4020, 4040
Signal Meter

Activating the signal meter (5020, 5040)

- Turn the handset on (press the left softkey for one second).
- Dial  (make sure that the “key lock” is not active).
- Press the R key, and wait for signal data to be received; the Signal Meter will appear.



5020 Signal Meter

Performing measurements (3040, 4020, 4040)

- Take the handset off-hook by pressing the  key.
- Place a call to a destination.
- Place your hand over the top of the handset to simulate actual usage.
- Monitor the values displayed.

Performing measurements (5020, 5040)

- Take the handset off-hook by pressing the  key.
- Place a call to a destination.
- Place your hand over the top of the handset to simulate actual usage.
- Monitor the values displayed.

Turning off the Signal Meter (3040, 4020, 4040)

To exit the Signal Meter mode, press and hold the  REDIAL key for two seconds. The handset will return to the idle condition.

Turning off the Signal Meter (5020, 5040)

To exit the Signal Meter mode, press **Exit**.

3.5 Signal Meter Display

The Signal Meter Display includes the Q-value, RSSI value, hopping sequence, time slot and handoff information for Base Stations and all Repeaters located within the range of the handset. Base Station and Repeater numbers are shown in hexadecimal. Refer to the included chart for translation.

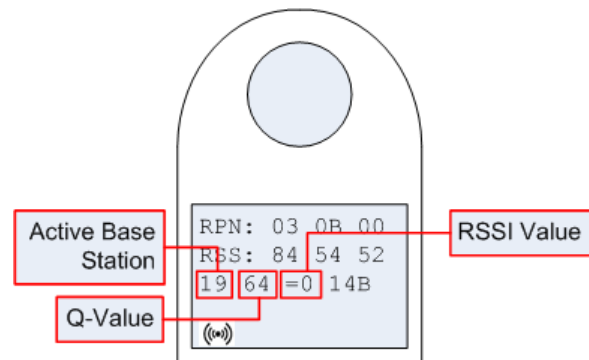

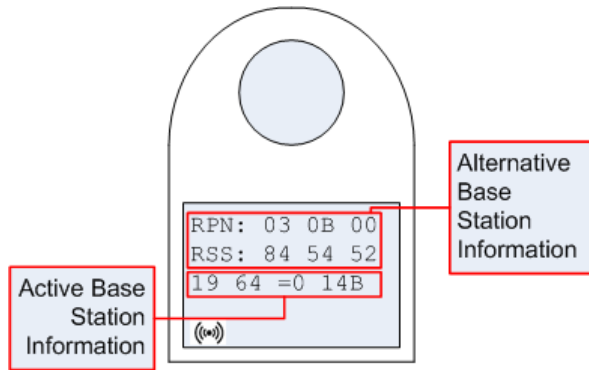

Along the bottom row of the display, the values for the closest Base Station or Repeater are reported. From left to right in the display, the information includes the number of the Base Station or Repeater, the Q-value, and the RSSI value. The remaining numbers are not of value to the measurement process. Should the handset be taken off-hook in this location, this is the Base Station or Repeater that would most likely be activated. This is referred to as the "active" Base Station.

Each Base Station and Repeater within range of the handset is listed to the right of RPN (Radio fixed Part Number), with its corresponding RSSI value below it, to the right of RSS. Alternate Base Stations and Repeaters are prioritized by RSSI value.

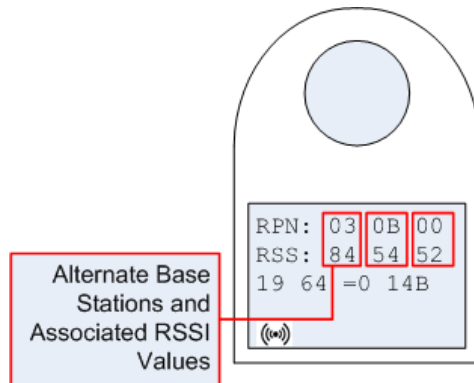

In this example, the handset is actively synchronized to Base Station 25 (Hex value **19**) with a Q-value of **64**. The handset is also within range of Base Station **03** with RSSI value of **84**. When the Q-value of Base Station 25 drops to around **52**, the handset will request a handoff to the Base Station/Repeater with the highest RSSI value, if available. In this case, the handoff would be given to Base Station **03** with RSSI value of **84**.

Site Survey Technique

Starting near the KWS1500, use your KIRK Handset to place an active call to another telephone to monitor voice quality. Walk away from the KWS1500 while monitoring signal values to find the limits of the coverage. Roam to each room or area of the facility where coverage is desired.

Monitor the Q-value while moving away from the KWS1500. If the Q-value drops to 52 or becomes unstable (fluctuating) the limit of the radio coverage has been reached. Walk back to an area where the Q-value stably measures at least 60, and the signal loss is not higher than 25dB, and mark the location to install a KIRK Repeater.

During measurement of radio coverage, it is important to simulate the influence of the human body and normal usage of the handset. This can be done either by shielding the antenna by the hand, or by turning the handset and the body in a way to achieve a "worst case" situation for reception of the radio signal from the Base Station.

Hexadecimal numbering of Base Stations

When using the handset as a signal meter, Base Station numbers are shown in hexadecimal format as follows:

Base Station	Hexadecimal	Base Station	Hexadecimal
00	00	16	10
01	01	17	11
02	02	18	12
03	03	19	13
04	04	20	14
05	05	21	15
06	06	22	16
07	07	23	17
08	08	24	18
09	09	25	19
10	0A	26	1A
11	0B	27	1B
12	0C	28	1C
13	0D	29	1D
14	0E	30	1E
15	0F	31	1F

3.6 Completing the Site Survey

By the end of the site survey, you should have established the optimum locations for the Base Stations and any necessary Repeaters. Mark these locations clearly and plan out how you will provide electrical power for Repeaters, if not yet in place.

3.7 KIRK Radio Hardware

KIRK Base Stations

KIRK Base Stations are compact devices that contain RF circuitry and transmit/receive antennas. The main function of the Base Station is to provide audio and data communication between the handsets and the KWS1500. The KIRK Base Station controls the traffic channels in the air and works as a link between the handsets and the KWS1500.

The KWS1500 operates the Base Stations through a wired standard twisted pair of cables. Only one pair is required per KIRK Base Station and, by using recommended Cat 5 cabling, Base Stations may be placed up to 2.5 km / 9,000 feet from the KWS1500 main cabinet. A Base Station does not require an external AC power source. Instead, the Base Station is directly powered through the cabling from the KWS1500. .

Base Stations are designed with two internal antennas and support antenna diversity. The Base Station is also able to carry out handoff between the RF channels under the same Base Station, and supports up to four simultaneous speech channels.

Base Stations are omni-directional and provide a radio coverage radius of around 47 meters / 150 feet indoors, or 106 meters / 350 feet outdoors in direct line-of-sight conditions.

It is not possible to define a more exact size of a KIRK Base Station coverage area, as it largely depends on location specifics such as building materials, etc. Before a KIRK Wireless Solution is installed, a careful site survey should be performed in order to accurately define how many Base Stations are required to provide the necessary coverage at each individual site. Site surveys are also used to locate the optimal locations for each Base Station and, if needed, locations for KIRK Repeaters.

It is possible to connect 16 Base Stations to a single KWS1500. Base Stations 0 to 7 are supported by the KWS1500 motherboard. Base Stations 8 to 15 are supported by the KIRK Expansion Board 1500.

By linking two KWS1500 units together using the KIRK Link Card, 32 Base Stations can be connected.

Each Base Station supports four simultaneous conversations. In cases where more than four simultaneous conversations are commonly required, multiple Base Stations may be placed to create "hot spot" zones to provide high traffic capacity areas.



Base Stations are also termed Radio Fixed Part (RFP).

All Base Stations should be cabled using 24-gauge, Cat 5, twisted-pair cable. Terminate the Base Station end of the twisted-pair cable with an RJ-11 connector on the center pair. Base Stations are not polarity sensitive.

It is important that Base Stations are installed where the coverage is required. Therefore, Base Stations can be installed either indoors or outdoors.

- Indoors, the Base Stations must be mounted in a vertical orientation to a suitable, non-metallic, flat surface such as a wall or post.



Outdoors, the Base Station must be placed inside of a weatherproof, environmentally protected housing, and mounted in a vertical orientation to a suitable, non-metallic, flat surface such as a wall or post.

KIRK Base Station specifications

Frequency:	1.8GHz and 1.9 GHz
RF channels:	10
Active speech channels:	4
Aerials:	Antenna diversity
Transmit range:	Indoors: approx. 150' radius
	Outdoors: approx. 350' radius
Protocol:	/GAP
Power requirements:	9V DC
Dimensions (L x H x D):	100 x 100 x 36mm/4" x 4" x 1.5"
Weight:	172 grams/6 oz

KIRK Repeaters

The KIRK Repeater is a building block to be used to extend the coverage area in a KIRK solution. The repeater does not increase the number of traffic channels, however it provides a larger physical spreading of the traffic channels and thereby increases the coverage area established with the KIRK Base Stations. The repeaters are mainly used in areas with limited traffic. The KIRK Repeater is available with either 2 or 4 voice channels. It is wireless and does not need physical connection to the KIRK Wireless Server, making it very easy to install. The repeaters can be supplied with an external antenna making it possible to create radio coverage in a remote area without cabling to the rest of the installation. .



When deploying, KIRK Repeaters must be installed within the coverage area of the host Base Station. The RSSI value of the hosting Base Station, (measured at the installation point of the Repeater), must be 90 or greater.

Repeaters require a standard 120V AC power outlet within 1.8 meters / 6 feet of placement.

Up to six KIRK Repeaters may be synchronized to a single KIRK Base Station, and a maximum of 96 Repeaters may be used on a KWS1500.

Repeaters may be configured in multi-cell configuration with multiple Repeaters assigned to a single Base Station, or in a linear configuration with up to three Repeaters in a chain.

The Service Tool software is required to program Repeaters. See *Service Tool Program Administration Guide*.

Multi-cell environment

In a multi-cell environment, up to six Repeaters may be synchronized to a single Base Station to extend the radio coverage area.

Repeaters must be placed inside the coverage area of the hosting Base Station.

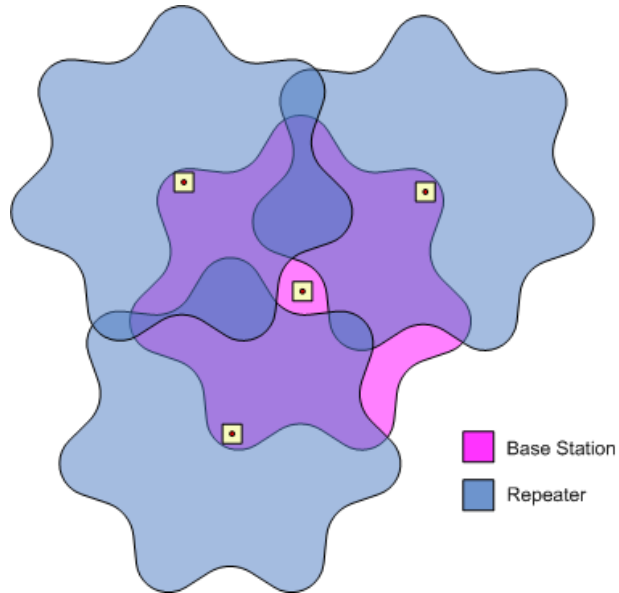

Jump configuration

Repeaters may also be configured in a linear "jump" configuration. In this configuration, the Repeater closest to the Base Station is the only Repeater in the chain that is synchronized to the Base Station. Subsequent Repeaters are synchronized to the previous Repeater in the chain.

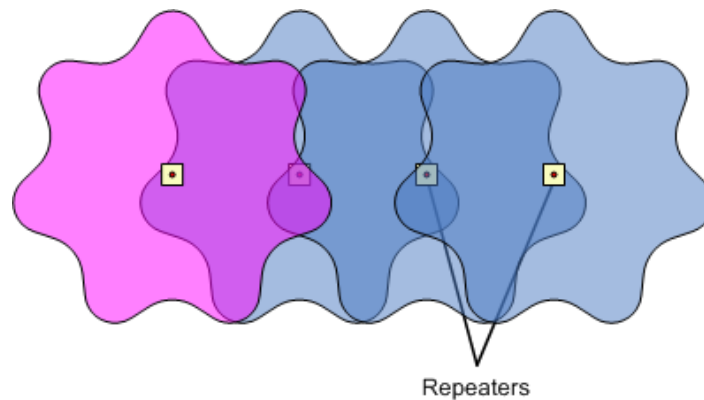

KIRK Repeater specifications

Frequency:	1.8 GHz and 1.9 GHz
Transmit range:	Dependant on building materials
Protocol:	/GAP
Power requirements:	9V DC
Dimensions (L x H x D):	100 x 100 x 36mm/4" x 4" x 1.5"
Weight:	156 grams/5.5 oz
Active speech channels:	2 to 4, software-controlled

KIRK Handsets

The KWS1500 supports the KIRK 3040, KIRK 4020, KIRK 4040, KIRK 4080, KIRK 5020 and the KIRK 5040.



KIRK 3040



KIRK 4020



KIRK 4040



KIRK 4080



KIRK 5020



KIRK 5040

The KIRK handsets are based on the Digital Enhanced Cordless Telecommunications (DECT) technology, and comply with the GAP standard.

For information on how to register, add, edit, move or delete a KIRK Handset on a KWS1500, please consult the KIRK Wireless Server 1500 Administration Program Software Guide (72-1602-00, Issue B)

4. KIRK Wireless Server 1500 Solution

4.1 Internal Hardware

KIRK Wireless Server 1500

The KWS1500 is a fully digital wireless mobility server (voice) operating on a frequency of 1.8 GHz and 1.9 GHz. As the central control unit, the KWS1500 processes advanced tasks such as handoff synchronization, echo cancellation, and line delay compensation.

Each KWS1500 includes connections for up to eight Base Stations, and one DB9-pin serial port for local programming, laptop connection, and SIO (serial input/output) access.

Up to eight KIRK Analog Interface Cards and one KIRK Expansion Board 1500 may be installed to expand the size and functionality of the server.

To further increase the capacity of the solution, a Link card module can be installed to link two KWS1500 units together.

The expansion modules that will be accepted by the control unit include:

KIRK Expansion Module	Solution Capacity	Link Capacity
KIRK Handset	64	128
KIRK Analog Interface Card	8	16
KIRK Link Card	1	—
KIRK Expansion Board 1500	1	2
KIRK Base Station	16	32
KIRK Repeater	96	192



KIRK Wireless Server 1500 specifications

Frequency:	1.8 GHz and 1.9 GHz
Output power:	125 mW
Frequency deviation:	186 KHz
Bit rate:	1.024 Mbit/s
Receiver sensitivity:	< -86 dBm
RF channels:	5
Voice CH/RF (total):	10 (120)
Data throughput:	256 Kbit/s
Power Requirement:	110/240V AC
Specification:	ETSI
KWS1500 expansion:	2 x KWS1500 units per PABX
Base Station capacity:	32 (16 per KWS1500)
Repeater capacity:	192 (96 per KWS1500)
Handset capacity:	128 (64 per KWS1500)
Configuration setup:	Via PC (direct to serial port or via modem)
Dimensions:	400 x 320 x 150 mm/15.7 x 12.6 x 5.9 inches
Weight:	8.3 kg/18 lb 4 oz

KIRK Expansion Board 1500

The KIRK Expansion Board 1500 provides the opportunity to create an interface for eight additional Base Stations in a KWS1500.

Each KWS1500 will support a maximum of one KIRK Expansion Board 1500, bringing the total number of Base Stations supported by a single KWS1500 to 16.



KIRK Expansion Board 1500

Specifications

Number of units per KWS1500:	1
Base Station capacity per card:	8

Analog Interface Card

The KIRK Analog Interface Card provides the analog tip/ring interface to the PBX. Up to eight analog interface cards can be connected to each KWS1500. One analog interface card channel is required per handset.

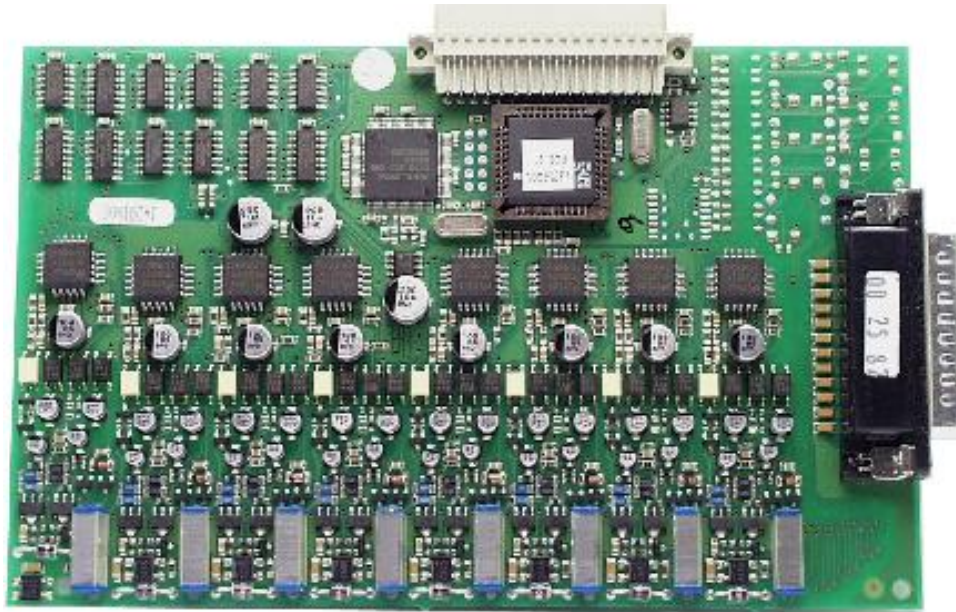

Analog Interface Card

Specifications

Number of units per KWS1500:	8
Signaling:	DTMF or Pulse
Disconnect signal:	Loop break/Earth pulse
Ringing frequency:	25 - 50 Hz
Public network:	Dial tone detect pause
Transmission:	Parallel operation down to 8 mA

4.2 Accessories

Deployment/Demonstration Kit

The KIRK Deployment Kit is used in the planning and development stages of a KIRK Wireless Solution. The Deployment Kit also makes an excellent demonstration kit.

The KIRK Deployment Kit includes two KIRK Handsets, two chargers with power supplies, and one KIRK Deployment Base Station.

Documentation is included.

KIRK Handset Charger

Charging your handset is easy. The handset charger is a neatly designed, well-functioning, state-of-the-art charger, which will fit into any environment. The power supply must be ordered separately.

KIRK Handset Programming Kit

The Handset Programming Kit is a state-of-the-art charger that also allows a user to connect to the handset with a laptop PC and the KIRK Service Tool Program.*

Included with the programming kit is a serial-to-RJ cable to connect to the laptop. The KIRK Service Tool Program and a Y-splitter cable are also required for handset programming, and are sold separately.

Use the KIRK Handset Programming Kit to change:

- Startup text
- Handset software
- Phone book programming

* 3040 handsets require a special charger for this function.

KIRK Headset, Plantronics

When you wish to use both hands and be able to answer your telephone at the same time a headset is necessary. The Plantronics headset is notable for its lightweight construction, along with the versatility that allows easy switching from the ear hook to the headband fixture.

The headset's advantages include a background noise suppression microphone and an adjustable patented ear hook. It is designed to last, and guaranteed for two years from the date of production. The headset is delivered with both ear hook and headband.

KIRK Handset Safety Line

A safety line can be used to provide the best protection against damage caused by dropping the handset. Connect one end of the safety line to your handset and the other end to your belt. It can be used in conjunction with the belt clip.

KIRK Handset Leather Pouch

The black leather pouch with belt clip is used to absorb wear and damage to the handset. The leather pouch is also available with a carrying handle for the KIRK 3040 Handset.

KIRK Handset Belt Clip

The spring-loaded, black, plastic belt clip, easily attaches a KIRK Handset to your belt when not in use. It can be used in conjunction with the safety line.

4.3 KIRK Programming Tools

KIRK Administration Program

The KIRK Administration Program software is required to program the KWS1500. The Administration Program provides a graphical user interface that allows the programmer to add KIRK Analog Interface Cards, register handsets, perform Base Station cable delay measurements, and control many other options within the solution. A laptop PC and NULL modem cable are required for connection to the KWS1500. Check for the latest software revision of the Administration Program at www.polycom.com.

KIRK Service Tool

The KIRK Service Tool software is used to connect KIRK Repeaters to specific Base Stations. The Service Tool can also be used to assign the standby text presented when activating handsets. A laptop PC and KIRK Repeater Programming Cable are required to connect to a KIRK Repeater. Check for the latest software revision of the Service Tool at www.polycom.com.

Service cables

Service cables connect the KWS1500 to Base Stations and PBX Analog lines.

Cable Function	Cable Type	Description
Base Station Interface (1330 5200)	25-pin male	Connection from the KWS1500 to the IDF. Each cable supports 8 Base Stations.
Analog Interface (1330 4300)	25-pin female	Connection from the KWS1500 to the IDF. Each cable supports 8 analog PBX connections.
US Cable Package (1330 6001)	Cable Kit	Includes one each of the following: Base Station Interface cable Analog interface card cable KWS1500 server power cable NULL modem programming cable

Programming cables

Programming cables are used to connect the installation professional's programming PC to the KWS1500, KIRK Repeaters, and, in some cases, Handsets for programming additions and changes. (Power supplies not listed.)

Kit	Parts	Description
Repeater Programming Kit (0231 9508)	Service Tool Software Y-splitter cable Repeater Serial-RJ cable	Connects a laptop PC to a KIRK Repeater for programming assignment of the Repeater to a Base Station.
KWS1500 Programming Cable (part of 1330 6001)	NULL modem cable	Connects a laptop PC to the KWS1500. Allows connection from the Administration Program.
Handset Programming Kit (0231 9508)	Y-splitter cable Serial - RJ cable	Connects a laptop PC to the Handset via the Service Tool. Same as Repeater Programming Kit.

5. Installation of the KIRK Wireless Server 1500 Solution

5.1 Internal Hardware Installation

In this section we will discuss the physical construction of the KWS1500, and the installation of the KIRK Expansion Board 1500 and KIRK Analog Interface Cards.

Required tools

- #10 Torx screwdriver
- 3/16", 1/4", and 5/16" straight-blade screwdrivers
- #1 and #2 Phillips screwdrivers
- Diagonal wire cutters
- Long-nosed pliers
- Electrician's pliers
- Slip-joint pliers
- Standard crimping tool
- Adjustable wrench
- Socket wrench set
- Telephone cable cutters
- Telephone cable insulation strippers
- 16-foot (5 m) measuring tape
- Punch tool matching all telephone cable termination blocks used at the installation site
- Digital multi-meter (DMM)
- Telephone line test set capable of pulse and DTMF dialing
- Portable (laptop) personal computer capable of emulating an asynchronous ASCII data terminal and approved by the manufacturer to run the binary database save and restore utility, or portable asynchronous ASCII data terminal, or permanently installed, on-site, personal computer or ASCII data terminal

Optional tools

- Modular line polarity tester
- Flashlight
- Tone/continuity/talk battery generator
- Tone detector/amplifier probe
- Telephone line test set with MF tone signaling capability
- Alligator clip leads
- 3/16" and 1/2" cable staple gun
- Analog transmission analyzer

5.2 Construction and Installation

The KWS1500 should be installed on a desk, or wall-mounted using the included wall-mounting bracket. When installing the KWS1500, maintain a clearance of four inches around the chassis to provide adequate ventilation. For this reason, do not place any objects directly against the panels.

The KWS1500 requires a mounting area at least 18" x 15" plus additional space for installation of cross-connection blocks.

A dedicated power source is highly recommended; it should be located within 1.8 meters / 6 feet of the installation.

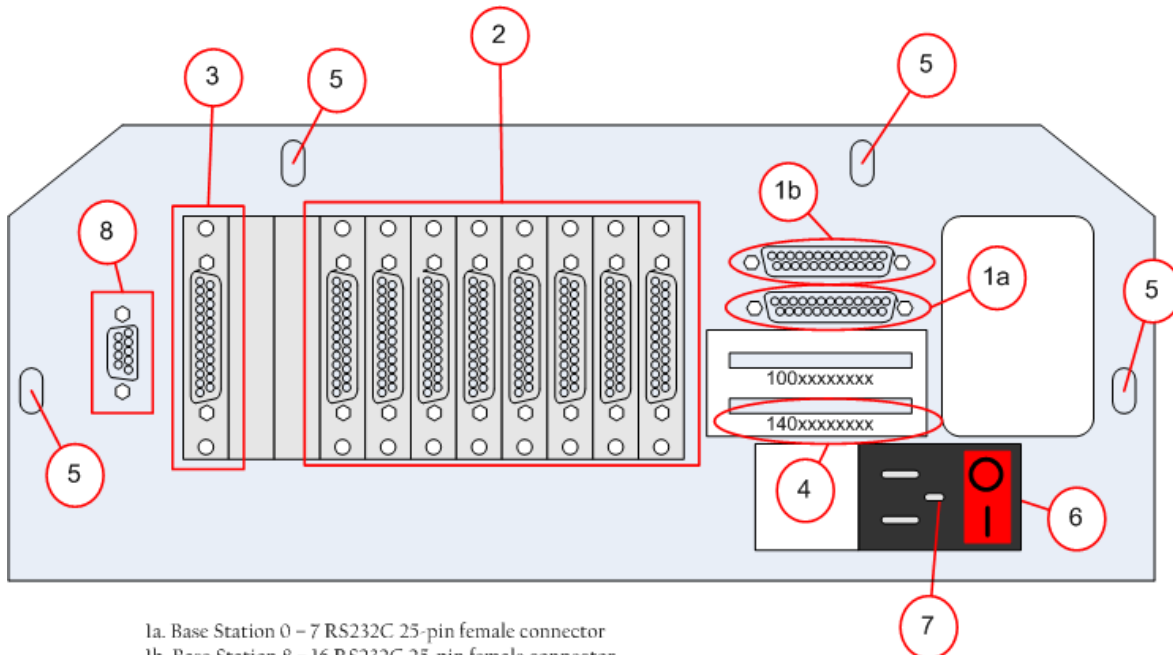

- 1a. Base Station 0 - 7 RS232C 25-pin female connector
- 1b. Base Station 8 - 16 RS232C 25-pin female connector
- 2. Analog Interface RS232C 25-pin male connectors
- 3. LINK cable connection
- 4. 2.4GHz KIRK 1500 Wireless Server ARI number
- 5. Mounting screw locations
- 6. Power on/off selector
- 7. 110V AC power connection
- 8. Local Maintenance RS232C 9-pin male connector

5.3 Opening the KWS1500



Do not remove the top cover while the unit is connected to a power source. Failure to disconnect the unit from the power source while the top cover is removed can cause severe electric shock, damage to electrical components, and even death.

Remove the eight screws connecting the cover to the chassis. There are two screws on each side of the chassis, and four located on the rear of the chassis. Once the screws are removed, gently lift the cover from the chassis and set it aside in a safe location.

Installation is the reverse of removal.

Inside the KWS1500

The KWS1500 provides connection points for up to eight analog interface cards, one Link card, and one KIRK Expansion Board 1500. (Base Stations 0 to 7 are supported by the KWS1500 motherboard).

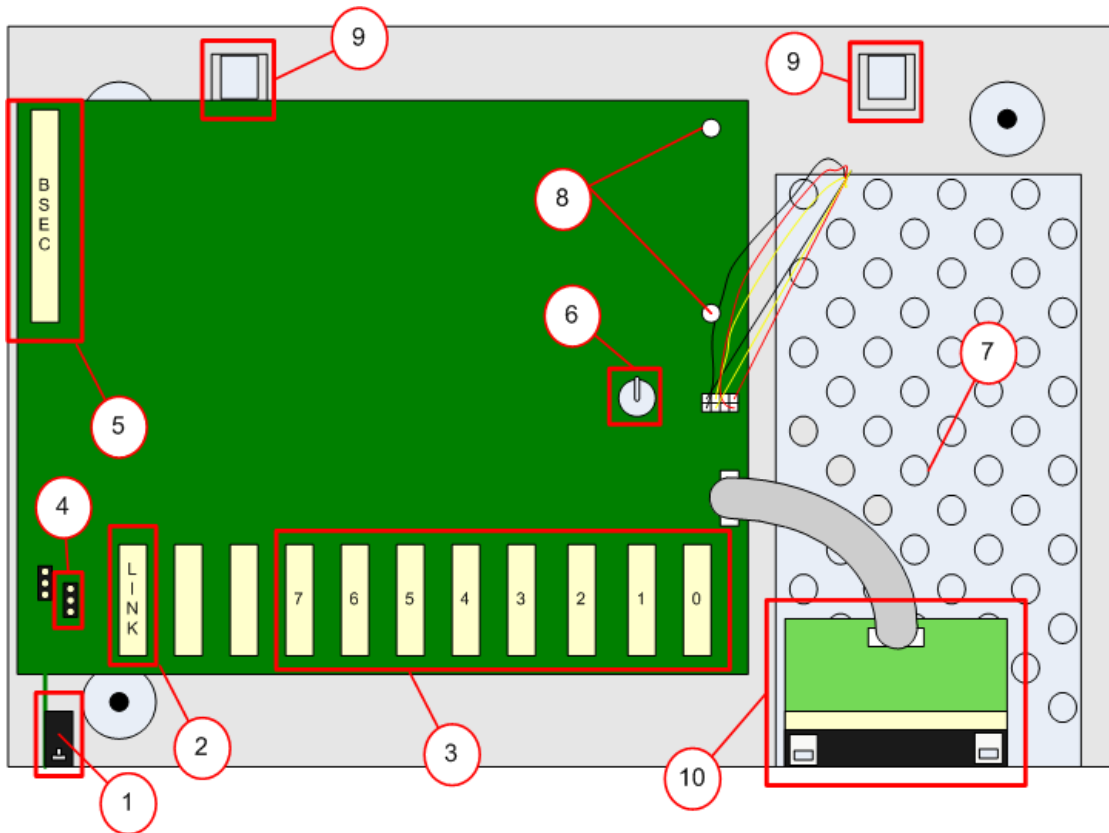

1. Local Maintenance connection
2. LINK card connector
3. Analog Interface card connections
4. MASTER / SLAVE Identification Jumper
5. Base Station Expansion Card connector
6. Backup Battery
7. Power Supply
8. Plastic stand-off positions for Base Station Expansion Card
9. Wall Mount tabs
10. Base Station connector(s)

KIRK Wireless Server 1500 Interior View

5.4 Installing a KIRK Expansion Board 1500

If the KWS1500 installation requires more than eight Base Stations, then a KIRK Expansion Board 1500 will be required. Installing a KIRK Expansion Board 1500 within the KWS1500 will increase its capacity to the maximum of 16 Base Stations. Follow these steps to install the KIRK Expansion Board 1500 within the KWS1500.

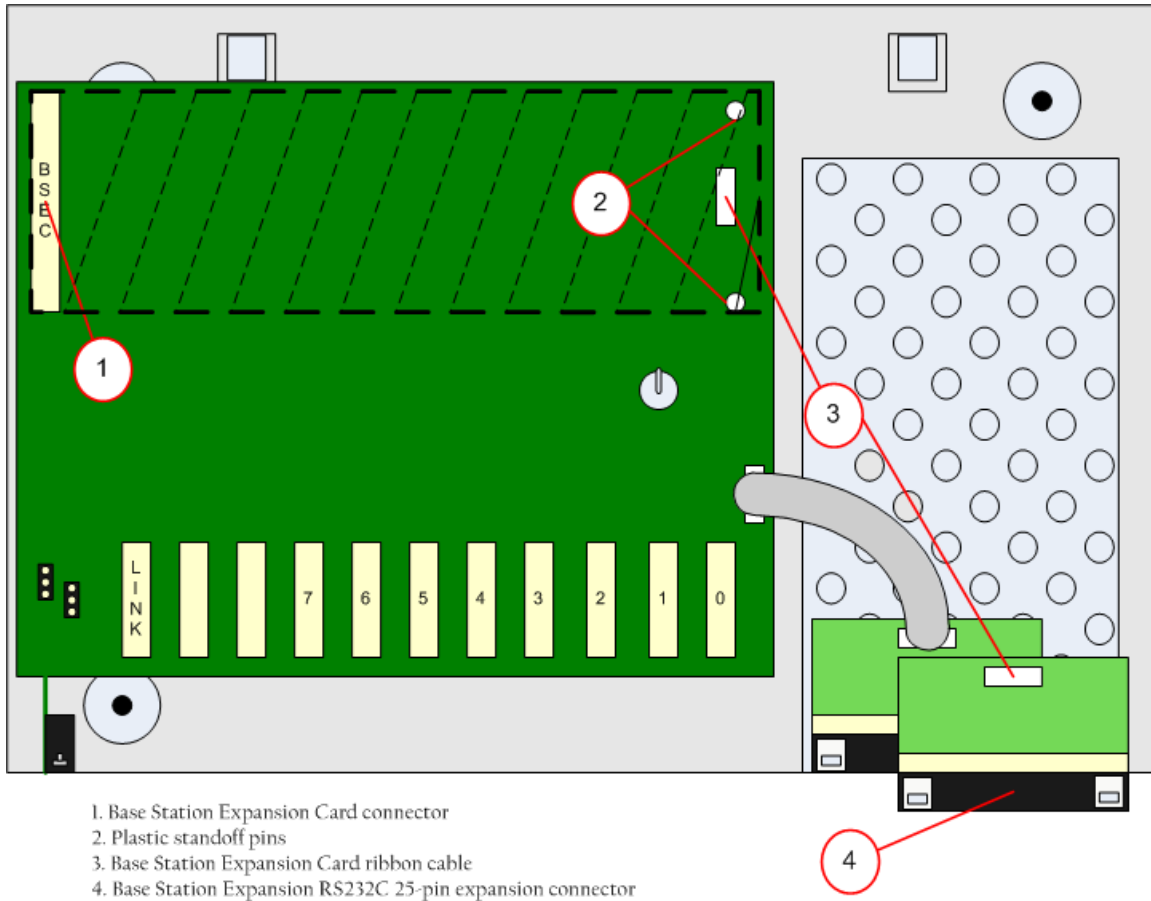

KIRK Wireless Server 1500 Interior View



Do not remove the top cover while the unit is connected to a power source. Failure to disconnect the unit from the power source while the top cover is removed can cause severe electric shock, damage to electrical components, and even death.

1. Disconnect the KWS1500 from AC power.
2. Remove the top cover of the KWS1500 by removing the eight screws securing the cover. There are two screws on each side of the unit and four on the rear.
3. Locate the KIRK Expansion Board 1500 connector and plastic stand-off pin positions on the motherboard.
4. Insert the two included plastic stand-off pins to the motherboard. Make sure they click into place and are secure.
5. Connect the KIRK Expansion Board 1500 to its connector, making sure the card is connected securely to the connector on the left side of the motherboard. Apply

- sufficient pressure to the right side of the expansion card, and make sure that the plastic stand-off pins click into place.
6. Carefully remove the DB25 blank panel on the rear of the KWS1500, and replace it with the expansion board DB25 connector. Use the two supplied screws to secure the DB25 connector to the KWS1500 case.
 7. Connect and secure the KIRK Expansion Board 1500 cable.
 8. Replace and secure the top cover.
 9. Cross-connect Base Stations 8 to 15 to the new DB25 connector.
 10. Power up the KWS1500 and make a cable delay measurement for all new Base Stations added to the solution.

5.5 Installing KIRK Analog Interface Cards

Analog interface cards connect directly to the host PBX via standard analog lines. Each handset is assigned to a single analog interface card channel, thereby obtaining a direct link to the host PBX.

Each handset requires a single, unique, analog line connection to the host PBX to provide a unique extension number per handset.

Each analog interface card supports up to eight analog lines, and therefore eight handsets.



Analog interface cards must be installed from right to left (slots **0** to **7**) in the KWS1500.



Do not remove the top cover while the unit is connected to a power source. Failure to disconnect the unit from the power source while the top cover is removed can cause severe electric shock, damage to electrical components, and even death.

1. Disconnect the KWS1500 from AC power.
2. Remove the top cover of the KWS1500 by removing the eight screws securing the cover. There are two screws on each side of the unit and four on the rear.
3. Using a flat-blade screwdriver and a pair of needle-nose pliers, gently pry and remove the metal punch-out to provide access to the expansion slot.
4. Remove the KIRK Analog Interface Card from its protective anti-static bag and insert it securely into the expansion slot.
5. Use the supplied screws to secure the DB25 connector to the KWS1500 case.
6. Connect and secure the KIRK Analog Interface Card cable.
7. Replace and secure the top cover.

Cross-connect the KIRK Analog Interface Card to the provided single line analog PBX lines.

Analog interface card cable wiring

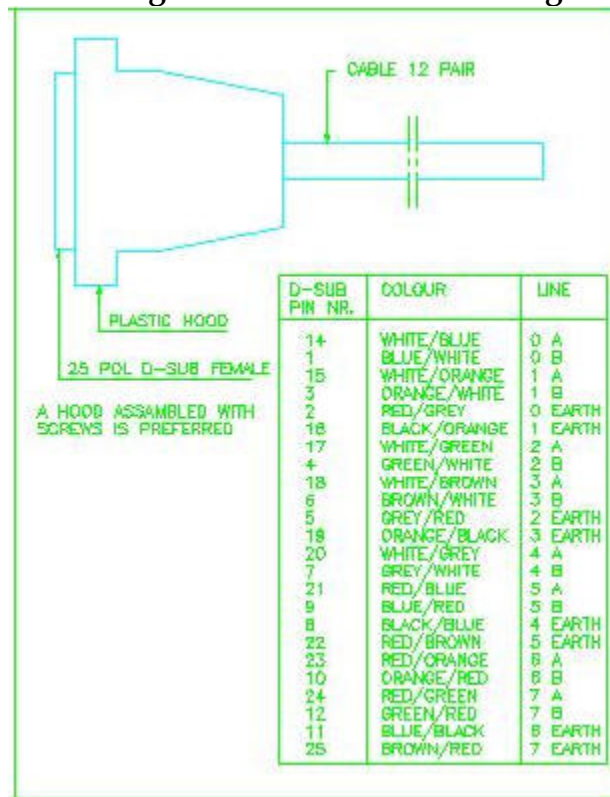

5.6 Wiring Base Stations

KIRK Base Stations are connected to the KWS1500 using a RS-232C 25-pin male cable connected to the RS-232C 25-pin female connector located on the rear of the KWS1500.

Terminate the Base Station cable to a suitable connection point such as a punch-down block or patch panel.

All Base Stations should be cabled using 24-gauge, Cat 5, twisted-pair cable. Terminate the Base Station end of the twisted-pair cable with an RJ-11 connector on the center pair. Base Stations are not polarity sensitive.

Terminate the solution end of the twisted-pair cable to a suitable connection point such as a punch-down block or patch panel located close to the termination of the Base Station cable. Cross-connect the Base Station cables to the desired Base Station circuit.

Power for the Base Station is provided by the KWS1500 and is delivered via the cable to the Base Station.

After the physical connection is made, the LED in the center of the Base Station will flash. This indicates that the Base Station is receiving power from the KWS1500.

Once the Base Station synchronizes with the KWS1500, the LED will light steady.

Base Station cable wiring

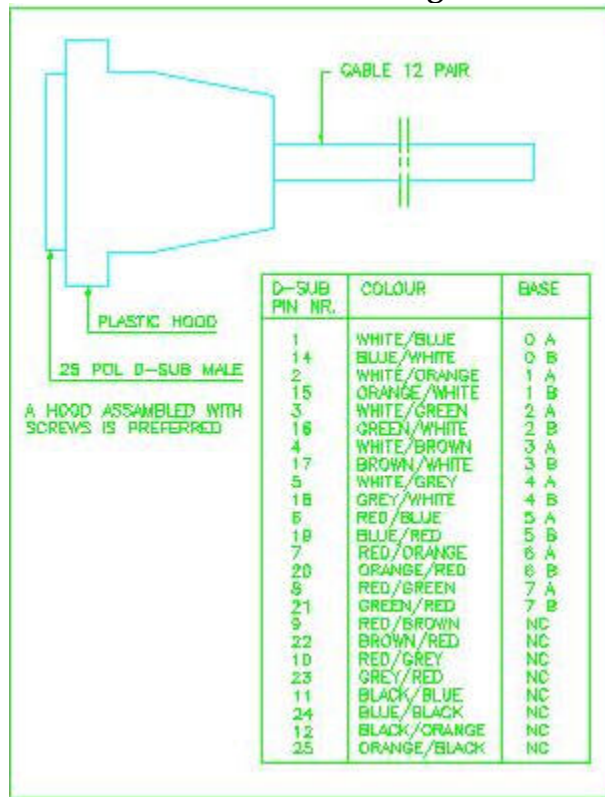

5.7 Base Station and Repeater Installation

Mounting Base Stations

1. Terminate the Base Station cable to a suitable connection point such as a punch-down block or patch panel.
2. Terminate the system end of the twisted-pair cable to a suitable connection point such as a punch-down block or patch panel located close to the termination of the Base Station cable.
3. Cross-connect the Base Station cables to the desired Base Station circuit. Power for the Base Station is provided by the KWS1500 and is delivered via the cable to the Base Station.

After the physical connection is made, the LED in the center of the Base Station will flash. This indicates that the Base Station is receiving power from the KWS1500.

Once the Base Station synchronizes with the KWS1500, the LED will light steady.

4. Base Stations are not polarity sensitive. To mount the Base Station, drill two holes. If mounting to a wooden surface, secure using some suitable screws. If mounting to a brick wall, the holes should be drilled with a 6 mm diameter drill bit. Insert wall plugs, and then secure using two suitable screws.
5. Each Base Station has an RJ-11 four-wire socket located on the base. Crimp an RJ-11 connector to the twisted-pair cable, using the center pair of pins.

6. Connect the cable to the Base Station. It is important to mount the Base Station with the antennas facing out and right-side up.

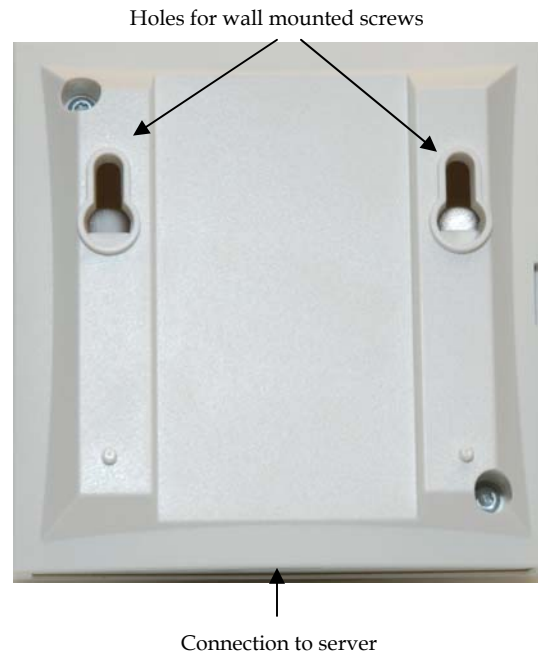

7. The last step is to perform a cable delay measurement using the KWS1500 Administration Software.

The **Cable Delay Measurement** feature can be found on the **Base Station Status** tab located in the **Preferences** screen. The **Preferences** option is located in the **Options** menu. See *KIRK Wireless Server 1500 Administration Program Software Guide*, Section 4.4 *Options – Preferences – Base Station Status*.

Mounting KIRK Repeaters

It is advisable to use the KIRK Service Tool software and configure the Repeater before mounting. Before beginning the installation, determine the position of the repeater for best coverage. The coverage depends on the construction of the building, architecture, and the choice of building materials.



The repeater does not add channels, it only adds additional coverage area.



The repeater can be registered to the solution 1) when placed within the coverage area of a base station, 2) when placed within the coverage area of an already installed repeater or 3) when placed outside the coverage area using an external antenna.



The repeater must not be installed at any angle other than vertical. If the repeater is placed upside-down, the coverage area of the repeater is decreased by 40 – 50%, and it might not transmit or receive effectively.

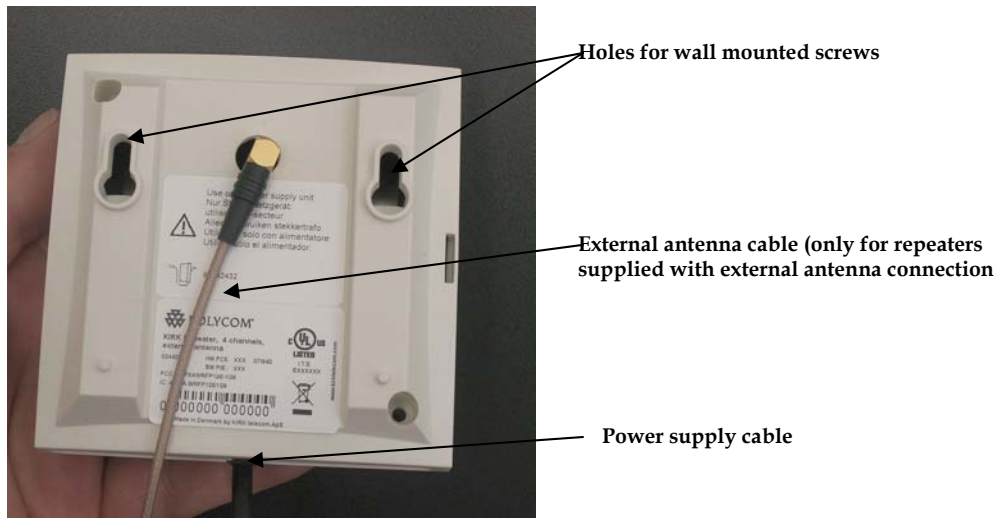

1. Connect the power supply cable into the RJ11 connector in the bottom of the repeater. For repeaters with external antenna, connect the external antenna cable to the antenna connector in the rear of the repeater as well.
2. Mount the repeater onto the wall using the screws accompanying the repeater.

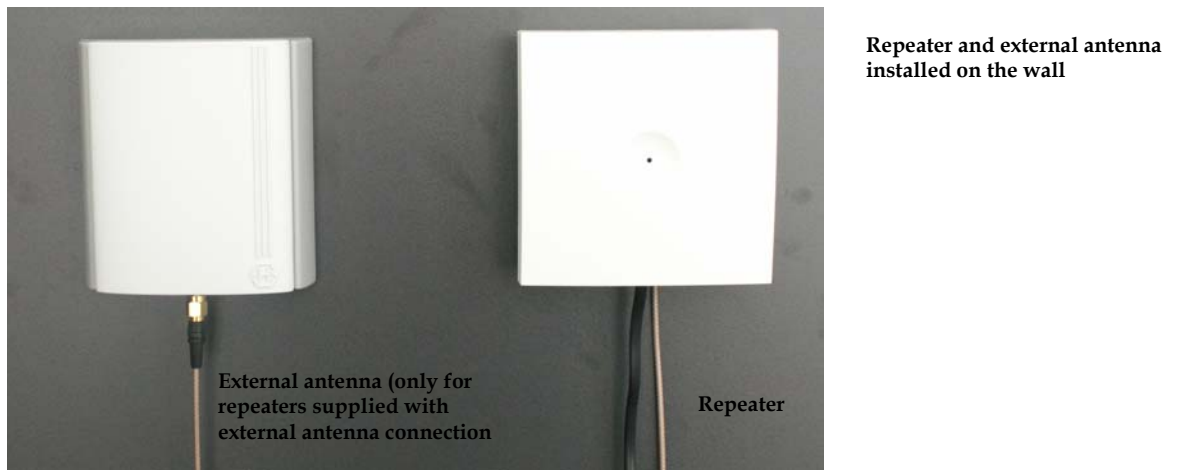

The external antenna used for the transmitter is to be fixed-mounted on indoor permanent structures providing a separation distance of at least 20 cm / 8 inches from all persons during normal operation and must not be co-located or operating in conjunction with any other antenna or transmitter. The maximum radiated output power is 1W e.i.r.p. For more information and technical support, please refer to www.polycom.com

Recording the Installation Information

After completing the installation of the repeaters, record the location of each repeater.

Checking Indicators

Verify the the repeater LED indicator is continuously on, indicating that the repeater is functional.

Power Options

The power supply for the repeater is 9VDC, 300mA.

Base Station and Repeater installation do's and don'ts

Base Stations and Repeaters emit a 1.9 GHz radio signal to support Handsets. In order to receive the best performance from the Base Stations and Repeaters, observe the following rules:

- The KWS1500 Base Station provides a radio coverage radius of around 47 meters / 150 feet indoors, or up to 106 meters / 350 feet outdoors in direct line-of-sight conditions.
- KWS1500 Base Stations should be placed in a central position relative to the expected usage of the handsets. The points following provide guidelines for placement of the Base Station.
- The Base Station and Repeaters are typically wall mounted.
- KIRK Repeaters require local power (standard 120V AC). A dedicated, conditioned power source is recommended.
- The Base Stations and Repeaters **MUST** be placed vertically and right-side up. Placing a Base Station or Repeater in any other fashion can reduce radio signal penetration by up to 50 percent.
- Vertical orientation may be observed by the printed stickers located on the rear of the unit.
- Placing Base Stations or Repeaters above ceilings or ceiling tiles is not recommended.
- Placing Base Stations or Repeaters behind furniture or other objects that may reduce radio signal penetration is not recommended.
- Painting of Base Stations or Repeaters or, if mounted externally, their housing or containers, is not recommended. Paints contain metallic and/or carbon materials that will reduce radio signal penetration.
- Place Base Stations and Repeaters between 1.8 and 2.4 meters / 6 and 8t feet above floor level.
- Do not place Base Stations inside metallic cases. Use plastic enclosures for external mounting.
- Never mount Base Stations or Repeaters to a metallic surface. Metallic surfaces can cause radio signal reflections.

6. Regulatory Notices

CE Mark R& TTE Directive



This KIRK Wireless Server 1500 has been marked with the CE mark. This mark indicates compliance with EEC Directives 89/336/EEC, 73/23/EEC 1999/5/EC. A full copy of the Declaration of Conformity can be obtained from Polycom Ltd, 270 Bath Road, Slough, Berkshire, SL1 4DX, UK.

Česky
[Czech]:

Polycom (UK) Ltd tímto prohlašuje, že tento KIRK *Wireless Server 1500* je ve shodě se základními požadavky a dalšími příslušnými ustanoveními směrnice 1999/5/ES.

Dansk
[Danish]:

Undertegnede Polycom (UK) Ltd erklærer herved, at følgende udstyr KIRK *Wireless Server 1500* overholder de væsentlige krav og øvrige relevante krav i direktiv 1999/5/EF.

Deutsch
[German]:

Hiermit erklärt Polycom (UK) Ltd, dass sich das Gerät KIRK *Wireless Server 1500* in Übereinstimmung mit den grundlegenden Anforderungen und den übrigen einschlägigen Bestimmungen der Richtlinie 1999/5/EG befindet.

Eesti
[Estonian]:

Käesolevaga kinnitab Polycom (UK) Ltd seadme KIRK *Wireless Server 1500* vastavust direktiivi 1999/5/EÜ põhinõuetele ja nimetatud direktiivist tulenevatele teistele asjakohastele sätetele.

English:

Hereby, Polycom (UK) Ltd. declares that this KIRK *Wireless Server 1500* is in compliance with the essential requirements and other relevant provisions of Directive 1999/5/EC.

Español
[Spanish]:

Por medio de la presente Polycom (UK) Ltd declara que el KIRK *Wireless Server 1500* cumple con los requisitos esenciales y cualesquiera otras disposiciones aplicables o exigibles de la Directiva 1999/5/CE.

Ελληνική
[Greek]:

ΜΕ ΤΗΝ ΠΑΡΟΥΣΑ Polycom (UK) Ltd ΔΗΛΩΝΕΙ ΟΤΙ ΚΙΡΚ *Wireless Server 1500* ΣΥΜΜΟΡΦΩΝΕΤΑΙ ΠΡΟΣ ΤΙΣ ΟΥΣΙΩΔΕΙΣ ΑΠΑΙΤΗΣΕΙΣ ΚΑΙ ΤΙΣ ΛΟΙΠΕΣ ΣΧΕΤΙΚΕΣ ΔΙΑΤΑΞΕΙΣ ΤΗΣ ΟΔΗΓΙΑΣ 1999/5/ΕΚ.

Français
[French]:

Par la présente Polycom (UK) Ltd déclare que l'appareil KIRK *Wireless Server 1500* est conforme aux exigences essentielles et aux autres dispositions pertinentes de la directive 1999/5/CE.

Italiano
[Italian]:

Con la presente Polycom (UK) Ltd dichiara che questo KIRK *Wireless Server 1500* è conforme ai requisiti essenziali ed alle altre disposizioni pertinenti stabilite dalla direttiva 1999/5/CE.

Íslenska
(Icelandic):

Hér með lýsir Polycom (UK) Ltd yfir því að KIRK *Wireless Server 1500* er í samræmi við grunnkröfur og aðrar kröfur, sem gerðar eru í tilskipun 1999/5/EC

Latviski
[Latvian]:

Ar šo Polycom (UK) Ltd deklarē, ka KIRK *Wireless Server 1500* atbilst Direktīvas 1999/5/EK būtiskajām prasībām un citiem ar to saistītajiem noteikumiem.

Lietuvių
[Lithuanian]:

Šiuo Polycom (UK) Ltd deklaruoja, kad šis KIRK *Wireless Server 1500* atitinka esminius reikalavimus ir kitas 1999/5/EB Direktyvos nuostatas.

Nederlands [Dutch]:	Hierbij verklaart Polycom (UK) Ltd dat het toestel KIRK <i>Wireless Server 1500</i> in overeenstemming is met de essentiële eisen en de andere relevante bepalingen van richtlijn 1999/5/EG.
Malti [Maltese]:	Hawnhekk, Polycom (UK) Ltd, jiddikjara li dan KIRK <i>Wireless Server 1500</i> jikkonforma mal-htigijiet essenzjali u ma provvedimenti oħrajn relevanti li hemm fid-Dirrettiva 1999/5/EC.
Magyar [Hungarian]:	Alulírott, Polycom (UK) Ltd nyilatkozom, hogy a KIRK <i>Wireless Server 1500</i> megfelel a vonatkozó alapvető követelményeknek és az 1999/5/EC irányelv egyéb előírásainak.
Norsk [Norwegian]:	Polycom (UK) Ltd erklærer herved at utstyret KIRK <i>Wireless Server 1500</i> er i samsvar med de grunnleggende krav og øvrige relevante krav i direktiv 1999/5/EF.
Polski [Polish]:	Niniejszym Polycom (UK) Ltd oświadcza, że KIRK <i>Wireless Server 1500</i> jest zgodne z zasadniczymi wymaganiami oraz innymi stosownymi postanowieniami Dyrektywy 1999/5/WE
Português [Portuguese]:	Polycom (UK) Ltd declara que este KIRK <i>Wireless Server 1500</i> está conforme com os requisitos essenciais e outras disposições da Directiva 1999/5/CE.
Slovensko [Slovenian]:	Polycom (UK) Ltd izjavlja, da je ta KIRK <i>Wireless Server 1500</i> v skladu z bistvenimi zahtevami in ostalimi relevantnimi določili direktive 1999/5/ES.
Slovensky [Slovak]:	Polycom (UK) Ltd týmto vyhlasuje, že KIRK <i>Wireless Server 1500</i> spĺňa základné požiadavky a všetky príslušné ustanovenia Smernice 1999/5/ES.
Suomi [Finnish]:	Polycom (UK) Ltd vakuuttaa täten että KIRK <i>Wireless Server 1500</i> tyyppinen laite on direktiivin 1999/5/EY oleellisten vaatimusten ja sitä koskevien direktiivin muiden ehtojen mukainen.
Svenska [Swedish]:	Härmed intygar Polycom (UK) Ltd att denna KIRK <i>Wireless Server 1500</i> står i överensstämmelse med de väsentliga egenskapskrav och övriga relevanta bestämmelser som framgår av direktiv 1999/5/EG.

Explosive Device Proximity Warning



Warning Do not operate your wireless network device near unshielded blasting caps or in an explosive environment unless the device has been modified to be especially qualified for such use.

Waarschuwing	Gebruik dit draadloos netwerkkapparaat alleen in de buurt van onbeschermde ontstekers of in een omgeving met explosieven indien het apparaat speciaal is aangepast om aan de eisen voor een dergelijk gebruik te voldoen.
Varoitus	Älä käytä johdotonta verkkolaitetta suojaamattomien räjäytysnallien läheisyydessä tai räjäytysalueella, jos laitetta ei ole erityisesti muunneltu sopivaksi sellaiseen käyttöön.oen.
Attention	Ne jamais utiliser un équipement de réseau sans fil à proximité d'un détonateur non blindé ou dans un lieu présentant des risques d'explosion, sauf si l'équipement a été modifié à cet effet.

Warnung	Benutzen Sie Ihr drahtloses Netzwerkgerät nicht in der Nähe ungeschützter Sprengkapseln oder anderer explosiver Stoffe, es sei denn, Ihr Gerät wurde eigens für diesen Gebrauch modifiziert und bestimmt.
Avvertenza	Non utilizzare la periferica di rete senza fili in prossimità di un detonatore non protetto o di esplosivi a meno che la periferica non sia stata modificata a tale proposito.
Advarsel	Ikke bruk den trådløse nettverksenheten nært inntil uisolerte fenghetter eller i et eksplosivt miljø med mindre enheten er modifisert slik at den tåler slik bruk.
Aviso	Não opere o dispositivo de rede sem fios perto de cápsulas explosivas não protegidas ou num ambiente explosivo, a não ser que o dispositivo tenha sido modificado para se qualificar especialmente para essa utilização.
¡Advertencia!	No utilizar un aparato de la red sin cable cerca de un detonador que no esté protegido ni tampoco en un entorno explosivo a menos que el aparato haya sido modificado con ese fin.
Varning!	Använd inte den trådlösa nätverksenheten i närheten av oskyddade tändhättar eller i en explosiv miljö om inte enheten modifierats för att kunna användas i sådana sammanhang.



The WEEE marking on this equipment indicates that the product must not be disposed of with unsorted waste, but must be collected separately.

Appropriate RF safety/installation information

The product is intended to be installed by authorized personal. The product shall be installed in accordance with FCC rules.

RF Exposure Statement

The EUT is considered as a mobile device according to OET Bulletin 65, Edition – 97 – 01. Therefore distance to human body of min. 20 cm is determined.

The internal / external antennas used for this mobile transmitter must provide a separation distance of at least 20 cm from all persons and must not be co-located or operating in conjunction with any other antenna or transmitter.

WARNING

This is a class A product. In a domestic environment this product may cause radio interference in which case the user may be required to take adequate measures. The above warning is inserted for regulatory reasons. If any customer believes that they have an interference problem, either because their Polycom product seems to cause interference or suffers from interference, they should contact their distributor immediately. The distributor will assist with a remedy for any problems and, if necessary, will have full support from Polycom

Safety

WARNING

Only qualified service personnel may install this equipment. The instructions in this manual are intended for use by qualified service personnel only.

Only qualified persons should service the solution.

The installation and service of this hardware is to be performed only by service personnel having appropriate training and experience necessary to be aware of hazards to which they are exposed in performing a task and of measures to minimize the danger to themselves or other persons.

Electrical shock hazards from the telecommunication network and AC mains are possible with this equipment. To minimize risk to service personnel and users, the solution must be connected to an outlet with a third-wire Earth.

Service personnel must be alert to the possibility of high leakage currents becoming available on metal solution surfaces during power line fault events near network lines. These leakage currents normally safely flow to Protective Earth via the power cord. Therefore, it is mandatory that connection to an earthed outlet is performed first and removed last when cabling to the unit. Specifically, operations requiring the unit to be powered down must have the network connections (exchange lines) removed first.

Important Safety Instructions and Product Information

Before using your telephone equipment, you should always follow basic safety instruction to reduce the risk of fire, electrical shock and injury to persons, and damage to property.

1. Read and understand all instructions
2. Follow all warnings and instructions including those marked on the product
3. Unplug this product before cleaning. Do not use liquid cleaners or aerosol cleaners. Use damp cloth for cleaning
4. Do not install the telephone equipment in the bathroom or near a wash bowl, kitchen sink, or laundry tub, in a wet basement, or near a swimming pool
5. The product should be operated only from the type of power source indicated on the instructions. If you are not sure of the type of power supply, consult your dealer or local power company.
6. Do not overload wall outlets and extension cords as this can result in fire or electrical shock.
7. Never push objects of any kind into this product through cabinet slots as they may touch dangerous voltage points or short out parts that could result in fire, electrical shock, or injury. Never spill liquid of any kind into this product.
8. To reduce the risk of electrical shock or burns, do not disassemble this product. Opening or removing covers may expose you to dangerous voltages, dangerous electrical current, or other risks. Incorrect reassemble can cause electrical shock when the appliance is subsequently used. If the product need repair, consult your dealer.
9. If the product uses PoE, the equipment is to be connected only to PoE networks without connection to outside plant
10. Refer servicing to qualified service personnel under the following conditions:

- a. If liquid has been spilled into the product
- b. If the product has been exposed to rain or water
- c. If the product does not operate normally when following the operating instructions in the manual. Adjust only those controls that are covered by the operation instructions. Improper adjustment of other controls may result in damage and will often require extensive work by qualified service personnel to restore the product to normal operation.
- d. If the product has been dropped or cabinet has been damaged
- e. If the product exhibits a distinct change in performance

Warning

1. Avoid using telephone during an electrical storm. There may be a risk of electrical shock from lightning
2. Do not use the telephone to report a gas leak in the vicinity of the leak
3. Do not place the unit near microwave ovens, radio equipment, or non-ground connected televisions. These appliances may cause electrical interference to the base or handset
4. Installation must be performed in accordance with all relevant national wiring rules
5. Plug acts as Disconnect Device - The socket outlet to which this apparatus is connected must be installed near the equipment and must always be readily accessible
6. The solution will not operate in the event of a blackout. Please keep a backup phone for emergencies

Intrinsic safety

Do not install the unit in conditions where there is a danger of electrically ignited explosions.

Exposure to sunlight, heat and moisture

Do not expose the unit to direct sunlight for long periods. Keep away from excessive heat and moisture.

Spare parts and accessories

Use only approved spare parts and accessories. The operation of non-approved parts cannot be guaranteed and may even cause damage.

RF compliance information

The users manual or instruction manual for an intentional or unintentional radiator shall caution the user that changes or modifications not expressly approved by the party responsible for compliance could void the user's authority to operate the equipment.

NOTICES

FCC Note: This device complies with Part 15 of the FCC rules. Operation is subject to the following two conditions: (1) This device may not cause harmful interference, and (2) this device must accept any interference received, including interference that may may cause undesired operation.

IC Note: Operation is subject to the following two conditions: (1) This device may not cause interference, and (2) this device must accept any interference, including interference that may

cause undesired operation of the device. The term "IC:" before the certification / registration number only signifies that the Industry Canada technical specifications were met.

Privacy of communications may not be ensured when using this telephone.

Information to user: The users manual or instruction manual for an intentional or unintentional radiator shall caution the user that changes or modifications not expressly approved by the party responsible for compliance could void the user's authority to operate the equipment.

LIMITED WARRANTY

This limited, non-transferable warranty is provided to the original purchaser. The product is warranted to be free from defects in materials and workmanship under normal installation, use and service for a period of one (1) year from the date of purchase as shown on the purchaser's receipt.

Our obligation under this warranty is limited to repair or replacement (at our option) of the product or any part(s) which are defective provided that the product is returned to the original place of purchase or an authorized service location during the warranty period. Products returned must be accompanied by a copy of the purchase receipt. In the absence of a purchase receipt, the warranty period shall be one (1) year from the date of manufacture. Repair or replacement of the product is your sole and exclusive remedy.

If the product is repaired, reconditioned component parts or materials may be used. If the product is replaced, we may replace it with a new or reconditioned product of the same or similar design. The repaired product will be warranted for either (a) 90 days or (b) the remainder of the original one (1) year warranty period, whichever is longer.

This warranty does not apply to the defects outside of our control, including but not limited to acts of God, fire, flood and damage while in transit to service facility. We do not warrant that the product will be compatible with any telephone equipment, solutions or party lines.

This warranty shall be void if the product is damaged as a result of defacement, misuse, abuse, neglect, accident, destruction or alteration of the serial number, improper electrical voltages or currents, repair, alteration or maintenance by any person or party other than our authorized service facility, or any violation of instructions furnished by us.

This warranty is also void if this product is removed from the country in which it was purchased by the original purchaser, if it is used in a country in which it is not registered for use, or if it is used in a country for which it was not designed. Due to variations in telephone solutions and communications laws, this product may be illegal for use in some countries. We assume no responsibilities for damages or penalties incurred resulting from the use of this product in a manner or location other than that for which it was intended.

THIS LIMITED WARRANTY IS IN LIEU OF ALL OTHER WARRANTIES EXPRESS OR IMPLIED. ANY IMPLIED WARRANTIES INCLUDING BUT NOT LIMITED TO THE IMPLIED WARRANTIES OF MERCHANTABILITY AND FITNESS FOR A PARTICULAR PURPOSE, SHALL BE LIMITED TO THE DURATION OF THIS WRITTEN LIMITED WARRANTY. WE DISCLAIM ANY LIABILITY FOR DAMAGES FOR LOSS OF USE OF THE PRODUCTS, LOSS OF TIME, INCONVENIENCE, INJURY TO ANY PERSON, OR DAMAGE TO PROPERTY CAUSED BY THE PRODUCT, LOSS OF REVENUE OR PROFIT OR DAMAGES FOR ANY FAILURE TO PERFORM. IN NO EVENT SHALL WE BE LIABLE FOR ANY SPECIAL, INCIDENTAL, PUNITIVE OR CONSEQUENTIAL DAMAGES EVEN IF WE ARE ADVISED OF THE POSSIBILITY OF SUCH DAMAGES.

Some states do not allow limitations on how long an implied warranty lasts, so the above limitations may not apply to you. This warranty is the sole and exclusive warranty provided for

the product. There are no other express warranties. This warranty gives you specific legal rights, and you may also have other rights, which vary from state to state.

Index

- Accessories
 - Deployment/Demonstration Kit, 29
 - Handset Belt Clip, 30
 - Handset Case, 29
 - Handset Charger, 29
 - Handset Programming Kit, 29
 - Handset Safety Line, 29
 - Headset, 29
- Administration Program, 30
- Analog Interface card
 - Installation, 36
 - Supports up to 8 analog lines, 36
- Base Stations, 5, 20
 - Antennas, 20
 - Coverage radius, 20
 - Indoor/outdoor installation, 21
 - Installation do's and don'ts, 42
 - Maximum repeaters per, 22
 - Mounting, 38
 - Number of calls supported, 20
 - Power wiring, 20
 - Specifications, 21
 - Wiring, 37
- Expansion card
 - Installation, 35
- Handset, 5
 - Activating the signal meter, 17
 - Handset Belt Clip, 30
 - Handset Case, 29
 - Handset Safety Line, 29
 - Handsets supported on the KWS1500, 24
 - Headset, 29
 - IPEI (serial) number, 6
 - Programming Kit, 29
- Installation, 33
 - Analog Interface cards, 36
 - Base Station and Repeater do's and don'ts, 42
 - Base Stations, 21, 38
 - Expansion card, 35
 - Repeaters, 40
- Internal hardware
 - Analog Interface card, 28
 - Construction, 33
 - Expansion card, 27
 - Expansion modules, 25
 - Installation, 32
 - Tools required, 32
- KWS1500 Solution
 - Accessories, 29
 - Analog Interface card installation, 36
 - Analog Interface cards, 28
 - ARI number, 6
- Base Stations, 5
 - Expansion card, 35
 - Expansion card, 27
 - Handsets, 5
 - Installation, 33
 - Interior, 34
 - Internal hardware, 25
 - Internal hardware installation, 32
 - Overview, 5
 - Programming Tools, 30
 - Radio hardware, 20
 - Repeaters, 5
 - Specifications, 26
 - Supports 32 Base Stations, 8
 - Supports 64 Handsets, 8
- Programming tools
 - Administration Program, 30
 - Handset Programming Kit, 29
 - Programming cables, 30
 - Service cables, 30
 - Service Tool, 30
- Radio coverage
 - Areas, 8
 - Hot spots, 14
 - Measurement values, 15
 - Overlap, 11
 - Planning, 8
 - Q-value, 15
 - Radius, 8
 - RSSI value, 16
 - Seasons, 15
 - Shadows, 15
 - Weather conditions, 15
- Radio hardware
 - Base Stations, 20
 - Handsets, 24
 - Repeaters, 22
- Repeaters, 5
 - Antennas, 22
 - Configurations, 22
 - Do not increase number of active voice channels, 22
 - Installation do's and don'ts, 42
 - Jump configuration, 23
 - Maximum, per Base Station, 22
 - Minimum Base Station RSSI value, 22
 - Mounting, 40
 - Multi-cell environment, 23
 - Specifications, 23
- Signal meter
 - Base Station hexadecimal numbering, 19
 - Display, 18
 - Performing measurements, 17

Free Manuals Download Website

<http://myh66.com>

<http://usermanuals.us>

<http://www.somanuals.com>

<http://www.4manuals.cc>

<http://www.manual-lib.com>

<http://www.404manual.com>

<http://www.luxmanual.com>

<http://aubethermostatmanual.com>

Golf course search by state

<http://golfingnear.com>

Email search by domain

<http://emailbydomain.com>

Auto manuals search

<http://auto.somanuals.com>

TV manuals search

<http://tv.somanuals.com>