



NetLink e340/h340/i640 Wireless Telephone and Accessories

NetLink s340 Docking Station

NetLink s640 Docking Station

NetLink Desktop Charger

NetLink Dual Charger

NetLink Quad Charger

User Guide

SpectraLink Radio Protocol (SRP)

Cisco SCCP Protocol

ITU H.323 Protocol

Mitel MINET Protocol

SIP Protocol

Part Number: 72-1004-01
Issue J

Trademark Information

Polycom® and the logo designs
SpectraLink®
LinkPlus
Link
NetLink
SVP

Are trademarks and registered trademarks of Polycom, Inc. in the United States of America and various countries. All other trademarks used herein are the property of their respective owners.

Patent Information

The accompanying product is protected by one or more US and foreign patents and/or pending patent applications held by Polycom, Inc.

Copyright Notice

Copyright © 2005 to 2008 Polycom, Inc.

All rights reserved under the International and pan-American copyright Conventions.

No part of this manual, or the software described herein, may be reproduced or transmitted in any form or by any means, or translated into another language or format, in whole or in part, without the express written permission of Polycom, Inc.

Do not remove (or allow any third party to remove) any product identification, copyright or other notices.

Every effort has been made to ensure that the information in this document is accurate. Polycom, Inc. is not responsible for printing or clerical errors. Information in this document is subject to change without notice and does not represent a commitment on the part of Polycom, Inc.

Notice

Polycom, Inc. has prepared this document for use by Polycom personnel and customers. The drawings and specifications contained herein are the property of Polycom and shall be neither reproduced in whole or in part without the prior written approval of Polycom, nor be implied to grant any license to make, use, or sell equipment manufactured in accordance herewith.

Polycom reserves the right to make changes in specifications and other information contained in this document without prior notice, and the reader should in all cases consult Polycom to determine whether any such changes have been made.

No representation or other affirmation of fact contained in this document including but not limited to statements regarding capacity, response-time performance, suitability for use, or performance of products described herein shall be deemed to be a warranty by Polycom for any purpose, or give rise to any liability of Polycom whatsoever.

Contact Information

Please contact your Polycom Authorized Reseller for assistance.

Polycom, Inc.
4750 Willow Road,
Pleasanton, CA 94588
<http://www.polycom.com>

Table of Contents

The NetLink e340 Wireless Telephone	4
The NetLink h340 Wireless Telephone	5
The NetLink i640 Wireless Telephone	6
Operating Instructions	7
Status Indicators	7
Modes of Operation	8
Basic Operation	9
The Wireless Telephone Headset	10
System Feature Activation	11
Using the Softkeys	12
Setting User Preferences	13
Navigation	14
Lock keys	14
Ring options	14
Phone options	15
System info	15
Extension	16
Push-to-talk (PTT)	16
Push-to-talk operation	16
NetLink e340/h340/i640 Wireless Telephone Accessories	19
The NetLink Docking Station	19
Battery Packs	27
NetLink Desktop Chargers	29
NetLink Dual Chargers	30
NetLink Quad Chargers	32
Important Notes about Chargers and Battery Packs	34
General Care of the Handsets and Chargers	35
Tips for Use	36
PLEASE NOTE:	36
Appendix A: Cisco SCCP Protocol	37
Overview	37
Feature Access	38
Appendix B: ITU H.323 Protocol	40
Overview	40
Feature Access	40
Appendix C: Mitel Networks	42
Overview	42
Feature Access	44
Appendix D: SIP (Session Initiation Protocol)	45
Overview	45
Basic Operation	46
Safety and Regulatory Information	48
NOTE CONCERNING THE WIRELESS TELEPHONES	48
OPERATIONAL WARNINGS	48
ELECTRO MAGNETIC INTERFERENCE/COMPATIBILITY	49
SPECIFIC ABSORPTION RATE (SAR) INFORMATION	50

The NetLink e340 Wireless Telephone

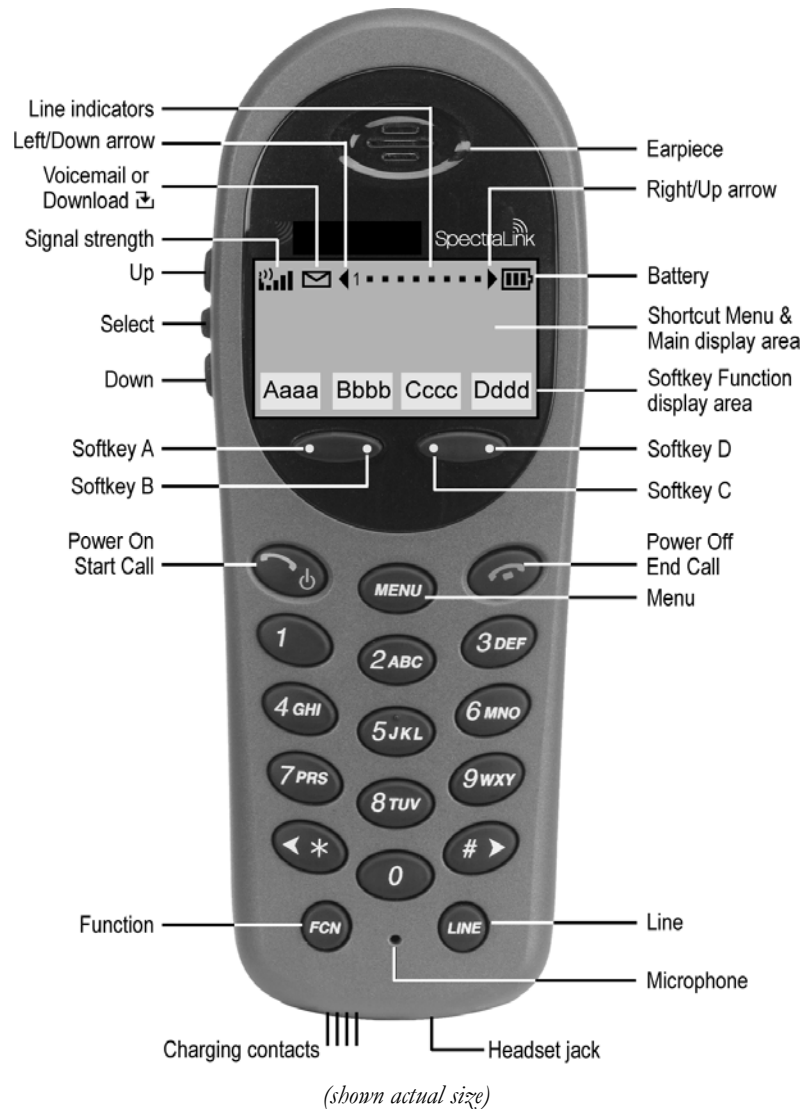

The NetLink e340 Wireless Telephone supports a broad range of enterprise applications and is ideally suited for the general office, finance or hospitality environments. This compact handset offers a rich set of features including a high-resolution graphic display, menu-driven functions and messaging capability – all within a lightweight ergonomic design. A full set of accessories is available including headsets, chargers and carrying cases.

The NetLink h340 Wireless Telephone



(shown actual size)

The NetLink h340 Wireless Telephone is a more durable version of the NetLink e340 Wireless Telephone and is ideally suited for healthcare environments. The handset offers the same features as the NetLink e340 Wireless Telephone including optional interfacing to nurse call systems and other applications commonly used in healthcare environments. A full set of accessories is available including headsets, chargers and carrying cases.

The NetLink i640 Wireless Telephone

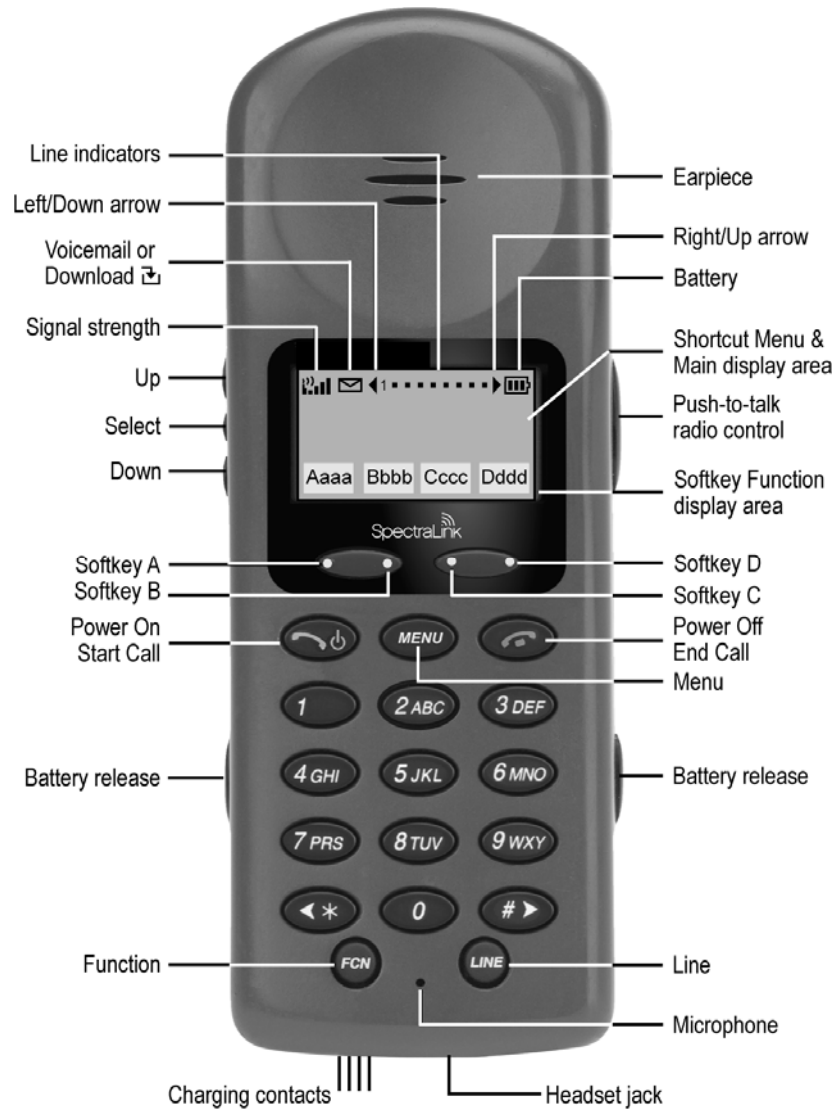

(shown actual size)





The NetLink i640 Wireless Telephone is the industry's most durable handset for workplace applications. All features available on the NetLink e340 Wireless Telephone are included. Push-to-talk functionality is also available for broadcast communication among personnel, eliminating the need for two-way radios or walkie-talkies. The large earpiece seals out background noise and provides comfort for frequent or long calls. A full set of accessories is available including headsets, chargers and carrying cases.

Operating Instructions

Your NetLink Wireless Telephone is a state of the art communication device that utilizes radio wave technology to send and receive voice transmissions. It is designed to operate like the familiar cell phone. However, the handset utilizes the private telephone system installed in your facility and will not operate outside the area reached by this system. Additionally, the features that are available depend on how the handset has been programmed by your system administrator.

The following guide is meant to provide general information about your handset. Contact your system administrator for additional information on how your handset functions within your telephone system.

Status Indicators

- 1 ••••••••** The line indicators are associated with line access keys. In the preceding diagram, line 1 is active.
 - ◀ ▶** A left or right arrow is displayed when the screen can be toggled either left or right to display more characters as described above.
 - ▲ ▼** Up and down arrows are displayed when the menu has additional options above or below what is shown in the display area.
 - ** The battery icon indicates the amount of charge remaining in the Battery Pack. The level indications are approximations of the remaining Battery Pack life. They do not indicate equal amounts of Battery Pack Life. When only one level remains, the Battery Pack needs to be charged.
 - ** The Voicemail icon is activated when a new voice mail message is received if the feature is supported by the phone emulation. It appears to the right of the Signal Strength icon.
 - Battery Low** This message displays and an alarm sounds when the handset is in standby mode and the Battery Pack is critically low. The handset cannot be used until the Battery Pack is charged.
 - [No Service message]** If warning tones are not disabled, an alarm will sound and a descriptive message displays when the handset cannot receive or place calls. You may be outside of the covered area. Walk back into the covered area. The in-service tone indicates service is re-established.
 - ** The signal strength icon indicates the strength of the signal and can assist the user in determining if the handset is moving out of range.
 - ** The download icon indicates that the handset is downloading code. This icon only appears while the handset is running the over-the-air downloader. It appears to the right of the Signal Strength icon in the same location as the Voicemail icon.
 - [Melody]** A melody is played after the handset is powered on for the first time following a completed charge (Charge Complete).
-

Modes of Operation

The handset uses different amounts of power and bandwidth in different modes of operation. Bandwidth is provided by access points located throughout your facility. Bandwidth availability varies by type of access point. The Battery Pack in your handset provides about four hours of talk time or 80 hours in the Standby mode (see below).

If push-to-talk (NetLink i640 Wireless Telephone only) is allowed in the Admin menu and enabled by the user, standby Battery Pack life is decreased to about 30 hours.

Conservation of battery life and bandwidth is possible when you understand the modes and use them appropriately.

Standby mode

In the standby mode the handset is waiting for an incoming call or for the user to place an outgoing call. The extension number is shown on the display and there is no dial tone. In this mode, the handset is conserving battery power and bandwidth.

You may set certain preferences in the user option menu described later. This menu is accessed from the standby mode.

It is important to return to the standby mode after finishing a call by pressing the **End Call** key. Unless otherwise directed, the following instructions for using the handset assume that it is in Standby mode.

Active mode

To place a call, press the **Start Call** key. This transitions the handset to active off-hook mode. There is a dial tone, the handset is in communication with the PBX, and the display shows information as it is received from the PBX.

The handset is also in the active mode when you receive a call.

In certain PBX integrations, some features are designed to be accessed from an active on-hook mode. To go on-hook while still active, you may be directed to press the **Line** key or a Release feature key.

See the Appendices for information about on-hook dialing (cell phone dialing).

Whenever you are in active mode, whether off-hook or not, the handset requires the most bandwidth of any mode.

To conserve bandwidth and battery power, when you have completed a call or are finished accessing active mode menus and features, press the **End Call** key to exit the active mode and return to the standby mode.

Push-to-talk mode (NetLink i640 Wireless Telephone only)

The push-to-talk mode utilizes a common channel for incoming and outgoing radio communication. Outgoing communication uses the same amount of bandwidth as the off-hook mode. Incoming communication uses about half as much.

Basic Operation

Turn the handset on	Press and hold the Power On key for about one second, until two chirps sound. Release the key. The in-service tone sounds and the extension number displays. The handset is now in standby mode, ready to make and receive calls.
Turn the handset off	While in standby mode, press and hold the Power Off key. One chirp sounds and the handset turns off. The handset cannot be directly turned off during a call. End the call first and then turn the handset off.
Make a call or go off hook	Press the Start Call key and then dial the number.
Select a line	If multiple lines are available, your telephone system may require you to select a line before dialing a number. Press the LINE key and the number key of the line you wish to use. You may hear a dial tone.
Dial a number	Dial calls with the handset exactly as with your desk phone. You may dial extension numbers, internal numbers, or make external calls, depending on the setup of your PBX. You may hear a dial tone, then press the number keys to dial the number.
Answer a call	<p>The handset will ring or vibrate to alert you to an incoming call. Additionally, a line number on the display may flash, and the display may show information about the call, such as caller's name and extension.</p> <p>To answer a call, press the Start Call key, hold the earpiece to your ear and speak with a normal tone of voice.</p> <p>If you are on a call and hear subdued ringing, a call is coming in on a second line. The line number on the display may be flashing. To answer this call, put your first call on hold and press the LINE key, then press the line number of the second call.</p>
Headset answer	When a headset is plugged into the handset, the Start Call, 0 - 9, * or # key may be pressed to answer a call.
Hang up	To hang up, press the End Call key. Be sure to do this at the end of each call.
Unlock Keypad	Press the Unlk softkey, then # , to unlock the keypad.
Lock Keypad	Press FCN , then Select , to activate Lock Keys on the Standby Menu.
Change speaker volume	You may increase or decrease the volume of the speaker while in a call by pressing the corresponding Up and Down buttons located on the left side of the handset.
Change ring volume	You may increase or decrease the ring volume on the NetLink i640 Wireless Telephone by pressing the corresponding Up and Down buttons located on the left side of the handset while it is ringing.
Silence while ringing	You may silence a ringing handset by pressing the End Call button. This action does not interrupt the call and the caller may leave a voicemail message.
Backlight	The backlight comes on when any key is pressed or when there is an incoming call and stays on for ten seconds. It turns off after ten seconds if another key is not pressed within that period.

The Wireless Telephone Headset

SpectraLink offers optional headsets for use in noisy environments or if you need to have your hands free while talking on the handset. To use the headset, simply plug it into the jack on the bottom of the handset.

While using a headset, the handset will only ring externally for NetLink e340/h340 Wireless Telephone models. There is no internal headset ring for these models.

The NetLink i640 Wireless Telephone does have an internal headset ring. An incoming call will ring in the earpiece. The handset will also ring externally.

The headsets offered by SpectraLink are specially designed to work properly with the NetLink Wireless Telephone. We do not recommend using other headsets.

System Feature Activation

The features that have been programmed in your system may be viewed and activated through the Shortcut Menu and Softkey Functions. See the Appendices for variations when protocols other than SRP are used.

View Shortcut menu* System features that are accessible by the NetLink Wireless Telephone may be viewed by going off hook (pressing the **Start Call** key) and then pressing the **MENU** key. A feature menu displays in the Main display area. This is the Shortcut Menu.

The Shortcut Menu lists the feature shortcut, if any, and the feature description. As you scroll through the features by pressing the **Up** and **Down** buttons, the feature abbreviation is highlighted in the softkey function display area. To activate a feature, you may press its softkey, its shortcut key, or the **Select** button while the option is highlighted.

Using the Select button To use the **Select** key, press **Up** or **Down** to highlight an option, then press **Select** to activate the feature.

Using the Shortcut keys Programmed features may have the number 1-9, *, 0, or # in the left column of the Shortcut Menu. This designates the shortcut key that activates that feature. To activate the feature using its shortcut key, press the shortcut key at any time while in the Shortcut Menu. The feature will activate whether or not that feature is currently displayed or highlighted. No shortcut indicates that the feature does not have a shortcut and this is generally the case with primary level softkey functions.

Example: If the Transfer feature is programmed to shortcut key 2, the Shortcut Menu will display

2 Transfer

When the Transfer option is highlighted in the menu, **Xfr** will be highlighted in the softkey function display area.

To activate the Transfer feature, press **2**.

You may also press the corresponding softkey.

Alternately, you may scroll to the option and press **Select**.

If you are not already scrolling through the Shortcut Menu, simply press **MENU + 2** to activate the Transfer feature.

* See the Appendices for variations when protocols other than SRP are used.

Using the Softkeys

The softkeys on your NetLink Wireless Telephone enable you to quickly activate system features. There are four softkeys and up to 16 features programmed for softkey access. See the Appendices for variations when protocols other than SRP are used. The display area directly above each softkey is programmed with a feature abbreviation to guide your access to the feature. The softkeys are referred to from left to right as A,B,C,D. In our diagram, the corresponding display area is labeled Aaaa, Bbbb, Cccc, Dddd.

The softkeys operate with a toggle function. Press the left or right side of the key to activate the corresponding softkey feature.

View Softkey functions

The first four primary softkey features are displayed in the softkey function display area by default. To view all of the features that can be activated through the softkeys, go off hook (briefly press the **Start Call** key) and then press the **FCN** key. The second set of feature abbreviations will display in the softkey display area. Each time the **FCN** key is pressed, a different set of features is displayed, until all 16 possible features have been displayed. The softkey features display in the same sequence as they appear on the Shortcut Menu.

Activate any feature while its abbreviation is displayed by pressing the corresponding softkey.

Using the Shortcut keys

While scrolling through the softkey functions, a shortcut key may be pressed to activate its corresponding feature, whether or not that feature is currently displayed in the softkey function display area.

Because system features vary, your system administrator will explain them in reference to your telephone system.

Example:

Using the previous example for the Transfer function: If the Transfer function is assigned to softkey A in the second level row, then **Xfr** will display in the **Aaaa** softkey display area when the **FCN** key is pressed. Therefore, while in a call press **FCN** + (softkey **A**) to transfer the call.

Alternately, you may use the shortcut key by pressing **FCN** + **2**. You may also press **MENU** + **2** as described in the Shortcut Menu section above.

Note:

PBX systems function differently. If your handset does not conform to these instructions, contact your system administrator for function clarification.

* See the Appendices for variations when protocols other than SRP are used.

Setting User Preferences

When the handset is in standby mode (on but not in use), press and briefly hold **FCN** to display the Standby menu which allows you to set user options. Check with your system administrator for specific features supported by your handset.

Standby menu item	2 nd Level	3 rd Level	4 th Level
Lock Keys			
Language	[List per download]		
Ring Options	Telephone Ring	Ring Cadence	Off *PBX Continuous Short Pulse Long Pulse
		Ring Tone	*Tone 1 Tone 2 Tone 3 Tone 4 Tone 5
		Ring Volume+	Bars
		Vibrate Cadence	*Off PBX Continuous Short Pulse Long Pulse
		Ring Delay**	*No Delay 5 Second Delay 10 Second Delay
		Auxiliary Ring 1 Auxiliary Ring 2	
Phone Options	Noise Mode	*Normal High Severe	
	Key Tones	*Enable Tones Disable Tones	
	Warning Tones	*Enable warnings Disable warnings	
	Display Contrast	Contrast %	
	Keypad Autolock	*Disable 5 seconds 10 seconds 20 seconds	
System Info	Phone IP Addr		
	Gateway IP Addr		
	Firmware Version		
Extension			
Push-to-talk+	Channel	Current Channel: X 1 2 3 4 5 6 7 8 New Channel = ?	
		Enable/Disable	PTT Enabled *PTT Disabled
	Audio Volume	Bars	
	Tone Volume	Bars	

* Default setting

**shows up when Ring Cadence and Vibrate Cadence are both set to a value other than "Off"

+ These options are available only on the NetLink i640 Wireless Telephone

Navigation

- Up/Down** buttons: display previous/next menu item.
- Select** button: selects the menu item or option.
- OK** softkey: selects the menu item or option.
- Save** softkey: saves the entry.
- Bksp** softkey: backspaces to allow editing of entry.
- Cncl** softkey: cancels edit and returns to previous menu level.
- Up** softkey: returns to previous menu level.
- Exit** softkey: exits the menu (at the top level).
- End Call** key: exits to standby state (from any level)

Lock keys

Locks/unlocks the keypad. When enabled, the Keypad Lock option will lock the keypad immediately. If the keypad is locked, it may be unlocked by the end user pressing the Unlk softkey and then the # key.

Ring options

- Allows the user to set the ring for three separate functions. **Telephone Ring** is used for usual telephony functions. The **Auxiliary Rings** may be used to set ringing patterns for OAI applications.
- Telephone ring** Allows the user to set a distinctive ring style, volume and sequence. Select from an audible ring or a vibrate-only ring or a vibrate ring along with or followed by an audible ring.
- Ring cadence** The cadence is the rhythm of the ring. It may be set to a pre-programmed ring cadence or it may be set to obtain its cadence from the PBX. The **PBX** option is designed to utilize any distinctive rings sent by the PBX while allowing the user to set unique rings for auxiliary applications.
- Off:** silent
- PBX:** PBX determines ring cadence (e.g. the PBX may send rings that differentiate between internal and external calls.)
- Continuous:** rings continually until answered
- Short Pulse:** rings in short bursts
- Long Pulse:** rings in long bursts
- Ring tone** The **Play** softkey allows the user to preview the tone before selecting. If Ring Cadence is turned off, the Ring Tone option will not appear on the menu. Select from five available tones (scroll to **Tone 5** option).
- Ring volume** (NetLink i640 Wireless Telephone only) The graduated volume bar indicates the levels. This setting may be overridden by adjusting volume while the handset is ringing. Select a volume level by pressing the **Up** and **Down** side buttons and then pressing the **OK** softkey. If Ring Cadence is turned off, the Ring Volume option will not display.
- Vibrate cadence** The Vibrate cadence options are the same as for Ring Cadence.

Ring delay	Determines how long the vibrate cadence will play before the audible ring starts. If the Ring Cadence or Vibrate Cadence is turned off, the Ring Delay option will not appear on the menu. Select the desired length of Ring Delay: No delay: the audible ring starts as soon as the handset starts to vibrate. 5 second delay: the handset vibrates for five seconds before the audible ring starts. 10 second delay: the handset vibrates for ten seconds before the audible ring starts.
Auxiliary ring 1	Designed to be utilized by OAI applications, enabling the user to set a distinctive ring for these applications. Select the desired Auxiliary Ring
Auxiliary ring 2	

Phone options

Noise mode	Provides options that describe the noise level in your environment. Selecting the correct option will adjust the handset to account for background noise. Select Normal for most office environments; High for moderate background noise; or Severe for extremely noisy conditions. Use of the non-Normal modes is not recommended unless you are in a loud environment or you may find it difficult to be heard on your handset.
Key tones	Determine if tones play when keys are pressed. Key tones are enabled by default. Turn key tones on or off.
Warning tones:	Play to alert user to various conditions, such as system up or down, out of range, etc. These tones are enabled by default. Turn warning tones on or off.
Display contrast	Adjusts the display for different lighting situations. Set contrast by pressing the Up and Down side buttons until the desired contrast is displayed and then pressing the OK softkey.
Keypad autolock	Locks the keypad automatically when in standby mode. The automatic locking function of the keypad may be disabled (the default) or adjusted for a delay before locking. Select desired keypad autolock delay: Disable: the keypad will not lock. 5 seconds: the keypad will lock in five seconds 10 seconds: the keypad will lock in ten seconds 20 seconds: the keypad will lock in 20 seconds

System info

Phone IP address	Displays the IP address currently assigned to the handset. This number may not be edited.
Gateway IP address or Server IP address	Displays the IP address currently assigned to the NetLink Telephony Gateway (in SRP) or the SVP Server IP (in other protocols—see appendices).
Firmware version	Displays the software version running the handset.

Extension

Displays the extension currently assigned to the handset. This number is for display purposes only; entering it does not assign the extension in the host telephone system.

Push-to-talk (PTT)

The NetLink i640 Wireless Telephone incorporates push-to-talk functionality. PTT may be allowed or disallowed in the Admin menu. If allowed, the user may enable or disable locally, and may set the channel, tone volume and audio volume. The menu for push-to-talk does not appear if PTT is disallowed on the Admin menu or if no channel is enabled on the Admin menu.

Channel

The current channel is displayed. The user may enable any PTT channel that has been allowed in the Admin menu by entering the corresponding number from the keypad. If PTT has been enabled in this handset, the default channel is the lowest allowed channel as set in the Admin menu.

Enable/Disable

Enable turns on PTT mode. Disable turns off PTT mode. PTT is disabled by default.



If PTT is allowed in the Admin menu and enabled by the user, standby Battery Pack life is decreased to about 30 hours.

Audio volume Tone volume

Used to adjust volume of PTT audio and tones. The graduated volume bar indicates the levels. The Audio Volume setting may be overridden by adjusting volume while the handset is in a push-to-talk call. Select a volume level by pressing the Up and Down side buttons and then pressing the OK softkey.

(Additional options may be present. Contact your system administrator for information.)

Push-to-talk operation

Overview

The push-to-talk feature allows NetLink i640 Wireless Telephones to operate in a push-to-talk (PTT) group broadcast mode in addition to the standard telephone operation.

The NetLink i640 Wireless Telephone supports eight multicast channels with the current channel saved in memory on the handset. A PTT call is initiated by pressing the **Talk** button located on the right side of the handset. All NetLink i640 Wireless Telephones that are monitoring that channel will hear the transmission.

PTT dialogue is interrupted when you answer a PBX call. When the PBX call is ended, PTT dialogue resumes if in an active call.

Selecting a channel

See *Setting User Preferences* above.

Call period

The two-way radio operates on the concept of a push-to-talk session or call period. The push-to-talk call period begins with the first transmission and ends when there has been no two-way radio traffic on the channel for ten seconds.

The PTT mode controls the keypad during a push-to-talk call period. Therefore it is not possible to use the keypad for any other function such as accessing the on-hook menus or accessing an OAI application unless the PTT call is Terminated (see below). However, it is possible to easily place a PBX call (see below).

- Initiating a call** Press the **Talk** button and wait briefly to activate the channel before talking. You may begin talking when the display shows **Transmitting**.
- Transmitting** Once a call has been initiated, hold the handset two inches from your mouth and talk into the microphone. When the **Talk** button is released, the NetLink i640 Wireless Telephone then enters the waiting state where it monitors the channel for up to ten seconds. Initiate subsequent transmissions by pressing the **Talk** button on any NetLink i640 Wireless Telephone using the same channel. The user can start talking immediately. The display screen shows the current active channel.
- If no transmission occurs during the ten-second countdown period, the NetLink i640 Wireless Telephone reverts to the idle state.
- Receiving** Upon receiving a PTT transmission, the handset plays the “receiving alert” sound and enters the receive state.
- In this state the handset receives all conversations on the selected channel. The handset will ignore the **Talk** button while in the receive state. The screen shows the current active channel, the caller ID information of the current transmitter, and an indication that the handset is receiving a broadcast transmission. The caller ID is protocol specific. In most cases it is simply the extension number programmed in the handset from the on-hook user menu.
- At the end of a transmission, the handset enters the waiting state where it monitors the channel for up to ten seconds and displays “Waiting” on the screen. If no other transmission occurs within ten seconds the handset reverts to idle state.
- Change PTT volume** Use the **Up** and **Down** buttons to raise or lower PTT volume. A separate volume is maintained for PTT calls with the current volume selection retained in memory.
- Muting a PTT call** To mute a current call, press the **Mute** soft key. This brings up a **Mute Two-Way Radio?** prompt. Press the **Yes** or **No** soft key. The prompt disappears after three seconds if the user doesn’t confirm either **Yes** or **No**.
- Mute only affects the current call and the handset will play subsequent PTT calls. Mute does not allow the user to use the handset’s keypad for anything else, including an OAI application. The **Mute** soft key turns into an **Unmute** soft key while in the mute state and can be used to unmute the PTT call (the confirmation prompt is displayed first).
- When the next PTT call period starts the audio is automatically unmuted.
- Early termination of a PTT call** In order to terminate incoming broadcasts, press the Terminate soft key and answer Yes to the confirmation prompt. Push-to-talk audio is immediately stopped and the handset exits the PTT session. No other handset is affected. Only the current call is terminated for this handset. When the next PTT call period starts, the handset is again in the receive state. You may rejoin a still-active session by initiating a PTT call.
- Users should disable the PTT feature in the on-hook user menu if it is desired to not receive any further PTT calls.

- Incoming PBX call during a PTT call** A telephone call may be answered while in a PTT call session. To announce an incoming call, the handset will ring with a low-volume ring and display the system message.
To answer the call, press **Start Call**. The PTT call session will be pre-empted and no PTT audio will be heard.
After the PBX call is over, press **End Call** as usual to go back on hook, at which time PTT goes out of pre-empted mode and becomes active again. If an already active PTT call has not ended, the PTT audio starts playing again.
If the user does not answer the telephone call by pressing **Start Call**, the PTT display will be shown after the ring has stopped.
- Making a PBX call during a PTT call** To start a telephone call during a PTT call session, press the **Start Call** key. This causes the two-way radio to be pre-empted as described above.
- Incoming PTT call during a PBX call** The PTT “receiving alert” sound will play softly in the speaker audio, if a PTT session is started during a PBX call. You may continue your PBX call normally, or you may switch to the PTT call by ending the PBX call by pressing the End Call button.
-

NetLink e340/h340/i640 Wireless Telephone Accessories

The NetLink Docking Station

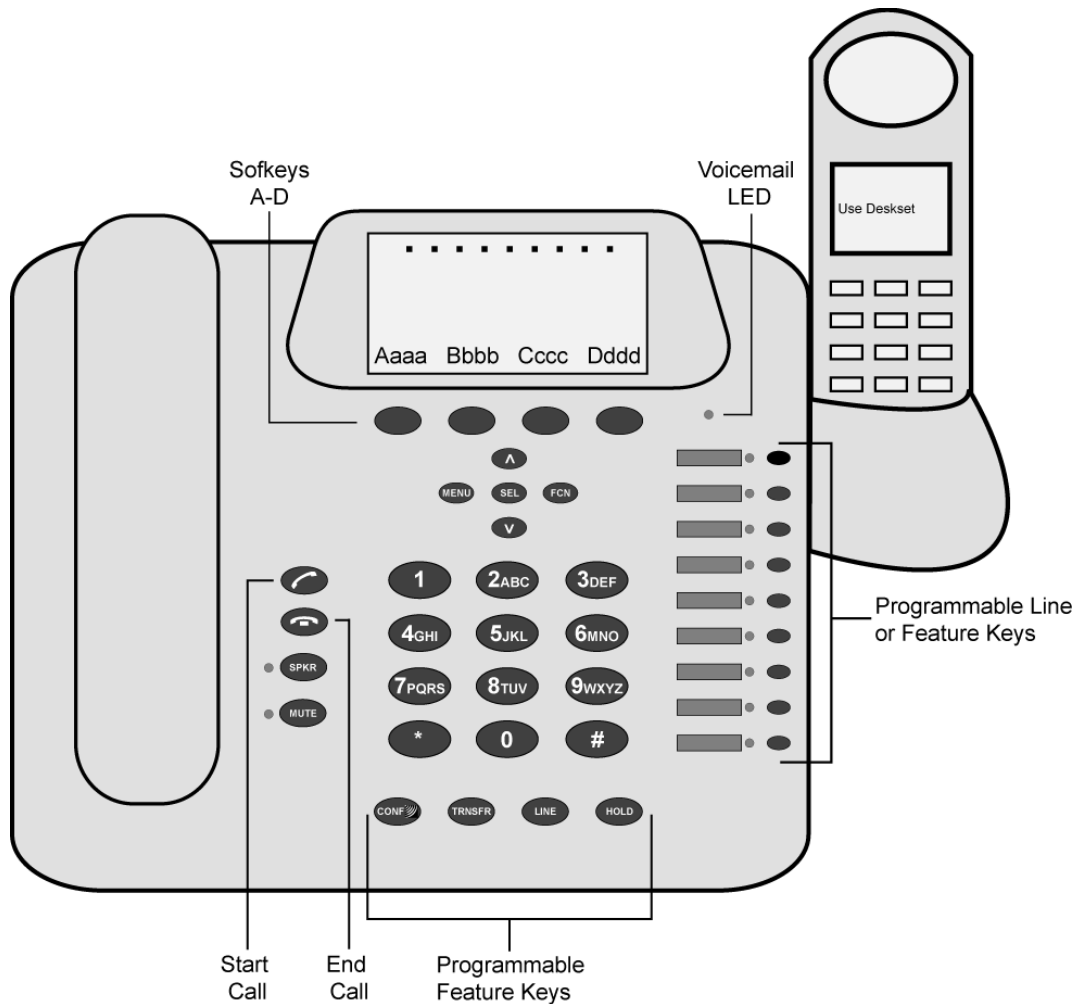

The NetLink s340/s640 Docking Stations are complementary to SpectraLink's existing handsets in a NetLink Gateway system using SRP. The Docking Stations provide the convenience of a desktop telephone set when docked with the existing NetLink e340, h340 or i640 Wireless Telephone. These desktop telephones are designed for the worker that splits time between a desk location and wireless roaming throughout the workplace.

The Docking Stations are available only in an SRP environment; they do not function with any other protocol.



Only the SRP protocol used with the NetLink Telephony Gateway is supported on the NetLink Docking Station.

Overview

The NetLink s340 Docking Station and NetLink s640 Docking Station add desktop functionality to the portable NetLink e340, h340 and i640 Wireless Telephones. The NetLink Docking Stations are designed for use by workers who require both mobile telephony functions and the convenience of a deskset in a fixed location.

Features

- Four standard programmable feature keys (Conference, Transfer, Line, Hold)
- Four programmable softkeys supporting up to 16 programmable features.
- Nine programmable line/feature keys
- Integrated speakerphone and mute keys
- Integrated push-to-talk functionality (Not available on NetLink s340 Docking Station)
- Charging cradle - provides full charge in approximately 1.5 hours.
- Menu and navigation buttons for simple feature activation
- Volume control
- Corded handset and standard dial pad

Note: Certain system setups will change functionality as described here. Please consult your system administrator if the functions on your Docking Stations are different from those listed here.

NetLink s340 Docking Station

The NetLink s340 Docking Station emulates the NetLink e340/h340 Wireless Telephone that is placed in the docking cradle. When a NetLink e340/h340 Wireless Telephone is placed in the docking cradle, the **Use Deskset** display will show on the handset and all functionality is transferred to the Docking Station.

NetLink s640 Docking Station

NetLink s640 Docking Station emulates the NetLink i640 Wireless Telephone that is placed in the docking cradle. When a NetLink i640 Wireless Telephone is placed in the docking cradle, the **Use Deskset** display will show on the handset and all functionality is transferred to the Docking Station. It performs all the functions described in this section and also supports the push-to-talk feature described below.

Docking Stations are not interchangeable. The NetLink e340/h340 will not fit into the docking cradle of the NetLink s640 Docking Station for the NetLink i640 Wireless Telephone and vice versa.

However, handsets are interchangeable. Any NetLink e340/h340 will work in any NetLink s340 Docking Station and any NetLink i640 Wireless Telephone will work in any NetLink s640 Docking Station.

Docking cradle

The docking cradle acts as a charger for the handset, whether it is powered on or off. While the handset is in the docking cradle, it is being charged.

Using the handset

The handset is available for use and may be activated simply by picking it up, at which time all functionality returns to the handset and the Docking Station is inactivated. The handset cannot be powered on or off while it is in the docking cradle.

Installation

The NetLink s340/s640 Docking Stations require the synchronization of hardware and software components for proper operation. In order to ensure a successful installation, please ensure that your site is running at least the minimum supported version of software listed below:

- NetLink 150 Gateway software version .085
- NetLink Wireless Telephone software e340/h340/i640 SRP version 89.102

For further instructions on how to identify your software version or to install these software updates, please refer to

<http://www.polycom.com/usa/en/support/voice/wi-fi/wi-fi.html>

To download the latest version of NetLink software, please refer to

<http://www.polycom.com/usa/en/support/voice/wi-fi/wi-fi.html>

For technical support or assistance, please contact your authorized SpectraLink reseller or our customer support center at

1-800-775-5330 or technicalsupport@polycom.com or

<http://www.polycom.com/usa/en/support/voice/voice.html>

Activate the Docking Station

The NetLink Docking Station is in standby mode when connected to power but not in use. It is not designed to be turned on or off.

When the handset is powered on and placed in the docking cradle, the Docking Station is activated and assumes the functionality of the NetLink Wireless Telephone.

All instructions below assume that a powered on handset is seated in the docking cradle and functionality is transferred to the Docking Station. All directions refer to the buttons and features on the Docking Station, not the handset.

Make a Call: Go off hook	Pick up the handset or press the Start Call button or the SPKR button. The dial tone indicates that you have an active line and may dial a number. The line number may appear on the display, replacing one of the nine “dots” at the top of the display (if supported).
Select a different line	(If available) The programmable Line keys are numbered 1 through 9 starting at the bottom. Press the Line key of the line you wish to use. A dial tone indicates the line is ready for use. You may also use the LINE button plus the number of the line you wish to activate.
Dial number	Dial calls with the NetLink Docking Station exactly as with any other desk handset. You may dial extension numbers, internal numbers, or make external calls, depending on the setup of your PBX.

Answer a Call

The NetLink Docking Station will ring to alert you to an incoming call. A line LED will flash (if supported), and the display may show information about the call, such as caller’s name and extension.

To answer a call, pick up the handset, hold the earpiece to your ear and speak with a normal tone of voice.

If the handset is not in its cradle, press the **Start Call** button to answer the call using the handset.

- Using the speakerphone** To answer a call by using the speakerphone, press the **SPKR** button or press or the **Start Call** button and speak at the NetLink Docking Station using a normal tone of voice.
- Answer a second line** If you are on a call and hear subdued ringing, a call is coming in on a second line. The line number on the display and the LED of the incoming line may be flashing. To answer this call, put your first call on hold and press the **Line** key of the second call.
- Hang up** At the end of each call, return the handset to the cradle or press the **SPKR** or **End Call** button. Be sure to do this at the end of each call.
- Change speaker volume** During a call, you may increase or decrease the volume of the speaker by pressing the corresponding **Up** or **Down** button located below the softkeys.

System Feature Activation



The features that have been programmed in your system may be viewed and activated through the Shortcut Menu and Softkey Functions. Place the NetLink Docking Station in active mode by picking up the handset or pressing the **Start Call** button or **SPKR** button. The Shortcut Menu, softkeys and system features then become available.

Navigation, and Volume buttons



Press the **^** and **v** buttons to highlight feature descriptions in the softkey function display area. To activate a feature, you may press its softkey, its shortcut key, or the **SEL** key while the option is highlighted.

CONF
TRNSFR
LINE
HOLD

The four buttons below the keypad are programmed for Conference, Transfer, Line and Hold. The functioning of these feature keys varies according to system. Contact your system administrator for information about using these buttons in your system.

The Shortcut Menu

Using the Shortcut keys

System features that are accessible by the NetLink Docking Station may be viewed by pressing the **MENU** button when you are off-hook. A feature menu displays in the Main display area. This is the Shortcut Menu.

Programmed features may have the number 1-9, *, 0, or # in the left column of the Shortcut Menu. This is the shortcut key that activates that feature. To activate the feature using its shortcut key, press the shortcut key at any time while in the Shortcut Menu. The feature will activate whether or not that feature is currently displayed or highlighted. No shortcut indicates that the feature does not have a shortcut key.

Example: If the Voicemail feature is programmed to shortcut key 2, the Shortcut Menu will display

2 Voicemail

When the **Voicemail** option is highlighted in the menu, **Vcml** will be highlighted in the softkey function display area.

To activate the Voicemail feature, press **2**.

You may also press the corresponding softkey.

Alternately, you may scroll to the option and press **SEL**.

If you are not already scrolling through the Shortcut Menu, simply press **MENU + 2** to activate the Voicemail feature.

The Line/Feature keys

There are nine line keys on the right side of the NetLink Docking Station. They are numbered from the bottom up with key 1 at the bottom and key 9 at the top. By default these keys are programmed to line appearances.

These keys can also be programmed to access PBX and other features of the telephone system. See your system administrator for information on the programming of these keys in your system.

Using the Softkeys

The softkeys on your NetLink Docking Station enable you to quickly activate system features. The softkeys display and may be activated when the NetLink Docking Station is off-hook. Pick up the handset or press the **SPKR** key to go off-hook.

There are four softkeys and up to 16 features programmed for softkey access. The display area directly above each softkey is programmed with a feature abbreviation to guide your access to the feature. The softkeys are referred to from left to right as A,B,C,D. In our diagram, the corresponding display area is labeled Aaaa, Bbbb, Cccc, Dddd.

The first set of softkey features are displayed in the softkey function display area by default. To view all of the features that can be activated through the softkeys, go off hook and then press the **FCN** key. The second set of feature abbreviations will display in the softkey display area. Each time the **FCN** key is pressed, a different set of features is displayed, until all configured features have been displayed. The softkey features display in the same sequence as they appear on the Shortcut Menu.

Activate any feature while its abbreviation is displayed by pressing the corresponding softkey.

Using the Shortcut keys While scrolling through the softkey functions, a shortcut key may be pressed to activate its corresponding feature, whether or not that feature is currently displayed in the softkey function display area.

Example: Using the previous example for the Voicemail function: If the Voicemail function is assigned to softkey A in the second set, then **Vcml** will display in the **Aaaa** softkey display area when the **FCN** key is pressed. Therefore, to retrieve your voicemail messages, press the **FCN** key + (softkey **A**).

Alternately, you may use the shortcut key by pressing **FCN + 2**. You may also press **MENU + 2** as described in the Shortcut Menu section above.

Push-to-talk (PTT) (NetLink s640 Docking Station only)

- The push-to-talk feature allows NetLink i640 Wireless Telephones to operate in a push-to-talk (PTT) group broadcast mode in addition to the standard telephone operation.
- Overview** This push-to-talk functionality is transferred to the NetLink s640 Docking Station when the NetLink i640 Wireless Telephone is placed in the docking cradle. The instructions below that refer to the Docking Station assume that there is an activated NetLink i640 Wireless Telephone in the docking cradle of the NetLink s640 Docking Station.
- The NetLink i640 Wireless Telephone supports eight channels with the current channel saved in memory on the NetLink i640 Wireless Telephone. A PTT call is initiated by pressing the **CONF** button located at the bottom of the Docking Station keypad. All NetLink i640 Wireless Telephones and Docking Stations that are monitoring that channel will hear the transmission.
- PTT dialogue is interrupted when you answer a PBX call. When the PBX call is ended, PTT dialogue resumes if in an active call.
- The PTT mode controls the keypad during a push-to-talk call period. Therefore it is not possible to use the keypad for any other function such as accessing the on-hook menus or accessing an OAI application unless the PTT call is Terminated (see below). However, it is possible to easily place a PBX call (see below).
- Selecting a channel** The channel for the Docking Station is selected in the NetLink i640 Wireless Telephone per user guide instructions for that device. The channel for the handset is set in the User Preference menu described in the handset user guide.
- Call period** The two-way radio operates on the concept of a push-to-talk session or call period. The push-to-talk call period begins with the first transmission and ends when there has been no two-way radio traffic on the channel for ten seconds.
- Initiating a call** Press and hold the **CONF** button to activate the channel before talking. The display will show **Transmitting** and you may begin talking.
- Transmitting** Once a call has been initiated, continue to hold the **CONF** button and talk into the speakerphone (i.e. talk at the handset like you would for a regular speakerphone call). When the **CONF** button is released, the NetLink Docking Station then enters the waiting state where it monitors the channel for up to ten seconds.
- Initiate subsequent transmissions by pressing the **CONF** button on any Docking Station or the PTT radio control button on any NetLink i640 Wireless Telephone using the same channel. The user can start talking immediately. The display screen shows the current active channel.
- If no transmission occurs during the ten-second countdown period, the Docking Station reverts to the idle state.

- Receiving** Upon receiving a PTT transmission, the Docking Station plays the “receiving alert” sound and enters the receive state.
- In this state the handset receives all conversations on the selected channel over the speakerphone. The NetLink Docking Station will ignore the **CONF** key while in the receive state.
- At the end of a transmission, the Docking Station enters the waiting state where it monitors the channel for up to ten seconds and displays **Waiting** on the screen. If no other transmission occurs within ten seconds the Docking Station reverts to idle state.
- Change PTT volume** While in PTT mode, use the **Volume** keys to raise or lower PTT volume. A separate volume is maintained for PTT calls with the current volume selection retained in memory.
- Muting a PTT call** To mute a current call, press the **Mute** soft key. This brings up a **Mute Two-Way Radio?** prompt. Press the **Yes** or **No** soft key. The prompt disappears after three seconds if the user doesn’t confirm either **Yes** or **No**.
- Mute only affects the current call and the Docking Station will play subsequent PTT calls. Mute does not allow the user to use the Docking Station keypad for anything else, including an OAI application.
- The **Mute** soft key turns into an **Unmute** soft key while in the mute state and can be used to unmute the PTT call (the confirmation prompt is displayed first).
- When the next PTT call period starts the audio is automatically unmuted.
- Early termination of a PTT call** In order to terminate an incoming PTT call, press the **Terminate** soft key and answer **Yes** to the confirmation prompt. Push-to-talk audio is immediately stopped and the Docking Station exits the PTT session. No other handset or Docking Station is affected. Only the current call is terminated for this Docking Station. When the next PTT call period starts, the Docking Station is again in the receive state. You may rejoin a still-active session by initiating a PTT call.
- Users should disable the PTT feature in the on-hook user menu in the NetLink i640 Wireless Telephone if no further PTT calls are desired.
- Incoming PTT call during a PBX call** The PTT “receiving alert” sound will play softly in the speaker audio, if a PTT session is started during a PBX call. You may continue your PBX call normally, or you may switch to the PTT call by ending the PBX call by pressing the **End Call** button.

- Incoming PBX call during a PTT call** A telephone call may be answered while in a PTT call session. To announce an incoming call, the NetLink Docking Station will ring with a low-volume ring and display the system message.
- To answer the call, press the **Start Call** button, the **SPKR** button, or lift the handset. The PTT call session will be pre-empted and no PTT audio will be heard.
- After the PBX call is over, press the **Start Call** button, the **SPKR** button, or hang up the handset as usual to go back on hook, at which time PTT goes out of pre-empted mode and becomes active again. If an already active PTT call has not ended, the PTT audio starts playing again.
- If the user does not answer the telephone call by pressing the **Start Call** button, the **SPKR** button or lifting the handset, the PTT display will be shown after the ring has stopped.
- Making a PBX call during a PTT call** To start a telephone call during a PTT call session, press the **Start Call** button, the **SPKR** button, or lift the handset. This causes the two-way radio to be pre-empted as described above.

Docking Station Charging Unit

- The docking cradle of the NetLink s340 Docking Station and NetLink s640 Docking Station acts as a charger for the handset. This docking cradle is designed to charge the Nickel Metal Hydride (NiMH) Battery Packs. Full charging is accomplished in approximately one and a half hours.
- See the section *Cleaning the Chargers* for information on the care of the docking cradle charging unit in the Docking Station.
- Using the docking cradle** Place the NetLink e340/h340/i640 Wireless Telephone into the Docking Station slot facing forward. When the handset is turned on and correctly inserted, the **Use Deskset** display will appear and functionality will be transferred to the NetLink Docking Station. The handset will immediately begin charging.
- You can place the handset in the docking cradle while in a call and the call is transferred to the NetLink Docking Station, in speakerphone mode (as shown by the **SPKR** LED lighting up). You can then lift the handset to continue the conversation over the handset if desired.
- Charging indicator** If the handset is in standby mode, it will display **Use Deskset** and **Charging. . .** If the handset is turned off, only **Charging. . .** will display. The dots will be racing during the charging cycle. It is normal for the Battery Pack to become warm when charging.
- Charge Complete** When the handset is fully charged, **Charge Complete** will replace the **Charging. . .** indicator.
- Melody** If the handset is off when placed in the docking cradle, it will charge. A melody is played after the handset is powered on for the first time following a completed charge (Charge Complete).
-

Battery Packs

Overview	The handset will need to have its Battery Pack recharged periodically. The Nickel Metal Hydride (NiMH) rechargeable handset Battery Pack gives you four hours of talk time or 80 hours of stand-by time (unless PTT is enabled in the NetLink i640 Wireless Telephone only). Stand-by time is when the handset is turned on, but not in an active call.
Indications of low battery	<p>The handset will notify you when the charge on the Battery Pack is low by displaying the battery icon. If you are in a call you will hear a soft beep through the earpiece every thirty seconds. User has 15–30 minutes of battery life left. The alerts will increase to every six seconds when there is about one minute of battery life left.</p> <p>Not in call: The message Low Battery and a loud beep indicate a critically low Battery Pack charge. These occur when the user is not in a call. The handset will not work until the Battery Pack is charged.</p>
Caution:	Take care not to short the battery contacts on the Battery Pack with metal objects such as coins, keys or paper clips. Shorting the contacts can cause permanent damage.
NetLink e340, h340 Battery Pack removal and replacement	<p>To remove, press down on the latch on the Battery Pack on the back of the handset. The Battery Pack releases outward.</p> <p>To replace, slide the lip of the Battery Pack into the bottom of the cavity. Push the top of the Battery Pack until it snaps into place. You should not have to force it against the handset.</p>
NetLink i640 Battery Pack removal and replacement	<p>To remove, hold the handset in one hand with the keypad facing up. Press both Battery Pack release buttons (on the left and right sides of the handset) at the same time. The Battery Pack will release downward. You may catch it with the palm of your other hand. If the Battery Pack does not release, gently shake the handset while pressing both release buttons. Do not pry.</p> <p>To replace, slide the Battery Pack straight into the cavity until it snaps into place. You should not have to force it against the handset.</p>
Changing the Battery Pack while in a call	If you are using the NetLink Telephony Gateway, the Battery Pack may be changed while the call is still in progress. Do not press End Call on the handset. Quickly remove the discharged Battery Pack and replace with a charged Battery Pack, then press Power On to turn the handset back on. Press Start Call to resume the call in progress.
Battery Pack note	Battery Packs are not interchangeable. The NetLink i640 Wireless Telephone uses the distinctive square model BPX100 Battery Pack. The Battery Packs for the NetLink e340 and h340 Wireless Telephones are the same rounded shape but different colors. The NetLink e340 model BPE100 Battery Pack is black; the NetLink h340 model BPN100 Battery Pack is steel blue.

Important:

Only use SpectraLink Battery Packs with SpectraLink Wireless Telephones.

Do not dip the Battery Pack in water or throw into fire.

Do not throw away the Battery Pack with your domestic waste. Take used Battery Packs to an appropriate collection point for recycling or send them back to your supplier or servicing agent.

NetLink Desktop Chargers



NetLink e340 Wireless Telephone
In DCE100 Desktop Charger



NetLink i640 Wireless Telephone
in DCX100 Desktop Charger

Overview The NetLink Desktop Charger is a one-slot charger available in two models. Model DCE100 is designed to charge the NetLink e340 Wireless Telephone with the BPE100 Battery Pack or the NetLink h340 Wireless Telephone with the BPN100 Battery Pack. Model DCX100 is designed to charge the NetLink i640 Wireless Telephone with the BPX100 Battery Pack. The models are not interchangeable.

Full charging is accomplished in approximately one and a half hours.

Set up the Desktop Charger by first obtaining the appropriate SpectraLink power supply for the country or region. Place the Desktop Charger on a flat, horizontal surface. Plug the power supply into the Desktop Charger and into an appropriate wall outlet.

The user must end any call in progress by pressing the **End Call** button on the handset before placing the handset into the Desktop Charger. The handset may be off or in standby mode during charging.

Indicator light Place the NetLink Wireless Telephone into the Desktop Charger slot facing forward. If the handset is placed correctly, the red indicator light will come on. The indicator light will not come on when the slot is empty, when the NetLink Wireless Telephone is improperly seated, or when the Desktop Charger has no power applied.

Charging indicator While the handset is charging in standby mode, it will display its extension number and **Charging....** The battery icon will show charging progress. The handset is fully operational and will ring if called. When the handset is charging while turned off, only **Charging...** will display and no calls will be received. The dots will be racing during the charging cycle. It is normal for the Battery Pack to become warm when charging.

Charge Complete When the handset is fully charged, **Charge Complete** will display. The indicator light will remain on until the handset is removed.

NetLink Dual Chargers



**NetLink e340 Wireless Telephone
In DCE200 Dual Charger**



**NetLink i640 Wireless Telephone
in DCX200 Dual Charger**

Overview The NetLink Dual Charger is a two-slot desktop charger. Model DCE200 is designed to charge the NetLink e340 Wireless Telephone and a spare BPE100 Battery Pack; Model DCX200 is designed to charge the NetLink i640 Wireless Telephone and a spare BPX100 Battery Pack; Model DCN200 is designed to charge the NetLink h340 Wireless Telephone and a spare BPN100 Battery Pack. The models are not interchangeable.

Set up the Dual Charger by first obtaining the appropriate SpectraLink power supply for the country or region. Place the Dual Charger on a flat, horizontal surface and plug the power supply into the Dual Charger and into an appropriate wall outlet.

The user must end any call in progress by pressing the **End Call** key on the handset before placing it into the Dual Charger. Do not remove the Battery Pack. The handset may be off or in standby mode during charging.

Place the handset face forward into the Dual Charger front slot. Place a spare Battery Pack in the rear slot, charging contacts down. The front slot takes charging precedence; the Battery Pack in the rear slot will begin charging when the handset in the front slot is fully charged or when the front slot is empty.

Indicator light When the handset or Battery Pack is seated correctly, the corresponding indicator light will come on. A bright indicator means the Battery Pack is charging, a dim indicator means the Battery Pack is waiting to charge. The indicator light will not come on when the handset is incorrectly seated, the slot is empty or when the Dual Charger has no power applied. If the indicator light is off or flashing, it means the handset or Battery Pack is incorrectly seated. Remove the handset or Battery Pack and reinsert. If the LED continues to blink or starts blinking at any time during the charging process, it indicates that there is a problem with the Battery Pack that makes it unusable. Do not continue to charge the Battery Pack. Dispose of it properly and do not attempt to use it in the handset. Do not attempt

to open or repair a defective Battery Pack. Contact your service representative for assistance.

The indicator light will turn off when charging is complete. Full charging is accomplished in approximately two hours for either slot.

- Charging indicator** While the handset is charging in standby mode, it will display its extension number and **Charging....** The battery icon will show charging progress. The handset is fully operational and will ring if called. When the handset is charging while turned off, only **Charging...** will display and no calls will be received.
- Charge Complete** When the handset is fully charged, **Charge Complete** will display. If the handset has been turned off, the charge complete melody will play when it is turned on.
-

NetLink Quad Chargers



**NetLink Quad Charger
Model GCN100**

(shown with four empty charging bays)



**NetLink Quad Charger
Model GCX100**

(shown with two empty charging bays)

-
- Overview** The NetLink Quad Charger is designed to simultaneously charge four Nickel Metal Hydride (NiMH) Battery Packs. Model GCX100 is designed to charge the BPX100 Battery Pack for the NetLink i640 Wireless Telephone. Model GCN100 is designed to charge the BPN100 Battery Pack in the NetLink h340 Wireless Telephone. Full charging is accomplished in approximately one and a half hours.
- Power supply** Set up the Quad Charger by first obtaining the appropriate SpectraLink electrical supply for the country or region. Place the Quad Charger on a flat, horizontal surface and plug the power supply into the Quad Charger and into an appropriate wall outlet.
- Removing and replacing a Battery Pack** To remove the Battery Pack from the NetLink i640 Wireless Telephone, hold handset in one hand with the keypad facing up. Press both battery release buttons on the left and right sides of the handset at the same time. The Battery Pack will release downward. You may catch it with the palm of your other hand. If the Battery Pack does not release, gently shake the handset while pressing both release buttons. Do not pry.
- Remove the Battery Pack from the NetLink h340 Wireless Telephone by pressing down on the latch on the Battery Pack on the back of the handset. The Battery Pack releases outward.
- Insert the Battery Pack into one of the four charging bays so that the Battery Pack contacts meet the charging bay contacts. The LED above the charging bay will turn on to indicate that charging is in progress. Complete charging occurs in one and a half to two hours. When charging is complete, the LED will turn off. Lift the Battery Pack out of the charging bay.
- Blinking LED** If the LED starts blinking as soon as the Battery Pack is inserted, the Battery Pack may be improperly seated. Lift it out and reinsert. If the LED continues to blink or starts blinking at any time during the charging process, it indicates that there is a problem with the Battery Pack that makes it unusable. Do not continue to charge the Battery Pack. Dispose of it properly and do not attempt to use it in the handset. Do not attempt to open or repair a defective Battery Pack. Contact your service representative for assistance.
- To place the Battery Pack into the NetLink i340 Wireless Telephone, slide the Battery Pack straight into the cavity until it snaps into place. You should not have to force it against the handset.

To place the Battery Pack into the NetLink h340 Wireless Telephone, slide the lip of the Battery Pack into the bottom of the cavity. Push the top of the Battery Pack until it snaps into place. You should not have to force it against the handset.

Note for Argentina

Power adaptors will not be supplied for products shipped to Argentina. Power adaptors must be obtained within the country. Therefore for Argentina, the following applies:

Only certified power adaptors with the following electrical characteristic shall be used. The use of different adaptors could damage the device, present hazards to the user, and declare the product warranty void.

Input rating: 220 VAC, 50/60 Hz

Output rating: 12VDC, 2A

(With less than 1V peak to peak ripple at 2 amps)

- Output cable should not be any longer than two meters.
 - Output plug must be the following dimensions (5.5 x 2.1 x 8 to 11 mm).
 - The center pin of the DC output plug must be positive voltage. The outer shell of the DC output plug must be negative.
-

Important Notes about Chargers and Battery Packs

Chargers operate in a 50° to 85° F (10° to 30° C) environment. Do not expose them to freezing temperatures or direct sunlight.

Do not place anything in the charger other than the handset. You might damage the contacts. Bent contacts can keep the handset from charging.

It is normal for the Battery Pack to become warm when charging.

Only use SpectraLink Battery Packs with SpectraLink chargers.

Never use non-SpectraLink charging units as they could damage the Battery Pack.

Only use the original plug-in power adapter for the chargers.

Do not dip the Battery Pack in water or throw into fire.

Do not throw away the Battery Pack with your domestic waste. Take used Battery Packs to an appropriate collection point for recycling or send them back to your supplier or servicing agent.

Replacement Battery Packs are available from your supplier or servicing agent.

General Care of the Handsets and Chargers

- This section applies to all NetLink Wireless Telephones, the Docking Station and all SpectraLink chargers.
- Do not drop** Avoid dropping the handset or knocking it against hard surfaces. Carrying the handset in a holster or carrying case will help to protect it.
- Do not disassemble** There are no serviceable parts in the handset, Docking Station or chargers. You should not open the handset case nor disassemble the Docking Station or the chargers. Doing so will void your warranty.
- Cleaning tips** Turn off the handset and unplug the Docking Station and chargers before you clean them. Never immerse either in water. Clean the exterior surfaces, including the charging contacts, with a cloth that has been slightly moistened with water. Take care not to exert undue pressure on charger electrical contacts while wiping.
- Wiping the handset and Docking Station surface with a water-dampened cloth or paper towel will remove most films or residues. If the soiling is too stubborn for plain water, a mild detergent solution may be used. Be sure to wipe away any detergent residue with a clean water-dampened cloth.
- The handset and Docking Station may be cleaned with any general-purpose household glass and surface-type cleaner. **DO NOT SPRAY THE HANDSET DIRECTLY!**
- Pre-treated cloths such as used for eyeglasses or cameras may be used to clean the handset and Docking Station. Pre-moistened towelettes may also be used to clean the handset, however, avoid those containing lanolin or aloe as it will leave a slippery residue.
- The surface of the handset and Docking Station may be cleaned occasionally with disinfectants used for general cleaning in a medical environment. Isopropyl alcohol may be used occasionally applied by a damp cloth or paper towel. When using alcohol, do not rub the keypad characters vigorously. Doing so will significantly degrade legibility.
- Do not use furniture polishes, waxes or plasticizer-based cleaner (Armor All™, etc.)
- Do not use lanolin, aloe, glycerin or other skin care type products.
- Do not apply any solvent such as acetone, mineral spirits etc.
- Do not directly spray or immerse the handset.
- Headset cleaning** Should the headset connector become dirty, a scratchy or intermittent signal may be experienced. To clean the connector, dip the non-padded end of either a wooden or paper handled cotton swab in isopropyl alcohol. Gently insert in the connector and twist, repeating several times. If available, blow compressed air into the connector to clear debris.
-

Tips for Use

- Before you use the handset, the Battery Pack must be charged.
 - You can only use the handset with your facility's telephone system. It is not a public cellular handset.
 - Keep the handset away from your ear when it is ringing.
 - The microphone is between the **FCN** and **LINE** keys. This is a sensitive microphone that works well when the handset is correctly positioned on your ear. There is no need to speak directly into the microphone, but do not cover it with your hand or cheek when talking.
 - The LCD panel displays information about the status of your handset and prompts you about features.
 - If the Battery Pack is low, you will hear a soft beep and see the empty battery icon in the display.
 - Improper disposal of Battery Packs can damage the environment. Dispose of batteries properly.
 - You can control the handset volume level and the type of ring.
 - To protect the handset, use a carrying case.
-

PLEASE NOTE:

It is recommended that standard acceptance procedures be followed prior to operating this equipment in proximity of life-support systems.

To minimize risk of interference, pacemaker users should not carry the handset next to the pacemaker.

Earpiece may retain magnetic objects.

Operation of the handset and Docking Station may produce an audible noise noticeable to hearing aid users. It is recommended that a hearing aid compatible headset be used by hearing aid users.

WARNING Changes or modifications to this equipment not approved by SpectraLink Corporation may cause this equipment to not comply with part 15 of the FCC rules and void the user's authority to operate this equipment.

WARNING SpectraLink products contain no user-serviceable parts inside. Refer servicing to qualified service personnel.

Appendix A: Cisco SCCP Protocol

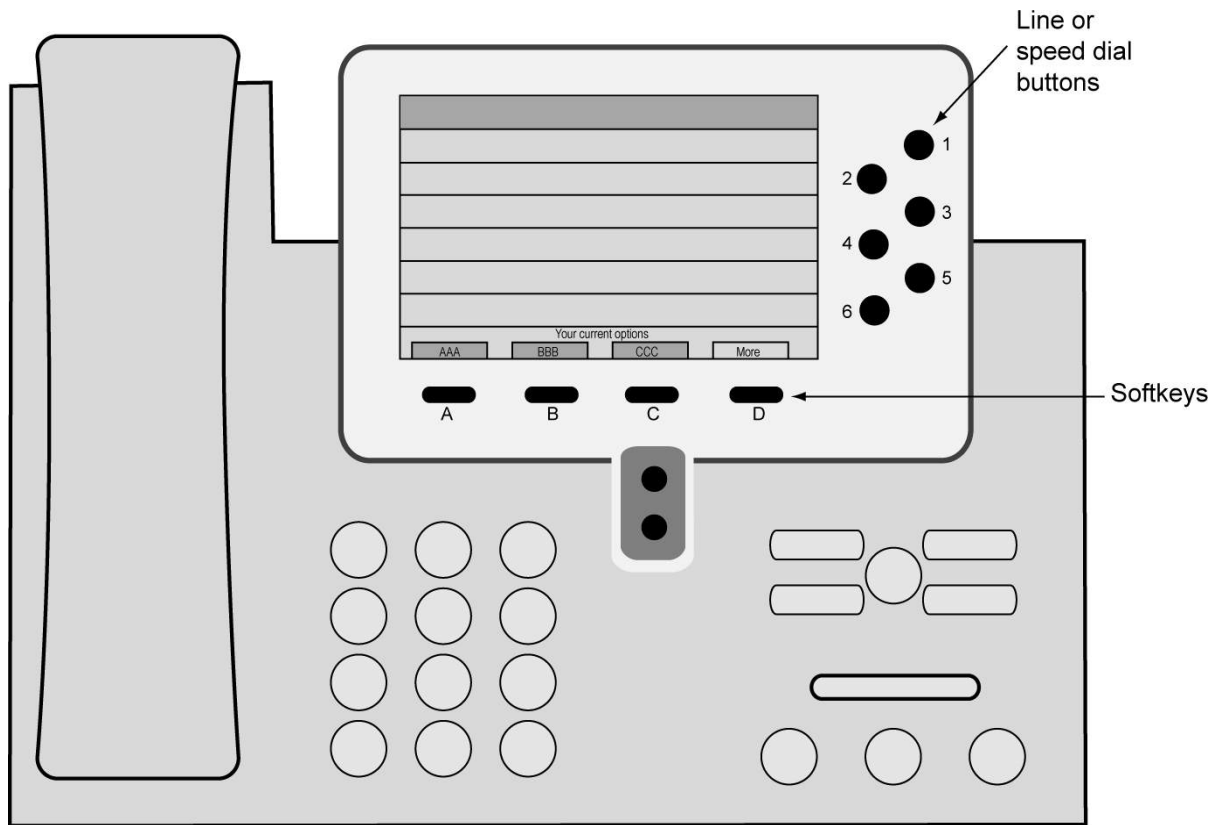

Cisco IP Phone 7960 – phone type emulated by the NetLink Wireless Telephone

Overview

The NetLink Wireless Telephone emulates the Cisco IP Phone 7960, shown above. Certain features and handset operations vary from the SRP protocol. These variations are explained in this appendix.





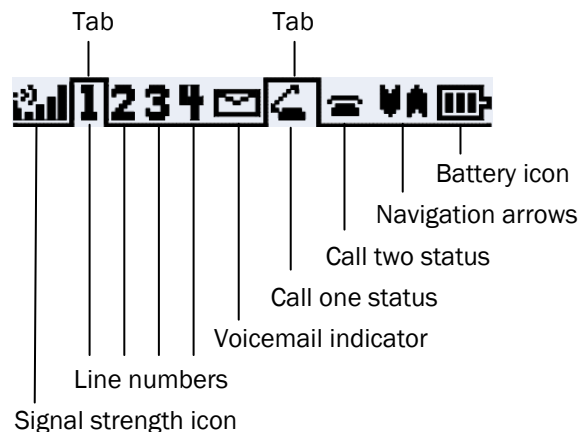

- Status display area** When active, the handset displays a row of line icons at the top of the screen. Information from the PBX is shown on the text row above the softkeys. Note that text may be truncated to 16 to 19 characters on the handset. **<Muted>** is displayed on the second text row when local muting is activated.
- LINE display** Pressing the **LINE** key from the active mode displays a list of line appearances extracted from the programmable keys list. The line appearances are also mapped to corresponding line icons.
- FCN display** Pressing the **FCN** key from the active mode displays the Mute, Voicemail, OAI functions and the speed dial list.

Feature Access

- Pre-dialing** All features are viewed with the handset off hook. Press the **Start Call** button to go off hook. To dial a call, you may use predialing by dialing the number and then pressing **Start Call**.
- Line appearances** Press the **Line** key to view a list of available line appearances and their assigned extensions. To access a line and make a call, press the corresponding key. Press the **End Call** button to exit the Line Appearance list.
- Speed Dial, Mute, Voicemail and OAI** Press the **FCN** key while off hook to display the Mute, Voicemail and OAI features and the first four items in the speed dial list. Activate the feature by pressing the corresponding key as shown on the display or by pressing the shortcut key. Press **FCN** again to scroll through the programmed features. Press the **End Call** button to exit the Function list.
- Access programmed features** Whenever the handset is active, the softkey abbreviations display. Each feature abbreviation is shown above the corresponding softkey. Pressing the feature's corresponding softkey or pressing the **MENU** key plus the shortcut key will activate the feature. Press the **MENU** key for an expanded description of the softkey features. Use the side buttons (**Up, Select, Down**) to scroll through the features. The **Select** button will activate the selected feature. Pressing the softkey or shortcut key will activate the feature even if it is not selected or shown on the **MENU** display. Press the **More** softkey to display the next set of programmed features. Press the **End Call** button to exit the Feature list.
- Multiple calls per line** The handset supports two calls per line. Call icons display the status of each call to help you keep track of the calls.
- Icons** In order to accommodate four line appearances with two possible calls on each, the handset display has been modified. The top row displays the signal strength icon, the four line appearance numbers, the voicemail indicator (replaced by the downloader icon when the handset is downloading code), a call status icon for each call, navigation arrows, and the battery icon as shown here:



The tabs indicate which line and which call is active. In the above display, line one is in an active call. The second call for line one is on hook.

Call Status Icon	Call State	Description
	On Hook	The line is not in use.
	Off Hook	The line is in use. There is a dial tone or there is an active call.
	Hold	The call has been placed on hold.
	Incoming call ringing. Icons flash through three views.	The line is ringing.
	Outgoing call, ringing. Icons flash between two views.	An outgoing call is ringing on the called party's line.
	Shared line is in use. Icons flash between two views.	The shared line is in use by another party and is not available for incoming or outgoing calls.

If you want to... Then...

Make a second call on the same line

Press the **Hold** softkey to put the current call on hold.

Press the **Select** button to switch to the second call. The tab moves to the second call icon, which is on-hook.

Press the **Nwcl** softkey. A dialtone is heard and the off-hook icon displays.

Dial the number. The outgoing call icon displays. The handset display shows the information for the called party.

Answer a second call on the same line

The incoming call icon displays for the second call and there is a soft ringing in the ear.

Press the **Hold** softkey to put the current call on hold.

Press the **Select** button to switch to the second call. The tab moves to the second call and caller information is displayed on the handset.

The handset automatically answers the second call. Simply speak into the handset.

Return to the first call

Press the **Hold** softkey to put the second call on hold.

Press the **Select** button to return to the first call. The tab moves to the first call icon and the hold icon is displayed. The handset displays information about the first call.

Press the **Resume** softkey to activate the call.

End the first call and resume the second call

Press the **End Call** key. The first call terminates and the on-hook icon displays.

Press the **Select** button. The tab moves to the second call and the call is automatically resumed.

Appendix B: ITU H.323 Protocol

Overview

H.323 is a basic interface that may permit limited feature applications accessed via in-call dialing. Certain proprietary H.323 architectures use DISA (Direct Inwards Service Access) to access telephony services. In these systems, the handset automatically dials the DISA number when **Start Call** is pressed.

Contact your system administrator for additional information about the exact features available in your facility.

Feature Access

Mute	The Mute feature is assigned to FCN 1 .
Custom feature programming	All other features in your H.323 system accessed via in-call dialing are available by the appropriate dial sequence. The Start Call key will send the hookflash (!) signal.
Language	If custom feature menus have been made available in multiple languages, these will be listed on the Standby menu. Select the desired language from the Standby menu.
Custom feature menus	<p>When configured at the system level, two feature menus can be activated, one from the standby state—the Pre-dial menu—and one from the off-hook state—the Post-dial menu.</p> <p>The Pre-dial menu is activated from the standby state by pressing the MENU key. An option can then be selected from the Pre-dial menu and the handset will dial the programmed sequence. There may be up to 31 Pre-dial options in each programmed language.</p> <p>The Post-dial menu is activated from the off-hook state by pressing the MENU key. An item may be selected from this menu which will initiate the programmed dial sequence. There may be up to seven Post-dial options per language.</p> <p>If no option is selected from the menu within ten seconds, the handset reverts to the previous standby or off-hook state. Any call in progress when entering the Pre- or Post-dial menu will be unaffected.</p>
Pre-dial menu	The Pre-dial menu is used when not in an active call. The Pre-dial menu is accessed only when the handset is in standby mode.
Post-dial menu	The Post-dial menu is available only during the off-hook state or while in an active call. If the handset is in standby mode and the user presses the Start Call key, the user will hear a dial tone, indicating the off-hook state. In many cases the Post-dial code is not operational before a phone number is dialed, but this is managed by the PBX.

Feature activation

1. Press the **Start Call** button followed by the **MENU** key. The Pre-dial labels and corresponding shortcut codes are displayed.
 2. Navigate the list using the side **Up** and **Down** buttons. The list is circular. Alternatively, the **MENU** button may be pressed repeatedly to display the next set of four options.
 3. Select the feature by pressing the **OK** soft key. Alternatively, press the **Select** button or dial the shortcut, if available. The handset then sends the programmed codes to the PBX.
 4. The **Exit** soft key or **End Call** key can be used to terminate prior to making a feature selection.
 5. There is a ten second timeout which will return the handset to the previous state if no additional keys are pressed while in either Pre-dial menu or pre-dial mode.
 6. The PBX could automatically release the call in some cases. In this case the handset returns to the Standby mode.
 7. There is a ten second timeout which will return the handset to the previous state if no additional keys are pressed while in the Post-dial menu.
-

Appendix C: Mitel Networks

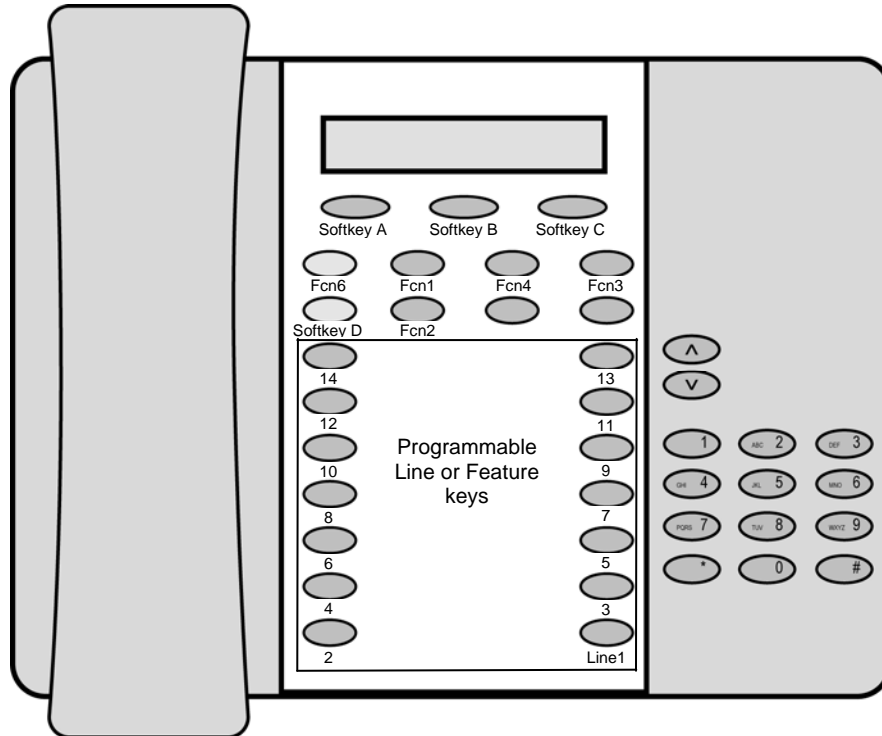

Overview

The NetLink Wireless Telephone emulates the Mitel Networks 5220 IP Phone, shown above, including: superkey, local muting, timed reminder, ringer adjust (via superkey), forwarding (via superkey), hot desk, auto answer (via superkey), and resiliency. Some or all of these features may be implemented locally.

All telephone functions and messaging features are supported if possible. Speakerphone functions are not supported.

Certain features and handset operations vary from the SRP protocol. These variations are explained in this appendix.

In its standby state, the handset displays the extension assigned to this handset. The active state is initiated by pressing either the **Start Call** key or the **MENU** key. When the active state is initiated, the handset contacts the PBX and displays the data provided – the time, date, default line icon, any voicemail icon, and softkey and feature key labels.

If the **Start Call** key has been pressed, the handset is off-hook and there is a dial tone.

If the **MENU** key is pressed, there is no dial tone; pressing **MENU** again will bring up the Menu display.

While in the active state, you may switch to any display – Line, Feature, or Menu – by pressing its corresponding key. Pressing a softkey will activate the feature displayed.

- Status display area** When active, the handset displays a row of line icons at the top of the screen. Information from the PBX is shown on the text row above the softkeys. **Muted** is displayed when local muting is activated. The PBX text may be truncated to 18 characters.
- LINE display** While off hook, press the **LINE** key to view the shortcut keys and assigned extensions for line appearances. There are nine possible line appearances that correspond to the nine indicators at the top of the handset display. When a line is in use, the indicator converts to the line number and a **+** will appear after the shortcut key on the list, emulating a lit LED. Press the **LINE** key again to display the second page of the list if more than four line keys have been programmed. To use an extension, press the corresponding shortcut key. You may also use the **Up**, **Down**, and **Select** side buttons to scroll through the displays and activate the line appearances on this list. Up and down arrows on the display indicate additional items may be viewed by using the side buttons. Press the **End Call** key to exit the Line Appearance list.
- MENU display** The softkey labels on the handset are truncated to four characters. The complete text for each softkey may be displayed by pressing the **MENU** key from the standby state. The shortcut key assigned to the softkey feature and the complete text for each of the softkeys displays.
- Activate the softkey features while in the Menu display by pressing the softkey, pressing the shortcut key, or using the **Up**, **Down**, and **Select** side buttons to scroll through and activate the features on this list. Up and down arrows on the display indicate additional items may be viewed by using the side buttons. Press the **End Call** key to exit the Menu display.
- FCN display** The NetLink implementation supports five fixed features that are suitable to a mobile user through the Function (**FCN**) key on the handset. When **FCN** is pressed, the display lists the first four fixed features and the assigned shortcut key. Pressing **FCN** repeatedly will display the remaining items on the list, along with any shortcut key, as available. A “+” will appear after the shortcut key, which emulates a lit LED on the emulated desk phone, indicating that the corresponding feature is turned on. OAI options appear at the end of the list. All OAI keys will preempt shortcuts assigned to other keys.
- Activate the fixed features on the off-hook handset by pressing **FCN** + the shortcut key. You may also use the **Up**, **Down** and **Select** side buttons to scroll through and activate the features on this list. Up and down arrows on the display indicate additional items may be viewed by using the side buttons. Press the **End Call** key to exit the list.
-

Feature Access

Shortcut keys	Press the FCN key to scroll through the feature list. Press a shortcut key per the table below to activate system features.
First screen	1 Trans/Conf 2 Cancel 3 Message 4 Redial
Second screen	5 Mute/Unmute 6 Superkey/Hold 7 [may be locally programmed] 8 [may be locally programmed]
Third screen	9 [may be locally programmed] [may be locally programmed] [may be locally programmed]
Fourth screen, etc. ¹	[may be locally programmed] *(OAI) 0 (OAI) # (OAI) <i>See FCN Display above for explanation of OAI position.</i>
Hold/Superkey	The Hold feature is assigned to softkey D. To place a call on hold, press the softkey on the far right. The superkey and hold features swap places depending on the mode of the handset. When in a call, the superkey is menu item FCN + 6 and the Hold feature is available through softkey Dddd. When not in a call, the superkey (Skey) is available as softkey Dddd and the Hold feature is displayed as number 6 on the Feature list.
Hot Desking	The Mitel PBX allows configuration of a hot desking feature which allows a handset to register with the PBX as a different extension. If so configured, a HDsk softkey in position Cccc will appear on the handset in the active (on-hook) mode. To change the extension on the handset and log in as a different user, press the HDsk softkey. When the hot desk softkey is pressed, the PBX displays No user logged in and the current extension. Press the Login softkey (Logi) and enter the new extension. Press the OK softkey. The display prompts for a PIN number. Enter the PIN and press the OK softkey. The handset will display Get button defs as it checks in with the PBX. Once registration is complete, the new extension will display and the handset will be in standby mode.
Paging	The handset does not incorporate speakerphone capabilities and therefore receiving a page is not supported. The user may send a page if this feature has been programmed.

¹ Note: There may be more features programmed than there are available shortcut keys. In this situation, the feature may be activated by using the Up, Down, Select buttons on the side of the Wireless Telephone.

Appendix D: SIP (Session Initiation Protocol)

Overview

In the SIP environment, certain features and handset operations vary from the SRP protocol. These variations are explained in this appendix. Please contact your phone system administrator if you have questions about handset features and functionality.

- Softkeys** Softkey functions change as the state of the handset changes. Softkeys are displayed only when they are available to be activated. Softkeys make usual PBX functions available on the handset. For example, a call may be placed on hold, the handset may be muted, and a second line may be activated for an outgoing call or a second call on the same line may be answered. Calls may also be transferred to another number, either as a consulted transfer or without consult. Other handset features (DND, Transfer) may be accessed by pressing the **FCN** key.
- Alphanumeric dialing** Number dialing may be specified as alpha or numeric code by pressing **Start Call** plus the **MENU** key. Select **Alpha Dialing** if letters and symbols are to be entered in the dialing string.
- When dialing, the carat (^) indicates the insertion point for the next character. Up to 80 characters may be entered with automatic scrolling. While in alphanumeric mode, alphabetic characters can be entered by repeatedly pressing the 1 through 9 keys. Punctuation characters are available by repeatedly pressing the asterisk (*), zero (0) or pound (#) keys. Row 5 displays the available characters as the key is pressed. Pausing will enter the highlighted character in the dial string. A space character is available on the pound key or by pressing the >> softkey when the insertion point is at the end of the dial string. The << and >> softkeys may be used to position the insertion point for editing the entry. Press the **Dele** softkey to delete the character prior to the insertion point. Insert a character by pressing its key.
- Default line appearance** By default, the username assigned to the line one appearance is displayed on the standby screen.
- LINE display** View the five line appearances by pressing the **LINE** key. The line number and extension number of the first four lines are displayed. Press the **LINE** key again to view the fifth line. Active lines are in bold face. Defined but unregistered lines are faded. Lines that have been forwarded are prefixed with the greater-than character (>) followed by the forwarding destination.
- The **LINE** menu will display a plus (+) indication when there is a new voicemail for that line. See *Voicemail* below.
- Push-to-talk caller ID** The line one appearance username is used as a caller ID for the push-to-talk application. (NetLink i640 Wireless Telephone only)

Basic Operation

Making a call	From the standby mode or after pressing the Start Call key, dial the number (or dialing string). Press the Dial softkey or the Start Call key to activate the first available line and place the call.
Select a different line	From the standby mode or after pressing the Start Call key, press the LINE key plus the line number.
Answering a call	<p>When the handset rings, the line's icon will flash and row 2 will display the line number and your dial number. Row 4 will display Fr (From) and the caller ID of the incoming call.</p> <p>Press the Start Call key or the Answ softkey to answer the call. Press Rej to reject the call and allow the call to be redirected to voicemail.</p> <p>When the call is answered an asterisk (*) displays at the start of row 4 which indicates that this line is in an active call with established audio connection.</p>
Place a call on hold	Press the Hold softkey. When a call is placed on hold, an equal character (=) replaces the asterisk (*) and the Rsmc softkey displays.
Mute the handset	Press the Mute softkey. When the handset is muted, an x character replaces the asterisk (*). Press the Mute softkey again to restore audio pickup.
Place a second call on the same line	<p>Only outgoing calls are permitted as the second call on a given line.</p> <p>To access the second call dial tone, press LINE + [the line number]. Dial the number to place the second call. When a second call is active on the same line appearance, the second call appears below the first on the handset display. Use LINE + [the line number] to toggle between calls. The selected call is in bold type the other call is faded.</p>
Call waiting	<p>When another call comes in on a different line, the called line icon flashes and a tone sounds in the audio stream.</p> <p>To view the caller ID of the incoming call without interrupting the active call, press LINE + [the line number]. The display now shows information about the incoming call and you will continue hearing audio on the first call.</p>
Answer a second call	Press Answ or Start Call to answer the incoming call and place the active call on hold. Press the Rej softkey to refuse the incoming call. Pressing the Rej softkey will redirect the incoming call to voicemail or as otherwise programmed.
Redial	When available, the left ReDI softkey may be pressed to redial the last number called.
Forward (Local)	<p>Calls may be forwarded on a per-line basis. To forward calls on a given line, press LINE + [the line number], press the FWD softkey and enter the forwarding destination. Press the SAVE softkey to save the forwarding destination. Cancel forwarding by pressing the FWD softkey again.</p> <p>The LINE display will indicate if a line is forwarded by a > character followed by the destination address.</p> <p>If any line is forwarded, the standby screen will display forwarding status. If the do-not-disturb feature is enabled, the forwarding status will be pre-empted by the Do Not Disturb display.</p> <p>If a given contact number has multiple appearances on the handset, forward the lowest line appearance to forward all calls to that</p>

number on any line appearance.

**Transfer
(Local)**

In order to transfer an active call, press **FCN 1**. This places the call on hold and gives you a dial tone for a second call on the same line appearance. Dial the number that you want to forward the call to and then press **FCN 1** again. The dialed number is called and your call is disconnected. This is a blind transfer. For a consulted transfer, press **FCN 1**, dial the number, and then press the **Dial** softkey. When the party answers, have your conversation and then press **FCN 1** to transfer the held call and disconnect the first call.

If the second call on the active line appearance is already in use, a consulted transfer is made to the party on that call. Press **FCN 1** to place the first call on hold and converse with the second call. Press **FCN 1** again to transfer the held call and disconnect both calls.

**Do not disturb
(Local)**

Activate the do-not-disturb feature to reject all incoming calls with a busy indication by pressing **FCN 2**. The handset will not ring for new incoming calls. Press **FCN 2** again to resume ringing.

When the do-not-disturb feature is enabled, the standby screen will display **Do Not Disturb**.

Voicemail

When the voicemail icon displays dial the number assigned to message retrieval and follow system instructions to retrieve messages.

Alternately, if configured, the voicemail system can also be accessed by pressing the **Msg** softkey, which will appear after selecting a line and before beginning to dial.

The **LINE** menu will display a plus (+) indication when there is a new voicemail for that line. Indications are cleared when the handset receives notification that all new voicemail messages have been read.

Safety and Regulatory Information



WARNING: SpectraLink products contain no user-serviceable parts inside. Refer servicing to qualified service personnel.

WARNING: Changes or modifications to this equipment not approved by SpectraLink Corporation may cause this equipment to not comply with part 15 of the FCC rules and void the user's authority to operate this equipment.

NOTE CONCERNING THE WIRELESS TELEPHONES

This device complies with part 15 of the FCC Rules. Operation is subject to the following two conditions: (1) This device may not cause harmful interference, and (2) this device must accept any interference received, including interference that may cause undesired operation.

OPERATIONAL WARNINGS

For Vehicles Equipped with an Air Bag: Do not place a portable radio product in the area over the air bag or in the air bag deployment area. An air bag inflates with great force. If a portable radio is placed in the air bag deployment area and the air bag inflates, the radio product may be propelled with great force and cause serious injury to occupants of the vehicle.

Potentially Explosive Atmospheres: Turn off your radio product, prior to entering any area with a potentially explosive atmosphere. Do not remove, install, or charge batteries in such areas. Sparks in a potentially explosive atmosphere can cause an explosion or fire resulting in bodily injury or even death.



The areas with potentially explosive atmospheres referred to above include fueling areas such as below decks on boats, fuel or chemical transfer or storage facilities, areas where the air contains chemicals or particles, such as grain, dust or metal powders, and any other area where you would normally be advised to turn off your vehicle engine. Areas with potentially explosive atmospheres are often but not always posted.

Batteries: All batteries can cause property damage and/or bodily injury, such as burns if a conductive material such as jewelry, keys, or beaded chains touches exposed terminals. The conductive material may complete an electrical circuit (short circuit) and become quite hot. Exercise care in handling any charged battery, particularly when placing it inside a pocket, purse, or other container with metal objects.

Cleaning and Drying Considerations Using a leather carry case may help protect the surfaces and help prevent liquids (e.g., rain) from entering into the interior of the radio product. This product is not waterproof, and exposing the unit to liquids may result in permanent damage to the unit.

If your Wireless Telephone interior gets wet, then do not try to accelerate drying with the use of an oven or a dryer as this will damage the Wireless Telephone and void the warranty. Instead, do the following: 1. Immediately power off the Wireless Telephone. 2. Remove Battery Pack from Wireless Telephone. 3. Shake excess liquid from the Wireless Telephone. 4. Place the Wireless Telephone and Battery Pack in an area that is at room temperature and has good airflow. 5. Let the Wireless Telephone and Battery Pack dry for 72 hours before reconnecting the Battery Pack and/or powering on the Wireless Telephone. If the Wireless Telephone does not work after following the steps listed above, contact your dealer for servicing information.

ELECTRO MAGNETIC INTERFERENCE/COMPATIBILITY



Nearly every electronic device is susceptible to electromagnetic interference (EMI) if inadequately shielded, designed or otherwise configured for electromagnetic compatibility.

Facilities

To avoid electromagnetic interference and/or compatibility conflicts, turn off your radio product in any facility where posted notices instruct you to do so. Hospitals or health care facilities may be using equipment that is sensitive to external RF energy.

Medical Devices

Pacemakers: The Health Industry Manufacturers Association recommends that a minimum separation of 6 inches (15 cm) be maintained between a handheld wireless radio product and a pacemaker. These recommendations are consistent with the independent research by, and recommendations of, Wireless Technology Research. Persons with pacemakers should:

- ALWAYS keep the radio product more than 6 inches (15 cm) from their pacemaker when the radio product is turned ON.
- Not carry the radio product in a breast pocket.
- Use the ear opposite the pacemaker to minimize the potential for interference.
- Turn the radio product OFF immediately if you have any reason to suspect that interference is taking place.

Hearing Aids

Some digital wireless radio products may interfere with some hearing aids. In the event of such interference, you may want to consult your hearing aid manufacturer to discuss alternatives.

Other Medical Devices

If you use any other personal medical device, consult the manufacturer of your device to determine if it is adequately shielded from external RF energy. Your physician may be able to assist you in obtaining this information.

Use While Driving

Check the laws and regulations on the use of radio products in the area where you drive. Always obey them. When using the radio product while driving, please:

- Give full attention to driving and to the road.
- Use hands-free operation, if available.
- Pull off the road and park before making or answering a call if driving conditions so require.

SPECIFIC ABSORPTION RATE (SAR) INFORMATION

Your wireless handheld portable telephone is a low power radio transmitter and receiver. When it is ON, it receives and also sends out radio frequency (RF) signals. In August 1996, the Federal Communications Commissions (FCC) adopted RF exposure guidelines with safety levels for hand-held wireless phones. Those guidelines are consistent with the safety standards previously set by both U.S. and international standards bodies:

- ANSI C95.1 (1992) American National Standards Institute
- NCRP - Report 86 (1986) National Council on Radiation Protection and Measurements
- ICNIRP (1996) International Commission on Non-Ionizing Radiation Protection;
- DHWC - Safety Code 6 Department of Health and Welfare Canada

Those standards were developed by independent scientific organizations through periodic and thorough evaluation of scientific studies. The standards include a substantial safety margin designed to assure the safety of all persons, regardless of age and health. The exposure standard for wireless mobile phones employs a unit of measurement known as the Specific Absorption Rate, or SAR. The SAR limit set by the FCC is 1.6W/kg.² Tests for SAR are conducted using standard operating positions specified by the FCC with the phone transmitting at its highest certified power level in all tested frequency bands. Although the SAR is determined at the highest certified power level, the actual SAR level of the phone while operating can be well below the maximum value. This is because the phone is designed to operate at multiple power levels so as to use only the power required to reach the network. In general, the closer you are to a wireless base station antenna, the lower the power output. Before a phone model is available for sale to the public, it must be tested and certified to the FCC that it does not exceed the limit established by the government-adopted requirement for safe exposure. The tests are performed in positions and locations (e.g., at the ear and worn on the body) as required by the FCC for each model. While there may be differences between the SAR levels of various phones and at various positions, they all meet the government requirement for safe exposure. The FCC has granted an Equipment Authorization for this model phone with all reported SAR levels evaluated as in compliance with the FCC RF emission guidelines. SAR information on this model phone is on file with the FCC and can be found under the Display Grant section of <http://www.fcc.gov/oet/fccid> after searching on FCC ID IYGSNP2400 or FCC ID IYGRNP2400. Additional information on Specific Absorption Rates (SAR) can be found on the Cellular Telecommunications Industry Association (CTIA) web-site at <http://www.wow-com.com>.

The only authorized headsets that may be utilized with the SNP2400 and the RNP2400 are those obtainable from SpectraLink or it's reseller partners.

The measured SAR of the SNP2400 Wireless Telephone is
0.61W/kg @ 2462 MHz (head) 0.0379W/kg @ 2412 MHz (body).

The measured SAR of the RNP2400 Wireless Telephone is
0.166W/kg @ 2462 MHz (head) 0.0162W/kg @ 2412 MHz (body).

Handset Operation Normal Position:

Hold the handset as you would any other telephone, with the earpiece to your ear and speak into the microphone. The internal antenna is then positioned properly.

² In the United States and Canada, the SAR limit for mobile phones used by the public is 1.6 watts/kg (W/kg) averaged over one gram of tissue. The standard incorporates a substantial margin of safety to give additional protection for the public and to account for any variations in measurements.

Free Manuals Download Website

<http://myh66.com>

<http://usermanuals.us>

<http://www.somanuals.com>

<http://www.4manuals.cc>

<http://www.manual-lib.com>

<http://www.404manual.com>

<http://www.luxmanual.com>

<http://aubethermostatmanual.com>

Golf course search by state

<http://golfingnear.com>

Email search by domain

<http://emailbydomain.com>

Auto manuals search

<http://auto.somanuals.com>

TV manuals search

<http://tv.somanuals.com>