

POWERCLASS™

PC4200 / PC4400 / PC4800 / PC6600 OWNER'S MANUAL



100%

CONTENTS

(click on a topic to view)

- CONGRATULATIONS
- FEATURES / SPECIFICATIONS
- FEATURES / SPECIFICATIONS (cont.)
- INSTALLATION
- WIRING
- WIRING (continued)
- POWER / GROUND
- POWER, GROUND, and REMOTE
- SPEAKER WIRING
- BRIDGING
- REAR ENDPLATE DIAGRAMS
- FRONT ENDPLATE PC4200 / PC4400
- FRONT ENDPLATE PC4800
- FRONT ENDPLATE PC6600
- INPUTS
- QBASS / QBASS REMOTE
- CROSSOVER OPERATION
- FREQUENCY DETENT CHARTS
- INPUT COMBINE / GAIN
- THERMAL MANAGEMENT
- TROUBLE SHOOTING
- SYSTEM DIAGRAM ONE / TWO
- SYSTEM DIAGRAM THREE
- SYSTEM DIAGRAM FOUR
- SYSTEM DIAGRAM FIVE
- SYSTEM DIAGRAM SIX
- BLOCK DIAGRAM 4200 / 4400
- BLOCK DIAGRAM 4800
- BLOCK DIAGRAM 6600
- WARRANTY

Congratulations and thank you.....

for choosing *PrecisionPower* audio equipment. At *PrecisionPower* we proudly design, engineer and manufacture audio products at our facility in Phoenix, Arizona. Our award winning engineering team utilizes innovative technology to consistently deliver *Absolutely State of the Art™* performance, sound quality, reliability, and value. This *PrecisionPower* product reflects our commitment to offer you unparalleled versatility and quality for years of dependable service and listening enjoyment.

Service



Do not attempt to service *PrecisionPower* products yourself. Performing exploratory surgery on your audio equipment yourself will void the warranty. Many parts of your *PrecisionPower* gear are custom built to our specifications. Our factory parts are not made available to anyone else nor are they for sale. Our goal is to make sure that your *PrecisionPower* product will always sound as good as the day it was purchased. Contact your authorized *PrecisionPower* dealer about obtaining any warranty service through *PrecisionPower*.(See Warranty inside back cover)

FOR YOUR RECORDS:

M o d e l _____

Serial Number _____

Purchase Date _____

Caution!



The extended use of a high powered audio system may result in hearing loss or damage. While *PrecisionPower* systems are capable of "Concert Level" volumes with incredible accuracy, they are also designed for you to enjoy at more reasonable levels all of the sonic subtleties created by musicians. Please observe all local sound ordinances.

FEATURES / SPECIFICATIONS

Your new amplifier incorporates some or all of the following features:

- Adaptive MOSFET Switching Power Supply
- Fully Complementary Darlington Output Stage
- AP III** Protection Circuitry (PC4200, PC4400, PC6800)
- AM IV** Protection Circuitry (PC4800)
- QBASS™** Bass Boost (PC4200, PC4400)
- QBASS PLUS™** (PC4800, PC6600)
- QBASS REMOTE™** Compatible (PC4800, PC6600)
- PowerLock** Speaker and Power Wire Connectors
- Detented, Variable 3-way Internal Crossover
- Non-Fading Sub Channel
- Balanced Differential Input Stage
- High Voltage Input Capability with Input Attenuation Switch
- Gold Plated RCA Input and Output Connectors
- Mixed Mono/Stereo Operation
- 3 Year Warranty when installed by an Authorized *PrecisionPower* Dealer
- Completely Designed And Handcrafted In The USA

Specifications



Power Bandwidth:	4.5 Hz - 100 kHz
Total Harmonic Distortion:	0.02 %
Input Topology:	Differential
Input Sensitivity:	150mv - 12 volts RMS
Input Impedance:	10k Ohms
Load Impedance (stereo)	2 - 8 Ohms
Load Impedance (bridge)	4 - 8 Ohms
Supply Voltage	11 - 15 volts
Damping Factor	>500
Slew Rate	>50 V/μS
Idle Current:	PC4200 / PC4400 - 1.5 Amps PC4800 - 3.0 Amps PC6600 - 2.0 Amps

Continuous Output Power



PC4200

- 25 WRMS x 4 @ 4Ω per channel
- 50 WRMS x 4 @ 2Ω per channel
- 100 WRMS x 2 @ 4Ω bridged

PC4400

- 50 WRMS x 4 @ 4Ω per channel
- 100 WRMS x 4 @ 2Ω per channel
- 200 WRMS x 2 @ 4Ω bridged

PC6600

- 50 WRMS x 6 @ 4Ω per channel
- 100 WRMS x 6 @ 2Ω per channel
- 200 WRMS x 3 @ 4Ω bridged

PC4800

- 100 WRMS x 4 @ 4Ω per channel
- 200 WRMS x 4 @ 2Ω per channel
- 400 WRMS x 2 @ 4Ω bridged

FEATURES / SPECIFICATIONS

QBASS™ and QBASS PLUS™ Specifications



QBASS™ (PC 4200, PC4400, and PC 6600)

Up to 12dB of Boost centered at 40Hz, with a Q-Factor of 2.

QBASS PLUS™ (PC 4800)

Up to 18dB of Boost with selectable center frequency at 30Hz, 36Hz, 44Hz or 60Hz. Selectable Q of 2 or 4. Optional remote mounted Boost Control.

Optional QBASS REMOTE™ (PC 4800)

This boost control can be mounted in the dash and will supersede the boost control on the amplifier endplate.

Optional QPORT™ expansion module allows one QBASS REMOTE™ to operate multiple amplifiers. Each QPORT™ has outputs for four amplifiers as well as another QPORT™ for greater expansion. See your authorized PrecisionPower dealer for more information!



Crossover Specifications



PC4200 / PC4400

Front - 12dB/Octave, Detented High Pass 20-5kHz

Rear - 12dB/Octave, Selectable Detented High or Low Pass 20-5kHz

RCA Out-Summed Mono 24dB/Octave, Linkwitz-Riley Low Pass, 90Hz

QBASS™ on Rear Channel

PC4800

Front - 12dB/Octave, Detented High Pass 20-5kHz

Rear - Choice of 12dB/Octave Detented High Pass 20-5kHz, or

Summed Mono 24dB/Octave, Linkwitz-Riley Detented Low Pass 44-315Hz

RCA Outputs will be the opposite of your Rear Crossover choice.

QBASS PLUS™ on Rear Channel

PC6600

Front - 12dB/Octave, Detented High Pass 20-5kHz

Rear - 12dB/Octave, Detented High Pass 20-5kHz

Sub-Summed Stereo 24dB/Octave, Linkwitz-Riley Low Pass at 90Hz

QBASS PLUS™ on Sub Channel.

Dimensions



PC4200

Length - 12.22"

Height - 2.25"

Width - 8.9"

PC4400

Length - 13.72"

Height - 2.25"

Width - 8.9"

PC6600

Length - 19.72"

Height - 2.25"

Width - 8.9"

PC4800

Length - 23.72"

Height - 2.25"

Width - 8.9"

INSTALLATION

Tools/Parts needed for Installation (not supplied)



- Small flat blade screwdriver
- Phillips Screwdriver (#2 or medium sized)
- Wire cutters
- Wire strippers
- 4 - #6 round head screws, and 1 - #8 sheet metal screw (or nut, bolt, and star washer)
- 2 - Ring connectors (large enough to accommodate your method of grounding)
- In-line fuse or circuit breaker - see fuse chart below
- Power and ground wire - see Power Wire Calculator on page 4
- Speaker wire - 16 gauge or larger
- Grommets (sized to work with the power wire you plan to use in your installation)
- Tube of silicone sealant

Fuse requirements



Amplifier	Maximum Fuse Rating
<i>PC4200</i>	40 Amp
<i>PC4400</i>	60 Amp
<i>PC4800</i>	80 Amp
<i>PC6600</i>	80 Amp

You will need to install an in-line fuse or circuit breaker in the power wire within 18" of the battery. This fuse or circuit breaker is to protect your vehicle from fire in case the power wire shorts to the vehicle body. If you are only using one amplifier, use the fuse rating indicated in this chart. If you are using more than one amplifier, add up the fuse ratings for all the amplifiers. This sum is the rating for your main fuse or circuit breaker. Use a power distribution block or fuse near your amplifiers with the appropriate fuse for each individual power wire.

WIRING

The following is a basic formula to be used as a guide to determine current draw. A 50% amplifier efficiency rating is used as an average. Your new **POWERCLASS™** amplifier is more efficient, other amplifiers will probably be less. This formula is to be used as a guideline. Using wire of a larger gauge can only improve the current transfer of your system. Do not use smaller gauge wire.

Total RMS output x 2 = Total Input Wattage

$$\frac{\text{Total Input Wattage}}{\text{Supply Voltage}} = \text{Current Draw (in Amps)}$$

Example: A **POWERCLASS™** 4400 amplifier has four channels at 50 watts RMS per channel into 4 Ohms (50 x 4 = 200). You would use the formula in the following way:

$$200W \times 2 = 400W$$

$$\frac{400W}{12V} = 33.3A \text{ Total current draw.}$$

If the same amplifier is driven into a 2 Ohm stereo or 4 Ohm mono load, double it's 4 Ohm RMS rating. All **POWERCLASS™** amplifiers will effectively double their power at this load.

$$100W \times 4 \times 2 = 800W$$

$$\frac{800W}{12V} = 66.6A \text{ Total current draw.}$$

If you are using more than one amplifier, add up the total current draw for all of them and choose the appropriate gauge based on the grand total.

Power Wire Calculator



Recommended MINIMUM Gauge

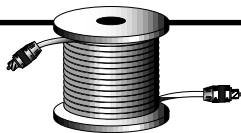

Total Current Draw (in Amps)	Length Of Wire To Be Run							
	Up to 4ft.	4 to 7ft.	7 to 10ft.	10 to 13ft.	13 to 16ft.	16 to 19ft.	19 to 22ft.	22 to 28ft.
0-20	14	12	12	10	10	8	8	8
20-35	12	10	8	8	6	6	6	4
35-50	10	8	8	6	6	4	4	4
50-65	8	8	6	4	4	4	4	2
65-85	6	6	4	4	2	2	2	0
85-105	6	6	4	2	2	2	2	0
105-125	4	4	4	2	2	0	0	0
125-150	2	2	2	2	0	0	0	00

NOTE: The ground wire should be the same gauge as the power wire.

WIRING

Before beginning, disconnect the negative (-) terminal of the battery prior to working on the positive (+) terminal to prevent a short to ground. This is important, unless you want to spend the rest of your life with a nickname like "Sparky," or "Smokey." Reconnect the negative terminal only after all connections have been made.

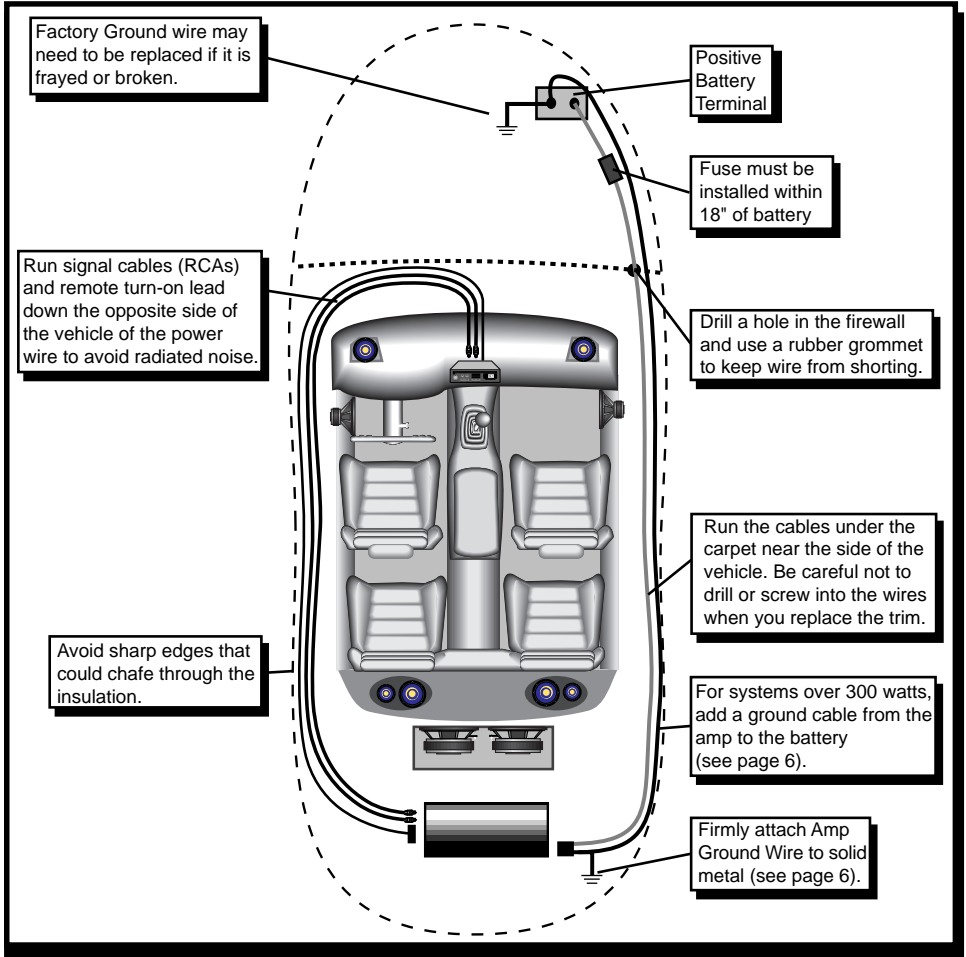

Warning!

Fuse must be installed within 18" of battery

Grounding



Locate an area near the amplifier(s) that is metal and clean an area about the size of a quarter to bare metal. Inspect the area around and underneath to be sure you won't drill into wires, brake or fuel lines.

Drill a pilot hole in the middle of this area. Terminate the ground wire with a ring connector and attach it to the bare metal using a #8 sheet metal screw and washer or preferably, a bolt, nut and a star washer (not supplied). We suggest crimping and soldering this connection. After the connection is complete, coat the area (on both sides) with silicone or some similar material to prevent rust from developing on the bare metal.

If your grand total current draw is over 50 amps (or total output power is over 300 watts), you should run a ground wire beside your power wire from the battery to the amplifier(s) in addition to your regular ground wire. Keep the ground and power wires as close together as possible, and use the same gauge wire for both. This will ensure that you have a good ground path, and may eliminate such potential problems as engine noise and overheated amplifiers.

Charging System Considerations



If your grand total current draw is over 100 amps (or total output power is over 600 watts), you are probably exceeding the capability of your charging system. Dimming lights and fluctuating voltage are solid indicators that you need to upgrade your alternator, battery (or go to multiple batteries), or both.

Keep in mind that your amplifiers simply convert electrical energy to acoustical energy, and any electrical deficiency will compromise the performance of your sound system.

For more information about charging system upgrades, see your local authorized *PrecisionPower* Dealer or call the *PrecisionPower* technical support office at **1-800-62POWER**.

POWER / GROUND and REMOTE

Once you have run both the power and ground wires, it's time to connect the cables to the amplifier. Cut off excess wire and, using wire strippers, strip the ends of the power and ground cables approximately 1/4 inch. Locate the **PowerLock** power and ground connector (supplied). With a small flat bladed screw driver, loosen the screws before attempting to insert the cables. Insert the wires into the appropriate hole, and tighten the screws. Once the wires are secure, the **PowerLock** may be plugged into the amplifier. The Power/Ground **PowerLock** will accommodate 6 gauge wire for the **PC4200 / PC4400**, and 4 gauge wire for the **PC4800** and **PC6600**.

Power/Ground **PowerLock**

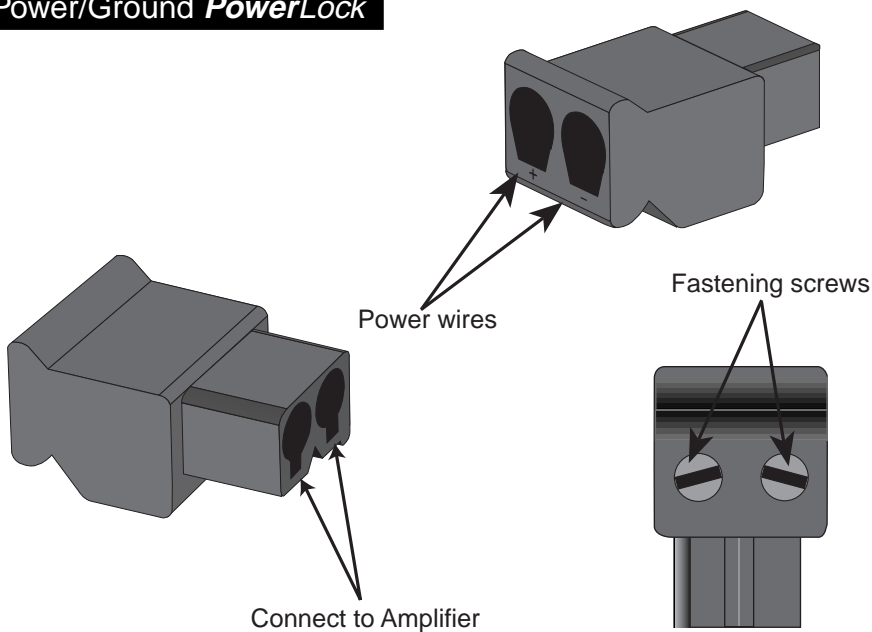

Remote turn-on

 Your head unit should have a lead marked 'remote' or 'power antenna' which will be used to turn on your amplifier. Extend this lead through your vehicle along with your RCA signal wires. Strip 1/4 inch of insulation off the wire and insert the end into the center terminal of the 5-pin speaker/remote **PowerLock**.

SPEAKER WIRING

Using 16 gauge or larger, run the speaker wires from the amplifier location through the vehicle to the speakers. Observe the same precautions for routing these wires that you followed for running the power and remote turn-on wires. Cut off excess and, using wire strippers, strip 1/4 inch of insulation. Locate the speaker/remote turn-on **PowerLock** connector. Loosen the four outer screws on the underside of the connector and insert the front (**PC4200**, **PC4400** and **PC4800**) or sub (**PC6600**) speaker leads into the end. Check to be sure you've maintained proper polarity before securing each wire.

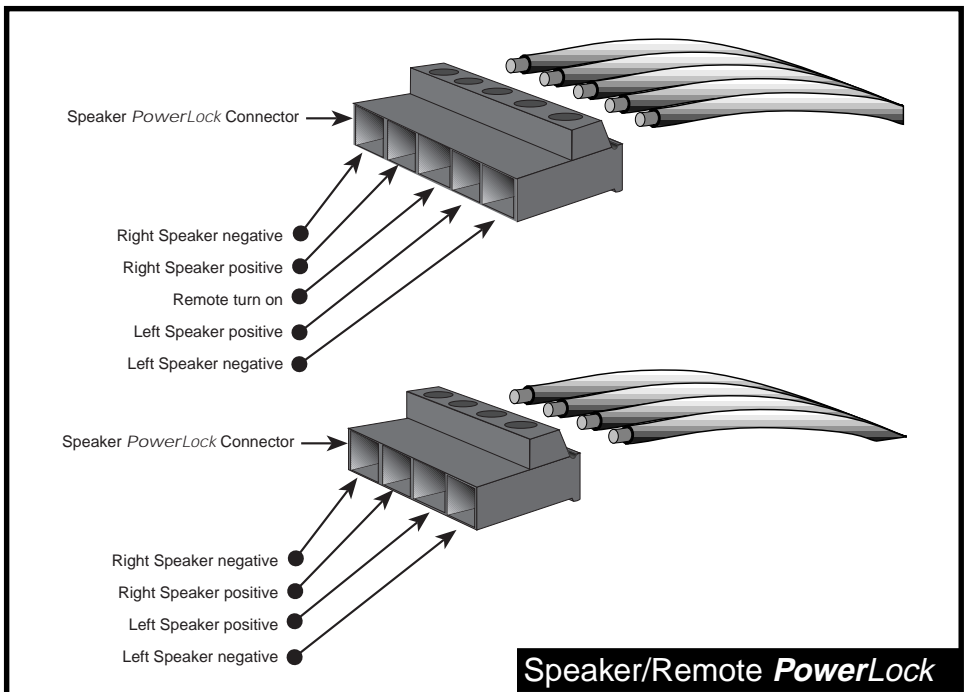

For the rear channels, locate the four terminal speaker **PowerLock** connector. (For PC650, the front channel also uses a four terminal **PowerLock** connector.) On 4 and 6 channel PowerClass Amplifiers, all speaker **PowerLocks** plug into the amplifier with the screws facing up. Loosen the screws on the top of the blocks and insert the stripped ends of the speaker wires into the end. Double check polarity, secure each wire by tightening the screws, and plug the **PowerLock** connector into the amplifier with the screws on top.

Bridging



Any or all pairs of channels (front, rear or sub) on your **POWERCLASS™** multi channel amplifier are capable of being bridged into a 4 ohm mono output without switches or bridging modules. This feature permits the creation of a mono channel for a subwoofer or center channel.

Deriving the mono channel is accomplished by using the left channel positive wire of the pair as the positive speaker wire and the right channel negative wire as the negative speaker wire. You should always be working with the wires of a single **PowerLock** speaker connector when bridging a pair of channels.

NOTE: It is important that a minimum 4 ohm impedance is observed. If the impedance drops significantly below 4 ohms while the amplifier is wired in the bridged configuration, the amplifier's protection circuitry may engage.

Mixed Mono Output



The ability to run stereo speakers while simultaneously running a mono output from the same channel pair is accomplished by running the stereo speakers normally and tapping into the appropriate wires for the "mixed mono" channel (left channel positive for the positive speaker wire and right channel negative for the negative speaker wire). Total speaker impedance should be no lower than 2 ohms on the stereo channels and 4 ohms on the mono channel.

NOTE: Passive crossovers must be used for "mixed mono" operation. Choose a low pass crossover around 100Hz for your subwoofer, then choose a high pass crossover for your stereo channels. The high pass crossover must be at the same or slightly higher frequency than the low pass crossover to maintain the correct impedance. See your **PrecisionPower** dealer or call **1-800-62POWER** for more information about passive crossovers.

ENDPLATE DIAGRAMS

POWER / GROUND / QBASS™

PC4200

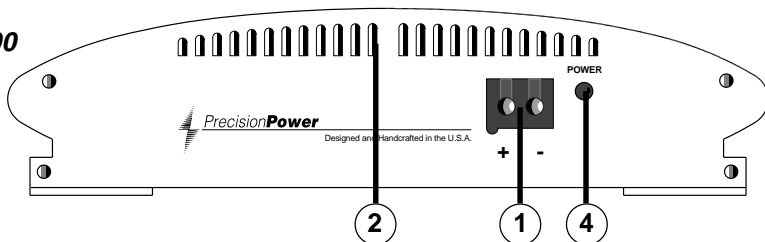

PC4400

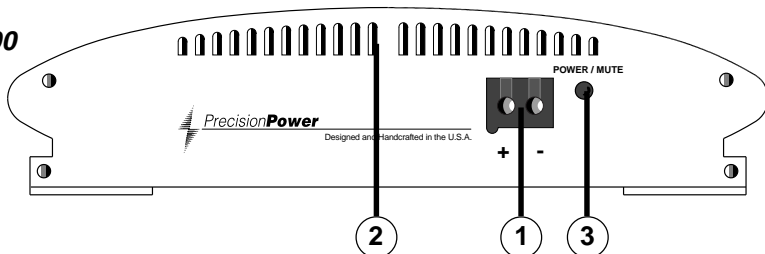

PC4800

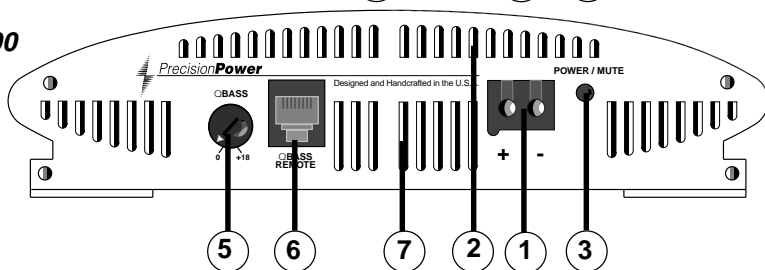

PC6600

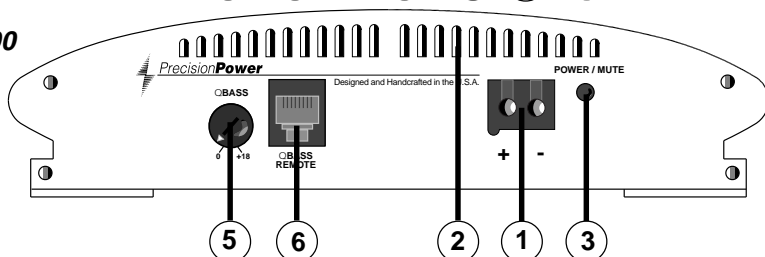

1. POWER / GROUND *PowerLock*

After you have securely connected your power and ground wires, plug in the Power / Ground **PowerLock** connector here.

2. COOLING VENTS (see page 18).

3. POWER / MUTE indicator

A green light indicates that the amplifier is on, a red light indicates that the amplifiers muting circuits are engaged.

4. POWER indicator

A green light indicates that the amplifier is on.

5. QBASS™ Level

Turn this control clockwise to boost the **QBASS PLUS™** circuit by up to 18dB.

6. QBASS REMOTE™ plug in

Plug in the data cable from the optional **QBASS REMOTE™** dash mount level control here. (This will bypass the amplifier's on board **QBASS™** control)

7. FORCED AIR INTAKE VENTS (see page 18 and 19).

ENDPLATE DIAGRAM

4200 / 4400

1. REAR HP/LP switch

This switch is used to select whether the amplifier will provide a high pass (switch in) or low pass (switch out) signal to the rear speakers. (see page 16).

2. REAR GAIN

Use this control to match the output level of the head unit to the rear channel of the amplifier (see page 18).

3. QBASS™ Control

Rotate clockwise to boost up to 12dB at 40Hz (see page 15).

4. FRONT GAIN

Use this control to match the output level of the head unit to the front channel of the amplifier (see page 18).

5. COOLING VENTS (see page 18).

6. SPEAKER/REMOTE CONNECTOR

After connecting remote and speaker wires, plug in the **PowerLock** connectors here (see pages 7-9).

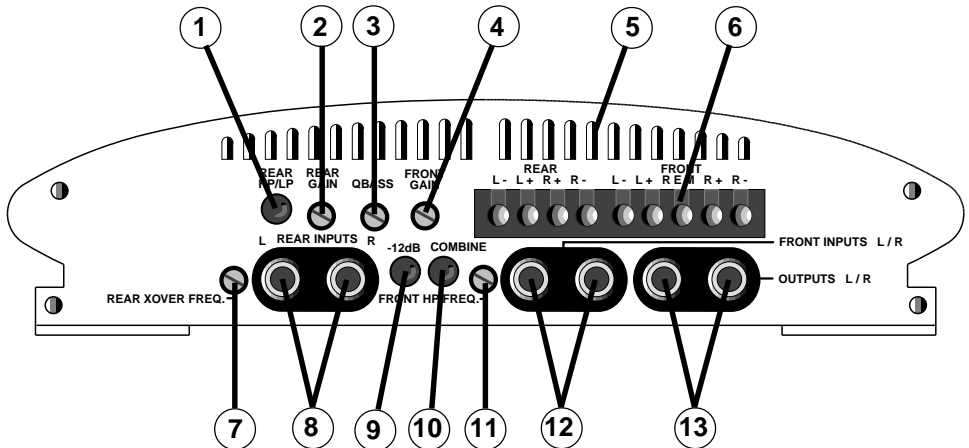

7. REAR XOVER FREQ.

Use this control to adjust the rear crossover frequency from 20Hz to 5kHz (see page 16).

8. REAR INPUTS

Plug in the rear RCA leads from your head unit here (see page 14).

9. -12dB

For use with high level inputs (4V up to 12V). Push this switch in to attenuate the input by 12dB (see page 14).

10. COMBINE

Push this switch in to connect the rear channels to the front inputs (see page 18).

11. FRONT XOVER FREQ.

Use this control to adjust the front crossover frequency from 20Hz to 5kHz (see page 16).

12. FRONT INPUTS

Plug in the front RCA leads from your head unit here (see page 14).

13. L/R OUTPUTS

Left and Right RCA outputs provide summed mono low pass signal to another amplifier.

ENDPLATE DIAGRAM

4800

1. REAR LP FREQ.

Use this control to adjust the rear low pass crossover frequency from 44Hz to 315Hz (see page 16).

2. REAR GAIN

Use this control to match the output level of the head unit to the rear channel of the amplifier (see page 18).

3. FRONT GAIN

Use this control to match the output level of the head unit to the front channel of the amplifier (see page 18).

4. QBASS 1

Use this switch with the **QBASS 2** to program the **QBASS PLUS™** circuit. (see page 15).

5. QBASS 2

Use this switch with the **QBASS 1** to program the **QBASS PLUS™** circuit. (see page 15).

6. Q SELECT 4/2

Push this button in for a Q setting of 4 and out for a setting of 2.

7. FORCED AIR EXHAUST VENTS (see page 18 and 19).

8. SPEAKER/REMOTE CONNECTOR

After connecting remote and speaker wires, plug in the **PowerLock** connectors here (see pages 7-9).

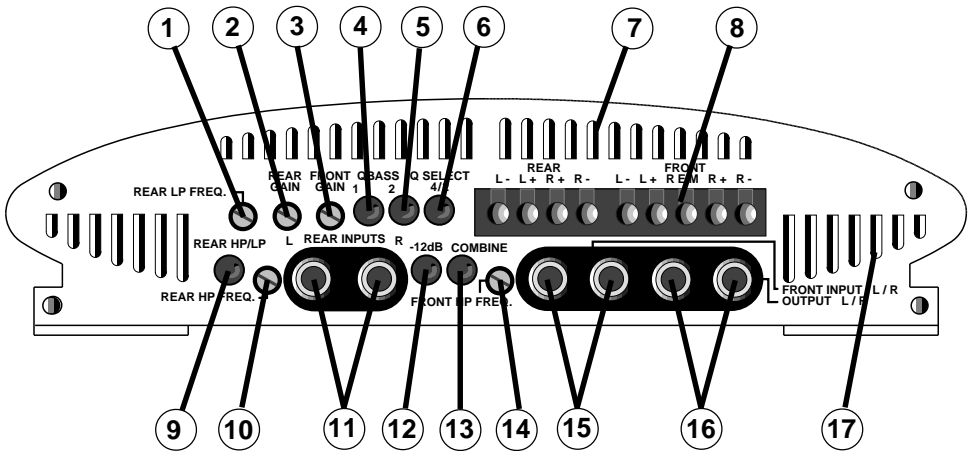

9. REAR HP/LP switch

This switch is used to select whether the amplifier will provide a high pass (switch IN) or mono low pass (switch OUT) signal to the rear speakers. (see page 16).

10. REAR HP FREQ.

Use this to adjust the rear high pass crossover frequency from 20Hz to 5kHz (see page 16).

11. REAR INPUTS

Plug in the rear RCA leads from your head unit here (see page 14).

12. -12dB

For use with high level inputs (4V up to 12V). Push this switch in to attenuate the input by 12dB (see page 14).

13. COMBINE

Push this switch in to connect the rear channels to the front inputs (see page 18).

14. FRONT HP FREQ.

Use this to adjust the rear high pass crossover frequency from 20Hz to 5kHz (see page 16).

15. FRONT INPUTS

Plug in the front RCA leads from your head unit here (see page 14).

16. OUTPUTS

Left and Right RCA outputs provide high pass or mono low pass signal to another amplifier.

17. FORCED AIR INTAKE VENTS (see page 18 and 19).

ENDPLATE DIAGRAM

6600

1. FRONT GAIN

Use this control to match the output level of the head unit to the front channel of the amplifier (see page 18).

2. REAR GAIN

Use this control to match the output level of the head unit to the rear channel of the amplifier (see page 18).

3. SUB GAIN

Use this control to match the output level of the head unit to the sub channel of the amplifier (see page 18).

4. COOLING VENTS (see page 18).

5. SPEAKER/REMOTE CONNECTOR

After connecting remote and speaker wires, plug in the **PowerLock** connectors here with the screws facing up (see pages 7-9).

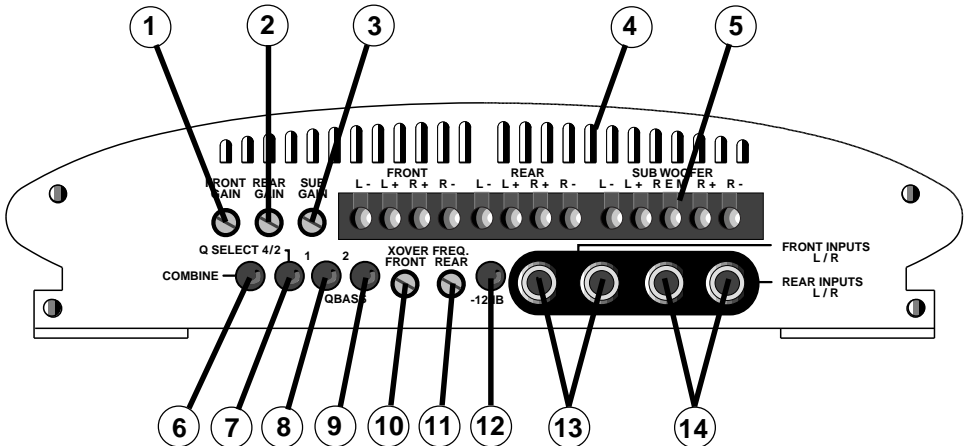

6. COMBINE

Push this switch in to connect the rear channels to the front inputs (see page 18).

7. Q SELECT 4/2

Push this button in for a Q setting of 4 and out for a setting of 2 (see page 15).

8. QBASS 1

Use this switch with the **QBASS 2** to program the **QBASS PLUS™** circuit. (see page 15).

9. QBASS 2

Use this switch with the **QBASS 1** to program the **QBASS PLUS™** circuit. (see page 15).

10. FRONT XOVER FREQ.

Use this control to adjust the front crossover frequency from 20Hz to 5kHz (see page 16).

11. REAR XOVER FREQ.

Use this control to adjust the rear crossover frequency from 20Hz to 5kHz (see page 16).

12. -12dB

For use with high level inputs (4V up to 12V). Push this switch in to attenuate the input by 12dB (see page 14).

13. FRONT INPUTS

Plug in the front RCA leads from your head unit here (see page 14).

14. REAR INPUTS

Plug in the rear RCA leads from your head unit here (see page 14).

INPUTS

There are two sets of RCA INPUTS on the front end of your amplifier. Plug the RCA cables from your head unit into the appropriate set of inputs, front and rear. If your head unit doesn't have RCA outputs don't worry. Simply add a set of RCA plugs (available at your dealer) to your front or rear set of speaker leads (see drawing below), plug them into the input jacks, and push in the -12dB switch.

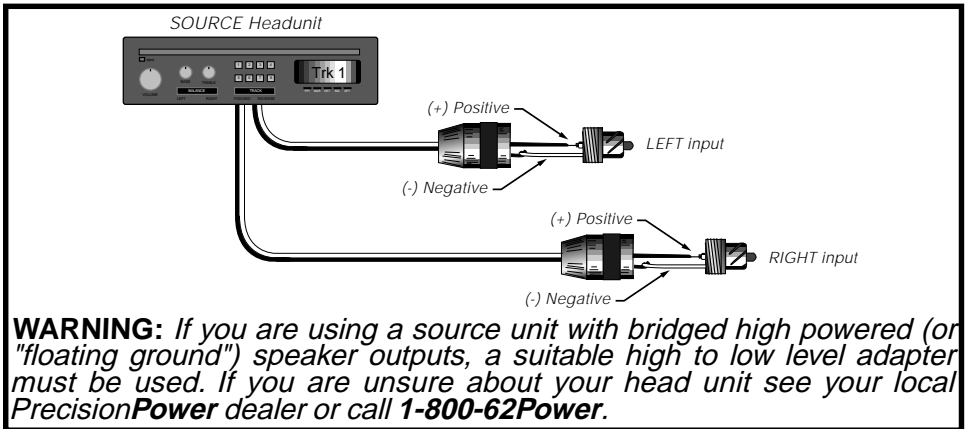

Balanced Differential Inputs



This circuitry reduces noise radiated into your signal cables by up to 40dB. This is equivalent to a noise reduction of approximately one hundred times what the noise level would be without this circuitry. It provides all the benefits of a true 'balanced' line without the need of any special cables (see diagram below). This type of input works with any conventional RCA cable.

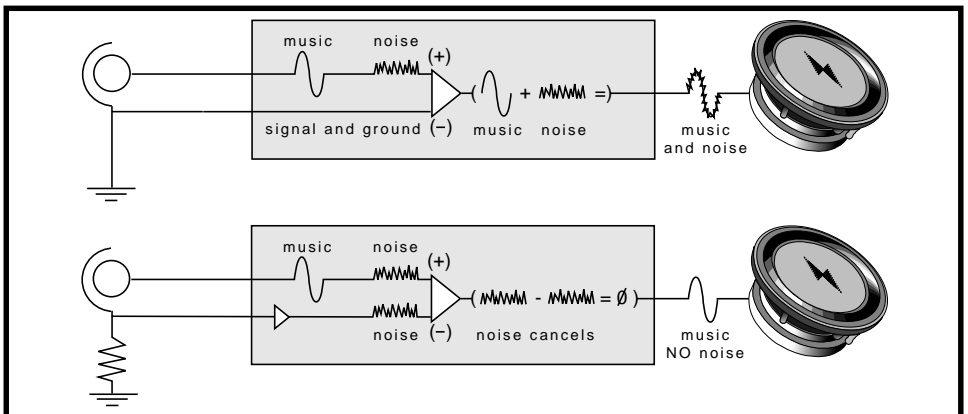

QBASS™



For extra BOOM from your system, we've developed the **QBASS™** bass control circuit. The **QBASS** control is located to the left of the speaker outputs, and allows you to add up to 12dB of boost centered at 40Hz by rotating the control clockwise.

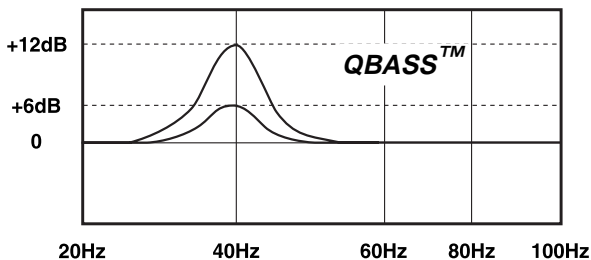

QBASS™ Is a standard feature on the **PC4200/PC4400**.

QBASSPLUS™



On **PC4800** and **PC6600** amplifiers, we've taken bass control to a higher level with **QBASS PLUS™**. The two **QBASS** switches (labeled 1 and 2) on the front end of the amplifier allow you to select one of four frequency centers - 30Hz, 36Hz, 44Hz and 60Hz. The Q SELECT switch determines the width of boosted frequencies. A 'Q' of 2 (switch out) will give you a wide boost while a 'Q' of 4 will boost a narrow range of frequencies. (See chart below.) On the rear end panel you will find the **QBASS PLUS™** level control and the plug-in for an optional **QBASS REMOTE™** level control. Adjust the level control clockwise for up to 18dB of boost at your selected frequency and Q.

QBASS PLUS™ Settings

1	2	Freq.
IN	IN	30Hz
IN	OUT	36Hz
OUT	IN	44Hz
OUT	OUT	60Hz

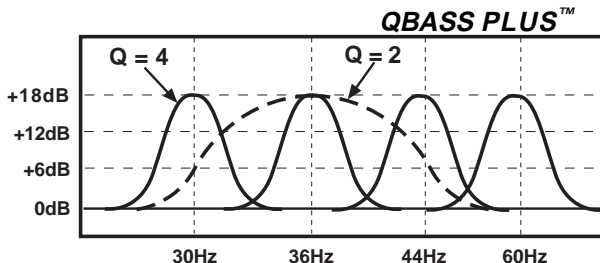

CAUTION: QBASS™ and QBASS PLUS™ should only be used in systems with strong subwoofers. 18dB is a lot of bass boost and could damage full range speakers.

CROSSOVER Operation

Your new **POWERCLASS™** amplifier has crossover circuits built-in to provide exceptional system flexibility without the added expense and installation of an outboard crossover. See the frequency detent charts on page 17 to set your amplifier's crossover.

PC4200 / PC4400



The front crossover is high pass and can be adjusted from 20Hz to 5kHz by turning the FRONT HP FREQ. control. If you need full-range, turn the control fully counterclockwise to the 20Hz position. The rear crossover can be high pass or low pass, chosen by the REAR HP/LP switch. The REAR XOVER FREQ. control determines the rear crossover frequency between 20Hz and 5kHz, 20Hz being fully counterclockwise. The RCA outputs are always mono low pass at 90Hz to send a subwoofer signal to another amplifier.

PC4800



The front crossover is high pass and can be adjusted from 20Hz to 5kHz by turning the FRONT HP FREQ. control. If you need full-range, turn the control fully counterclockwise to the 20Hz position. The rear crossover actually consists of two crossovers, one high pass and one mono low pass. The high pass section is a 12dB/octave Linkwitz-Riley type that is adjustable from 20Hz to 5kHz using the REAR HP FREQ. control. For full range operation, turn the control fully counterclockwise to the 20Hz position. The low pass section is a 24dB/octave Linkwitz-Riley type that you can adjust from 44Hz to 315Hz with the REAR LP FREQ. control. High pass or low pass to the rear channel is determined by the REAR HP/LP switch, 'OUT' being low pass and 'IN' being high pass. When you select high pass, the RCA outputs will be low pass and vice versa.

PC6600



The front and rear crossovers are both high pass, and can be adjusted from 20Hz to 5kHz using the XOVER FREQ. FRONT and REAR controls. For full range operation, turn the control fully counterclockwise to the 20Hz position. The subwoofer crossover is a 24dB/octave Linkwitz-Riley type fixed at 90Hz. See system diagrams starting on page 21 for examples!

FREQUENCY DETENT CHARTS

PC4200 / PC4400 / PC4800 / PC6600

The crossover frequency range of your new **POWERCLASS™** amplifier goes from 20Hz - 5kHz, and the controls are detented for accurate tuning. Each "click" counted from the full counterclockwise position corresponds to a specific frequency. Refer to this chart for set-up instructions.

PC4200/PC4400 - Front HP & Rear Xover Freq.

PC4800 - Front and Rear HP Freq.

DETENT PC6600 - Front and Rear Xover Freq.

1	20 Hz
2	21 Hz
3	21 Hz
4	21.5 Hz
5	22 Hz
6	23 Hz
7	24.5 Hz
8	26 Hz
9	27.5 Hz
10	30 Hz
11	32 Hz
12	35 Hz
13	39 Hz
14	43 Hz
15	49 Hz
16	56 Hz
17	64 Hz
18	73 Hz
19	80 Hz
20	88 Hz
21	100 Hz
22	114 Hz
23	134 Hz
24	160 Hz
25	196 Hz
26	260 Hz
27	320 Hz
28	368 Hz
29	432 Hz
30	496 Hz
31	608 Hz
32	752 Hz
33	864 Hz
34	1008 Hz
35	1200 Hz
36	1488 Hz
37	1952 Hz
38	2816 Hz
39	4512 Hz
40	4944 Hz
41	5000 Hz

DETENT

1	44 Hz
2	44 Hz
3	44 Hz
4	45 Hz
5	46 Hz
6	48 Hz
7	51 Hz
8	54 Hz
9	58 Hz
10	62 Hz
11	67 Hz
12	72 Hz
13	78 Hz
14	85 Hz
15	94 Hz
16	104 Hz
17	115 Hz
18	124 Hz
19	132 Hz
20	141 Hz
21	150 Hz
22	162 Hz
23	175 Hz
24	189 Hz
25	207 Hz
26	227 Hz
27	240 Hz
28	249 Hz
29	258 Hz
30	268 Hz
31	280 Hz
32	287 Hz
33	290 Hz
34	295 Hz
35	298 Hz
36	303 Hz
37	307 Hz
38	311 Hz
39	315 Hz
40	315 Hz
41	315 Hz

INPUT COMBINE and GAIN

Input Combine



Your multi channel **POWERCLASS™** amplifier can use both front and rear outputs from your head unit to maintain the ability to fade front to rear, or you can run a single set of RCAs to the front inputs and push in the COMBINE switch on the amplifier end plate to route the front signal to the rear channels as well.

Adjusting The Amplifier Input Gain



1. Adjust all amplifier input gain controls to just above minimum sensitivity (fully counterclockwise).
2. Using the cleanest source (CD), with music playing turn up the head unit until you can hear distortion. Now turn it down a bit until you cannot hear the distortion.
3. Increase the Amplifier gain (clockwise) until the onset of audible distortion. Then decrease the gain to the point just before the distortion starts. This setting minimizes background noise and prevents overload.
4. Repeat step 3 for any remaining amplifiers in the system.

Heatsink Cooling



The unique heatsink on your **POWERCLASS™** amplifier has been designed with fins on the inside of the aluminum mass. This allows for the transfer of heat from the circuitry to the heatsink fins and out through the vents in the endplates. Be sure you have ample space around the amplifier for cooling, at least 2" on all sides.

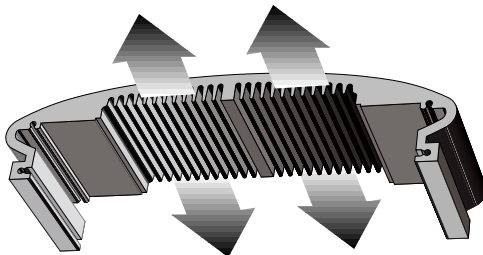

FORCED AIR THERMAL MANAGEMENT

To manage the additional heat associated with higher output capability, a thermally controlled fan has been designed into the **PC4800**. When the heatsink temperature reaches a predetermined value, the fan is activated. Cool air is drawn in through the lower intake vents on the endplate. This cool air flows below the circuit board, through the fan and across the internal fins, cooling the heatsink. The heated air is then forced out through the upper endplate exhaust vents.

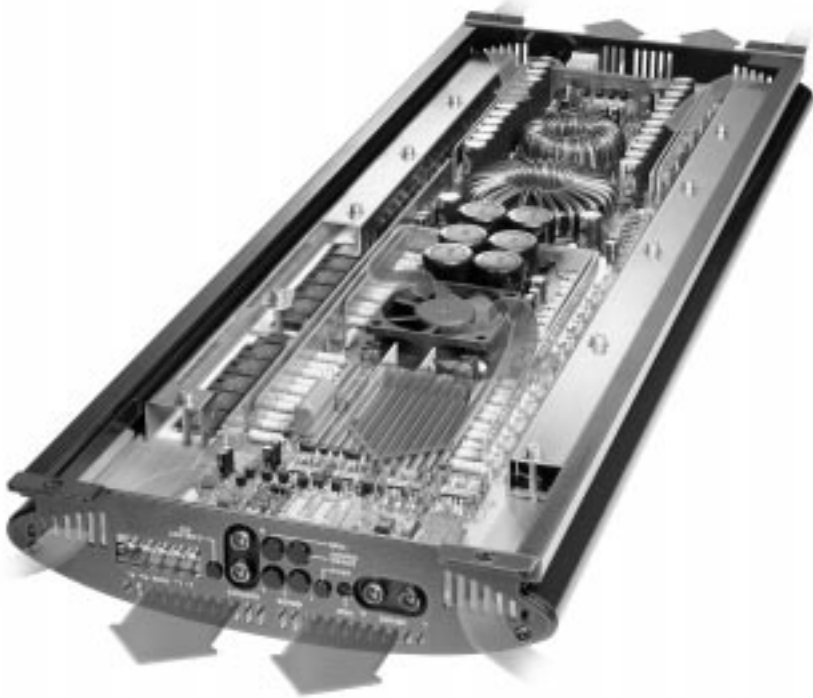

Warm Air Exhaust

Cool Air Intake

TROUBLE SHOOTING

NO SOUND

Is the LED lit?

YES

RED

Central Muting is engaged. Remote turn-on wire must have more than 8 volts to release central muting. Check Remote turn-on at the head unit. You may need to install a relay if the head unit doesn't put out sufficient voltage.

NO

Check Power and Remote turn-on wire for voltage. Make sure Ground wire is secure.

WHAT COLOR ?

GREEN

Substitute RCA inputs with another source, and connect a known good speaker to one channel.

STILL NO SOUND - See your Authorized *PrecisionPower* Dealer or Call 1-800-62**Power**

SOUND IN ONE CHANNEL ONLY

Reverse left and right speakers by unplugging the speaker connector, turning it over and plugging it back in.

SOUND IS NOW IN

OPPOSITE CHANNEL

Reverse RCA inputs

SAME CHANNEL

Problem is in the speaker or speaker wire of the silent channel.

SOUND IS NOW IN

OPPOSITE CHANNEL

Reverse RCAs at head unit

SAME CHANNEL

Problem is in the Amplifier. See your local Authorized *PrecisionPower* Dealer or call 1-800-62**POWER**.

SOUND IS NOW IN

OPPOSITE CHANNEL

Problem is in the head unit

SAME CHANNEL

Problem is in the RCA cables

AMPLIFIER SHUTS OFF

Short Circuit Protection engaged:

The amplifier will turn off and try to come back on immediately. The amplifier will cycle like this indefinitely, with "blips" of sound each time. If this is the case, check your speakers and wiring for low impedance and short circuits.

Thermal Protection engaged:

The amplifier will turn off and several minutes later will come back on. In this case, ensure that there is nothing blocking the normal convective airflow of the amplifier. No obstruction should be within 2" of the amplifier on all sides.

SYSTEM DIAGRAM

ONE / TWO

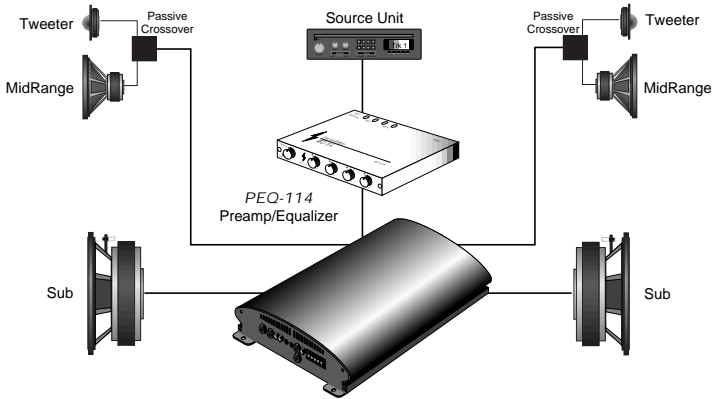

POWERCLASS™ Amplifier
PC4200, PC4400 or PC4800
Front High Pass 100Hz
Rear Low Pass 100Hz

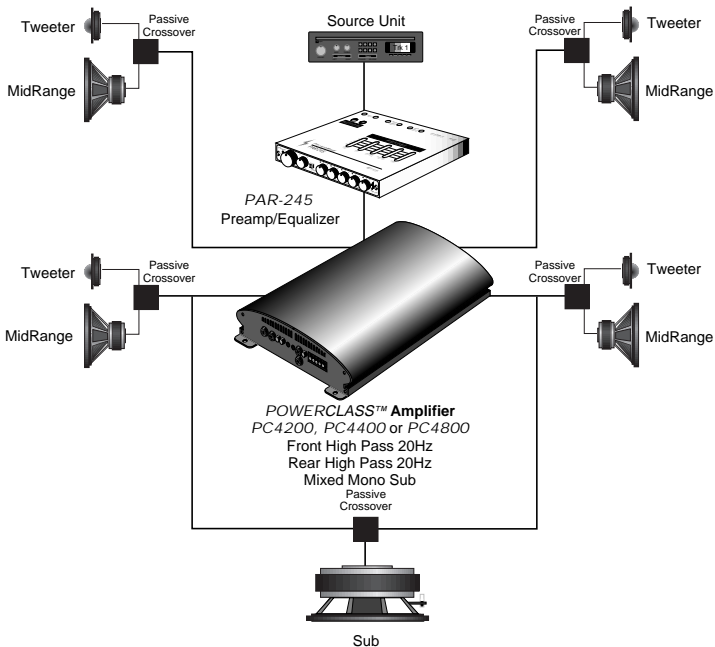

POWERCLASS™ Amplifier
PC4200, PC4400 or PC4800
Front High Pass 20Hz
Rear High Pass 20Hz
Mixed Mono Sub
Passive Crossover

SYSTEM DIAGRAM THREE

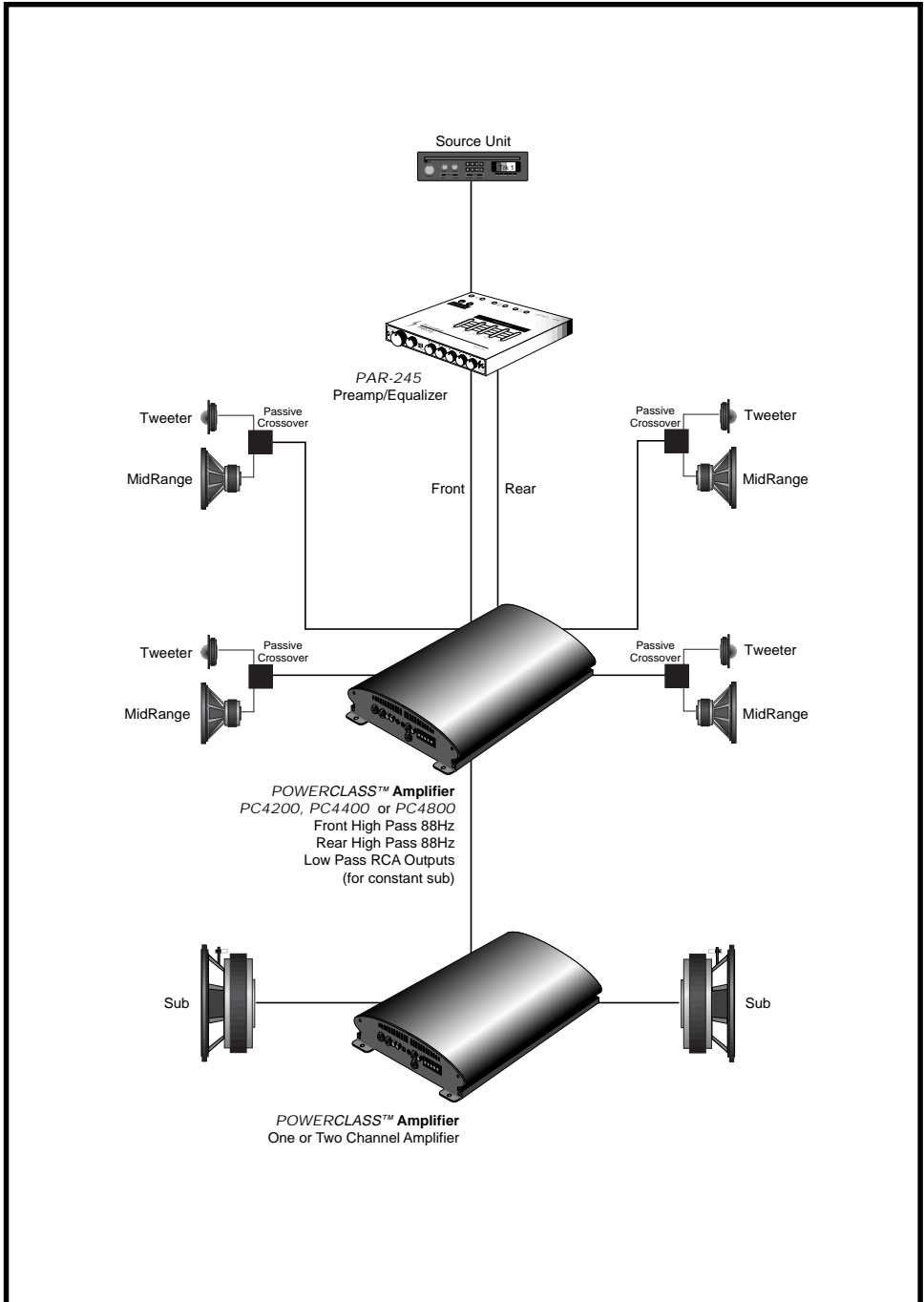

SYSTEM DIAGRAM

FOUR

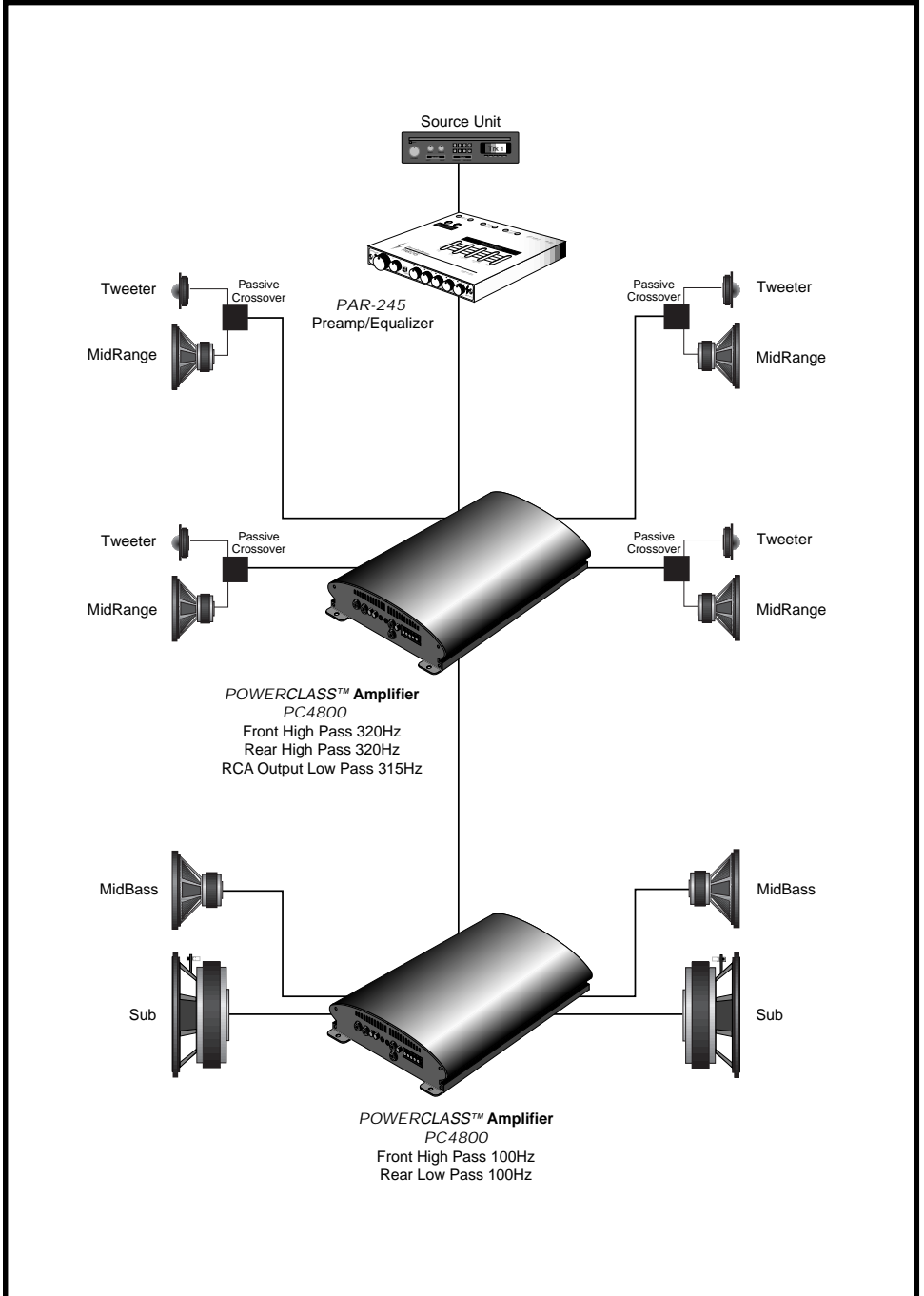

SYSTEM DIAGRAM

FIVE

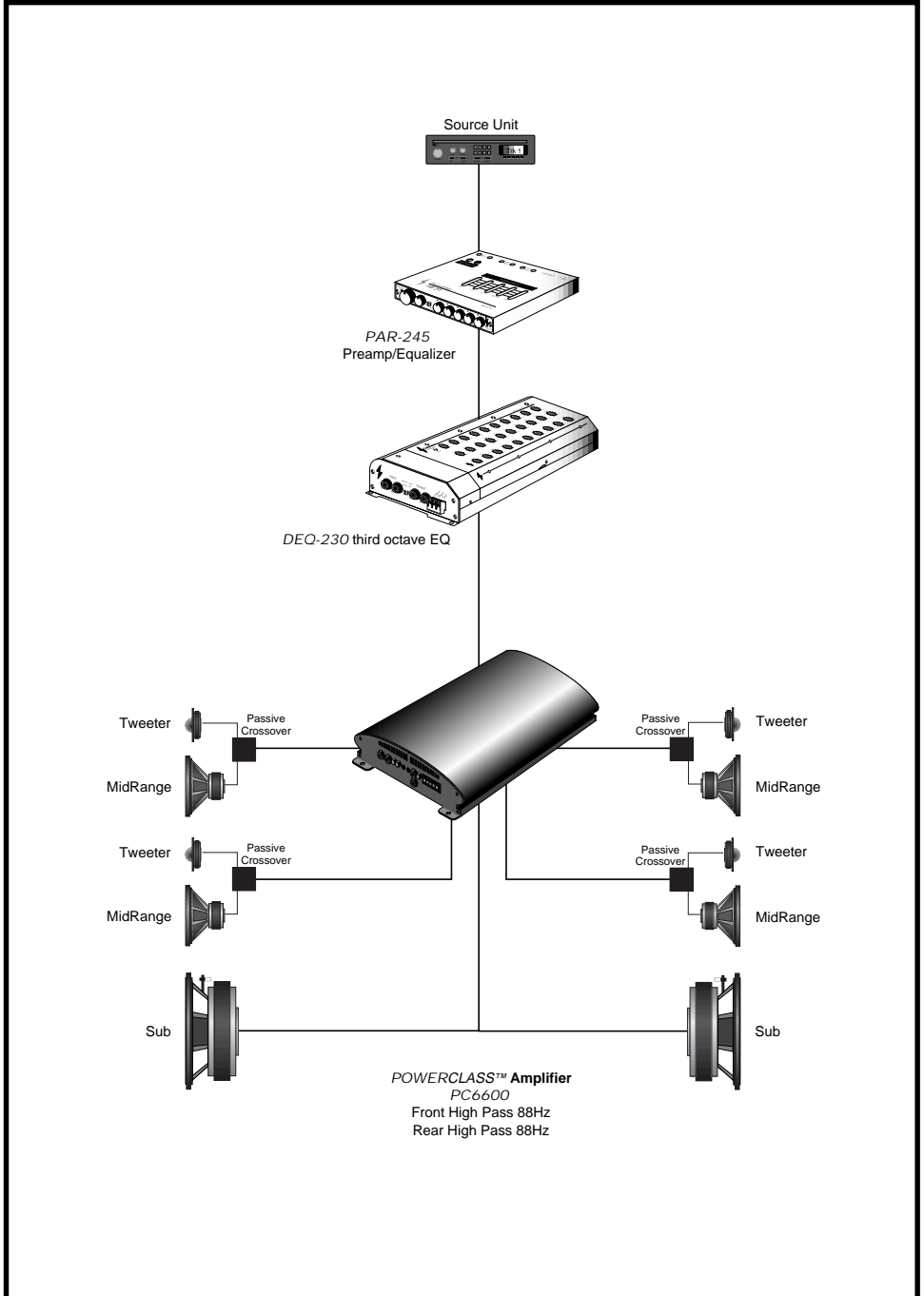

SYSTEM DIAGRAM

SIX

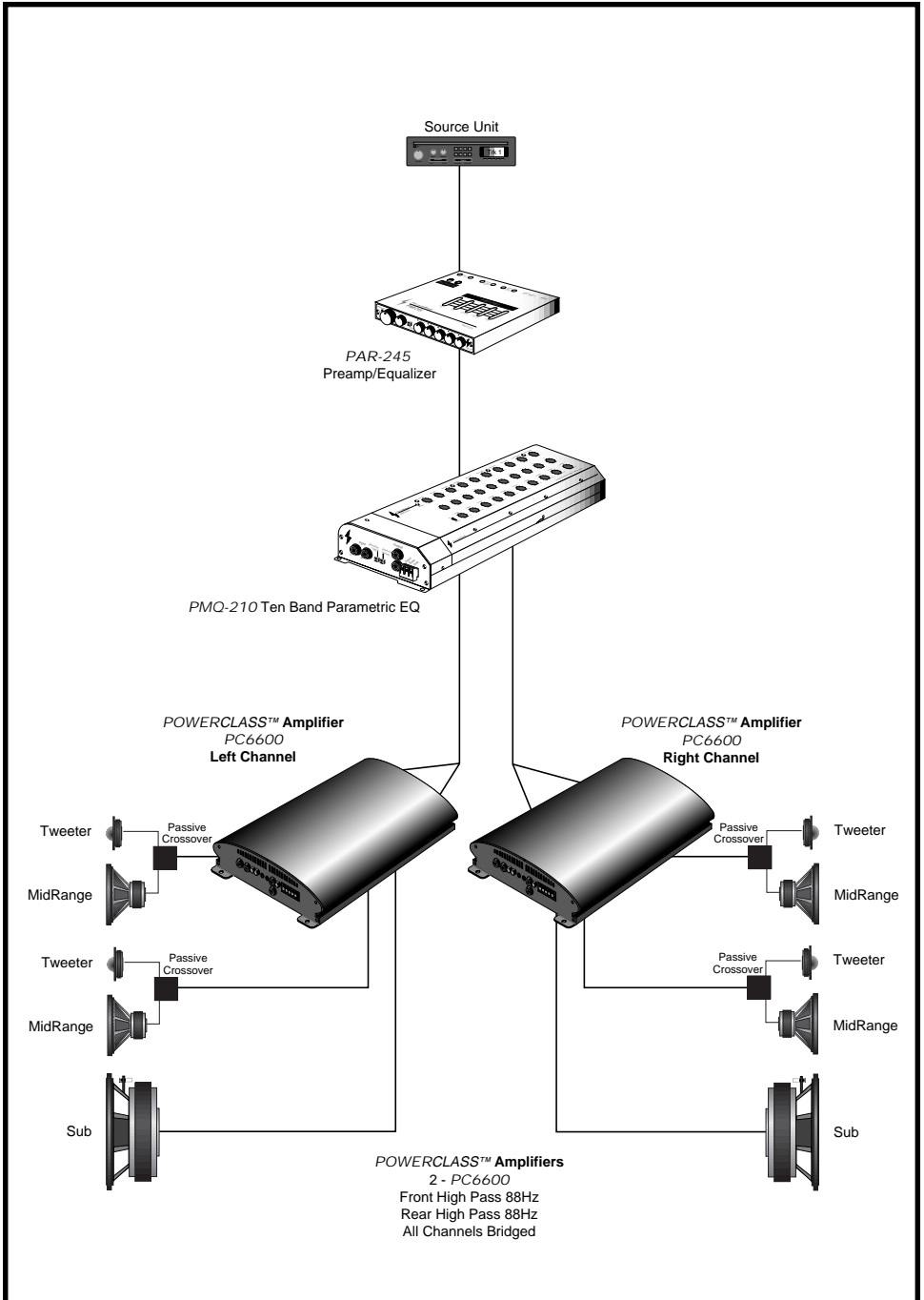

BLOCK DIAGRAM

4200/4400

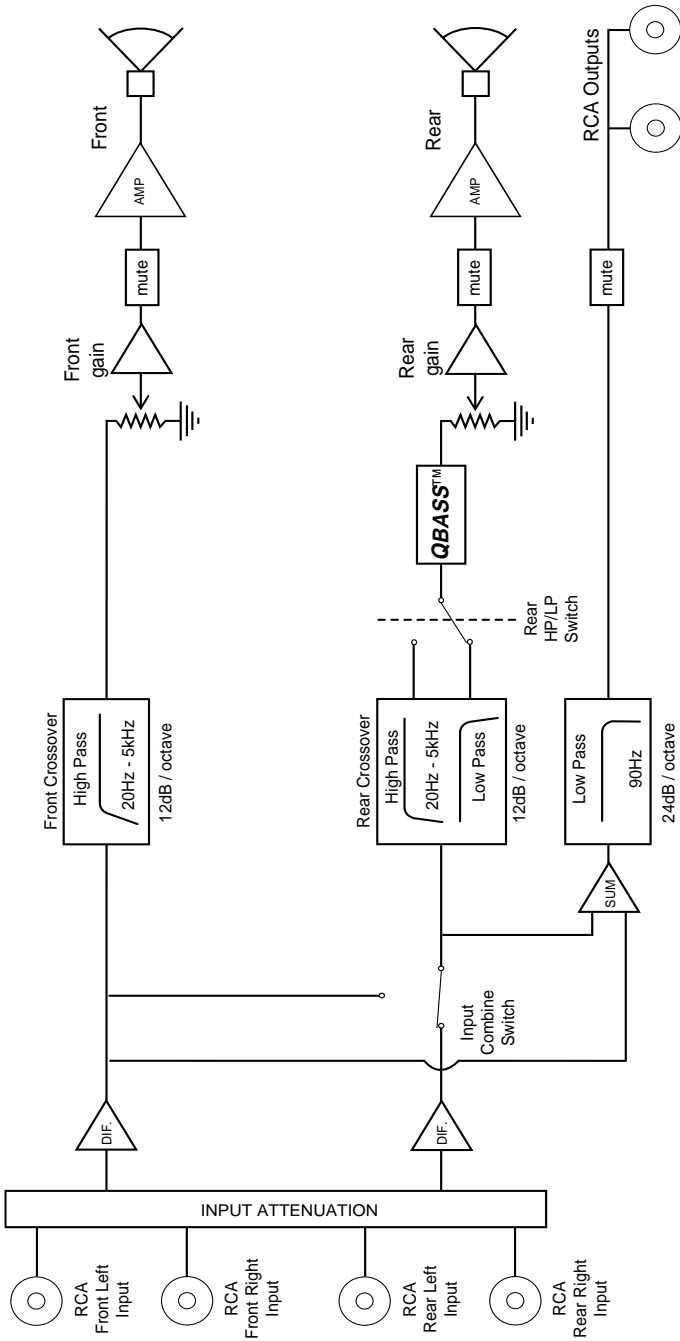

BLOCK DIAGRAM

4800

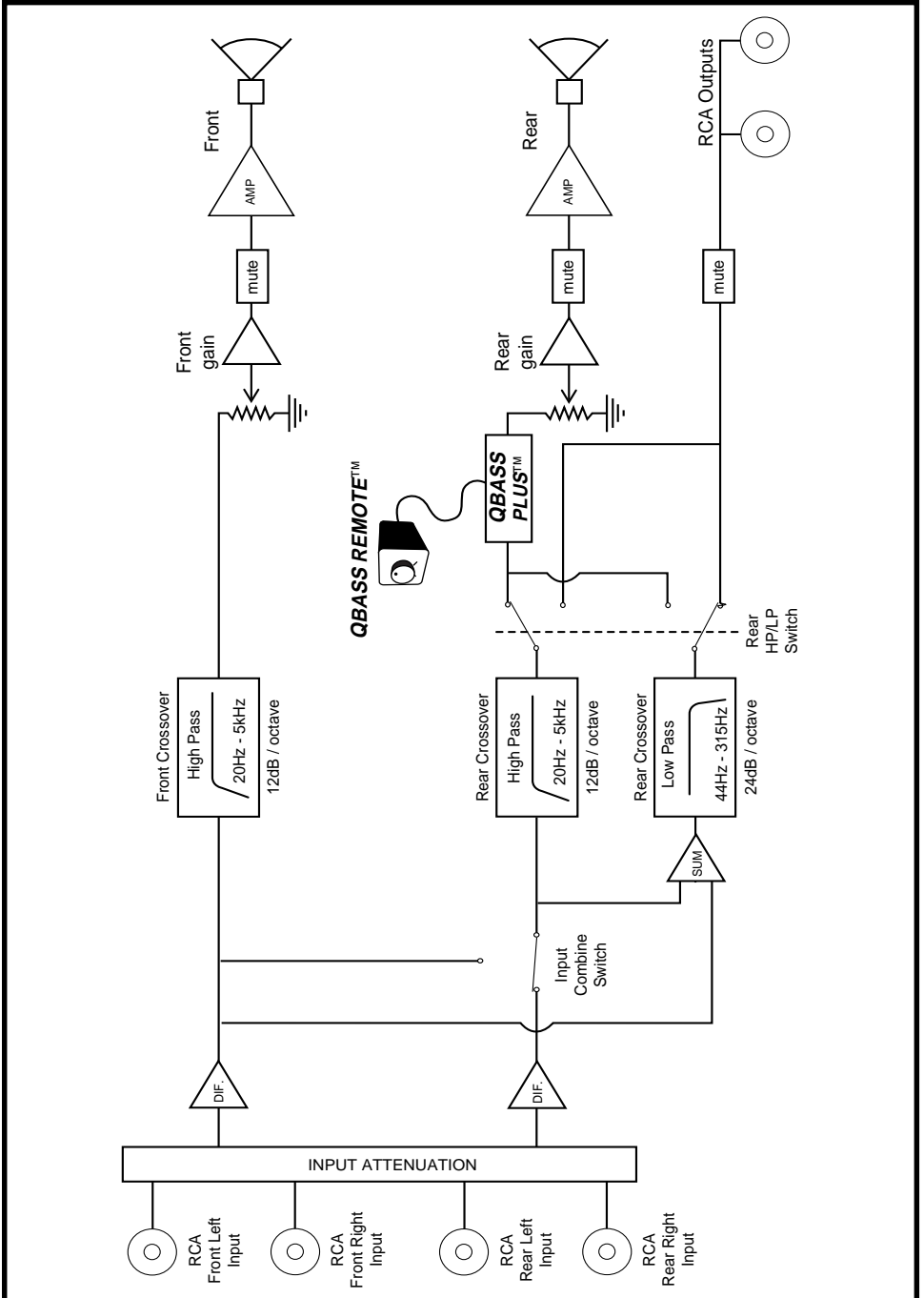

BLOCK DIAGRAM

6600

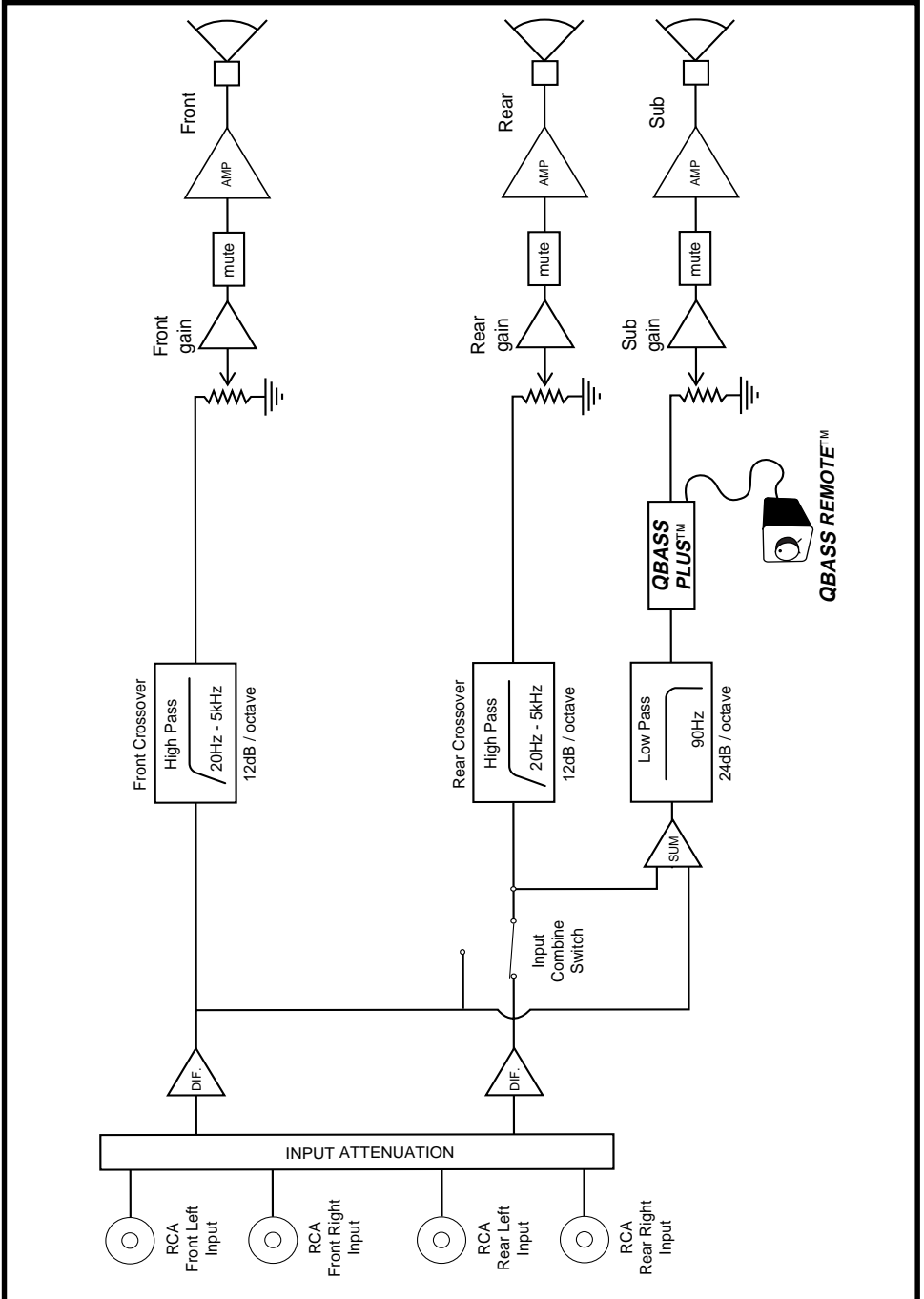

WARRANTY

Three-Year Limited U.S.A. Warranty

This warranty gives you specific legal rights, and you may also have other rights which vary from state to state. **PrecisionPower** warrants its products to be free from defects in materials and workmanship under normal use and service for a period of three (3) years from the date of original purchase when the unit is installed by an Authorized Dealer. Non-Authorized Dealer installed products carry a one (1) year parts and ninety (90) days labor limited warranty. The extent and conditions of Limited Warranty are as follows:

1. Authorized Dealer Installed Products: **PrecisionPower** will either repair or replace at no charge, to the original purchaser, any unit which **PrecisionPower's** examination discloses to be defective and under warranty, provided the defect occurs within three (3) years from the date of original purchase when the unit is installed by an Authorized Dealer and the product is returned immediately to **PrecisionPower**. This warranty is not transferable.

2. Non-Authorized Dealer Installed Products: **PrecisionPower** will either repair or replace at no charge, to the original purchaser, any unit which **PrecisionPower's** examination discloses to be defective and under warranty, provided the defect occurs within ninety (90) days from the date of purchase and the product is returned immediately to **PrecisionPower**. Warranty claims beyond ninety (90) days for Non-Authorized Dealer Installed Products will be for parts only and will extend for one (1) year from the date of purchase. This warranty is not transferable.

3. The date of purchase and proof of Authorized Dealer Installation of a PrecisionPower product must be established by an original sales receipt which must accompany the article being returned for warranty work.

4. This warranty shall NOT apply to any **PrecisionPower** product found to have the original factory serial number removed or defaced. All products received (by **PrecisionPower**) for in warranty or out of warranty repair, with their original serial numbers removed or defaced, will NOT be repaired and will be returned to sender, freight collect. Refer to original packaging for the serial number of your component speakers.

5. The provisions of this warranty shall not apply to any **PrecisionPower** product used for a purpose for which it is not designed, which has been repaired or altered in any way, or which has been connected, installed, or adjusted other than in accordance with the instructions furnished in **PrecisionPower's** owner's manual. Nor shall this warranty apply to any part which has been subject to misuse, neglect, or accident.

6. PrecisionPower does not authorize any other persons to assume any other liability in connection with its products. THIS WARRANTY IS THE ONLY EXPRESS WARRANTY MADE BY PRECISIONPOWER APPLICABLE TO ITS PRODUCTS. ANY IMPLIED WARRANTY OR MERCHANTABILITY OR FITNESS FOR A PARTICULAR PURPOSE APPLICABLE TO PRECISIONPOWER PRODUCTS IS LIMITED IN DURATION TO THE DURATION OF THIS LIMITED WARRANTY. PRECISIONPOWER SHALL NOT BE LIABLE FOR THE INCIDENTAL, CONSEQUENTIAL, OR COMMERCIAL DAMAGES RESULTING FROM THE BREACH OF THIS WRITTEN WARRANTY. Some states or provinces do not allow the exclusion or limitation of incidental or consequential damages or limitations on how long an implied warranty lasts; so the above limitations or exclusions may not apply to you.

7. Your product will be serviced on an in-warranty basis within the warranty period for the correction of warranted defects. If improper operation of your **PrecisionPower** product should occur, contact your Authorized Dealer for assistance with the return and factory repair of your **PrecisionPower** product. If an Authorized Dealer is not available, return the unit including your name, telephone number, return address, a copy of your sales receipt, and a description of the problem to:

PrecisionPower, Inc.
Service Department
4829 S. 38th Street
Phoenix, AZ 85040-2964

TO RETURN PRECISIONPOWER PRODUCTS OUT OF WARRANTY: Return the unit, postage prepaid, in the original protective carton. Please include a description of the problem and, if desired, a request for an estimate of repair costs. Unless a request for an estimate is included, the unit will be repaired as necessary. Please contact **PrecisionPower** Customer Service at 1-800-62-POWER for questions concerning out of warranty repair charges. Repaired unit will be returned with an itemized statement, C.O.D.

Free Manuals Download Website

<http://myh66.com>

<http://usermanuals.us>

<http://www.somanuals.com>

<http://www.4manuals.cc>

<http://www.manual-lib.com>

<http://www.404manual.com>

<http://www.luxmanual.com>

<http://aubethermostatmanual.com>

Golf course search by state

<http://golfingnear.com>

Email search by domain

<http://emailbydomain.com>

Auto manuals search

<http://auto.somanuals.com>

TV manuals search

<http://tv.somanuals.com>