



Owners Manual TD 450 / 4100

CONTENTS

(click on a topic to view)

- CONGRATULATIONS
- FEATURES / SPECIFICATIONS
- INSTALLATION
- WIRING
- POWER / GROUND
- CONNECTIONS
- CONNECTIONS (cont.)
- INPUTS / CONNECTIONS
- INPUTS
- ENDPANEL LAYOUT
- ENDPANEL LAYOUT (cont.)
- TROUBLESHOOTING
- TROUBLESHOOTING (cont.)
- TROUBLESHOOTING (cont.)
- TROUBLESHOOTING (cont.)
- SYSTEM DIAGRAM 1 / 2
- BLOCK DIAGRAM
- WARRANTY

CONGRATULATIONS



Thank you for choosing **TUBE DRIVER**. Tube Drivers musicality and absolute sonic transparency allow accurate reproduction of recorded music enabling you to hear as well as feel the music the way the artist intended. These handcrafted amplifiers feature full differential "front ends" based upon a true instrumentation amplifier topology. Tube Drivers utilize only the highest quality Svetlana tubes in our unique configurations. All of the internal amplifier stages have been designed to have ultra-wide bandwidth together with a high degree of linearity. The tubes used in these amplifiers provide both voltage gain and current gain where they are connected in Cascode and Cathode Follower configurations. D.C. servos are used to control any D.C. offset. These servos are critically positioned in the circuit so that not only is D.C. offset eliminated but also any subtle differences between tubes are internally compensated. These tube stages are then connected to a high current BiPolar output stage that uses the same audiophile quality Sanken output devices featured in the PrecisionPower 2500F1. The output stages receive their power from a highly regulated D.C. power supply which enhances their performance significantly. Very little negative feedback is used. Low feedback designs have greatly improved sound quality having an extremely warm and open sound with enhanced musicality consistent with only the highest quality home tube amplifiers.

Service

Do not attempt to service **TUBE DRIVER** products yourself. Performing exploratory surgery on your audio equipment yourself will void the warranty. Many parts of your **TUBE DRIVER** gear are custom built to our specifications. Our factory parts are not made available to anyone else nor are they for sale. Our goal is to make sure that your **TUBE DRIVER** product will always sound as good as the day it was purchased. Contact your authorized **TUBE DRIVER** dealer about obtaining any warranty service through **TUBE DRIVER**. (See Warranty inside back cover)

FOR YOUR RECORDS

M o d e l _____

Serial Number _____

Purchase Date _____

Caution!

The extended use of a high powered audio system may result in hearing loss or damage. While **TUBE DRIVER** systems are capable of "Concert Level" volumes with incredible accuracy, they are also designed for you to enjoy at more reasonable levels all of the sonic subtleties created by musicians. Please observe all local sound ordinances.

Features

Fully regulated adaptive MosFET power supply
Balanced Mini-Din Inputs
High Voltage Input Capability with Input Attenuation Switch
Gold Plated RCA Input connectors
Mixed Mono/Stereo Operation
Three Year Warranty when installed by an Authorized **TD** dealer
Completely Designed and Handcrafted in the USA

Specifications

Power Bandwidth:	5 Hz -50 KHz
Total Harmonic Distortion:	0.2% or less (A-weighted)
Input Topology:	Balanced Differential
Input Sensitivity:	500mV - 12 volts RMS
Input Impedance:	10K Ohms
Output Impedance:	2 - 16 Ohms, bridged 4 - 32 Ohms

Continuous Output Power

TD450

50 WRMS x 4 @ 4 Ohms per channel
100 WRMS x 4 @ 2 Ohms per channel
200 WRMS x 2 @ 4 Ohms bridged

TD 4100

100 WRMS x 4 @ 4 Ohms per channel
200 WRMS x 4 @ 2 Ohms per channel
400 WRMS x 2 @ 4 Ohms bridged

Dimensions

TD450

Length = 21.25
Height = 3.2"
Width = 9.25"

TD4100

Length = 24"
Height = 3.2"
Width = 9.25"

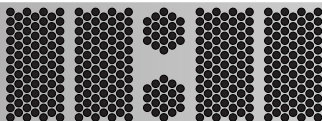

Tools/Parts Needed for Installation (not supplied)

- Small flat blade screwdriver
- Phillips screwdriver (#2 or medium sized)
- Wire cutters
- Wire strippers
- 4 – #6 round head screws, and 1 – #8 sheet metal screw
(or nut, bolt, and star washer)
- 2 – Ring connectors (large enough to accommodate your method of grounding)
- In-line fuse or circuit breaker — see fuse requirements below
- Power and groundwire — see Power Wire Calculator on the next page
- Speaker wire — 16 gauge or larger
- Grommets (sized to work with the power wire you plan to use in your installation)

Fuse Requirements

Recommended Fuse Rating for TD450 is 60 Amps
Recommended Fuse Rating for TD4100 is 100 Amps

You will need to install an in-line fuse or circuit breaker in the power wire within 18” of the battery. This fuse or circuit breaker protects your vehicle from fire in case the power wire shorts to the vehicle body. If you are only using one amplifier, use the recommended fuse rating. If you are using more than one amplifier, add up the fuse ratings for all amplifiers, and use this sum for your main fuse or circuit breaker. Use a power distribution block or fuse near your amplifiers with the appropriate fuse for each individual power wire.

The information below is a basic formula you can use to determine current draw. A 50% amplifier efficiency rating is used as an average. This formula is only a guideline. Using wire of a larger gauge can only improve the current transfer of your system. **Do not use smaller gauge wire.**

Total 4-Ohm rated RMS output x 2 = Total Input Wattage
Total Input Wattage/Supply Voltage = Current Draw (in Amps)

Example: Your TD450 has 4 channels at 50 watts per channel RMS into 4-Ohms (50 x 4 = 200). You would use the formula below:

$$200W \times 2 = 400W/12.5V = 32 \text{ Amps Total Current Draw}$$



Power Wire Calculator

Recommended MINIMUM Gauge

Total Current Draw (in Amps)	Length of Wire to Run (in Feet)							
	< 3	4 - 7	7 - 10	10 - 13	13-16	16-19	19-22	22- 28
0 - 20	14	12	12	10	10	8	8	8
20 - 35	12	10	8	8	6	6	8	4
35 - 50	10	8	8	6	6	4	4	4
50 - 65	8	8	6	4	4	4	4	2
65 - 85	6	6	4	4	2	2	2	0
85 - 105	6	6	4	2	2	2	2	0
105 - 125	4	4	4	2	2	0	0	0
125 - 150	2	2	2	2	0	0	0	0

Warning!
Amplifiers Generate Heat!

You can mount the **TUBE DRIVER** in any position, even upside-down. However, **you must maintain proper airflow**. Do not install your **TUBE DRIVER** under carpets or enclose it behind airtight panels. In trunk-mounted applications, be sure to provide venting for air circulation. **Let the amplifier breathe**. Without adequate air circulation, your Tube Driver will reduce its output power to protect itself.

Mounting

You need to mount your **TUBE DRIVER** securely in your vehicle to prevent damage. You may mount the system right-side up, on its side, or upside-down, provided there is adequate ventilation.



Warning!

To prevent a short to ground, disconnect the negative (-) terminal of the system's battery before you begin. If the power cable shorts to ground, current will continue to flow until the short is opened, the main fuse blows, the battery explodes, or the wire melts.

Reconnect the terminal only after you make all connections.

Grounding

Your **TUBEDRIVER** is designed to operate from a car's positive 12 volt, negative ground electrical system. The ground wire should be the same gauge as the power wire indicated in the chart.

The main power cable should run from the amplifier location, through or under the vehicle, to the battery. You must use a grommet wherever the cable passes through a steel panel to prevent an eventual short to ground.

The ground connection is the most important part of any installation. If the connections are poor and/or the resistance is high, the resulting drops in voltage will rob you of amplifier power and may allow noise to enter your system. Your new Tube Driver features a fully regulated power supply. It will make full power even if the voltage changes. It will draw more current at lower voltages to make that power. Lower voltage and high cable resistance means more total current draw. Using a digital multimeter (DMM), try to get cable resistance as low as possible. If resistance is too high, use a larger gauge wire. Try to ground your system to a single point in the vehicle. In larger systems, use distribution blocks and run both power and ground cables directly to the system battery.

Remote Turn-on

IMPORTANT! Your new Tube Driver is equipped with our unique tube warm-up circuit. When your system is turned on, The LED labeled "WARM UP" will illuminate and full power is applied to the tube heaters for approx. 35 seconds. The internal fan will then turn on and two seconds later the amp outputs will be switched on. The system will then play as normal.

You must connect a wire to the remote (REM) terminal (located in one of the speaker terminal plugs) of your amplifier to power on your **TUBEDRIVER**. The source unit normally provides a remote amp turn-on or power antenna lead that provides this +12 volts when you turn on the unit.

- Run a wire from the chosen turn-on lead to the REM connection of your **TUBEDRIVER** (See Endpanel Layout: Page 10)
- Tighten the connection

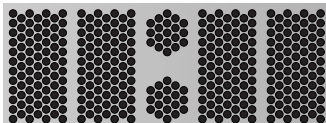

Speaker Connections

Follow these simple instructions and refer to the diagram below to make your speaker connections:

- Using at least 16 gauge wire, run wire from the speakers to the amplifier(s) using the same precautions that you followed for running the power, ground, and remote wires
- Cut off excess wire
- Use wire strippers to strip 1/4 inch of insulation at the end of the wires
- Attach the speaker wires to the amplifier's **POWERLOCK** connectors and plug them in

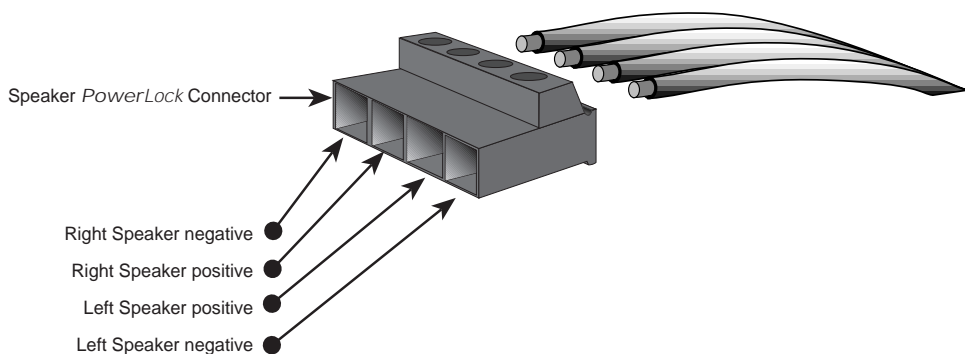
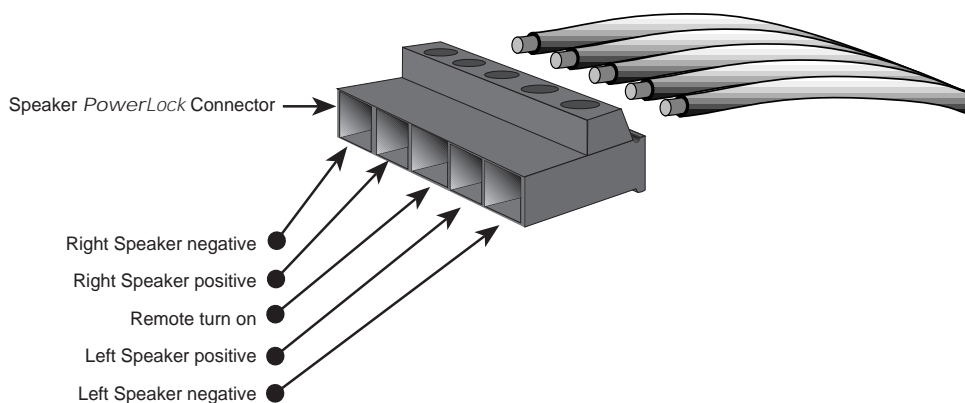



Bridging

All multi-channel **TUBE DRIVERS** are capable of being bridged into a 4-Ohm mono output without switches or bridging modules.

You can achieve this mono channel by using the left positive (+) speaker connection and the right negative (-) speaker connection. You can bridge the front or rear channels in the same way. (Refer to the end panel drawing on page 10.)

Note: Total bridged impedance of less than 4-ohms may trigger the protection circuitry causing reduced output and may eventually damage your amplifier.

Mixed Mono Output

You can operate each pair of channels in both stereo and mono (3 channel or tri-mode) at the same time by using highpass filters (bass blockers) on the higher frequency stereo channels, and a lowpass filter (coil) on the subwoofers. The frequencies of the chosen highpass and lowpass filters must not overlap (allow the mids and highs to play the same music as the subs) or the impedance the amplifier sees at those frequencies will be cut in half possibly causing the protection circuit to activate.

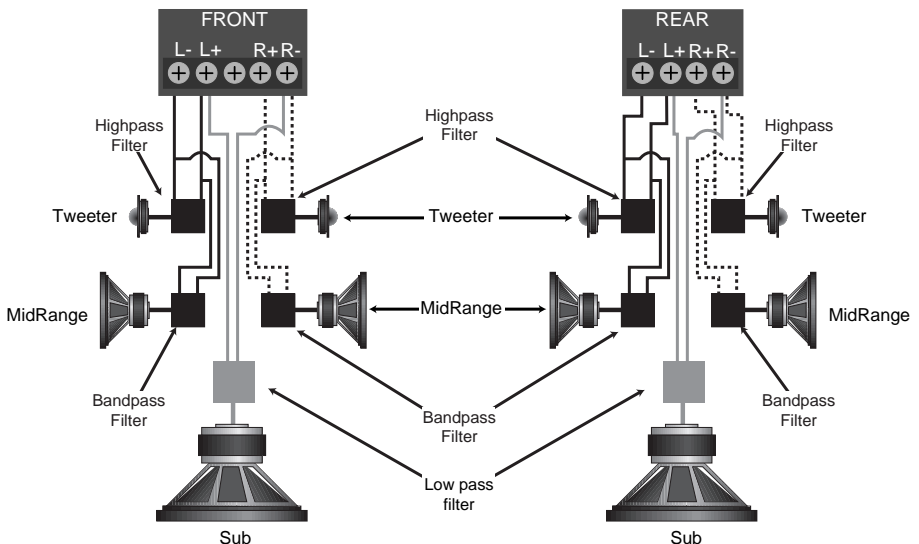

Input Jacks

The **TUBE DRIVER** includes both RCA and Mini-Din (balanced) inputs. The supplied RCA connections allow you to use **TUBE DRIVER** with other brands of audio gear. *Our Differential RCA inputs provide a dramatic improvement in noise reduction over standard RCA input types. Our fully balanced Mini-DIN connection system features high signal voltage capability and the highest possible sound quality. A single cable for 2 channels also simplifies installation.* Cables from the source unit, non-powered equalizer, or crossover go here.

Balanced Inputs

Standard Coaxial RCA Cables

Standard coaxial RCA cables utilize two connections: a center wire (signal positive) attached to the center pin of the RCA connector along with a braided outer conductor (signal negative) connected to the outer ring of the RCA connector. This design almost always allows radiated noise to enter the system, since the signal is not well protected.

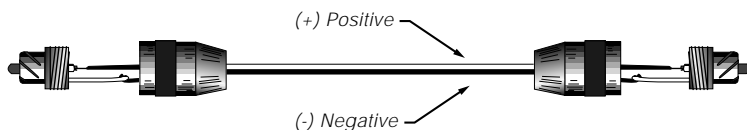

Balanced Mini-DIN Cable

Balanced Mini-Din connections use six pins and one grounding ring. Pins 1 and 2 are open connections, normally they would carry your remote turn on voltage. Pins 3/4 and 5/6 are pairs of twisted conductors for the music signal. The twisting of the inner wires rejects or eliminates radiated noise by more than 30 dB. The inner pair of wires are then protected by an outer shield connected to Pin 1. This means the music signals can be kept as far away as possible from the power and chassis ground paths of other circuitry, allowing the transmission of pure music between points while protecting it from noise generating equipment and wiring present in the vehicle. The diagram below shows the pin configuration for the Mini-Din connections.

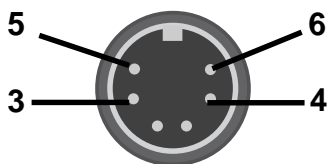



Input Gain Controls

There are two Input Gain Controls located on the end panel under the RCA input jacks. **These are not volume controls!** These controls match the output signal voltage of the source unit to the amplifier inputs.

By turning the controls clockwise (to the right), the inputs of the amplifier become more sensitive and will allow a weak signal of approximately 1/2 volt to drive the amplifier to full power. At the same time, while an amplifier with its level controls at maximum is able to drive a weak signal, it also picks up and amplifies any noises lurking in the background, such as a brake light *pop*, alternator *whine*, or ignition *tick*.

Increasing the signal voltage to the amplifier by using a high output source unit, or a TUBE DRIVER LD-3, will increase the signal to noise ratio . By turning the level controls counterclockwise (to the left), the amp inputs will be less sensitive. The amp will reproduce music at full power while making any noise floor insignificant. Your **TUBEDRIVER** accepts signal levels of up to 12 volts RMS.

Setting Input Gain

1. Set the Input Gain Controls to just above the lowest setting.
2. Turn the master volume on the source unit or pre-amp to almost full volume.
3. With music playing, slowly increase each Input Gain Control until you hear distortion. Turn down each Gain Control until the distortion stops.

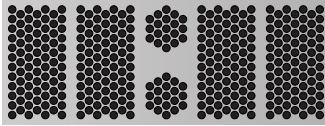

ENDPANEL LAYOUT

Power Side

1. POWER

A red light indicates that the amplifier is turned on (After warm-up sequence).

2. WARM UP

A red light indicated that the tubes are warming up. (Refer to Pg. 4; Remote Turn-on)

3. POWER / GROUND

After you have securely connected your power and ground wires, plug in the connector here.

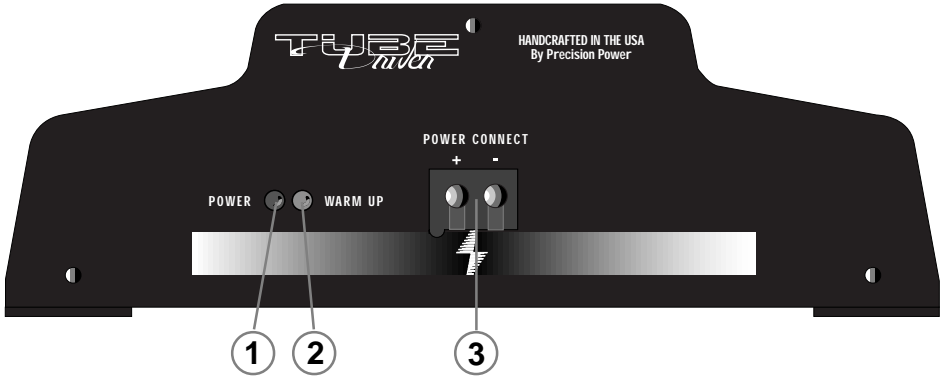

TUBE *Driver*



Input/Control Side

1. -12dB

For use with high level inputs (4V up to 12V). Push this switch in to attenuate the input by 12dB

2. BALANCED / RCA

This switch is used to select between the unbalanced RCA inputs or the balanced MINI-DIN front inputs. In=MiniDIN. Out=RCA

3. FRONT INPUTS

Plug in the front RCA outputs from your head unit here.

4. BALANCED FRONT AND REAR INPUTS

Plug in the front and rear mini-din outputs from the LDX-33 crossover, LD-3 Line Driver, or other balanced source here.

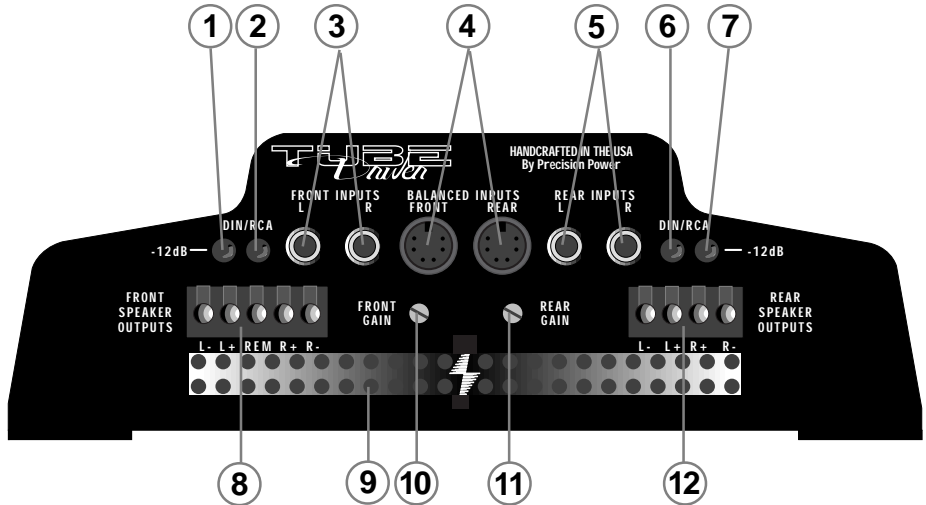

5. REAR INPUTS

Plug in the rear RCA outputs from your head unit here.

6. BALANCED / RCA

This switch is used to select between the unbalanced RCA inputs or the balanced MINI-DIN rear inputs. (See #2)

7. -12dB

For use with high level inputs (4V up to 12V). Push this switch in to attenuate the input by 12dB. (See #1)

8. FRONT SPEAKER OUTPUTS/REMOTE (Turn-on)

After connecting remote and front speaker wires plug in the connector here.

9. COOLING VENTS

10. FRONT GAIN

Use this control to match the output level of the head unit to the front channels of the amplifier.

11. REAR GAIN

Use this control to match the output level of the head unit to the rear channels of the amplifier.

12. REAR SPEAKER OUTPUTS

After connecting the rear speaker wires, plug in the connector here.



No Sound

Is the WARM UP LED illuminated?

YES

The warm up cycle can take up to 40 sec., Is there sound after that?

NO

Is there signal on the RCA's?

YES

Contact your dealer

YES

You're done

NO

Do you have 12V at the amplifier's connections?

YES

Does the amp remote (REM) have 12V?

YES

Check main system fuse. Did that work?

YES

You're done

NO

Trace back the amp remote to your source unit. Repair as needed

NO

Check all connections. Repair as needed

Amplifier Turning Down at Normal Volume

Turn the system off, wait approx. 5 min., then turn the system back on. Listen for awhile. Did it work?

NO

Check speaker wires for shorts or other damage and correct as needed. Did that fix the problem?

YES

You're done

NO

Check voltage supply to ensure sufficient voltage. Did that work?

YES

You're done

NO

Contact your dealer

If sound is heard, the Amp may have thermally turned down. Check for proper air flow and correct as needed. You're done.



No Sound in One Channel

Check the pre-amp (RCA/Mini-Din) cables for open connections and make corrections. Did you find open connections?

NO

YES

Reverse the left and right inputs.

You're done

SOUND IS NOW IN...

Opposite Channel

Problem is further up the signal path. Reconnect RCA's to amp as normal. Reverse RCA inputs at crossover.

Same Channel

Problem is in the speaker or speaker wire of the silent channel. Check speaker leads for pinched, shorted, or open connections.

SOUND IS NOW IN...

Opposite Channel

Reverse RCA outputs of head unit

Same Channel

Problem is in the crossover. Contact your dealer.

SOUND IS NOW IN...

Opposite Channel

Problem is in the head unit

Same Channel

Problem is in the RCA cables.

Amplifier Turning Down at High Volume

Check speaker cables for shorts. Check for excessively low speaker impedance. Fixed?

NO

YES

Check voltage supply to ensure sufficient voltage is being delivered. Is amp getting enough air to cool off? Did that solve the problem?

You're done

NO

YES

If using passive crossovers, are the connections correct?

You're done

NO

YES

Voltage at amp may be dropping below minimum limits.

Power output of amp may exceed power handling of parts. Upgrade as needed.

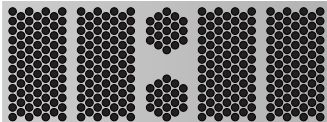

Noises While the Engine is On

Alternator whine:

This noise changes in frequency with engine RPM. Check for:

- **Excessive input level setting on the amplifier**
- **High resistance in cabling or corroded and/or loose connections**
- **Polarity of the input cables**

If the problem persists, check the *whines and pops checklist* below.

Ticks/buzz:

This noise should go faster and slower with engine RPM, but not really change in frequency. This is due to the ignition or the fuel pump.

- **Try moving the input cables to avoid contact with the fuel pump or wiring**

If the problem persists, check the *whines and pops checklist* below.

Accessory pop:

This popping noise occurs as the result of turn signals, brake lights, etc. You can try:

- **Moving the cables to avoid contact with the wires for the accessories**
- **Relocating various ground connections**

Whines and pops:

If you have a combination of noises, or if one or more of the problems listed above persists despite efforts to stop the problem, the noise may be caused by one or more of the following problems:

- **Excessively high input level setting on the amplifier**
- **Poor or open shielding, extra long cables or corroded input cables**
- **Bad connections**
- **Bad (or high resistance) system ground**
- **Reversed polarity on audio signal cables**
- **Poor quality source unit**



Noises While the Engine is On or Off

System hiss:

System hiss is a white noise that occurs even when the engine is off. It is usually due to excessively high gain settings. If the hiss is still audible when you disconnect the input cables from the amplifier, check the input level on the amplifier. If the hiss disappears when you remove the input cable, it may be a poor quality source unit, components between the amplifier and the source unit, or poor level settings.

Distortion:

Distortion is garbled sounding music. This can often be caused by a shorted speaker wire. Symptoms of this include no sound in one channel and severe distortion in the other. Use the following guide to help you find the source of distortion.

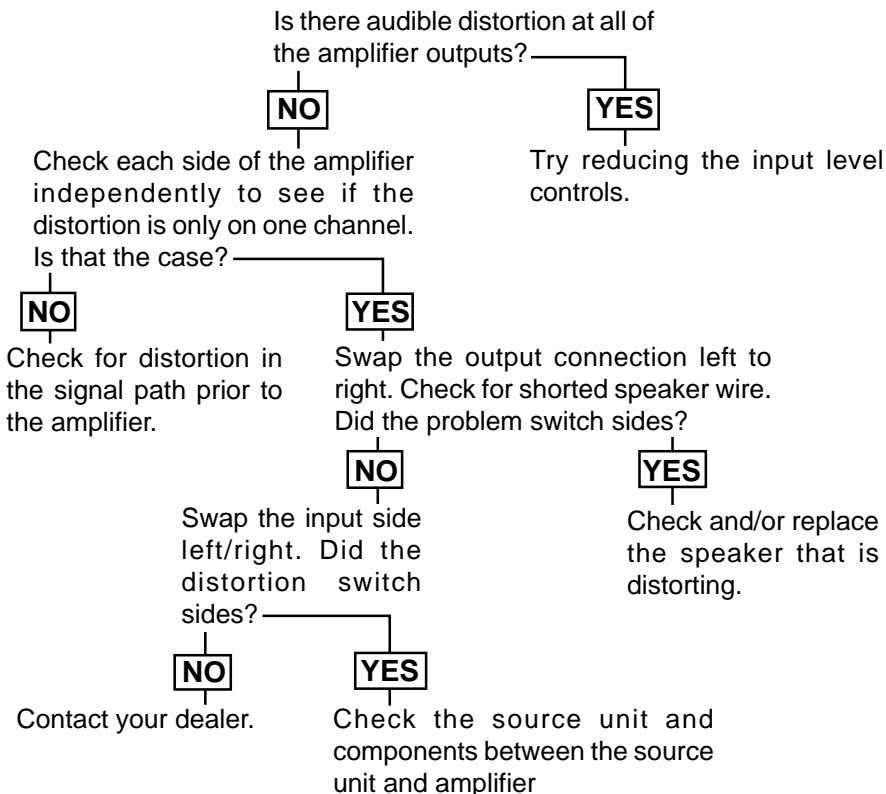



SYSTEM DIAGRAM ONE/TWO

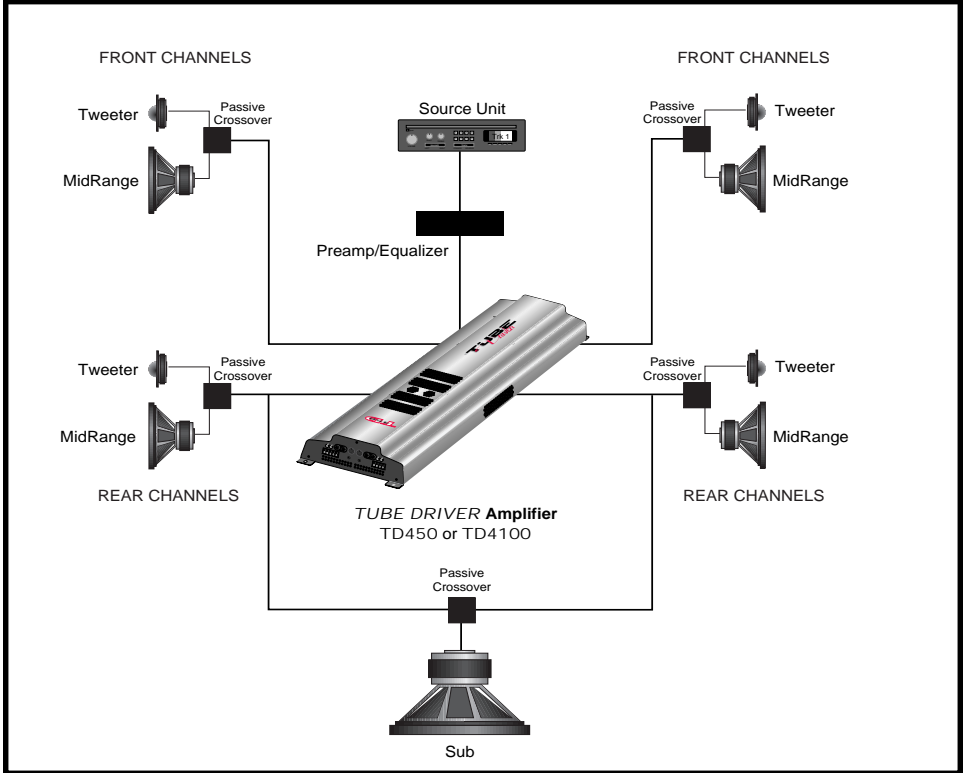
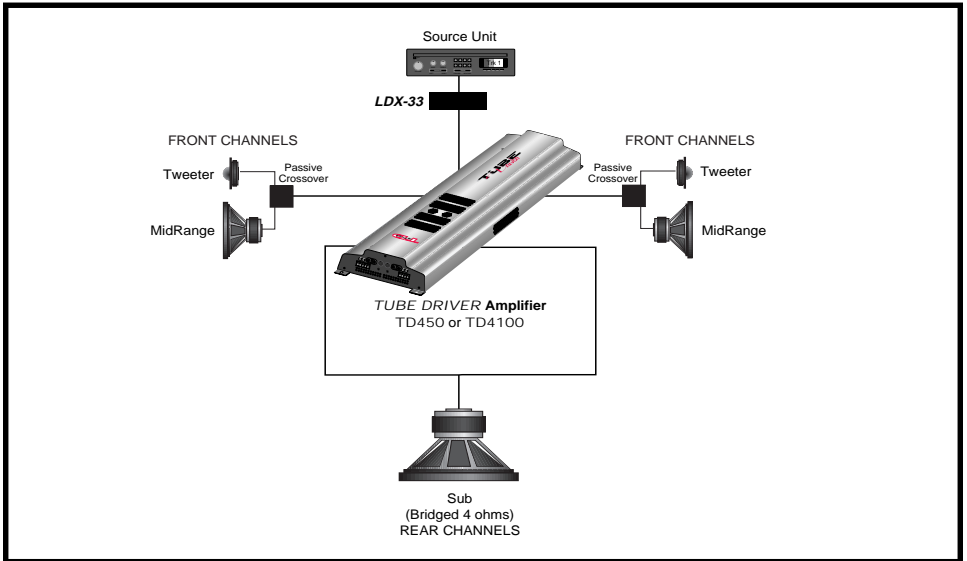

BLOCK DIAGRAM 450/4100

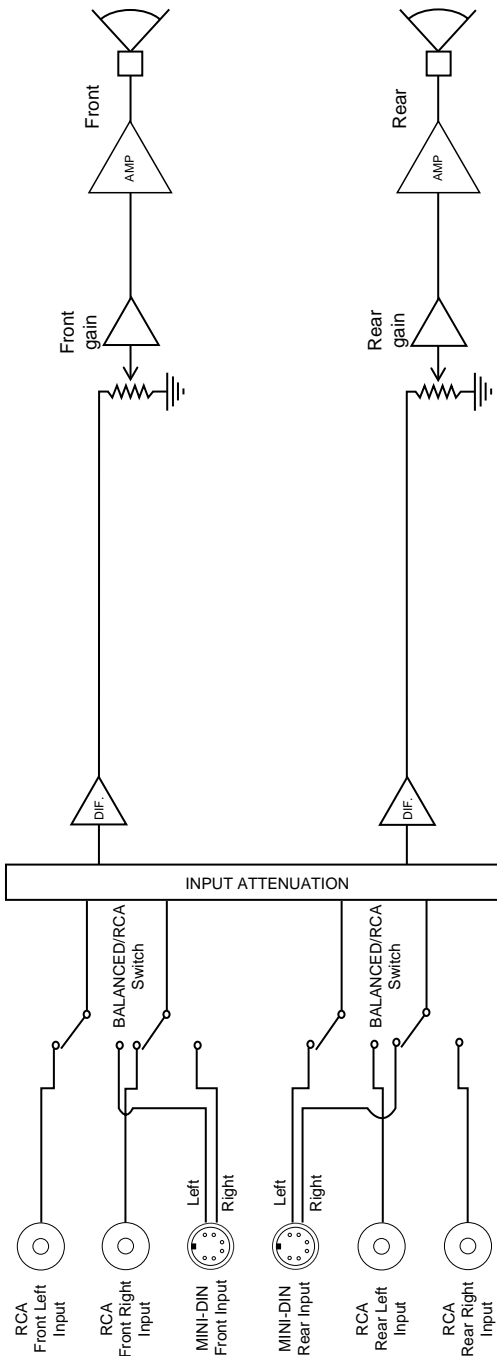



Three-Year Limited U.S.A. Warranty

This warranty gives you specific legal rights, and you may also have other rights which vary from state to state. **TUBE DRIVER** warrants its products to be free from defects in materials and workmanship under normal use and service for a period of three (3) years from the date of original purchase when the unit is installed by an Authorized Dealer. Non-Authorized Dealer installed products carry a one (1) year parts and ninety (90) days labor limited warranty. The extent and conditions of Limited Warranty are as follows:

1. Authorized Dealer Installed Products: **TUBE DRIVER** will either repair or replace at no charge, to the original purchaser, any unit which upon examination discloses to be defective and under warranty, provided the defect occurs within three (3) years from the date of original purchase when the unit is installed by an Authorized Dealer and the product is returned immediately to **TUBE DRIVER**. This warranty is not transferable.

2. Non-Authorized Dealer Installed Products: **TUBE DRIVER** will either repair or replace at no charge, to the original purchaser, any unit which upon examination discloses to be defective and under warranty, provided the defect occurs within ninety (90) days from the date of purchase and the product is returned immediately to **TUBE DRIVER**. Warranty claims beyond ninety (90) days for Non-Authorized Dealer Installed Products will be for parts only and will extend for one (1) year from the date of purchase. This warranty is not transferable.

3. The date of purchase and proof of Authorized Dealer Installation of a **TUBE DRIVER** product must be established by an original sales receipt which must accompany the article being returned for warranty work.

4. This warranty shall NOT apply to any **TUBE DRIVER** product found to have the original factory serial number removed or defaced. All products received (by **TUBE DRIVER**) for in warranty or out of warranty repair, with their original serial numbers removed or defaced, will NOT be repaired and will be returned to sender, freight collect. Refer to original packaging for the serial number of your component speakers.

5. The provisions of this warranty shall not apply to any **TUBE DRIVER** product used for a purpose for which it is not designed, which has been repaired or altered in any way, or which has been connected, installed, or adjusted other than in accordance with the instructions furnished in **TUBE DRIVER'S** owner's manual. Nor shall this warranty apply to any part which has been subject to misuse, neglect, or accident.

6. **TUBE DRIVER** does not authorize any other persons to assume any other liability in connection with its products. THIS WARRANTY IS THE ONLY EXPRESS WARRANTY MADE BY TUBEDRIVER APPLICABLE TO ITS PRODUCTS. ANY IMPLIED WARRANTY OR MERCHANTABILITY OR FITNESS FOR A PARTICULAR PURPOSE APPLICABLE TO TUBEDRIVER PRODUCTS IS LIMITED IN DURATION TO THE DURATION OF THIS LIMITED WARRANTY. TUBEDRIVER SHALL NOT BE LIABLE FOR THE INCIDENTAL, CONSEQUENTIAL, OR COMMERCIAL DAMAGES RESULTING FROM THE BREACH OF THIS WRITTEN WARRANTY. Some states or provinces do not allow the exclusion or limitation of incidental or consequential damages or limitations on how long an implied warranty lasts; so the above limitations or exclusions may not apply to you.

7. Your product will be serviced on an in-warranty basis within the warranty period for the correction of warranted defects. If improper operation of your **TUBE DRIVER** product should occur, contact your Authorized Dealer for assistance with the return and factory repair of your **TUBEDRIVER** product. If an Authorized Dealer is not available, return the unit including your name, telephone number, return address, a copy of your sales receipt, and a description of the problem to:

TUBE DRIVER, Inc.
Service Department
4829 S. 38th Street
Phoenix, AZ 85040-2964

TO RETURN TUBEDRIVER PRODUCTS OUT OF WARRANTY: Return the unit, postage prepaid, in the original protective carton. Please include a description of the problem and, if desired, a request for an estimate of repair costs. Unless a request for an estimate is included, the unit will be repaired as necessary. Please contact **TUBE DRIVER** Customer Service at 1-888-627-6937 for questions concerning out of warranty repair charges. Repaired unit will be returned with an itemized statement, C.O.D.

Free Manuals Download Website

<http://myh66.com>

<http://usermanuals.us>

<http://www.somanuals.com>

<http://www.4manuals.cc>

<http://www.manual-lib.com>

<http://www.404manual.com>

<http://www.luxmanual.com>

<http://aubethermostatmanual.com>

Golf course search by state

<http://golfingnear.com>

Email search by domain

<http://emailbydomain.com>

Auto manuals search

<http://auto.somanuals.com>

TV manuals search

<http://tv.somanuals.com>