

Product Owner's Manual

C842i C846i

Commercial Cycles



PRECOR[®] USA
move beyond[®]

Important Safety Instructions

When using the self-powered C846i/C842i cycle, always take basic precautions, including the following:

- Read all instructions before using the cycle. These instructions are written to protect the unit and ensure the safety of those using the cycle.
- Before beginning any fitness program, make sure all users see a physician for a complete physical examination.

Il est conseillé de subir un examen médical complet avant d'entreprendre tout programme d'exercice. Si vous avez des étourdissements ou des faiblesses, arrêtez les exercices immédiatement.

DANGER To reduce the risk of electrical shock always unplug the optional power adapter before cleaning the unit.

WARNING To reduce the risk of burns, fire, electric shock, or injury, take the following precautions:

- Do not allow children or those unfamiliar with its operation on or near the cycle. Do not leave children unsupervised around the unit.
- Never leave the cycle unattended with the optional power adapter plugged in. Remove the optional power adapter before cleaning the cycle, and before putting on or taking off parts.
- Assemble and operate the cycle on a solid, level surface. Locate the cycle a few feet from walls or furniture.

- Maintain the cycle in good working condition. Refer to the *Maintenance* section. Make sure that all fasteners are secure.
- If you plan to move the unit, obtain help and use a hand truck. Do not grasp any plastic parts while lifting or moving the unit. The unit is too heavy and the plastic parts will break.
- Use the cycle only for its intended purpose as described in this manual. Do not use accessory attachments that are not recommended by the manufacturer, as such attachments may cause injuries.
- Never operate the unit if it is damaged, not working properly, when it has been dropped, or has been dropped in water. Refer to *Obtaining Service*.
- Keep the optional power adapter and power cord away from heated surfaces.
- Do not operate the cycle where aerosol (spray) products are being used or where oxygen is being administered.
- Do not use outdoors.
- Do not attempt to service the cycle yourself except to follow the maintenance instructions found in this manual.
- Never drop or insert objects into any opening. Keep hands away from moving parts.
- Do not set anything on the handrails or covers. Place liquids, magazines, and books in the appropriate receptacles.

Safety Approval

When identified with the ETL-c logo, the unit has been tested and conforms to the requirements of CAN/CSA-E-335-1/3-94, *Safety of Household and Similar Electrical Appliances*.

Hazardous Materials and Proper Disposal

The self-powered cycle has an internal battery which contains materials that are considered hazardous to the environment. Proper disposal of the battery is required by federal law.

If you plan to dispose of your unit, contact Precor Commercial Products Customer Support for information regarding battery removal. Refer to *Obtaining Service*.

Radio Frequency Interference (RFI)

Federal Communications Commission, Part 15

The cycle has been tested and found to comply with

- the IEC EMC Directive (international electromagnetic compatibility certification)
- the limits for a Class A digital device, pursuant to Part 15 of the FCC Rules. These limits are designed to provide reasonable protection against harmful interference in a residential installation. The cycle generates, uses, and can radiate radio frequency energy and, if not installed and used in accordance with the owner's manual instructions, may cause harmful interference to radio communications.

WARNING Per FCC rules, changes or modifications not expressly approved by Precor could void the user's authority to operate the equipment.

Canadian Department of Communications

This digital apparatus does not exceed the Class A limits for radio noise emissions from digital apparatus set out in the Radio Interference Regulations of the Canadian Department of Communications.

Le présent appareil numérique n'émet pas de bruits radioélectriques dépassant les limites applicables aux appareils numériques de la class A prescrites dans le Règlement sur le brouillage radioélectrique édicté par le ministère des Communications du Canada.

ATTENTION: Haute Tension

Débranchez avant de réparer

European Applications

This product conforms to the requirements of the European Council Directive 89/336/EEC, Electromagnetic Compatibility and has been tested to the following standards:

EN55022, Limits & Methods of Measurement of Radio Interference, Information Technology Equipment.

EN50082-1, Generic Immunity Standard for Residential, Commercial and Light Industrial Products.

This product also conforms to the requirements of the European Council Directive 73/23/EEC, Low Voltage Directive and has been tested to the following standard:

IEC 335-1, Safety of Household and similar Electrical Appliances.

Obtaining Service

You should not attempt to service the cycle except for maintenance tasks as described in this manual. For information about product operation or service, see the Precor website at www.precor.com. Should you need more information regarding customer support numbers or a list of Precor authorized service centers, visit the Precor website at www.precor.com/contact.

For future reference, write the model, serial number, and date of purchase for all your units in the space provided. The serial number is printed on a label located on the rear cover (Diagram 1).

Model #: _____ Serial #: _____

Date purchased: _____

Model #: _____ Serial #: _____

Date purchased: _____

Model #: _____ Serial #: _____

Date purchased: _____

Model #: _____ Serial #: _____

Date purchased: _____

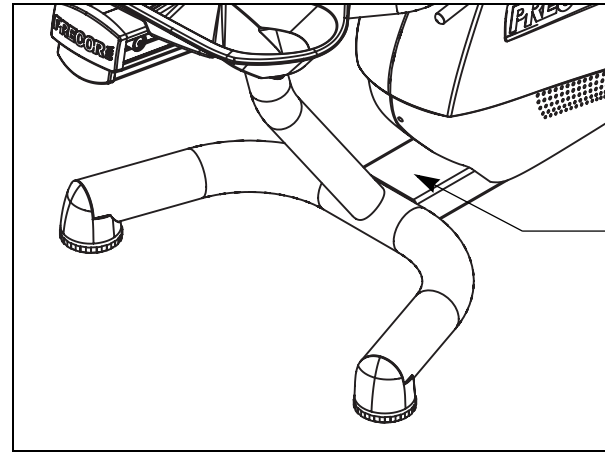

Diagram 1: Location of serial number

Table of Contents

Important Safety Instructions	1	Maintenance	19
Safety Approval	2	Daily Inspection	19
Hazardous Materials and Proper Disposal	2	Daily Cleaning	19
Radio Frequency Interference (RFI)	2	Cleaning the Equipment	19
Canadian Department of Communications	3	Storing the Chest Strap	19
European Applications	3	Long-Term Storage	20
Obtaining Service	4	Adjusting the Seat	20
Self-Powered Features	6	Upright Cycles: Adjusting the Seat Tilt	21
Informational Displays Prior to Shutdown	6	Recumbent Cycles: Realigning the Seat	22
Symptoms of a Low Battery	7	Using the Optional Power Adapter	23
The Optional Power Adapter	7	Troubleshooting Error Codes	24
Replacing the Battery	7	Troubleshooting Heart Rate	24
Club Features	8	Precor Commercial Equipment	
Club Programming Tips	8	Limited Warranty.....	25
Choosing a Language	9		
Selecting a U.S. Standard or Metric Display	9		
Setting a Workout Time Limit	10		
Setting a Pause Time Limit	10		
Setting a Resistance Range (C846i)	11		
Changing the Custom Program	12		
Informational Displays (C842i)	13		
Informational Displays (C846i)	15		
User ID Entry with CSAFE Equipment	17		

Self-Powered Features

The power source for the cycle is the user. When a person maintains a pedal speed above 20 revolutions per minute (RPM), the power that is generated allows the cycle to function properly.

Informational displays appear when the battery is low or when the user reduces the pedal speed below the minimum requirement. The display explains what to do to retain power. If the messages are ignored, the cycle begins shutdown procedures to maintain the charge of the battery. Refer to *Informational Displays Prior to Shutdown*.

An optional power adapter can be purchased and provides sustained power to the cycle. If you plan to customize your unit, the power adapter is highly recommended. To purchase the optional power adapter, check with your dealer. Refer to *Obtaining Service*.

Informational Displays Prior to Shutdown

The cycle saves its battery charge by moving into a shutdown mode. Whenever PEDAL FASTER appears on the display, the heart rate, SmartRate® and program indicators turn off. If the user does not maintain a pedal speed of 20 RPM, then a 20-second shutdown process begins.

When 28 seconds remain, 28 dots appear in the center display. All key presses are ignored except RESET. If no one begins pedaling, a dot disappears every second as the countdown continues.

Note: The user can resume exercising if he or she begins pedaling before the 28-second period elapses.

Product Owner's Manual: Self-Powered Features

Note: If the cycle is connected to a CSAFE master device, a slightly different scenario occurs. When ten seconds remain before the cycle shuts off, the workout session ends. RESETTING appears in the lower display while the cycle disconnects from the CSAFE master device. All key presses are ignored. pedaling has no effect on the display.

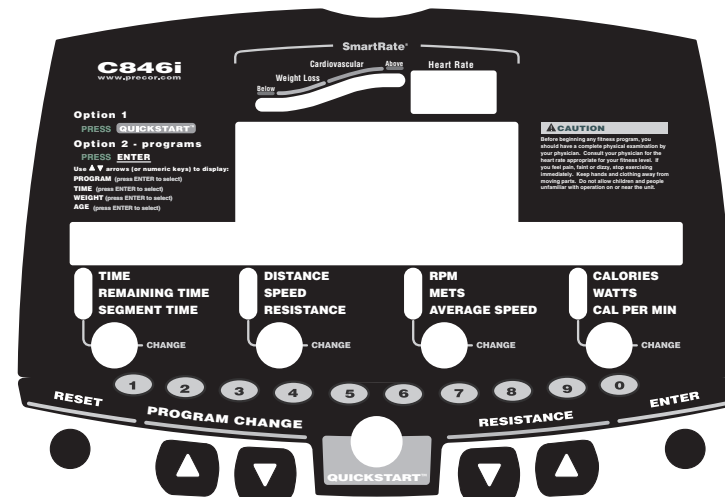

Diagram 2: C846i display

Symptoms of a Low Battery

If no one has used the cycle for an extended period of time, the battery may need recharging.

Symptoms of a low battery include:

- A flickering or erratic display
- No workout statistics appear or accumulate
- Changes to the pedal speed are ignored

The cycle continues to function with a low battery, but user and program information is lost once the user stops pedaling.

Note: To maintain a constant power source, use the optional power adapter.

The Optional Power Adapter

The display functions differently when the power adapter is connected. Because the power adapter provides a constant source of power, the user can stop pedaling during a workout and pause for brief periods without the cycle initiating shutdown procedures. When the pause time limit expires and the user has not resumed pedaling, the display returns to the Precor banner. Refer to *Setting a Pause Time Limit*. To learn how to use the power adapter, refer to *Using the Optional Power Adapter*.

Replacing the Battery

The internal battery is built to last for a long time. However, if you feel that the battery may need replacing, check with an authorized service technician. Refer to *Obtaining Service*.

CAUTION: The battery stored inside the cycle C846i/C842i contains hazardous materials and must be disposed of according to Hazardous Waste Regulations. Refer to *Hazardous Materials and Proper Disposal*.

Club Features

These next few pages provide information that lets you customize the cycle for your club. All these features remain hidden to the club patrons and can only be accessed using special key presses. Read this section if you want to:

- Change the display to a different language
- Change the display to U.S. Standard or Metric
- Set the maximum workout and pause times
- Set a cool-down time limit
- Customize a program
- View the odometer
- Display the number of hours the cycle has been in use
- View the software versions and part numbers
- Check the error log
- Display the serial number
- Connect to CSAFE equipment

Club Programming Tips

- Electrical power must be supplied. A minimum pedal speed (20 revolutions per minute) must be maintained while programming the cycle. A constant power source is available if you use the optional power adapter. If you plan to program the cycle, purchasing the optional power adapter is highly recommended.
Note: If you do not use the optional power adapter during club programming mode, and the pedal speed falls below 20 RPM, no warning is given when the cycle moves into its 30-second shutdown procedure.
- The club programming mode is accessed by pressing the RESET key at the Precor banner. The remaining key presses must occur quickly and without pause. Always start at the Precor banner.
- The function of the QUICKSTART key is disabled while in club programming mode.
- The club programs appear sequentially. Pressing the ENTER key on the C846i or the SELECT on the C842i saves the changes you make and moves you through the programs. To exit a program without saving any changes, press the RESET key.

Choosing a Language

The cycle can display user prompts, text, and user entries in six different languages. When the cycle is shipped from the factory, it is set to display English. To change this setting, perform the following steps:

1. At the Precor banner, press the following C846i number keys in sequence and without pause:

RESET, 5, 6, 5, 1, 5, 6, 5

Numbers appear on the display as you press the associated key.

Note: The C842i does not have a number keypad, so each key is associated with a number. Refer to Diagram 4. To enter club programming mode and change the language, press the following sequence: RESET, SELECT, RESISTANCE ▼, SELECT, COURSE CHANGE ▲, SELECT, RESISTANCE ▼, SELECT.

At the SELECT LANGUAGE prompt, use the arrow keys to choose between ENGLISH, DEUTSCH, ESPANOL, FRANCAIS, NEDERLANDS, RUCCKIJJ (C846i only), and PORTUGUES.

Note: Programming prompts are not affected by language selection. The prompts in this section continue to appear in English.

2. When you are ready, press SELECT (C842i) or ENTER (C846i) to move to the next program or press RESET to return to the Precor banner.



Diagram 3: C842i display and keypad numbers

Selecting a U.S. Standard or Metric Display

The cycle can display measurements in either METRIC or U.S. STANDARD. The default factory setting is set to display U.S. STANDARD. To change this setting, perform the following steps:

3. At the SELECT UNITS prompt, use an arrow key to select a unit of measure (U.S. STANDARD or METRIC).
4. When you are ready, press SELECT (C842i) or ENTER (C846i) to move to the next program or press RESET to return to the Precor banner.

Setting a Workout Time Limit

You can limit how long a user can exercise on the cycle. For example, if you set the time limit to 20 minutes, users can only enter a workout time between 1 and 20 minutes.

Note: The automatic cool-down period is appended to the end of any time-based program, so adjust the time limit accordingly.

You can also let a user exercise indefinitely by selecting the NO LIMIT option. You will need to instruct users to select NO LIMIT (C842i) or press the number 0 (C846i) when they are prompted for a workout time.

Note: The REMAINING TIME (C846i) display will not appear if the NO LIMIT option is chosen.

The range of workout time available are:

Cycle	Workout Time
C842i	1 to 99 minutes
C846i	1 to 240 minutes

5. At the SET MAX WORKOUT TIME prompt, use the arrow keys to display the available time limits. Choose between 1 and 240 minutes. Or, choose NO LIMIT.

Note: When you press and hold an arrow key, the selections increment by five, for example, 1, 5, 10, 15, and 20. When you tap an arrow key, the selections increment by one.

6. When you are ready, press SELECT (C842i) or ENTER (C846i) to move to the next program or press RESET to return to the Precor banner.

Setting a Pause Time Limit

You can limit how long a user can pause while exercising on the cycle by entering a time between 1 and 120 seconds (two minutes). For example, if you set the pause time limit to 60 seconds, the display automatically resets to the Precor banner if no pedaling or key press occurs for one minute.

Important: The optional power adapter must be connected to establish a pause time limit. If the optional power adapter is not attached and the pedal speed drops below 20 revolutions per minute, the cycle begins its 30-second shutdown effectively eliminating pause mode.

7. At the SET MAX PAUSE TIME prompt, use the arrow keys to cycle through the available time limits. Choose between 1 and 120 seconds (two minutes).
8. When you are ready, press SELECT (C842i) or ENTER (C846i) to move to the next program or press RESET to return to the Precor banner.

Setting a Resistance Range (C846i)

You can set a low, medium or high range of resistance on the C846i cycle. Within each group, 25 resistance settings are available, but the chosen group affects the overall resistance range.

An example of where you might use this programming feature is physical therapy conditioning. If a user has an injury that needs low levels of resistance, you might set the resistance range to low to help ensure that the user does not induce further injury by exceeding your recommended levels of resistance. The following table provides short description of each group.

Setting	Description
HIGH	provides the full range of resistance available. If an upright cycle user chooses the high-end resistance levels, the cycle provides enough resistance to simulate sprinting or hill climbing for users wishing to stand on the upright cycle. It also provides enough resistance for elite riders that are capable of spinning at high speed with high resistance.
MEDIUM	provides approximately two thirds of the resistance that is available within the HIGH group setting. Club owners may want to select the MEDIUM range for recumbent cycles. Since users cannot stand on recumbent cycles, less resistance is needed by the average (non-elite) user. A MEDIUM range may provide more comfort. It also allows users to make easier resistance changes in the preset programs (HILL CLIMB and CROSS COUNTRY).
LOW	provides approximately one third of the resistance that is available within the HIGH group setting. The LOW range may be appropriate in special situations where poorly conditioned users are anticipated. The LOW range is not recommended for the club environment.

9. At the SET RESISTANCE RANGE prompt, use an arrow key to choose LOW, MEDIUM or HIGH.
10. When you are ready, press ENTER to save your changes and move to the next program. If you prefer to exit the program without saving your changes, press RESET.

Changing the Custom Program

Important: To change the Custom Program, it is highly recommended that you use the optional power adapter. Otherwise, you will need to maintain a pedal speed above 20 revolutions per minute to keep the cycle from shutting down.

When you design a custom program, you are preprogramming the resistance for each column in the program profile.

11. A blinking column appears in the display. Use the COURSE CHANGE ▼▲ keys to change the height of the column.
12. When the column height is set, use RESISTANCE ▲ to move to the next column. You can use RESISTANCE ▼ to move back and change earlier columns as needed.
13. Continue setting resistance level for each column in the profile.

14. When you are ready, press ENTER to save the program and return to the Precor banner.

Note: If you prefer to exit the program without saving changes to the custom profile, press RESET.

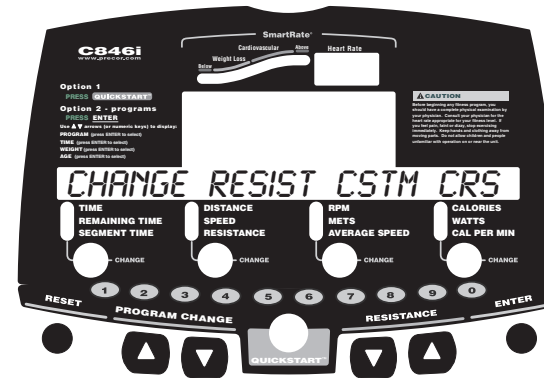

Diagram 4: Modify the Custom program

Informational Displays (C842i)

The C842i cycle provides information about its use (odometer and hour meter), as well as software version, and error log. In general, you would only access this information if directed to do so by Precor Customer Support.

These instructions guide you through all four informational displays.

Viewing the Odometer

1. At the Precor banner, press the following keys in sequence and without pause:
RESET, RESISTANCE ▼, SELECT
Numbers appear on the display as you press the associated key.
REVOLUTIONS appears on the display followed by the odometer value (number of total revolutions).
2. When you are ready, press SELECT to move to the next display (hour meter).

Viewing the Hour Meter

HOURS appears followed by the number of hours that the unit has been in use. The cycle tracks the elapsed minutes, but the value that appears is truncated to the nearest full hour.

3. When you are ready, press SELECT to move to the next display (software version).

Viewing the Software Version and Part Numbers

UPPER SW scrolls across the display followed by the upper board application software part number and version (for example, 48181-350).

4. To see the upper boot and lower boot application software version, press the SELECT key. If needed, you can move through all three—upper board, upper boot, and lower board—using the SELECT key.
5. Write the numbers below. You will need these numbers when you call Customer Support with display-related questions. This information will help rule out any software-related problems:
Upper Software P/N: _____
Upper Boot Software P/N: _____
Lower Software P/N: _____
6. When you are ready, press RESET to move to the next display (error log).

Viewing the Error Log

The first error log entry scrolls across the display. Up to ten error codes can be retrieved. If there are no errors in the log, you will see NO ERRORS displayed.

7. To view any additional error codes in the error log, use the arrow keys. Each error code specifies when it occurred, listing the odometer and hour meter values. Refer to Diagram 5.

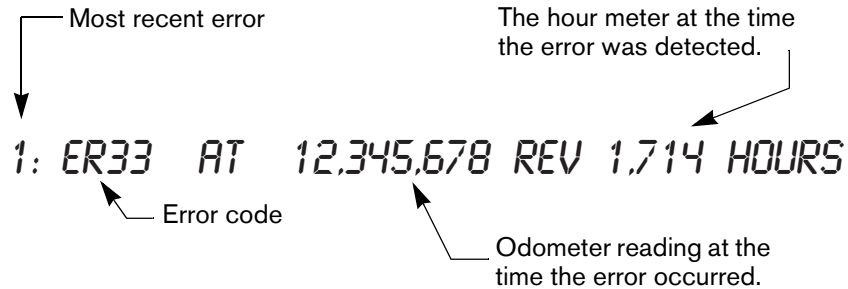

Diagram 5: Error log

8. Copy the error code information to paper so you can provide it to Customer Support if needed. Be sure to copy it exactly as shown.

9. When you no longer need the information in the error log, press QUICKSTART for at least four seconds to delete the error log. Continue to maintain light pressure on the key until the message OK appears. When the key is released, NO ERRORS appears in the display, which indicates the error log has been deleted.

Important: You cannot retrieve the error log once you have deleted it. You may want to resolve any issues you are experiencing with the cycle before clearing the error log.

10. When you are ready, press SELECT or RESET to move to the next display.

Informational Displays (C846i)

The C846i cycle provides information about its use (odometer and hour meter), as well as software version, error log, and serial number. In general, you would only access this information if directed to do so by Precor Customer Support.

These instructions guide you through all five informational displays. Pressing the ENTER key moves you through the displays. To exit, press the RESET key at any time.

Viewing the Odometer

1. At the Precor banner, press the following keys in sequence and without pause:

RESET, 6, 5

Numbers appear on the display as you press the associated key.

The odometer value (the total revolutions) appears on the display followed by the word REVOLUTIONS.

2. When you are ready, press ENTER to move to the next display (hour meter).

Viewing the Hour Meter

HOUR METER appears followed by the number of hours that the unit has been in use. The cycle tracks the elapsed minutes, but the value that appears is truncated to the nearest full hour.

3. When you are ready, press ENTER to move to the next display (software version).

Viewing the Software Version and Part Numbers

SOFTWARE VERSION appears for two seconds. UPPER APP then appears followed by the upper board application software part number and version (for example, 48181-350).

4. To see the upper boot and lower boot application software version, use the arrow keys. If needed, you can move through all three—upper board, upper boot, and lower board—using the arrow keys.
5. Write the numbers below. You will need these numbers when you call Customer Support with display-related questions. This information will help rule out any software-related problems:

Upper Application P/N: _____

Upper Boot Software P/N: _____

Lower Application P/N: _____

6. When you are ready, press ENTER to move to the next display (error log).

Viewing the Error Log

ERROR LOG appears on the display followed by the first entry in the error log if there are any errors. Up to ten error codes can be retrieved.

If there are no errors in the log, you will see NO MORE ERRORS displayed.

7. To view any additional error codes in the error log, use the arrow keys. Each error code specifies when it occurred, listing the odometer and hour meter values. Refer to Diagram 6.

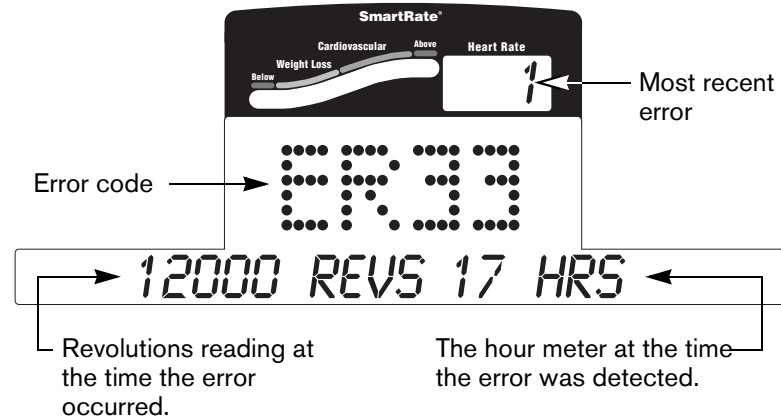

Diagram 6: Error log

8. Copy the error code information to paper so you can provide it to Customer Support if needed. Be sure to copy it exactly as shown.
9. When you no longer need the information in the error log, press QUICKSTART for at least four seconds to delete the error log. Continue to maintain light pressure on the key until the message CLEARED appears. When the key is released, 1 appears in the Heart Rate display and dashes appear in the error code display, which indicates the error log has been deleted.
***Important:** You cannot retrieve the error log once you have deleted it. You may want to resolve any issues you are experiencing with the cycle before clearing the error log.*
10. When you are ready, press SELECT (C842i) or ENTER (C846i) to move to the next display (serial number).

Displaying the Serial Number

SERIAL NUMBER appears on the display followed by the 13-digit serial number. The serial number is helpful when you contact Customer Support.

Note: If no serial number has been entered, then NO SERIAL NUMBER appears. Use the serial number found on a label on the rear cover (Diagram 1).

11. If you have not already done so, write the serial number onto the Warranty Registration card. You can also register online at www.precor.com.
12. When you are ready, press ENTER to return to the Precor banner.

User ID Entry with CSAFE Equipment

The C846i cycle is fully compatible with CSAFE protocols. When the unit is connected to a CSAFE master device and the user maintains a pedal speed above 20 revolutions per minute (RPM), the user is prompted for a user ID.

Note: If the optional power adapter is being used, then no pedaling is necessary for user ID entry.

The user ID is displayed as five zeros. The left most zero blinks indicating you starting point. The following table describes key functions while in CSAFE mode.

<i>Keypad</i>	<i>Description</i>
PROGRAM CHANGE ▲ or ▼	moves the blinking LED from column to column
RESISTANCE ▼ or ▲	changes the number value in the in the selected column
Number keypad	use the number keys to enter a user ID. The number that is pressed appears in the display and the next column begins to blink. When all five numbers are in place, the user must press ENTER to submit the user ID.
ENTER	submits the user ID. Note: User ID entry is bypassed when the user enter five zeros. No workout statistics are recorded.
RESET	resets the display to the Precor banner.

A message appears on the display and indicates when the user ID is accepted by the CSAFE master device. Then, the program prompt appears. The user has the option to choose QUICKSTART or select a program and begin exercising.

Note: If the user's pedal speed drops below 20 RPM and the optional power adapter is not installed, a prompt PEDAL FASTER appears. If the pedal speed remains below the 20 RPM threshold for the next twenty seconds, the CSAFE connection is terminated. The word RESETTING may appear on the display while the cycle disconnects from the CSAFE device.

To review information about CSAFE specifications, visit the website at: www.fitlinx.com/csafe

If you have questions or need technical support, refer to *Obtaining Service*.

Maintenance

It is important to perform the minor maintenance tasks described in this section. Failure to maintain the cycle as described here could void the Precor Limited Warranty.

DANGER To reduce the risk of electrical shock, always unplug the unit from its optional power adapter before performing any maintenance tasks.

Daily Inspection

Look and listen for slipping belts, loose fasteners, unusual noises, and any other indications that the equipment may be in need of service. If you notice any of these, obtain service.

Important: If you determine that the cycle needs service, move it away from the usual exercising area. Place an "out of service" sign on it and make sure all users know that the cycle needs service.

To order parts or to contact a Precor authorized service provider in your area, refer to *Obtaining Service*.

Daily Cleaning

Precor recommends the cycle be cleaned before and after each workout. Use a damp, soft cloth to clean all exposed surfaces.

Cleaning the Equipment

Most of the working mechanisms are protected inside the covers. However, for efficient operation, the cycle relies on low friction. To keep the friction low, the cycle pedals and internal mechanisms must be as clean as possible.

Frequently vacuum the floor underneath the unit to prevent the accumulation of dust and dirt, which can affect the smooth operation of the unit. Clean the grooves on the pedals using a soft nylon scrub brush.

CAUTION: Do not use any acidic cleaners. Doing so will weaken the paint or powder coatings and void the Precor Limited Warranty. Never pour water or spray liquids on any part of the cycle. Allow the cycle to dry completely before using.

Storing the Chest Strap

Store the chest strap where dust and dirt cannot accumulate on it, such as a closet or drawer. Be sure to keep the chest strap protected from extremes in temperature. Do not store it in an area that may be exposed to temperatures below 32° F (0° C).

To clean the chest strap, use a sponge or soft cloth dampened in mild soap and water. Dry the surface thoroughly with a clean towel.

Long-Term Storage

When the cycle is not in use for any length of time, ensure that the optional power adapter is unplugged from its power source and is positioned so that it and the power cord will not become damaged or interfere with people or other equipment.

Adjusting the Seat

To avoid knee strain, it is important that you inform your patrons about positioning the seat properly.

To check for proper seat position, be sure users take the following steps:

1. Sit on the seat.
2. Place each foot on a pedal (inside the pedal straps).
3. Observe the position of each leg. The extended leg should be slightly bent at the knee in a 10 to 15 degree angle.

If seat adjustment is needed, refer to the following instructions.

Upright Seat Adjustment

1. Dismount and hold the post underneath the seat with one hand while you pull out the seat post adjustment pin (pop pin) with the other hand. Refer to Diagram 7.
2. Slide the seat post up or down into the desired position and then release the seat post adjustment pin.
3. Before sitting on the cycle, press down firmly on the seat to make sure it does not slip. Check that the pop pin is secure inside the seat post.

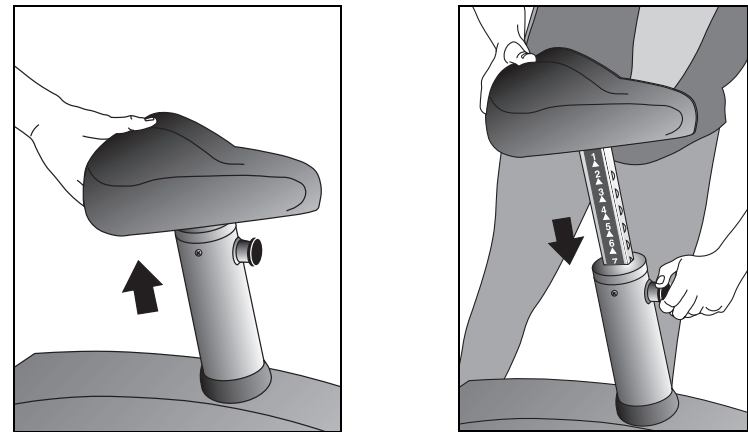

Diagram 7: Adjusting the seat on the C842i Upright Cycle

Recumbent Seat Adjustment

1. Sit on the seat with your feet in the pedals.
2. Pull the seat adjustment handle up while you bend your knees and slide the seat forward or backward along the seat rail. Refer to Diagram 8.

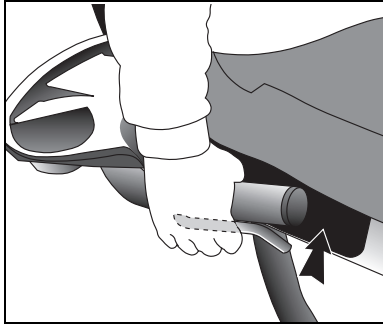

Diagram 8: Adjusting the seat on the C842i Recumbent Cycle

3. Align the seat with one of the marks on the seat rail and release the handle.
4. Try to slide the seat along the seat rail. Make sure the seat does not move before beginning your exercise session.

Upright Cycles: Adjusting the Seat Tilt

To adjust the seat tilt on upright cycles, take the following steps.

1. Use a $1\frac{1}{16}$ -inch (17 mm) box-end wrench or crescent wrench to loosen the nut beneath the seat. Refer to Diagram 9.

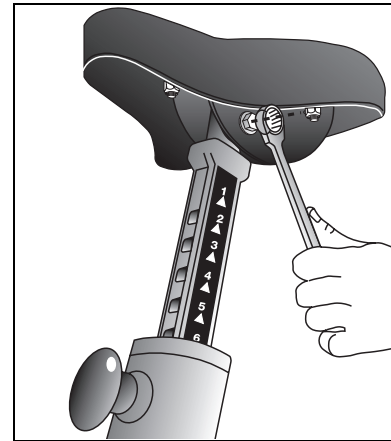

Diagram 9: Loosen nut to adjust seat tilt

2. Adjust the seat tilt (forward or backward) as shown in Diagram 10.

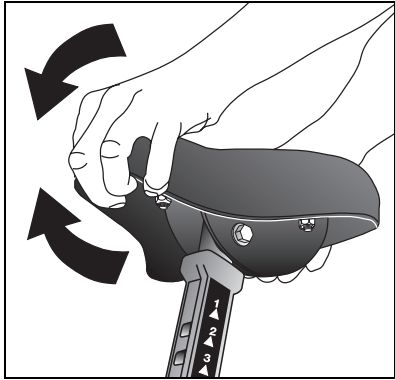

Diagram 10: Tilt the seat forward or backward

3. Wrench tighten the nut
4. Apply pressure to the seat and make sure that it does not move. Readjust and retighten the nut, if needed.

Recumbent Cycles: Realigning the Seat

If the seat rocks side-to-side, you need to realign the center wheel underneath the seat. Adjustment screws are located on the left side of the seat rail.

To remove seat wobble (side to side movement), take the following steps.

1. Obtain a $\frac{3}{16}$ -inch and $\frac{5}{16}$ -inch hex key.

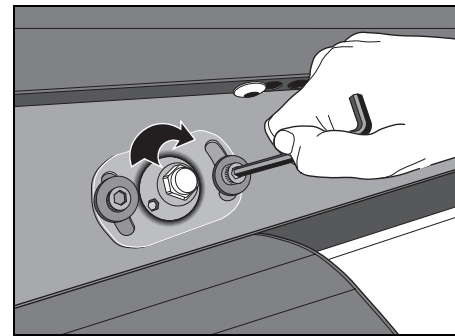

Diagram 11: Loosen the two adjustment screws

2. Use the $\frac{3}{16}$ -inch hex key to loosen the two adjustment screws as shown in Diagram 11.

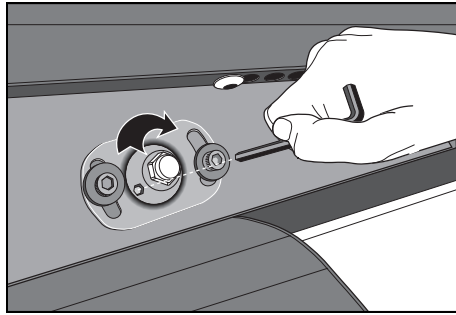

Diagram 12: Wheel lock adjustment

3. Use the $\frac{5}{16}$ -inch hex key to turn the wheel lock adjustment key clockwise $\frac{1}{4}$ turn. Refer to Diagram 12. This process realigns the center wheel inside the top rail. Leave the $\frac{5}{16}$ -inch hex key in place while you tighten the adjustment screws with the $\frac{3}{16}$ -inch hex key.
4. Remove the hex keys and check that the seat no longer rocks side-to-side. If the rocking movement continues, you need to repeat steps 2 and 3.

Using the Optional Power Adapter

If you purchase the optional power adapter, you must also purchase the internal cable kit. The kit supplies the cable, bracket, and fasteners that connect the power adapter to the lower electronics board.

CAUTION: The internal cable kit must be installed by authorized service personnel. Do not attempt installation on your own as you could void the Precor Limited Warranty. For more information, refer to *Obtaining Service*.

Once the internal cable kit is installed, you can plug the optional power adapter into the unit as shown in Diagram 13. Plug the opposite end into the appropriate power source for your unit (110/120v or 220/240v).

Important: When the optional power adapter is in use, ensure that the power cord does not create a safety hazard. Keep it out of the way of traffic and moving parts. If the power cord or power adapter is damaged it should be replaced.

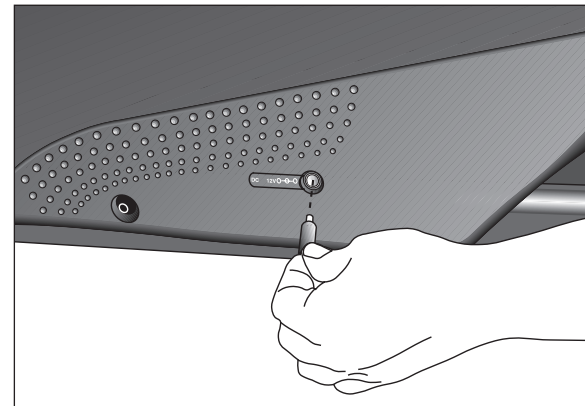

Diagram 13: Optional power adapter receptacle

Troubleshooting Error Codes

If any error codes appear in the display, call an authorized service person for assistance. Refer to *Obtaining Service*.

Troubleshooting Heart Rate

Table 1 may help you understand and troubleshoot erratic heart rate readings.

Important: A heart rate can only be detected when the Precor heart rate receiver is properly installed in the display and the user maintains a minimum of 20 RPM. A user must also wear the chest strap on the C842i or grasp both touch-sensitive handlebar grips on the C846i.

Table 1. Erratic heart rate readings

<i>What appears on the display</i>	<i>Cause</i>	<i>What to Do</i>
Nothing	The heart rate receiver is not installed or it has been disconnected.	Call Customer Support. Refer to <i>Obtaining Service</i> .
---	A signal is being detected through the chest strap, but a valid heart rate is not yet established.	Be sure that the chest strap is moist, centered, and in direct contact with the user's skin. Wait a few moments to see if the user's heart rate appears.

<i>What appears on the display</i>	<i>Cause</i>	<i>What to Do</i>
Pulsing Hr	A signal is being detected through the touch-sensitive handlebar grips, but a valid heart rate is not yet established.	Ask the user to grasp both handlebar grips (C846i only) until his or her heart rate appears.

Note: To conduct electrical impulses from a user's heart, both touch-sensitive handlebar grips (C846i) must be grasped firmly for five to ten seconds. Usually, the concentration of salts in a person's perspiration provides enough conductivity to transmit a signal to the receiver in the display console. However, because of body chemistry or erratic heartbeats, some people cannot use the touch-sensitive heart rate feature. A chest strap may provide better results.

Precor Commercial Equipment Limited Warranty

PLEASE READ THESE WARRANTY TERMS AND CONDITIONS CAREFULLY BEFORE USING YOUR PRECOR INCORPORATED PRODUCT. BY USING THE EQUIPMENT, YOU ARE CONSENTING TO BE BOUND BY THE FOLLOWING WARRANTY TERMS AND CONDITIONS.

Limited Warranty.

Precor Incorporated warrants all new Precor products to be free from defects in materials and manufacture for the warranty periods set forth below. The warranty periods commence on the invoice date of the original purchase. This warranty applies only against defects discovered within the warranty period and extends only to the original purchaser of the product. Parts repaired or replaced under the terms of this warranty will be warranted for the remainder of the original warranty period only. To claim under this warranty, the buyer must notify Precor or your authorized Precor dealer within 30 days after the date of discovery of any nonconformity and make the affected product available for inspection by Precor or its service representative. Precor's obligations under this warranty are limited as set forth below.

Warranty Periods and Coverage.

Commercial Cardiovascular Products, also known as C-Series Products, (excluding StretchTrainer, Strength Products).

- Seven years frame, five years touch sensor display housing, two years parts, one year labor.
- For treadmills, five years motor fan, three years drive motor.
- For self-powered ellipticals and bikes, one year battery.
- For InSite, one year parts and labor.
- Labor coverage for options as defined below.

StretchTrainer

Five years frame, two years parts, 90 days upholstery, no labor.

Strength Products (S3.45 and S3.25 only)

Ten years frame; three years bearings, guide rods, cams, pulleys; one year belts, cables, hand grips, miscellaneous parts; 90 days upholstery; no labor.

Options / Accessories / Battery-powered or Self-Operated Devices

Many options or accessories have components that are connected internally or mounted inside the electronic console. The following guidelines determine the warranty for these components. If the internal components are installed by the factory or by an authorized dealer as part of the original sale and delivery, they have a warranty that is identical to the warranty of the equipment in which they are connected or mounted. If the internal components are not installed by the factory or by an authorized dealer as part of the original sale and delivery, they have a 90 days parts and labor limited warranty. All components that are not internally connected have a 90 days parts only limited warranty. Satisfactory proof of purchase is required in all cases.

Conditions and Restrictions.

This warranty is valid only in accordance with the conditions set forth below:

1. The warranty applies to the Precor product only while
 - a. it remains in the possession of the original purchaser and proof of purchase is demonstrated,
 - b. it has not been subjected to accident, misuse, abuse, improper service, or non-Precor modification.
 - c. claims are made within the warranty period.
2. Certain products are warranted for standard commercial use only (defined as use in non-fee paying clubs or facilities and less than 6 hours daily use. Unapproved use voids the warranty. Current standard commercial products include C936i, C932i, EFX524i, EFX534i.).
3. This warranty does not cover damage or equipment failure caused by electrical wiring not in compliance with electrical codes or Precor owner's manual specifications, or failure to provide reasonable and necessary maintenance as outlined in the owner's manual.
4. Except in Canada, Precor does not pay labor outside the United States.
5. Warranties outside the United States and Canada may vary. Please contact your local Dealer for details.

This Limited Warranty shall not apply to:

1. Software (PROM) version upgrades.
2. Normal wear and tear, consumables and cosmetic items, including, but not limited to the following: grips, seats, and labels.
3. Repairs performed on Precor equipment missing a serial number or with a serial tag that has been altered or defaced.
4. Service calls to correct installation of the equipment or instruct owners on how to use the equipment.
5. Pickup and delivery involved with repairs.
6. Any labor costs incurred beyond the applicable labor warranty period.

Disclaimer and Release.

The warranties provided herein are the exclusive warranties given by Precor and supersede any prior, contrary or additional representations, whether oral or written. ANY IMPLIED WARRANTIES, INCLUDING THE WARRANTY OF MERCHANTABILITY OR FITNESS FOR A PARTICULAR PURPOSE THAT APPLY TO ANY PARTS DESCRIBED ABOVE ARE LIMITED IN DURATION TO THE PERIODS OF EXPRESS WARRANTIES GIVEN ABOVE FOR THOSE SAME PARTS. PRECOR HEREBY DISCLAIMS AND EXCLUDES THOSE WARRANTIES THEREAFTER. Some States do not allow limitations on how long an implied warranty lasts, so the above limitation may not apply to you. PRECOR ALSO HEREBY DISCLAIMS AND EXCLUDES ALL OTHER OBLIGATIONS OR LIABILITIES, EXPRESS OR IMPLIED, ARISING BY LAW OR OTHERWISE, WITH RESPECT TO ANY NONCONFORMANCE OR DEFECT IN ANY PRODUCT, INCLUDING BUT NOT LIMITED TO: (A) ANY OBLIGATION, LIABILITY, RIGHT, CLAIM OR REMEDY IN TORT, WHETHER OR NOT ARISING FROM THE NEGLIGENCE OF PRECOR OR ITS SUPPLIERS (WHETHER ACTIVE, PASSIVE OR IMPUTED); AND (B) ANY OBLIGATION, LIABILITY, RIGHT, CLAIM OR REMEDY FOR LOSS OF OR DAMAGE TO ANY EQUIPMENT. This disclaimer and release shall apply even if the express warranty set forth above fails of its essential purpose.

Exclusive Remedies.

For any product described above that fails to conform to its warranty, Precor will provide, at their option, one of the following: (1) repair; (2) replacement; or (3) refund of the purchase price. Precor Limited Warranty service may be obtained by contacting the authorized dealer from whom you purchased the item. Precor compensates Servicicers for warranty trips within their normal service area to repair commercial equipment at the customer's location. You may be charged a trip charge outside the service area. THESE SHALL BE THE SOLE AND EXCLUSIVE REMEDIES OF THE BUYER FOR ANY BREACH OF WARRANTY.

EXCLUSION OF CONSEQUENTIAL AND INCIDENTAL DAMAGES.

PRECOR AND/OR ITS SUPPLIERS SHALL HAVE NO OBLIGATION OR LIABILITY, WHETHER ARISING IN CONTRACT (INCLUDING WARRANTY), TORT (INCLUDING ACTIVE, PASSIVE, OR IMPUTED NEGLIGENCE AND STRICT LIABILITY), OR OTHERWISE, FOR DAMAGE TO THE EQUIPMENT, PROPERTY DAMAGE, LOSS OF USE, REVENUE OR PROFIT, COST OF CAPITAL, COST OF SUBSTITUTE EQUIPMENT, ADDITIONAL COSTS INCURRED BY BUYER (BY WAY OF CORRECTION OR OTHERWISE) OR ANY OTHER INCIDENTAL, SPECIAL, INDIRECT, OR CONSEQUENTIAL DAMAGES, WHETHER RESULTING FROM NONDELIVERY OR FROM THE USE, MISUSE OR INABILITY TO USE THE PRODUCT. This exclusion applies even if the above warranty fails of its essential purposes and regardless of whether such damages are sought for breach of warranty, breach of contract, negligence, or strict liability in tort or under any other legal theory. Some states do not allow the exclusion or limitation of incidental or consequential damages, so the above limitation may not apply to you.

This warranty gives you specific legal rights, and you may also have other rights, which vary from state to state.

Complete this portion and keep for your records.

Purchased From: _____
(Dealer or store name)

Phone Number: _____
(Dealer or store telephone number)

Product/Model: _____
(For example: EFX534i or C966i)

Serial Number: _____
(The serial number is found on the shipping container.)

Effective 01 December, 2004
P/N 36286-111

Thank You and Welcome to Precor



We are confident that you will be pleased with your purchase and that your new Precor equipment will help satisfy your customers' fitness needs, while helping you meet your business goals.

To allow us to serve you better, please take a few moments to complete and return your warranty registration.

YOU MAY ALSO REGISTER ONLINE AT

www.precor.com/warranty

If you have questions or need additional information, contact your local dealer or call Precor Commercial Products Customer Support at 888-665-4404.

Fold along dotted line and tape closed before mailing.

COMM.

PRECOR[®] USA
Precor Incorporated
20031 142nd Avenue NE
PO Box 7202
Woodinville, WA 98072-4002

PLACE
STAMP
HERE

TELL US ABOUT YOUR NEW PRECOR PRODUCTS

Date of Purchase:

Month	Day	Year
-------	-----	------

Purchased from (Dealer name):

--

Product Serial Number(s):

--

The serial number is located on the shipping box and on the product.

--

--

Add additional sheets of paper or register online at www.precor.com/warranty

Please indicate the type and number of products purchased:

- #: _____ Elliptical Fitness CrossTrainer (EFX®)
- #: _____ Treadmill #: _____ Stair Climber
- #: _____ Cycle #: _____ Strength Station

TELL US ABOUT YOUR FACILITY

--

Mr. Name of Facility

Mrs. Contact Person — First Name Last Name

--

Facility Address Apt./Suite

--

City State Zip Code

--

Area Code Facility Telephone Number

--

Your Business Email Address

How many members do you have?

- Less than 100 100 – 500 500 – 1000 1000 – 2000 2001 +

What percentage of floor space do you allocate for cardio equipment?

- 0% to 20% 20% to 40% 40% to 60% 60% to 80% 80% to 100%

What type of equipment makes up your cardio offering (check all that apply)?

- Treadmills Ellipticals Cycles Stair Climbers Rowing Machines Other

What other brands of cardio equipment do you currently offer (check all that apply):

- Life Fitness True Cybex StarTrac Other

What other Precor equipment do you currently offer (check all that apply):

TELL US ABOUT YOUR PURCHASE

- EFX Cycle StretchTrainer™
- Treadmill Stair Climber Strength Machine Other

Which best describes this purchase (check all that apply):

- First Precor product type brand owned
- Replaces a Precor product of the same
- Replaces same type of product – different
- Enhancement to equipment already

How did you FIRST become aware of this product (choose only one):

Please detach and mail in the warranty registration within ten days of purchase.

C842i/C846i Commercial Cycles

Product Specifications

	C842i Upright	C842i Recumbent	C846i Upright	C846i Recumbent
Length:	50 in (127 cm)	57 in (145 cm)	54 in (137 cm)	56 in (142 cm)
Width	24 in (61 cm)	24 in (61 cm)	24 in (62 cm) ¹	24 in (62 cm)
Height	60 in (152 cm)	48 in (122 cm)	53 in (135 cm)	48 in (122 cm)
Weight	130 lb (59 kg)	160 lb (73 kg)	127 lb (57 kg)	152 lb (68 kg)
Shipping weight	190 lb (86 kg)	220 lb (100 kg)	142 lb (64 kg)	167 lb (75 kg)
Power	Self-powered	Self-powered	Self-powered	Self-powered
Resistance levels	1–20	1–20	1–25	1–25
Frame	Powder-coated steel	Powder-coated steel	Powder-coated steel	Powder-coated steel
Regulatory Approvals	FCC, ETL, CE	FCC, ETL, CE	FCC, ETL, CE	FCC, ETL, CE

Product Features

	C842i	C846i
CSAFE Compatible		✓
Heart Rate Telemetry	✓	✓
QuickStart™	✓	✓
SmartRate®	✓	✓
Touch Heart Rate		✓
Touch Sensitive Display		✓

PRECOR^{USA}
move beyond®

Precor Incorporated
20031 142nd Ave NE
P.O. Box 7202
Woodinville, WA USA 98072-4002

Precor, C, CrossRamp, EFX, M, Move Beyond, and SmartRate are registered trademarks of Precor Incorporated. Crosstrainer, QuickStart, and StretchTrainer are trademarks of Precor Incorporated.
Copyright 2005 Precor Incorporated.
Specifications subject to change without notice.
www.precor.com

NOTICE:

Precor is widely recognized for its innovative, award winning designs of exercise equipment. Precor aggressively seeks U.S. and foreign patents for both the mechanical construction and the visual aspects of its product design. Any party contemplating the use of Precor's product designs is hereby forewarned that Precor considers the unauthorized appropriation of its proprietary rights to be a very serious matter. Precor will vigorously pursue all unauthorized appropriation of its proprietary rights.

Programs

	C842i	C846i
Manual	✓	✓
Calorie Goal		✓
Cross Country	✓	✓
Distance Goal		✓
Fitness Test*		✓
Heart Rate Control*	✓	✓
Hill Climb	✓	✓
Interval 1	✓	✓
Interval 2		✓
Interval 3		✓
Random		✓
Resistance Custom		✓
Watts Control		✓
Weight Loss	✓	✓

Display Readouts

	C842i	C846i
Calories	✓	✓
Calories Per Minute		✓
Distance	✓	✓
Heart Rate*	✓	✓
METS		✓
Profile	✓	✓
Remaining Time		✓
Resistance Levels	1–20	1–25
RPM	✓	✓
Segment Time		✓
SmartRate*	✓	✓
Speed	✓	✓
Time	✓	✓
Watts	✓	✓
Workout Summary	✓	✓

* Use of a chest strap or the touch-sensitive handrail grips is required.



C842i/C846i POM 48816-101, en
Warranty # 36287-111, en
Registration Card# 45622-101, en
15 July 2005

User's Reference Manual

C842i

Commercial Cycle



C842i Recumbent

PRECOR[®]_{USA}
move beyond[®]

Important Safety Instructions

When using the C842i cycle, always take basic precautions, including the following:

- Read all instructions before using the cycle. These instructions are written to ensure your safety and to protect the unit.
- Before beginning any fitness program, see your physician for a complete physical examination.

Il est conseillé de subir un examen médical complet avant d'entreprendre tout programme d'exercice. Si vous avez des étourdissements ou des faiblesses, arrêtez les exercices immédiatement.

- Do not allow children or those unfamiliar with its operation on or near the cycle. Do not leave children unsupervised around the unit.
- Wear proper exercise clothing and shoes for your workout and avoid loose clothing. Do not wear shoes with heels or leather soles. Tie long hair back.
- Use care when getting on or off the cycle. Use the handlebar for stability.

- Keep your body and head facing forward. Never attempt to turn around on the cycle.
- Do not rock the unit. Do not stand on the handlebars, display console, or plastic covers.
- Never place your hands or feet in the path of the pedals because injury may occur to you or damage may occur to the equipment.
- Do not overexert yourself or work to exhaustion. If you feel any pain or abnormal symptoms, stop your workout immediately and consult your physician.

Obtaining Service

The club owner or manager can help you with most questions regarding the cycle. For additional information about product operation or exercise routines, see the Precor website at www.precor.com.

Table of Contents

Important Safety Instructions	1	Workout Options	11
Obtaining Service	1	Choosing QUICKSTART	12
Cycle Features	3	Selecting a Program	12
Self-Powered Features	3	Changing the Program during an Exercise Session	13
Using the Handlebars	3	Cooling Down After a Workout	14
Adjusting the Seat	3	Pausing During a Workout or the Cool-Down Period	14
Heart Rate Features	4	Ending a Workout	15
Guidelines	4	Programs	16
Using SmartRate	5	Choosing a Program	16
Exercise to Your Target Heart Rate	6	Program Tips	17
Heart Rate Analysis	6	Manual (MANL) Program	17
Display Console	7	Interval (INTV) Program	18
Keypad	9	Weight Loss (WTLS) Program	19
Changing the Display Features		Hill Climb (HILL) Program	20
Using the SELECT Key	10	Cross Country (XTR) Program	20
		Heart Rate Control (HRC) Program	21

Cycle Features

The cycle is equipped with certain items that, when used properly, help sustain an enjoyable workout. These items include:

- Self-powered features
- Handlebars
- Seat Adjustments

Important: Before exercising, review the Important Safety Instructions found at the beginning of this manual.

Self-Powered Features

The cycle does not require an electrical power connection. It has an internal battery that is recharged every time you exercise for a reasonable period of time. A pedaling speed above 20 revolutions per minute (RPM) must be maintained for several seconds before the Precor banner appears on the display. Once the banner appears, you can press QUICKSTART or SELECT to begin exercising. For more information, refer to *Workout Options*.

Using the Handlebars

To maintain your balance on the C842i upright cycle, always grasp a handlebar when you step on or off the cycle, and when you use the keypad. On the recumbent cycle, use the handlebar to maintain your comfort.

Adjusting the Seat

Information on how to adjust the seat and seat tilt is found in the *Product Owner's Manual*. Refer to that manual or ask club personnel to show you the proper techniques.

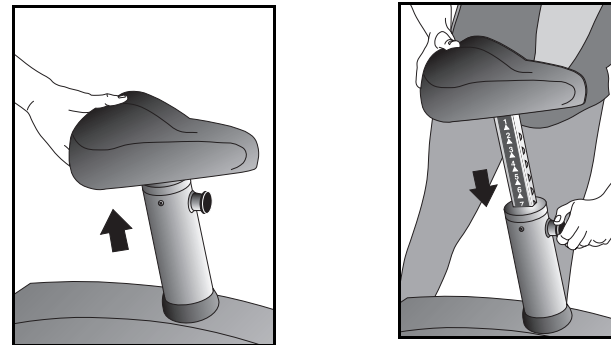

Diagram 1: Adjusting the seat on the C842i Upright Cycle

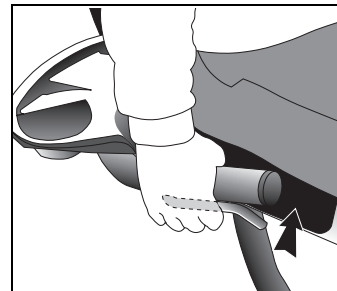

Diagram 2: Adjusting the seat on the C842i Recumbent Cycle

Heart Rate Features



Heart rate and SmartRate® features are available when you wear the chest strap. When a heartbeat is detected, a number (representing your heart rate) appears in the display when the HEART RATE LED is lit. The SmartRate LED pulses and indicates your target zone.

The chest strap is an optional purchase item for the C842i cycle. Check with the club or facility manager to see if a chest strap is available.

Guidelines

Read the following before using the heart rate feature.

- Consult your physician before engaging in any vigorous exercise. Do not use the heart rate features until authorized by your physician.
- Know your heart rate (pulse) and your physician-recommended heart rate target zone. Individual heart rates vary according to several physiological factors and may not correspond directly with Diagram 3.

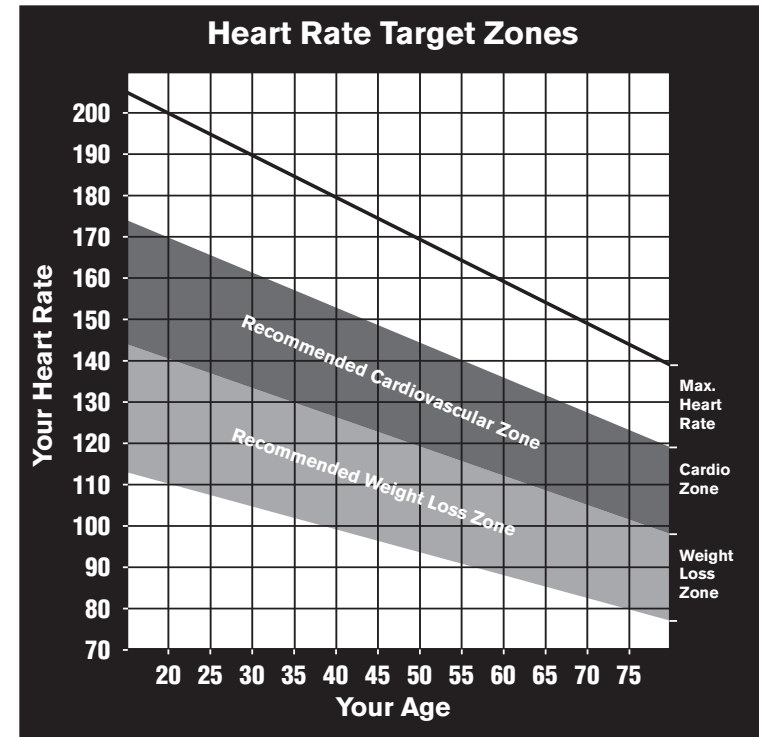

Diagram 3: Heart rate target zones

- The calculation used for the heart rate target zone is:
Low range: $(220 \text{ minus your age})$ multiplied by 55%
High range: $(220 \text{ minus your age})$ multiplied by 85%

- After you put on the chest strap, face the display console for a minimum of 15 seconds. This allows the receiver in the console to recognize the signal from the chest strap.
- If three dashes (– – –) appear on the display, the cycle is detecting a signal, but has not yet determined your heart rate. Make sure the chest strap is positioned properly around your chest and against your skin.
- Always face forward on the cycle and use the handlebars for balance.

Using SmartRate

The SmartRate feature helps you monitor and maintain your heart rate in the target zone best suited to your specific needs. When you wear the chest strap, a blinking LED appears on the SmartRate display. The blinking LED indicates the zone that your heart rate is in, either weight loss or cardiovascular.

The SmartRate indicator lights do not appear when:

- You press QUICKSTART at the Precor banner.
- You bypass the AGE prompt.
- You do not wear or improperly position the chest strap.

Note: If you are having difficulties with the chest strap, ask the club or facilities manager how to properly adjust the chest strap.

For the ideal weight loss range, the first, second, and third SmartRate LEDs are lit and the fourth LED blinks. If you are exercising in the cardiovascular zone, the fifth or sixth LED should be blinking. Refer to Table 1.

Table 1. Heart rate target zones and SmartRate LEDs

<i>Heart Rate Target Zone Percent</i>	<i>LED Lit</i>	<i>LED Blinking</i>
Below 55	First	First
55 to 60	First	Second
61 to 66	First through second	Third
67 to 72	First through third	Fourth
73 to 79	First through fourth	Fifth
80 to 85	First through fifth	Sixth
Above 85	First through sixth	Seventh

CAUTION: Your heart rate should never exceed 85% of your maximum aerobic heart rate. If it does, the seventh SmartRate LED begins to blink. Immediately reduce your pedaling speed (RPM) or the resistance to return your heart rate to your physician-recommended target zone.

Exercise to Your Target Heart Rate

The cycle includes a program that lets you exercise based on a specified heart rate. You set your target heart rate at the beginning. As you exercise, the Heart Rate Program monitors your heart rate and automatically maintains it within a few beats per minute (bpm) of your selected target. Your actual heart rate appears in the display when the HEART RATE LED is lit.

To use this program, select HRC. You must also wear the chest strap so the program can monitor your heart rate throughout the exercise session. For more information, refer to *Programs*.

Heart Rate Analysis

Every time you complete a program using the chest strap, the cycle provides a heart rate analysis after the workout summary.

Your average heart rate appears followed by the maximum heart rate achieved during your workout. A third display, indicates the amount of time your heart rate remained between the target zones shown.

Note: The average is based on how often your heart rate signal is received while exercising.

Display Console

Center display: Initially shows the Precor banner. It changes to the program profile. A blinking column in the profile indicates your position.

SmartRate display: LEDs light in this column when the SmartRate feature is activated. Follow the LEDs to monitor your heart rate and maintain it in your target zone.

LEDs: Light and clarify what workout statistics appear on the display.

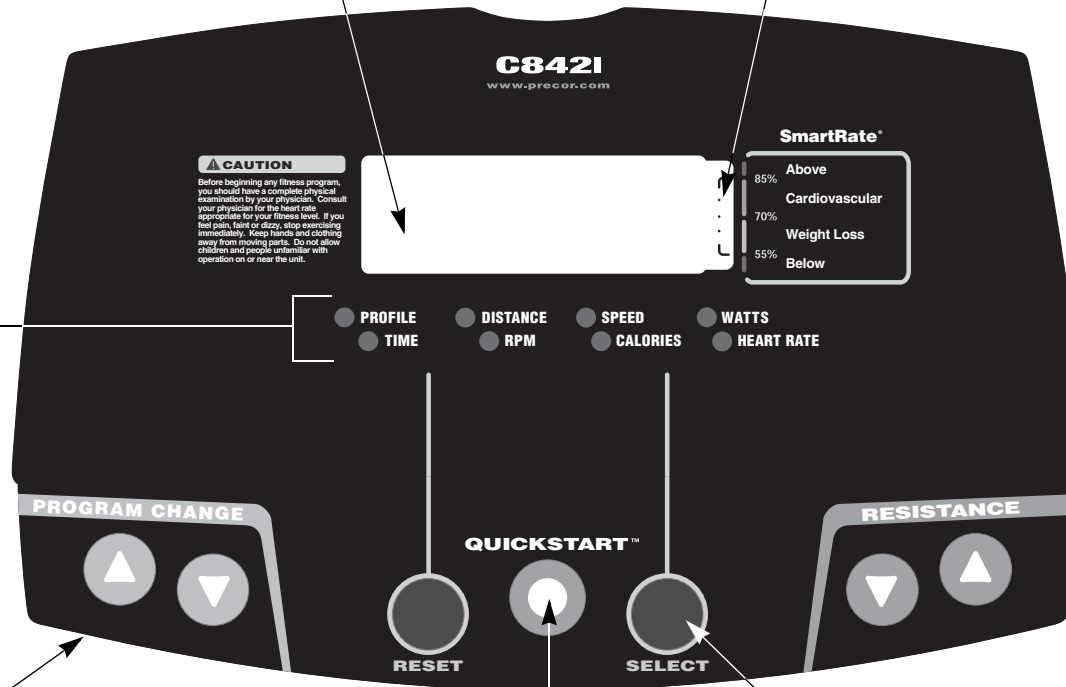

- Keypad:** Use the keypad to:
- Control your workout session
 - Answer prompts prior to starting a program
 - Determine what display features appear
 - Change the program
 - Prematurely end a program
 - Adjust the resistance

SELECT key: Enter data during the setup phase and customize the display during a workout.

QUICKSTART: Press QUICKSTART to begin your workout immediately. It lets you bypass the setup prompts.

The center display shows the following information. This information is shown in alphabetic order.

CALORIES—displays the estimated cumulative number of calories burned. The calorie calculation is derived from the pedaling speed and your weight. An accurate weight entry results in a more accurate calorie count. When using QUICKSTART and a weight has not been specified, the default weight is 150 pounds (68 kilograms).

DISTANCE—shows the linear distance in miles or kilometers. The distance is calculated based on your current pedaling speed (RPM) and resistance setting.

HEART RATE—displays your heart rate. If you are wearing the chest strap, the display shows your heart rate when the LED is lit.

In the Heart Rate Control Program (HRC), the RESISTANCE arrow keys affect the target heart rate. Refer to HRC Program.

PROFILE—appears on the display and corresponds to the program you selected. As you continue your workout, a blinking column indicates your position in the program.

In most programs, the resistance setting affects the column height in the program profile as shown in Diagram 4.

If the profile is only one row high or resistance change is minimal, then markers (•••••) appear occasionally and provide a sense of movement through the program.

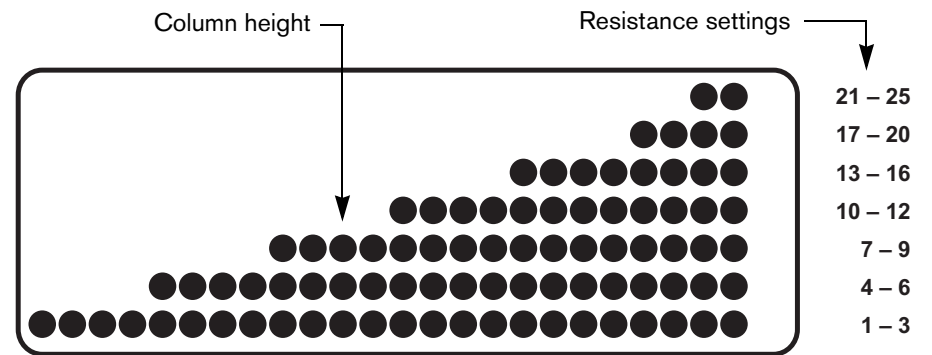

Diagram 4: Column height in the program profile

RPM—indicates the number of pedal revolutions completed per minute. The value can range between 20 and 150.

SPEED—shows the linear distance in miles or kilometers. The distance is calculated based on your current pedaling speed (RPM) and resistance setting.

TIME—displays workout time in minutes and seconds; however, when you exceed 60 minutes during a single workout, the TIME display converts to hours and minutes. For programs with a workout time limit, the TIME display shows the amount of time remaining. For programs without a workout time limit, the TIME display indicates the amount of time you have been exercising.

Note: The club can place limits on workout time. If the facility allows the NO LIMIT program time option and you select it, the TIME display indicates the amount of time you have been exercising.

WATTS—displays the current mechanical energy generated by the unit.

Keypad

Use the keypad to enter your workout session selections. Keys on the keypad respond to the slightest touch. Use gentle pressure on the keys as you exercise.

Note: During the setup phase, pressing the RESISTANCE arrow keys will not affect the resistance. However, the arrow keys do affect what appears on the display. Refer to *Selecting a Program*.

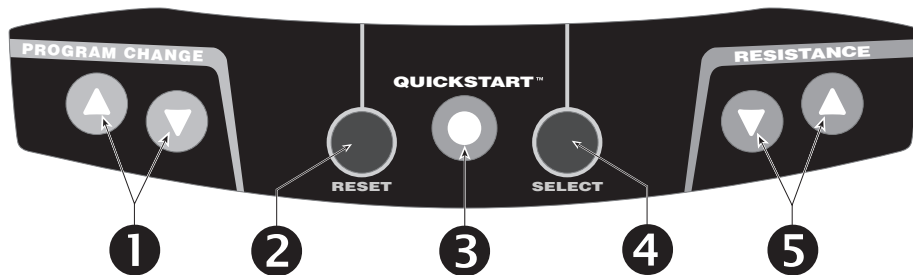

1 **PROGRAM CHANGE ▲▼:** You can use the PROGRAM CHANGE ▲▼ keys to switch to a different program during an exercise session. Tap a PROGRAM CHANGE arrow key to view the current program. Press a PROGRAM CHANGE arrow key for a few seconds to select a new program and the profile changes accordingly. For more information, refer to *Changing the Program during an Exercise Session*.

Important: You cannot make a mid-session change to or from the Weight Loss Program using the PROGRAM CHANGE arrow keys.

2 **RESET:** During your exercise session or from pause mode, press the RESET key to display a WORKOUT SUMMARY. Press RESET again to return to the Precor banner.

Important: The optional power adapter must be connected before you can pause your exercise session for more than 30 seconds.

3 **QUICKSTART:** Press QUICKSTART to bypass the setup prompts and start your workout immediately using the Manual Program. Refer to *Choosing QUICKSTART*.

4 **SELECT:** The SELECT key has two functions:

- To select a program
- To change features displayed during your exercise session. Refer to *Changing the Display Features Using the SELECT Key*.

5 **RESISTANCE ▼▲:** Press and hold the RESISTANCE arrow keys to increase or decrease the resistance you feel against the pedals. The RESISTANCE ▼▲ keys affect the brake and let you set a resistance between 1 and 25.

Changing the Display Features Using the **SELECT** Key

When exercising on the cycle, you can view the display features by pressing the **SELECT** key.

Initially, the LED next to the word **PROFILE** is lit and the program profile is displayed. Every time you press the **SELECT** key, the next indicator (**TIME**, **DISTANCE**, and so on) lights and the featured information appears on the display.

Workout Options

CAUTION: Before beginning any fitness program, see your physician for a complete physical examination. Know your physician-recommended heart rate target zone.

1. Sit on the seat and place your feet inside the pedal straps.



2. When you are comfortably situated, begin pedaling.

3. Select one of the following options:

Option...	Steps...
To start exercising immediately	<ul style="list-style-type: none"> • Use the QUICKSTART key. • Refer to <i>Choosing QUICKSTART</i>.
To select a program and workout time, and specify your weight and age	<ul style="list-style-type: none"> • Use the SELECT key. • Refer to <i>Selecting a Program</i>.
To select a different program during an exercise session	<ul style="list-style-type: none"> • Use the PROGRAM CHANGE arrow keys. • Refer to <i>Changing the Program during an Exercise Session</i>.

Choosing QUICKSTART

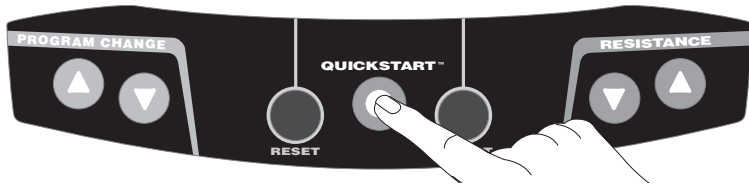

1. Press QUICKSTART while the banner is scrolling to bypass the setup prompts and access the Manual Program.

QUICKSTART applies the following defaults:

Prompts	Default Value
Program	Manual (MANL)
Time	Club setting or 30 minutes
Weight	150 lb (68 kg)
Age	0

To use the SmartRate feature, you need to specify your age and wear the chest strap. (Refer to *Heart Rate Features*.) In this case, press SELECT and follow the setup prompts to enter your age. Press QUICKSTART after your age is displayed.

2. Use the RESISTANCE ▼▲ keys to change the resistance.

Note: To select a different program during your exercise session, use the PROGRAM CHANGE ▲▼ keys. Refer to *Changing the Program during an Exercise Session*.

Selecting a Program

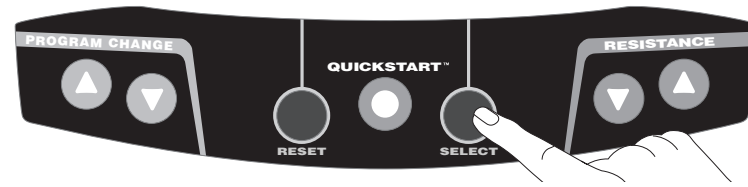

1. At the scrolling Precor banner, press SELECT, and then press the arrow keys to cycle through the available programs.

Table 2. Available Programs

Program	Program Abbreviation
Manual	MANL
Interval	INTV
Weight Loss	WTLS
Hill Climb	HILL
Cross Country	XTR
Heart Rate Control	HRC

2. Choose the program you want, and then press SELECT.
3. A workout time blinks in the lower display. The display indicates the club limit or the default time of 30 minutes. Press the arrow keys to select a workout time (between 1 and 99 minutes) and then press SELECT.

Note: If the club allows it, you can select an unlimited workout time by choosing NO LIMIT and then pressing SELECT.

4. Select your weight (1–999) and then your age (1–99).

- To change a value (program, workout time, weight, or age) that you have already entered, press RESET and reselect the information.

Note: You can press QUICKSTART after any of the prompts (program name, workout time, weight, or age entry). QUICKSTART applies user preferences and uses the club's default settings for any prompts skipped.

- Use the RESISTANCE ▼▲ keys to change the pedal resistance.

Changing the Program during an Exercise Session

While exercising or during the cool-down period, you can select a different program (except Weight Loss) by touching the PROGRAM CHANGE ▲▼ keys. Accumulated workout statistics and workout time are transferred to the new program selection.

Note: Continue pedaling and keep the RPM above 20 while you adjust to your new selection.

To select a new program, take the following steps:

- Press a PROGRAM CHANGE ▲▼ key. The display indicates the program that is currently running. Continue to press either PROGRAM CHANGE ▲ or ▼ key to display a different program.

Note: While selecting a new program, your exercise session is momentarily suspended. The LEDs next to the workout statistics are not lit. If QUICKSTART or SELECT are not pressed within five seconds, the cycle resumes your exercise session without making any program changes.

- Select one of the following options:

Option...	Steps...
To select the displayed program and carry forward all aspects of the previous program (workout time, statistics, weight, age, etc.)	<ul style="list-style-type: none"> Use the QUICKSTART key.
To select the displayed program and add or change information by answering program-specific prompts	<ul style="list-style-type: none"> Use the SELECT key.

Note: When the club time limit is set to expire within one minute, the PROGRAM CHANGE ▲▼ keys are disabled.

Cooling Down After a Workout

Incorporate a cool-down period into your workout to help lower your heart rate and minimize muscle stiffness or soreness.

When you complete a program with a time limit, you automatically enter a cool-down period. The Manual Program profile appears in the display and resistance reduces by 20%. To change the resistance, press the RESISTANCE arrow keys.

A workout summary appears at the end of the cool-down period. See *Ending a Workout*.

Important: *If you specify an unlimited workout time, remember to incorporate a cool-down period at the end of your workout. If you exit a program before completing it, the cool-down period is bypassed.*

To prematurely end the cool-down period, do the following:

1. Continue pedaling.
2. Press RESET to view the WORKOUT SUMMARY.
3. Press RESET again to return to the Precor banner.

Pausing During a Workout or the Cool-Down Period

If you stop pedaling anytime during your exercise session or during a cool-down period, the cycle begins a 30-second shutdown procedure. You cannot pause beyond the 30-second limit unless the club has the optional power adapter attached to the unit.

When the optional power adapter is attached, you can pause for a set time, usually two minutes. If you do not resume pedaling during that time, the display returns to the banner.

1. To pause, stop pedaling.
2. To resume exercising from pause mode, begin pedaling.

Ending a Workout

CAUTION: On the C842i upright cycle, hold on to a stationary handrail when you dismount.

1. Slow your pedaling speed (RPM) when you complete the cool-down period.
2. To view your workout summary, continue pedaling above 20 RPM.

The WORKOUT SUMMARY appears and shows your cumulative workout statistics including warm-up and cool-down periods. Other information including RPM, calories per minute, and watts reset to zero. You can review your workout statistics as long as you continue pedaling.

Note: A heart rate analysis appears if you wear the chest strap during your workout. For more information, refer to *Heart Rate Analysis*.

3. End your workout by pressing the RESET key and return to the Precor banner.

Note: If the optional power adapter is attached, you do not have to continue pedaling to view your workout statistics. When you complete the cool-down period, the WORKOUT SUMMARY appears. Press RESET to return to the Precor banner.

Programs

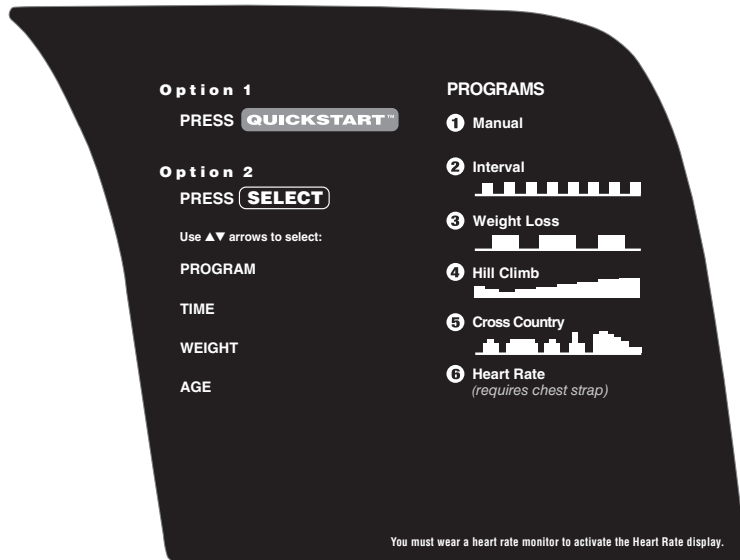

Diagram 5: C842i program label

This section describes the programs printed on the C842i display console.

Choosing a Program

Choosing a program depends on your goals. If you are a beginner or returning to regular exercise, you can start a cardio-conditioning program to slowly return your body to a comfortable level of exercise. If you have been exercising and feel that you have an intermediate or advanced fitness level, you probably have established goals. The Precor website (www.precor.com) can give you many ideas about fitness workouts and advice from the experts.

Several workout choices on the cycle are preprogrammed with recommendations for the resistance and alternating rest or work intervals. You always have the option to override the suggested levels with the exception of the Heart Rate Control Program.

If your level of exertion becomes too great, reduce your pedaling speed (RPM) or use the arrow keys to override the resistance in each upcoming column in the program profile. If you use the RESISTANCE arrow keys, the profile changes accordingly.

Program Tips

- While exercising, your pedaling speed (RPM) needs to remain above 20 RPM. Dropping below 20 RPM causes the cycle to shut down to conserve battery power. The cycle displays a 30-second countdown before it shuts off. If you pedal above 20 RPM during the countdown period, you can resume exercising where you left off.
- A blinking column tracks the progress that you make during a program.
- The club can set limits for workout, pause, and cool-down times.

Manual (MANL) Program



You control the resistance settings when you use the Manual Program. The profile begins as a flat line. Use the RESISTANCE arrow keys to adjust the resistance. The program profile reflects changes in all subsequent columns. The blinking column indicates your position in the program.

If you press QUICKSTART at the banner and access the Manual Program, the workout time is set at the club limit or 30 minutes (whichever time is less).

To use the SmartRate feature, you need to specify your age and wear a chest strap. Refer to *Selecting a Program*.

Interval (INTV) Program

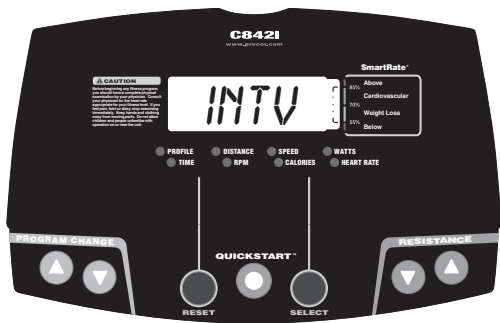

The Interval Program is among the best for conditioning your cardiovascular system. The program raises and lowers your level of exertion repeatedly in one minute intervals. Refer to Diagram 6.

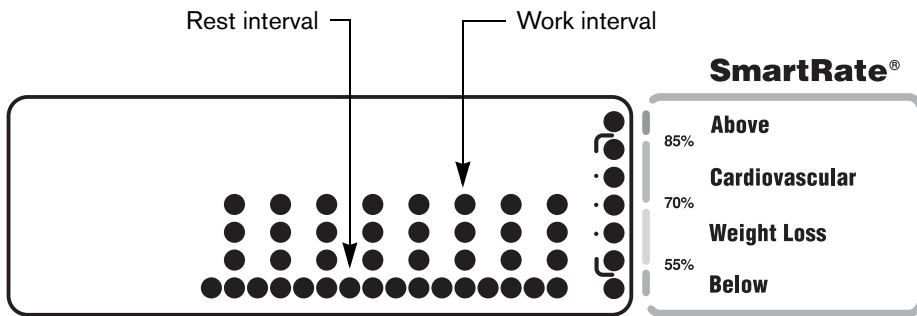

Diagram 6: Rest and work profile in the Interval Program

When you begin the program, the resistance for the rest and work intervals is preprogrammed. The settings are repeated throughout the program unless you change them.

The initial resistance settings are:

- Rest interval resistance: 1
- Work interval resistance: 4

To change the settings, press the appropriate arrow key and continue. The changes are applied to the remaining intervals. The display lets you know when the resistance is about to change, and indicates the levels of the next interval.

Weight Loss (WTLS) Program

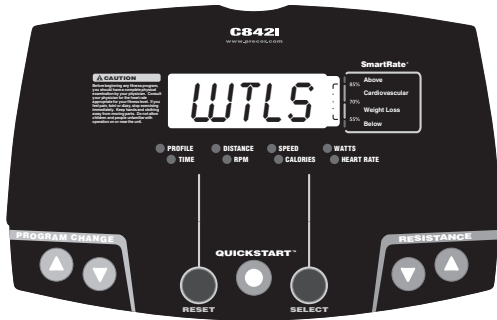

With the Weight Loss Program, the workout time is fixed at 28 minutes and consists of seven 4-minute intervals. You are not prompted for a workout time. Use the RESISTANCE arrow keys to change the resistance for the rest or work interval. Refer to Diagram 7. When you make changes, the program repeats the settings for the remaining intervals.

The display lets you know when the resistance levels are about to change.

For the ideal weight loss range, your heart rate should be between 55% and 70% of your maximum aerobic heart rate. If you wear the chest strap, you can use SmartRate as a visual cue.

- Set a comfortable pedaling speed (RPM) and then adjust the resistance.
- Maintain a level of exertion so that the first yellow LED blinks in the SmartRate display during rest intervals.
- During the work intervals, increase your level of exertion so that the first green LED blinks.

For more information about the SmartRate display, refer to *Using SmartRate*.

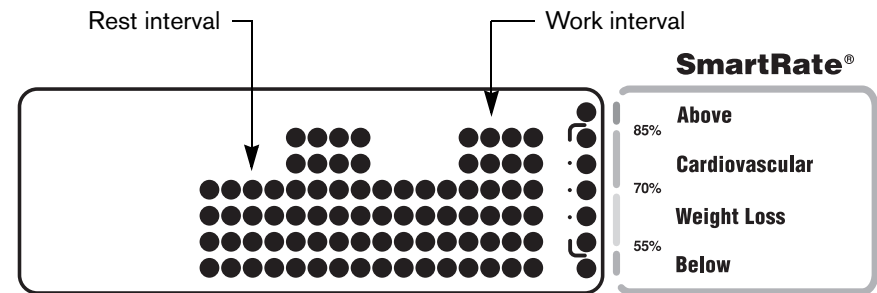

Diagram 7: Rest and work intervals

Hill Climb (HILL) Program



The Hill Climb Program is a variable resistance program that works the leg muscle groups. The resistance in the Hill Climb Program is preprogrammed. To override the resistance settings for each column, press the RESISTANCE arrow keys. The changes raise or lower the columns on the remaining portion of the program profile.

Cross Country (XTR) Program

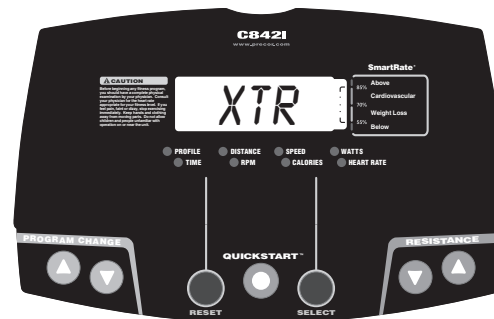

The Cross Country Program is a variable resistance program. It is similar to the Hill Climb Program, but provides a different preprogrammed resistance profile. To override the resistance settings for each column, press the RESISTANCE arrow keys. The changes raise or lower the columns on the remaining portion of the program profile.

Heart Rate Control (HRC) Program



The Heart Rate Control Program lets you set a target for your heart rate. The program adjusts the resistance to maintain your heart rate within two beats per minute of the target heart rate while you exercise. To use this program, you must wear the chest strap so the program can monitor your heart rate throughout the session.

During your workout, the number that represents your heart rate appears when the HEART RATE LED is lit.

For information about understanding your target heart rate, refer to *Heart Rate Features*.

Important: Consult your physician to determine the appropriate target heart rate for your age and fitness level. If your physician recommends a different target heart rate than the one that appears on the display, use the appropriate RESISTANCE arrow keys to change the target heart rate once you finish the warm-up period. Do not exercise over the recommended range.

Warm-Up Period

The cycle provides a 3-minute warm-up period. During this time, you may change the resistance.

Note: If your heart rate moves into the target heart rate zone $[(220 \text{ minus age}) \times 70\%]$ during the 3-minute warm-up period, the warm-up period ends and the Heart Rate Control Program begins.

Using the Heart Rate Control Program

When you access the Heart Rate Control Program, the following occurs:

- The cycle automatically adjusts the resistance to keep your heart rate at the selected target. Pressing the RESISTANCE arrow keys no longer affects the resistance, but does change the target heart rate. Check the SmartRate display to see if you are maintaining your preferred zone (weight loss or cardiovascular). Your actual heart rate appears in the display when the HEART RATE LED is lit.

Important: Maintain a constant pedaling speed. Automatic adjustments to the resistance cannot take place if you drop below 20 revolutions per minute (RPM).

- You can change the target heart rate, but doing so affects the unit's ability to maintain your target heart rate in the preferred zone. It takes time for the cycle to readjust the resistance so that your heart rate remains on target.
- When you complete the program, remember to add a cool-down period.

Note: If you are having difficulty with the heart rate features, talk to your club representative.

Notes:

Notes:



Precor Incorporated
20031 142nd Ave NE
P.O. Box 7202
Woodinville, WA USA 98072-4002

Precor, C, CrossRamp, EFX, M, Move Beyond, and SmartRate are registered trademarks of Precor Incorporated. Crosstrainer, QuickStart, and StretchTrainer are trademarks of Precor Incorporated.
Copyright 2005 Precor Incorporated.
Specifications subject to change without notice.
www.precor.com

NOTICE:

Precor is widely recognized for its innovative, award winning designs of exercise equipment. Precor aggressively seeks U.S. and foreign patents for both the mechanical construction and the visual aspects of its product design. Any party contemplating the use of Precor's product designs is hereby forewarned that Precor considers the unauthorized appropriation of its proprietary rights to be a very serious matter. Precor will vigorously pursue all unauthorized appropriation of its proprietary rights.



C842i URM 48817-101, en
15 July 2005

Assembly Guide



C846i

PRECOR[®]
USA
move beyond[®]

C842i

C846i

Commercial Upright Cycle

Thank you for choosing Precor. For proper installation, please read this guide thoroughly and follow the assembly instructions. If you do not assemble the C846i/C842i Upright Cycle according to these guidelines, you could void the Precor Limited Warranty.

Obtaining Service

You should not attempt to service the cycle except for maintenance tasks as described in the *Product Owner's Manual*. If any items are missing, contact your dealer. Should you need more information regarding customer support numbers or a list of Precor authorized service centers, visit the Precor website at www.precor.com/contact.

Unpacking the Equipment

The unit is shipped on one pallet. Ask for help from two or more people to unpack and assemble the cycle.

Required Tools



- Wire tie cutter
- One $\frac{3}{4}$ -inch combination wrench (box-end or crescent)

Installation Requirements

Follow these installation requirements when assembling the unit:

- **Assemble the unit near the location where you plan to use it.**
- **Provide ample space around the unit.**
Open space around the unit allows for easier access.
- **Set up the cycle on a solid, flat surface.**
A smooth, flat surface under the unit helps keep it level. A level unit has fewer malfunctions.
- **Open the box and assemble the components in the sequence presented in this guide.**
- **Leave room for adjustments.**
Tighten fasteners (bolts, nuts, and screws) so the unit is stable, but leave room for adjustments. Do not fully tighten fasteners until instructed to do so.
- **If you plan to move the unit, obtain help and use a hand truck. Do not grasp any plastic parts while lifting or moving the unit. The plastic parts are not capable of supporting the weight of the unit and they may break.**

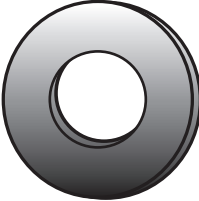
Hardware Kit (not to scale)

Fasteners	Quantity
 A long, silver-colored hex head cap screw with a hexagonal head and a threaded shaft.	(A) Hex head cap screw (5-inch) 2
 A circular, silver-colored washer with a central hole and a flat, slightly beveled surface.	(B) Washer (1/2-inch) 2
 A short, silver-colored buttonhead screw with a rounded head and a threaded shaft.	(C) Buttonhead screw (1 3/4-inch) <i>Important: You can discard the buttonhead screws because they are not used in the C846i/C842i Upright Cycle assembly.</i> 4

2 – Rubber bib (D)

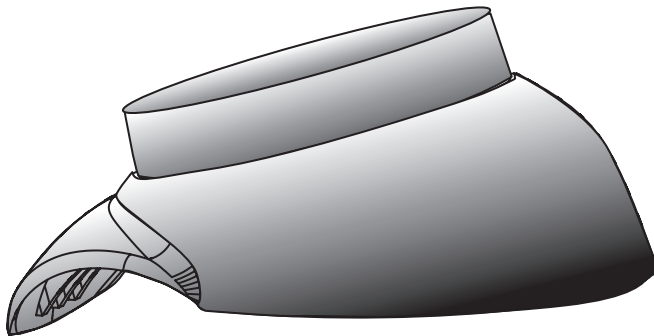

1 – 3/16-inch hex key (E)



Assembly Steps

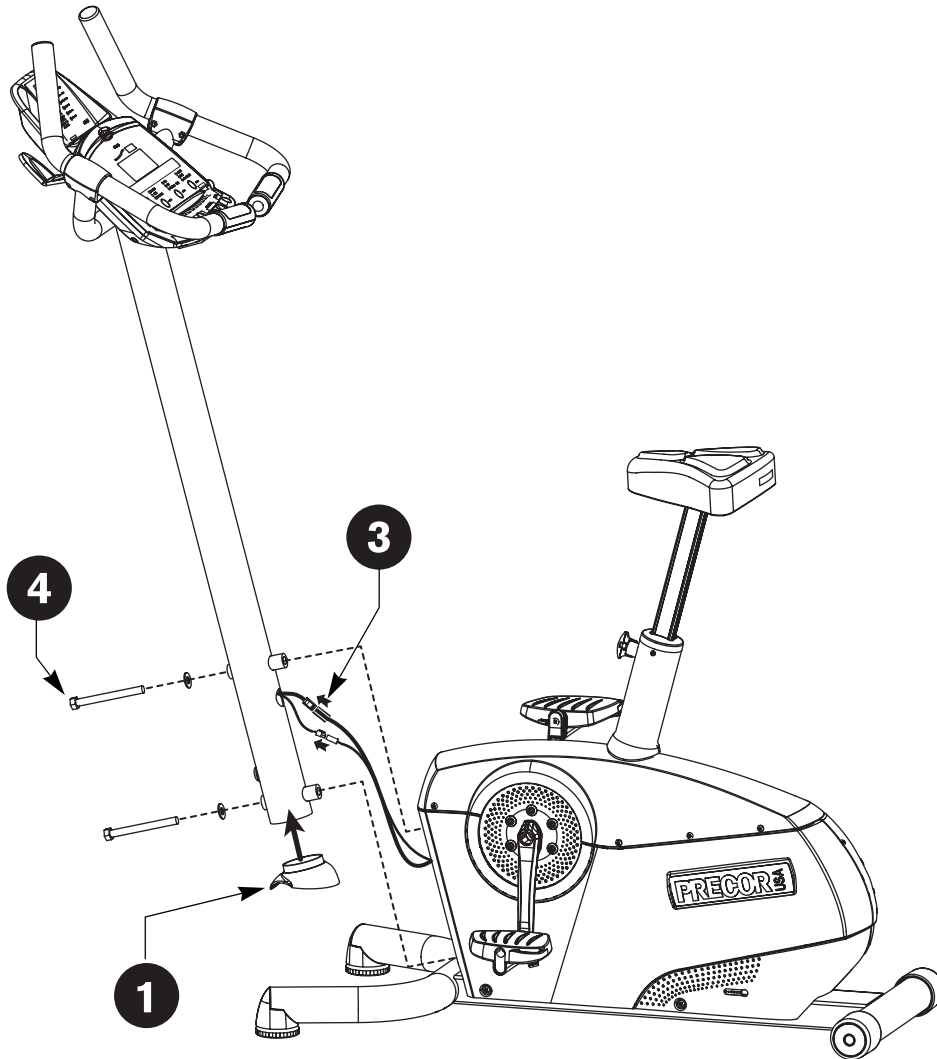

- 1 Position the rubber bib so the flared side faces the floor (as shown in the illustration) and slide it into the base of the upright support.
- 2 Place the upright support on the base crossbar so that the lip of the rubber bib rests on the crossbar and is parallel to the floor.
- 3 Have your assistant hold the upright support while you connect the two cables. Place excess cable inside the base assembly.

Note: The C842i has only one cable connection.

Important: Do not stretch, crimp, or damage the cables. Cables damaged by improper installation will not be covered by the Precor Limited Warranty.

CAUTION: Before tightening the screws, make sure the cables are not in danger of being crimped or pinched.

- 4 Secure the upright support to the base assembly using two hex head cap screws (A) and two washers (B). Alternately tighten each screw using a $\frac{3}{4}$ -inch box-end or crescent wrench. Check the upright support to make sure it is securely fastened.
- 5 Adjust the seat. Pull up on the seat to raise it. To lower the seat, hold onto the seat pad while you pull out the pop pin. Slide the seat into position and reinsert the pop pin.

CAUTION: Always apply downward pressure to the seat to make sure it is securely in place before a user sits on the

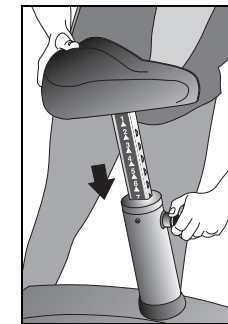
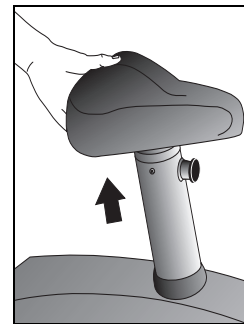

6

Level the cycle. Before allowing users on the cycle, make sure it does not wobble from side to side.

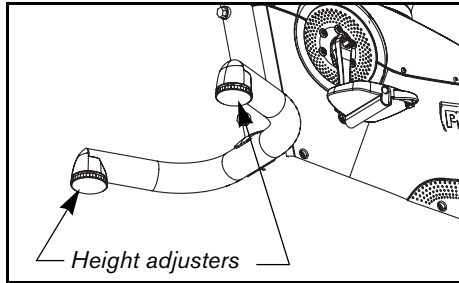

To remove any side-to-side movement, ask your assistant to tip the unit on its side so that you can locate the two height adjusters on the front crossbar.

Turn the height adjusters until the unit does not wobble or rock from side to side.

Important: If the unit is placed on a slightly uneven surface, rotating the height adjusters can help, but will not compensate for extremely uneven surfaces.

When you are finished making adjustments, ask your assistant to gently lower the unit to the floor.

7

Verify that the C846i heart rate display is operational.

1. Sit on the cycle. When you are comfortably situated, begin pedaling. A pedaling above 20 revolutions per minute (RPM) must be maintained for several seconds.
2. Grasp both touch-sensitive grips on the handlebars.
3. Look at the Heart Rate display. The letters **Hr** should be blinking. After a few seconds, a number appears indicating your heart rate.

Note: If the display remains blank, refer to the *Product Owner's Manual* for troubleshooting tips. Instructions regarding the chest strap are also found in the *Product Owner's Manual*.

PRECOR^{USA}
move beyond[®]

Precor Incorporated
20031 142nd Avenue NE
P.O. Box 7202
Woodinville, WA USA 98072-4002

Download from [Www.Somanuals.com](http://www.Somanuals.com). All Manuals Search And Download.



©2005 Precor Incorporated
www.precor.com
C846i/C842i Upright AG 48579-101, en
15 July 2005

Free Manuals Download Website

<http://myh66.com>

<http://usermanuals.us>

<http://www.somanuals.com>

<http://www.4manuals.cc>

<http://www.manual-lib.com>

<http://www.404manual.com>

<http://www.luxmanual.com>

<http://aubethermostatmanual.com>

Golf course search by state

<http://golfingnear.com>

Email search by domain

<http://emailbydomain.com>

Auto manuals search

<http://auto.somanuals.com>

TV manuals search

<http://tv.somanuals.com>