

# User's Reference Manual

## C100i

Commercial Adaptive Motion Trainer



**PRECOR**<sup>®</sup>  
USA  
move beyond<sup>®</sup>



## Important Safety Instructions

When using the AMT™ 100i, always take basic precautions, including the following:

- Read all instructions before using the AMT. These instructions are written for your safety and to protect the unit.
- Take time to discuss proper safety and exercise equipment etiquette with the club or facility manager.
- Before beginning any fitness program, see your physician for a complete physical examination.  
*Il est conseillé de subir un examen médical complet avant d'entreprendre tout programme d'exercice. Si vous avez des étourdissements ou des faiblesses, arrêtez les exercices immédiatement.*
- Do not allow children or those unfamiliar with its operation on or near the AMT. Do not leave children unsupervised around the unit.
- Wear proper exercise clothing and shoes for your workout and avoid loose clothing. Do not wear shoes with heels or leather soles. Check the soles of your shoes and remove any dirt and embedded stones. Tie long hair back.
- Use care when getting on or off the AMT. Stand on the rear pedestal and then place one foot in the lower foot plate. Grasp an arm or a stationary handlebar for stability while you step into the other foot plate.
- The rear pedestal provides an elevated platform for stepping on and off the AMT. It also indicates the buffer zone that people must stay clear of when someone is using the AMT.

- Keep your body and head facing forward. Never attempt to turn around on the AMT.
- For safety, hold on to a stationary handlebar while using the AMT.
- Do not rock the unit. Do not stand on the handrail(s), display console, or covers.
- Never place your hands or feet in the path of the foot plates because injury may occur to you or damage may occur to the unit.
- Do not overexert yourself or work to exhaustion. If you feel any pain or abnormal symptoms, stop your workout immediately and consult your physician.

## Obtaining Service

The club owner or facility manager can help you with most questions regarding the AMT. For additional information about product operation or exercise routines, refer to the Precor web site at [www.precor.com](http://www.precor.com).

# Table of Contents

<b>Important Safety Instructions .....</b>	<b>1</b>	<b>Workout Options .....</b>	<b>16</b>
Obtaining Service .....	1	Choosing QUICKSTART .....	17
<b>AMT Features .....</b>	<b>3</b>	Selecting a Program .....	18
Self-Powered Features .....	3	Storing Workout Statistics .....	19
Using the Handrails .....	3	Setting Display Preferences Before Exercising .....	20
Moving Handlebars Support the Total Body Workout .....	3	Cooling Down After a Workout .....	21
<b>Heart Rate Features .....</b>	<b>4</b>	Pausing During a Workout or the	
Important Use and Safety Information .....	4	Cool-Down Period .....	21
Using the Heart Rate		Ending a Workout .....	22
Touch-Sensitive Handlebar Grips .....	5	<b>Programs .....</b>	<b>23</b>
Using SmartRate .....	6	Choosing a Program .....	23
Exercise to Your Target Heart Rate .....	7	Program Tips .....	23
Heart Rate Analysis .....	7	Manual Program .....	24
<b>Display Console .....</b>	<b>8</b>	Interval Program .....	24
More Information about the Upper Display .....	9	Basic HRC Program .....	25
Stride Length Display .....	10	Fat Burner Program .....	26
More Information about the Center Display .....	10	<b>Exercise Session .....</b>	<b>27</b>
More Information about the Lower Display .....	11	Changing Programs in Mid-session .....	27
Keypads .....	12	Changing the Workout Time .....	28
		Adjusting Program Goals .....	28
		Changing Your Workout Display Options .....	29
		Changing the Units of Measure .....	30
		Selecting a Language .....	31

# AMT Features

The AMT is equipped with certain items that, when used properly, help sustain an enjoyable workout. These items include:

- Self-powered features
- Touch-sensitive handlebar grips
- Moving handlebars for a total body workout

**Important:** Before exercising, review the *Important Safety Instructions* found at the beginning of this manual.

## Self-Powered Features

The AMT does not require an electrical power connection. It has an internal battery that is recharged every time you exercise for a reasonable period of time. Moving the foot plates causes the Precor banner to appear. You can press QUICKSTART or select a program to begin exercising. For more information, refer to *Workout Options*.

If you do not move the foot plates, then a 30-second shutdown process begins. Dots appear in the center display and all key presses are ignored. If no foot plate movement is detected, the dots steadily disappear as the countdown continues.

To resume exercising where you left off, move the foot plates before the dots disappear from the display.

## Using the Handrails

To maintain your balance, always grasp a handrail. Hold on to a handrail when you step on or off the foot plates and when you use the keypads.

To learn more about the touch-sensitive handlebar grips, refer to *Heart Rate Features*.

## Moving Handlebars Support the Total Body Workout

The handlebars on the AMT provide an upper-body workout which helps increase cardiovascular fitness. By adding the total body movement to your cross training workout, you are actually increasing your work effort and enhancing your overall fitness level.

# Heart Rate Features

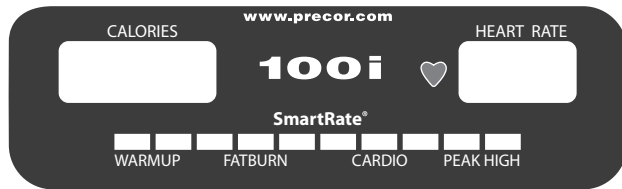

Heart rate and SmartRate® features are available when you wear the chest strap or grasp both touch-sensitive handlebar grips. When a heartbeat is detected, the HEART RATE display shows your heart rate and, if your age has been entered, the SmartRate LED pulses and indicates your target zone.

## Important Use and Safety Information

Read the following before using the heart rate or SmartRate features.

- Consult your physician before engaging in any vigorous exercise. Do not use the heart rate programs until authorized by your physician.
- Know your heart rate and your physician-recommended heart rate target zone. Individual heart rates vary according to several physiological factors and may not correspond directly with Diagram 1.
- Always face forward on the AMT and use the stationary handlebars for balance.
- Maintain a consistent stride rate while exercising. Find a comfortable stride rate above 56 strides per minute. Dropping below the minimum strides per minute causes the AMT to shut down.

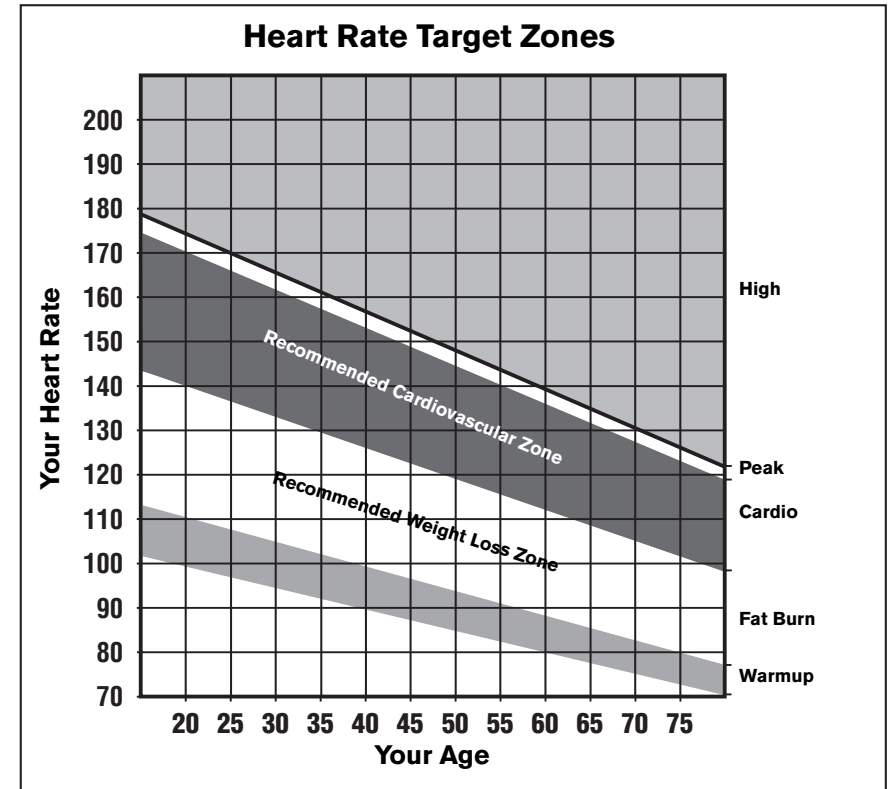

Diagram 1: Heart rate target zones

- The calculation used for the heart rate target zone is: (220 minus your age) multiplied by a percent.

For example:

Low range: (220 minus your age) multiplied by 55%

High range: (220 minus your age) multiplied by 85%

Refer to Table 1 in *Using SmartRate*.

- After you put on the chest strap, face the display console for a minimum of 15 seconds. This allows the receiver in the console to recognize the signal from the chest strap.
- If three dashes (— — —) appear on the display, the AMT is detecting a signal, but has not yet determined your heart rate. Make sure the chest strap is positioned properly around your chest and against your skin.
- If you prefer to use the touch-sensitive handlebar grips, grasp both and wait five to ten seconds. Make sure both hands are moist (not dry).
- When a signal is detected, a number flashes in the HEART RATE display and indicates your heart rate.

## Using the Heart Rate Touch-Sensitive Handlebar Grips

While exercising, you must grasp both touch-sensitive handlebar grips for a minimum of five to ten seconds to transmit your heart rate to the display. Refer to Diagram 2.

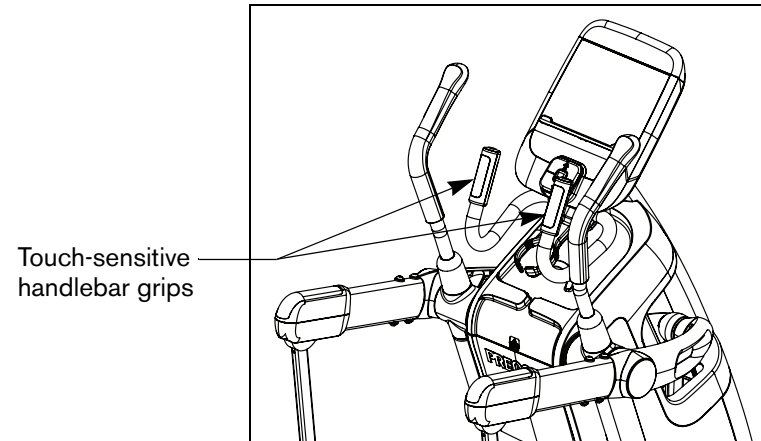

**Diagram 2: Touch-sensitive handlebar grips**

Usually, the concentration of salts in a person's perspiration provides enough conductivity to transmit a signal to the receiver inside the display console. However, some people, because of body chemistry or erratic heart beats, cannot use the touch-sensitive handlebar grips on the AMT. A chest strap may provide better results.

**Important:** While exercising, do not wear a chest strap and grasp the touch-sensitive handlebar grips at the same time. Using both features may cause erratic heart rate readings.

## Using SmartRate

The SmartRate feature helps you monitor and maintain your heart rate in the target zone best suited to your specific needs. When the AMT detects a heart rate, a single LED blinks and indicates the zone that your heart rate is in.

**Important:** To use the SmartRate feature, you must enter your age during the setup phase of your exercise session.

The 10 LEDs in the SmartRate display are color-coded. Pulsating orange LEDs indicate you are exercising outside the recommended heart rate target zone. Green LEDs indicate when you are exercising within the recommended fat burn or cardio fitness zones.

Table 1 shows the percents used in calculating the heart rate target zones. While your heart rate remains within these zones, the corresponding light blinks and provide a visual cue.

The calculation used to determine your maximum aerobic heart rate is (220 minus your age). When you multiply it by the percent indicated in Table 1, you can understand the relationship between the pulsating LED and your target heart rate.

**CAUTION:** Your heart rate should never exceed 85% of your maximum aerobic heart rate or go above PEAK. If it does, immediately reduce your strides per minute or adjust the resistance to return your heart rate to your physician-recommended target zone.

**Table 1. Heart rate target zones and SmartRate LEDs**

<i>Heart Rate Zone Percent</i>	<i>LED Lit</i>	<i>LED Blinking</i>	<i>Zone Label</i>
Below 50	First	Orange	WARMUP
50 to 54	Second	Orange	WARMUP
55 to 59	Third	Green	FAT BURN
60 to 64	Fourth	Green	FAT BURN
65 to 69	Fifth	Green	FAT BURN
70 to 74	Sixth	Green	CARDIO
75 to 79	Seventh	Green	CARDIO
80 to 84	Eighth	Green	CARDIO
85 to 87	Ninth	Orange	PEAK
Above 87	Tenth	Orange	HIGH

The SmartRate indicator lights do not blink when:

- You do not wear or improperly position the chest strap. Or, you fail to grasp both touch-sensitive handlebar grips for five to ten seconds.
- You do not enter your age when prompted after you select a program.

For example, pressing QUICKSTART at the Precor banner causes the Manual Program to begin. Your age has not been entered and is considered a null value. An LED does not blink in the SmartRate display because the appropriate calculations have not been made.

**Note:** To remedy this situation after pressing QUICKSTART, press MANUAL and then OK. Follow the prompts to enter your weight and age.



## Exercise to Your Target Heart Rate

A heart rate receiver is an integral part of the display so you can monitor your heart rate while exercising. If you wear a chest strap or grasp both touch-sensitive handlebar grips, your heart rate (beats per minute) appears on the display.

The Precor web site ([www.precor.com](http://www.precor.com)) has several suggestions for workouts with varying levels of intensity. It provides many workout details that include the appropriate target heart rate.

The AMT includes a heart rate program that lets you exercise based on a specified target heart rate. As you exercise, the program monitors your heart rate and automatically maintains it within a few beats per minute of your selected target. To use this program, press the PROGRAMS - HEART RATE key. For more information, refer to *Programs*.

## Heart Rate Analysis

Every time you complete a program using the chest strap or touch-sensitive handlebar grips, the display provides a heart rate analysis after the workout summary.

Your average heart rate appears followed by the maximum heart rate achieved during your workout. A third display appears, if you entered your age, and indicates the amount of time your heart rate remained between the target zones shown.

The heart rate analysis is based on how often your heart rate signal is received while exercising. If you use the chest strap, the average heart rate will be more accurate than if you occasionally grasp the touch-sensitive handlebar grips.

# Display Console

**CALORIES display:** The estimated cumulative number of calories being burned appears.

**Upper display:** Initially shows the Precor banner. It changes to the program profile when you select a program or press QUICKSTART. A blinking column in the profile indicates your position.

**STRIDE LENGTH display:** A lighted pendulum swings according to your stride length. The pendulum swings to the left as you move your left leg and to the right as you stride forward with your right leg. The icons indicate which muscle groups are affected.

**Center display and the PROGRAMS keypad:** When you press a PROGRAMS key, the program profile appears in the upper display and the program name appears in the center display. During your session, additional information appears in the center display depending on program and user selections.

**Selection keys:** Press the key to move through the information in each column, so you can choose what you want to display during your session. Indicator lights appear next to the item that is displayed.

**QUICKSTART:** Press QUICKSTART to begin your workout immediately.

**HEART RATE display:** If a heart rate is detected, this area displays your heart rate.

**SmartRate display:** A blinking LED lights when you choose a program and enter your age during the setup prompts.

**Number keys:** When you begin a program, you can use the number keys to answer the setup prompts, such as your weight and age. During an exercise session, use the number keys to update information. If the entertainment option is attached, the number keys act as TV channel controls.

**Navigational keys:** These keys let you display or change exercise information and end your session. For more information, refer to Navigational Keypad.

**Lower display:** While you exercise, three sets of numbers show information about your session. For more information, refer to Lower Display Keypad and the Selection Keys.

**RESISTANCE arrow keys:** Use the arrow keys to adjust the resistance.



## More Information about the Upper Display

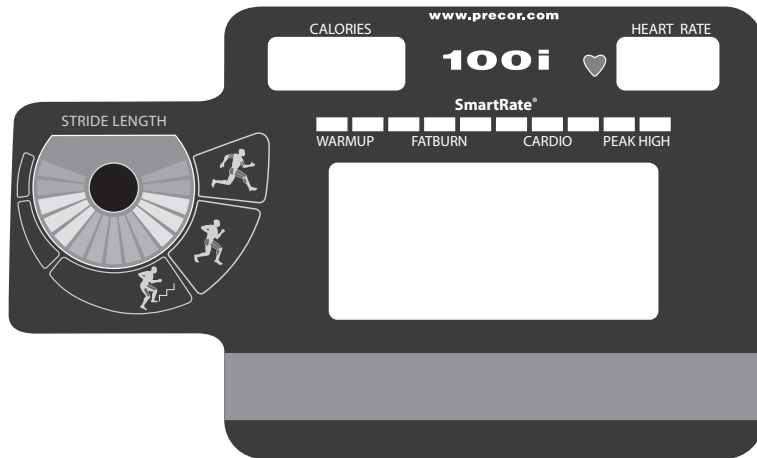

The upper display encompasses the CALORIES, HEART RATE, SmartRate, and a large rectangular program profile display. The following descriptions explain what appears in the displays.

**CALORIES:** The estimated cumulative number of calories burned appears during your exercise session.

**HEART RATE:** Your heart rate appears if you are using the chest strap or touch-sensitive handlebar grips. Refer to *Heart Rate Features*.

**SmartRate:** A blinking segment indicates the zone your heart rate is in when you enter your age after choosing a program and hold on to the touch-sensitive handlebar grips or use a chest strap. Use this display as a visual aid to keep your heart rate in your preferred zone. Refer to *Using SmartRate*.

**Program profile display:** When you choose a program, the profile appears during your exercise session. A blinking segment in the profile indicates your position.

During a workout, the program profile raises or lowers according to which RESISTANCE arrow key is pressed. The column height changes according to the settings shown in Diagram 3. In most programs, the program profile is affected by the RESISTANCE arrow keys with the exception of the Basic HRC Program.

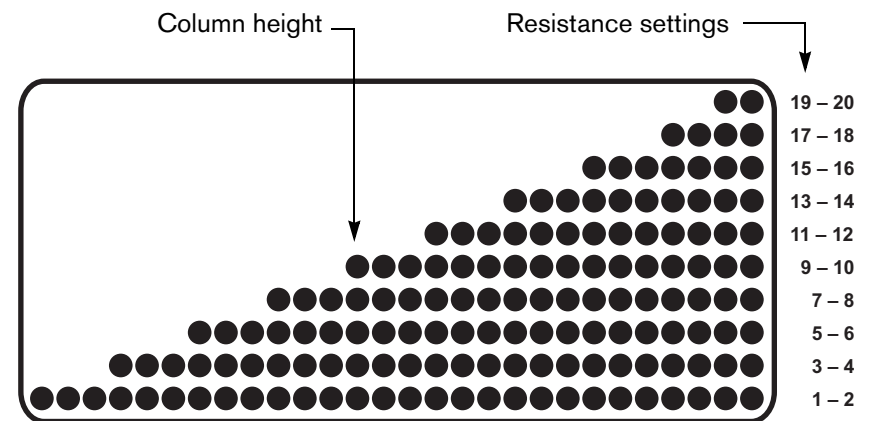

**Diagram 3: Column height in the program profile**

## Stride Length Display

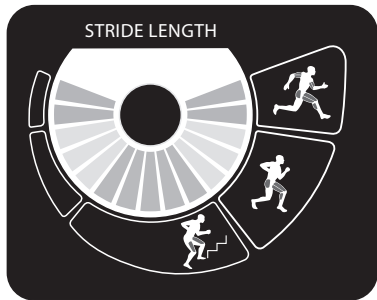

The STRIDE LENGTH display presents a visual representation of the length of your stride. The lighted pendulum swings to the right as you stride forward with your right leg and swings to the left as your left leg moves forward.

The icons indicate which muscle groups are affected by the length of your stride. To view the actual measurement (inches or centimeters) of the length of your stride, choose STRIDE LENGTH through the METRICS key. Refer to *Changing Your Workout Display Options*.

As you lengthen your stride, the lighted pendulum should consistently reach the same level on the right as on the left. This indicates that you are expending the same amount of energy and affecting the same muscle groups with your right leg as with your left.

## More Information about the Center Display

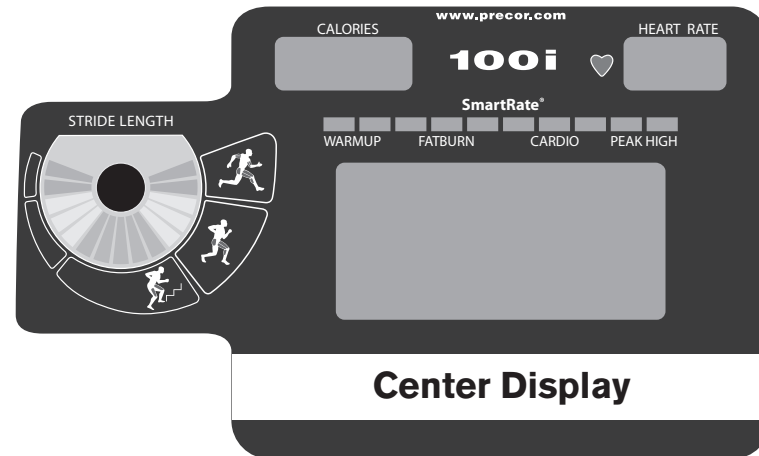

The center display presents the program name when you select a program. During an exercise session, the center display becomes a message bar showing additional information depending on user selections and program interludes. For more information about the selections which may appear in this display, refer to *Exercise Session*.

## More Information about the Lower Display



The lower display provides information about your workout session. You can choose the type of information displayed in Column 1 and Column 3 by pressing the adjacent Selection key. The numbers that appear over each column of information relate to your workout statistics and are described below.

**Note:** If you choose to rest a book or magazine on the display, you can still view these workout statistics.

### Column 1: TIME ELAPSED and TIME REMAINING

**TIME ELAPSED**—displays workout time in minutes and seconds and indicates the amount of time you have been exercising. When you exceed 60 minutes during a single workout, the TIME ELAPSED display converts to hours and minutes.

**Note:** The club can place limits on workout time.

**TIME REMAINING**—shows the amount of time remaining in a workout. If the selected workout time is less than 60 minutes, the display shows time in minutes and seconds. If you select a workout time greater than 60 minutes, the display reflects hours and minutes until the countdown reaches 60 minutes, at which time the display reverts to minutes and seconds.

### Column 2: RESISTANCE

**RESISTANCE**—displays the resistance you feel against your stride. The RESISTANCE arrow keys let you set a resistance level between 1 and 20.

### Column 3: CALORIES/MINUTE, STRIDES/MINUTE DISTANCE

**CAL/MIN**—displays the approximate number of calories burned per minute.

**STRIDES/MIN**—displays the number of strides you complete in a minute up to a maximum value of 510 strides per minute. A stride is an exaggerated walking movement. If you start in a position with one foot plate forward, a stride is completed when you move the rear foot plate all the way forward while the other foot plate moves to the rear. Two strides create one complete revolution of the flywheel. So, the value that appears on the display is always an even number between 56 and 510.

**DISTANCE**—shows linear distance in either miles or kilometers. The distance is calculated based on your calories per minute. The number that appears indicates the distance achieved if the same amount of calories were expended while walking or running.

## Keypads

Use the keypads to enter your workout session selections, to affect what appears on the display, and to establish your stride rate.

Four distinct keypads exist on the display and are discussed in this section:

- Lower Display keypad and the Selection keys
- Navigational keypad in the center of the display
- PROGRAMS keypad
- Number keypad with the ENTER and CLEAR keys

### Lower Display Keypad and the Selection Keys

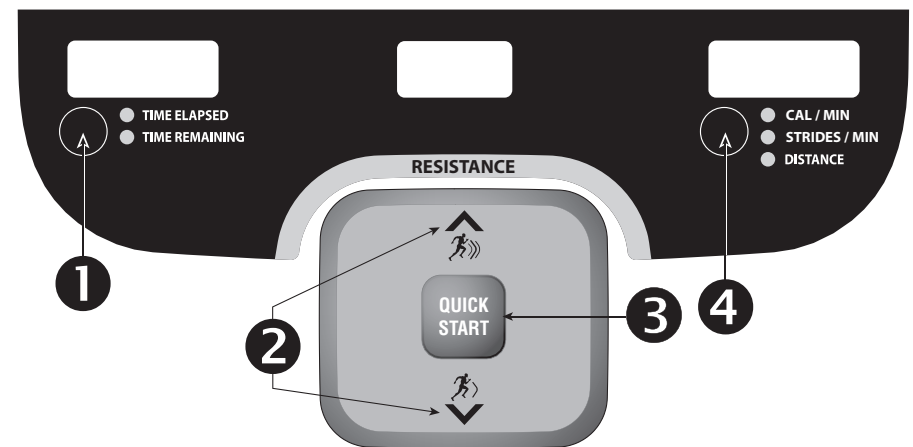
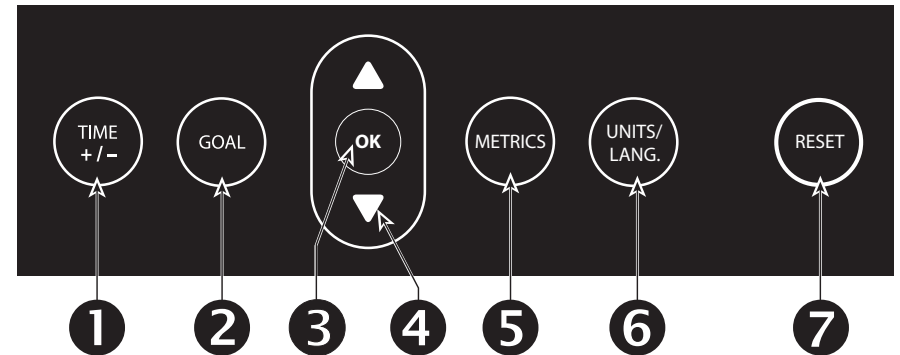

Diagram 4: Lower Display keypad and the Selection keys

- 1 **Left selection key:** Every time you press this key, the display reflects either the amount of time elapsed since you began your exercise session or, it shows the time remaining. An LED lights and indicates which information is being displayed.
- 2 **RESISTANCE:** Press and hold the RESISTANCE arrow keys to increase or decrease the force applied against your stride from 1 to 20.
- 3 **QUICKSTART:** Press QUICKSTART to start your workout immediately using the Manual Program. Refer to *Choosing QUICKSTART*.
- 4 **Right selection key:** Every time you press this key the display reflects either the calories per minute, the strides per minute, or the distance travelled since you began your exercise session. An LED lights and indicates which information is being displayed.

## Navigational Keypad



**Diagram 5: Navigational keypad**

The navigational keypad provides several ways to change your exercise session and to display various workout statistics. The OK key, which allows you to confirm display selections, is also part of the navigational keypad.

- 1 **TIME +/-:** You can change the workout time, while you are exercising, by pressing the TIME +/- key. A blinking number appears in the center display. You can change the number using the navigational arrow keys or enter a different time using the number keys. Refer to *Changing Your Workout Display Options*.
- 2 **GOAL:** Press the GOAL key to change the goal setting from time, distance, or calories when using the Manual, Interval, or Heart Rate Programs. Refer to *Adjusting Program Goals*.  
**Note:** You cannot change the goal during the warm up phase of the Heart Rate Program.

- 3 **OK:** Use the OK key to confirm responses to specific prompts.
- 4 **Up and Down Arrows:** These up and down arrows present the available selections and affect what appears on the display.
- 5 **METRICS:** The METRICS key provides menu selections that let you customize the display with specific workout statistics after you are already engaged in exercising. Refer to *Changing Your Workout Display Options*.
- 6 **UNITS/LANG.:** You can change the units of measure or select one of seven different languages by pressing this key. The display reflects your selections after you press the OK key. For more information, refer to *Changing the Units of Measure or Selecting a Language*.
- 7 **RESET:** Press this key to end the workout session and view your workout summary. An exception to this rule exists if you have entered the 30-second shutdown period. When you press RESET, the display returns to the Precor banner. Refer to *Pausing During a Workout or the Cool-Down Period or Self-Powered Features*.

## PROGRAMS Keypad

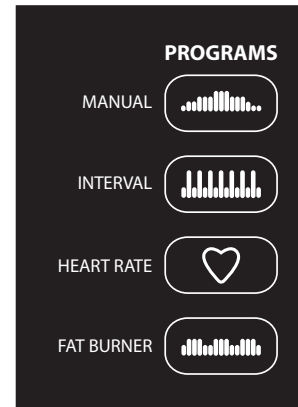

**Diagram 6: PROGRAMS keypad**

The PROGRAMS keypad provides access to all the exercise programs. Press one of the four keys to access a program. Refer to Table 2 below. For a description of each program, refer to *Programs*.

**Note:** Use the OK key to confirm your selection. For more information, refer to *Workout Options*.

**Table 2. Available programs**

<i>PROGRAMS</i> key
MANUAL
INTERVAL
HEART RATE*
FAT BURNER

\* Use of a chest strap or the touch-sensitive handlebar grips is required.



## Number Keypad

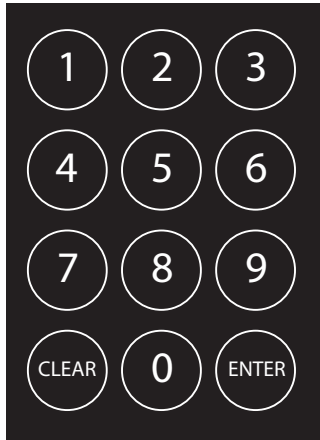

**Diagram 7: Number keypad**

The number keypad has several functions depending on what is connected to the AMT.

<i>Connection</i>	<i>Description</i>
Computer (CSAFE compatible)	If a computer is attached to the CSAFE connection on the AMT, the number keypad lets you enter your user ID and answer other setup prompts.
Entertainment Option	If an entertainment option is connected to the display, the number keypad acts as a remote control which you use to select the available channels. You can also enter number values in answer to exercise session prompts.
Nothing	Whether or not peripheral devices are attached to the unit, the keypad lets you enter number values in answer to exercise session prompts. You need to press ENTER or OK to confirm the selection.

The CLEAR and ENTER keys provide the following functions:

**CLEAR:** Use the CLEAR key to remove the last number being displayed.

**ENTER:** Use the ENTER key to accept the number being displayed.

**Note:** The OK and ENTER keys are usually interchangeable and provide the same function when no peripheral devices are attached to the AMT. However, when answering prompts that originate from a CSAFE device or computer connection, use the ENTER key.

# Workout Options

**CAUTION:** Before beginning any fitness program, see your physician for a complete physical examination. Know your physician-recommended heart rate target zone.

1. Stand on the rear pedestal and face the display.
2. Place one foot in the lower foot plate and grasp an arm or a stationary handlebar for stability while you step into the other foot plate.
3. When you are comfortably situated, begin climbing.

**CAUTION:** Hold on to a handrail to balance yourself.

4. Select one of the following options:

<i>Option...</i>	<i>Steps...</i>
To start exercising immediately	<ul style="list-style-type: none"><li>• Use the QUICKSTART key.</li><li>• Refer to <i>Choosing QUICKSTART</i>.</li></ul>
To select a program	<ul style="list-style-type: none"><li>• Press a PROGRAMS key.</li><li>• Refer to <i>Selecting a Program</i>.</li></ul>
To enter a user ID	<ul style="list-style-type: none"><li>• Use the ENTER key.</li><li>• Refer to <i>Storing Workout Statistics</i>.</li></ul>
To set display preferences in units of measure or language	<ul style="list-style-type: none"><li>• Use the UNITS/LANG. key.</li><li>• Refer to <i>Setting Display Preferences Before Exercising</i>.</li></ul>

## Choosing QUICKSTART

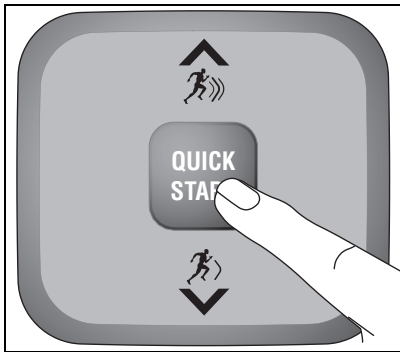

1. While the Precor banner scrolls, press QUICKSTART to begin the Manual Program.

QUICKSTART applies the following defaults:

<b>Prompts</b>	<b>Default Value</b>
Program	Manual
Time	Club setting
Weight	150 lb (68 kg)
Age	0

2. Use the RESISTANCE arrow keys to change the resistance.
3. Maintain a comfortable and consistent stride rate while exercising.

**Note:** To use the SmartRate feature, you need to specify your age. In this case, press the MANUAL key and then press OK. Enter your weight (1–999) and then your age (1–99) when prompted.

## Selecting a Program

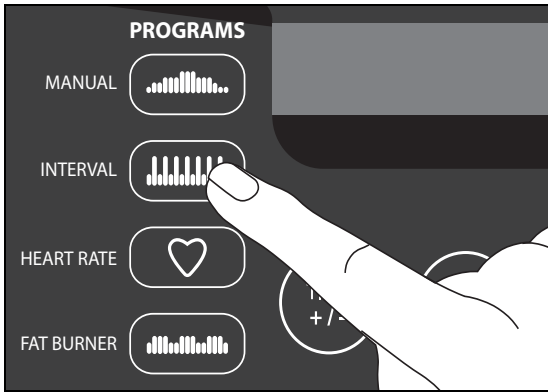

1. While the Precor banner scrolls, press one of the PROGRAMS keys. A portion of the program profile appears in the upper display. The program name appears in the center display.
2. Choose the program you want by pressing OK. For a description of each program, refer to *Programs*.
3. A workout time blinks in the center display. To change the time, use the number keys or navigational arrow keys. Confirm your entry by pressing OK.

The maximum allowable time is 240 minutes. To adjust your workout time while exercising or exercise indefinitely in a program, refer to *Changing the Workout Time*.

**Note:** A workout time prompt does not appear if you select FAT BURNER because the program is preset to 28 minutes.

4. Enter your weight (1 – 999) and then your age (1 – 99) when prompted.

**Note:** To change a value (program, workout time, weight, or age) that you have already entered, press RESET to return to the Precor banner. Select a program and reenter the appropriate values.

## Storing Workout Statistics

Many clubs connect the AMT to a computer so you can easily retrieve your workout statistics and determine how well you are meeting your fitness goals. If you are interested in maintaining workout statistic information, ask the club personnel to create a user account and a user ID for you. A user ID entry is required to store your workout statistics.

**Note:** If the display is blank, you will need to begin moving the foot plates to supply power to the unit. If the Precor banner appears, the AMT is not connected to a computer. Refer to *Selecting a Program* or *Choosing QUICKSTART*.

If the AMT is connected to a computer, the following appears:

CHOOSE QUICKSTART, ENTER, OR A PROGRAM TO BEGIN

To save the workout statistics generated during your exercise session, take the following steps:

1. Press ENTER.
2. Use the number keypad to specify your 5-digit user ID. If you make a mistake, use the CLEAR key and reenter the correct number.
3. When your user ID is shown, press ENTER.  
A message appears and indicates when the user ID is accepted by the computer.
4. To begin your exercise session, select a program. Refer to *Selecting a Program*.  
**Note:** To bypass the user ID entry, press ENTER while all five zeros appear in the user ID field. The workout statistics generated during your exercise session will not be added to your file.

## Setting Display Preferences Before Exercising

While the Precor banner scrolls, you have the opportunity to set units of measure and language display preferences.

Once you set your display preferences, you have a 5-second window to select a program. If you do not select a program from the PROGRAMS menu or press QUICKSTART within the 5-second window, the preferences return to the club settings. If you press the RESET key, the club setting is reinstated.

1. As the Precor banner scrolls, press UNITS/LANG. Continue pressing the key to view the two menu options: UNITS and LANGUAGE.
2. When you are ready, press OK to select the displayed menu option.
3. Use the arrow keys on the navigational keypad to display your preference, and then press OK to select it.
4. Follow the prompts on the display and return to the Precor banner.

**Note:** The changes that you make prior to a workout reset to the club settings whenever the exercise session ends and the display returns to the Precor banner. Changes to your display preferences can also be made during your exercise session. Refer to *Changing Your Workout Display Options*.

<b>Menu Option</b>	<b>Preferences</b>	<b>Effect</b>
UNITS	U.S. or METRIC	Determines which units of measure appear on the display.
LANGUAGE	ENGLISH, DEUTSCH, ESPANOL, FRANCAIS, NEDERLANDS, PORTUGUES, and RUCCKIJJ.	Causes the display messages and prompts to appear in the chosen language.

## Cooling Down After a Workout

Incorporate a cool-down period into your workout to help lower your heart rate and minimize muscle stiffness or soreness.

When you complete a program with a time limit or specified goal, you automatically enter a cool-down period. The resistance is reduced by 20%. To readjust the resistance, press the arrow keys.

**Note:** The program goal or workout time cannot be changed during the cool-down period.

A workout summary appears at the end of the cool-down period. Refer to *Ending a Workout*.

A cool-down period will not be appended to your workout session if the following occurs:

- The club allows the NO LIMIT option for a user's workout time and, you enter a time goal of zero, essentially setting an unlimited workout time.
- The club sets a cool-down time of zero, which eliminates the cool-down phase.
- You exit a program before completing it.

If you specify an unlimited workout time or the club removed the cool-down phase, remember to incorporate a cool-down period at the end of your workout.

## Pausing During a Workout or the Cool-Down Period

If you stop moving the foot plates anytime during a workout or during a cool-down period, the AMT begins a 30-second shutdown. You cannot pause for a longer period of time or change to a different program unless the club has the optional power adapter attached to the unit.

When the optional power adapter is attached, you can pause for a set time, usually two minutes. If you do not resume exercising during that time, the display returns to the banner.

1. To pause, stop moving the foot plates.
2. To resume exercising from pause mode, begin climbing.

**Note:** In pause mode, you have the ability to change your program selection or display options if the optional power adapter is attached. Refer to *Changing Programs in Mid-session* and *Changing Your Workout Display Options*.

## Ending a Workout

**CAUTION:** Hold on to a handrail when you near the end of your exercise session.

1. To view your workout summary, maintain your stride rate above 56 strides per minute when you complete the cool-down period.

The workout summary appears and shows your cumulative workout statistics including warm-up and cool-down periods. You can review your workout statistics as long as you continue to move the foot plates to maintain power.

2. End your workout by pressing the RESET key and return to the Precor banner.
3. Stop moving the foot plates.
4. Hold on to a handrail as you step off the AMT.

**Note:** If the optional power adapter is attached, you do not have to continue moving the foot plates to view your workout statistics. When you complete the cool-down period, the workout summary appears. When you are ready, press RESET to return to the Precor banner.

If you hold onto the touch-sensitive handlebar grips or wear a chest strap while exercising, a heart rate analysis appears during the workout summary. Refer to *Heart Rate Analysis*.



# Programs

This section describes the programs available on the AMT. Use this section as a reference tool to better understand each program's purpose.

## Choosing a Program

Choosing a program depends on your goals. If you are a beginner or returning to regular exercise, you can start a cardio-conditioning program to slowly return your body to a comfortable level of exercise. If you have been exercising and feel that you have an intermediate or advanced fitness level, you probably have established goals. The Precor web site ([www.precor.com](http://www.precor.com)) can give you many ideas about fitness routines and advice from the experts.

Most of the exercise choices on the AMT are preprogrammed with the option to override the suggested levels by using the RESISTANCE arrow keys. An exception to this rule is the Heart Rate Program.

If your level of exertion becomes too great, reduce your stride rate or adjust the resistance level by using the RESISTANCE arrow keys to override each upcoming segment in the program profile. If you use the arrow keys, the profile changes accordingly.

## Program Tips

- While exercising, you need to move the foot plates constantly. Stopping any movement causes the AMT to shut down to conserve battery power. START CLIMBING appears on the display and the AMT displays a 30-second countdown before it shuts off. If you move the foot plates during the countdown period, you can resume exercising where you left off.
- Begin at the Precor banner and choose a program by pressing a PROGRAMS key or QUICKSTART. Refer to *Workout Options*.
- A blinking column indicates your position as you progress through a program.
- Prior to choosing a program, you may press the UNITS/LANG. key to access units of measure or language settings. After pressing OK to confirm new settings, you must select a program within five seconds for the changes to become effective. Refer to *Setting Display Preferences Before Exercising*.
- To use the SmartRate feature, you need to specify your age and wear a chest strap or hold on to the touch-sensitive handlebar grips. For more information, refer to *Changing Your Workout Display Options*.
- The club can set limits on workout, pause, and cool-down times. Check with your club or facility manager to learn if any club limits are in place that might affect your program selections.

## Manual Program



The Manual Program profile, available by pressing the MANUAL key, begins as a flat line. You control resistance settings using the RESISTANCE arrow keys. The program profile reflects any changes. The blinking column indicates your position in the program.

The workout time reflects the club setting. A cool-down period occurs automatically when you end your workout.

**Note:** An exception to the cool-down period exists if the club allows it. Refer to *Cooling Down After a Workout* for more information.

To change the workout time, press the TIME +/- key. Refer to *Changing the Workout Time*. To change to a distance or calorie goal, press the GOAL key. Refer to *Changing Your Workout Display Options*.

## Interval Program



The Interval Program, available by pressing the INTERVAL key, is among the best for conditioning your cardiovascular system. The program raises and lowers your level of exertion repeatedly for the specified period of time.

The program lets you choose the rest and work intervals according to your training regimen.

While exercising, you can vary your stride rate and the resistance. To change the preset resistance settings, use the RESISTANCE arrow keys. The settings are repeated throughout the remainder of the program. The display lets you know when the resistance is about to change, and indicates the levels of the next interval.

The initial settings for resistance are:

Rest interval resistance:	1
Work interval resistance:	4

If you prefer to set a calorie or distance goal, use the GOAL key. Refer to *Changing Your Workout Display Options*.

## Basic HRC Program



The Basic Heart Rate Control Program lets you set a target for your heart rate. The program adjusts the resistance to maintain your heart rate within two beats per minute of the target heart rate while you exercise. To use this program, you must enter your age and wear a chest strap so your heart rate can be monitored throughout the session.

**Important:** Consult your physician to determine the appropriate target heart rate for your age and fitness level. If your physician recommends a different target heart rate than the one that appears on the display, use the navigational arrow keys to change the target heart rate once you finish the warm-up period. Do not exercise over the recommended range.

## Basic HRC Program Tips

The Basic HRC Program enhances your overall cardiovascular fitness levels to help you achieve your weight loss and fitness goals. Read through the following tips before selecting the Basic HRC Program. These tips provide general information regarding how the program functions. For more information and exercise suggestions, refer to the Precor web site at [www.precor.com](http://www.precor.com).

**Important:** Maintain a consistent stride rate above 56 strides per minute. Automatic adjustments to the resistance cannot take place if you drop below the minimum power requirements.

- The program provides a 3-minute warm-up period. During this time, you may change the resistance, but you cannot change the goal setting.  
**Note:** When your target heart rate is achieved or the 3-minute period elapses, the warm-up period ends and the program begins at which point, you may change to a distance or calorie goal.
- The program automatically adjusts the resistance to keep your heart rate at the selected target. After the warm-up period, pressing the RESISTANCE arrow keys no longer affects the resistance levels. Check the SmartRate display to see if you are maintaining your preferred zone. Check the HEART RATE display to determine your actual heart rate. For information about understanding your target heart rate, refer to *Heart Rate Features*.

- You can change the target heart rate, but doing so affects the unit's ability to maintain your target heart rate in the preferred zone. It takes time for the AMT to readjust the resistance so that your heart rate remains on target.
- The workout time is set to the club limit. To adjust the time, press the TIME +/- key and use the navigational arrow keys followed by OK to change the workout time.
- A cool down period is automatically added to the end of the program.

If you are having difficulty with the heart rate features, talk to your club or facility manager.

## Fat Burner Program



The Fat Burner Program, available by pressing the FAT BURNER key, is a fairly intense 28-minute program designed to burn fat and increase your cardiovascular conditioning. Review the program profile on the display to determine the ascent and descent levels of the program.

Anytime during a workout, you can override the settings by pressing the RESISTANCE arrow keys. The changes raise or lower the columns on the remaining portion of the program profile.

# Exercise Session

This section describes how to access the following attributes through the use of the navigational keypad. Any display selections set during the course of your exercise session are reset to the club settings when you end your session.

While exercising, you can:

- change the program you are using
- change the workout time
- choose between time-, distance-, or calorie-type goals
- display more workout statistics
- choose between U.S. standard and Metric units of measure
- display messages and prompts in a different language

**Note:** Prior to selecting a program, you can select preferences for language and units of measure. Refer to *Setting Display Preferences Before Exercising*.

When you enter a navigational key menu such as UNITS/LANG. or TIME +/-, you have 30 seconds to make your selection. If no selection is made during those 30 seconds, the display automatically returns to the program session.

**Important:** Do not press the RESET key, during those 30 seconds, in an attempt to return to your program because you will inadvertently exit your program. A the workout summary appears when you exit the program.

## Changing Programs in Mid-session

You can change programs in the middle of a session by selecting a new program from the PROGRAMS key menu. All accumulated workout statistics are transferred to the new program as you continue exercising.

**Note:** You cannot select a different program if you stop moving the foot plates and the AMT begins its 30-second shutdown. Refer to *Pausing During a Workout or the Cool-Down Period*.

Certain programs are not available for mid-session transfers due to set goals and program preferences. If this occurs, a message scrolls across the center display.

## Changing the Workout Time

To change the duration of your program, take the following steps:

1. Press TIME +/-.
2. A workout time blinks in the center display. Use the navigational arrow keys or the number keys to adjust the time.
3. Press OK.

A message scrolls across the display indicating that the new workout time has been accepted. If you choose this option, the automatic cool-down period is eliminated. You will need to incorporate a cool-down period when you end the program.

The club can limit the duration of exercise sessions and certain programs have fixed time goals which do not allow adjustments. If your attempt to change the workout time is not accepted, display messages scroll and indicate the reasons.

## Adjusting Program Goals

To designate a distance, calories, or time goal while exercising take the following steps:

1. Press GOAL. Continue pressing the key to scroll through the available options: TIME, DISTANCE or CALORIES.
2. When you are ready, press OK to select the displayed goal.

<i>Selection</i>	<i>Description</i>
TIME	<ul style="list-style-type: none"><li>• A time-based goal is the setting for all programs. If you want to exercise for a set time, select this goal.</li></ul>
DISTANCE	<ul style="list-style-type: none"><li>• A distance-based goal lets you select a set distance between 1 and 50 miles or kilometers (km).</li></ul>
CALORIES	<ul style="list-style-type: none"><li>• A calories-based goal lets you exercise until you reach a set calorie amount between 1 and 1000.</li></ul>

3. A blinking number appears indicating that the system is ready for adjustments to the goal. Use the number keys or navigational arrow keys to change the setting.
4. When you are ready, press OK. If the program you are using allows changes to goal settings, a prompt scrolls across the display indicating that your selection has been accepted. The TIME REMAINING display changes according to the goal being set.

## Changing Your Workout Display Options

During an exercise session, the center display becomes a message bar. It can show additional workout statistics depending on user selections accessed through the METRICS menu.

To display more workout statistics or choose one among them, take the following steps:

1. Press METRICS.
2. Scroll through all the available workout statistic displays by continually pressing the METRICS key. Refer to Table 3.
3. When you are ready, press OK to select a displayed metric or display the entire menu consecutively, by selecting SHOW ALL.

**Note:** To remove a scrolling statistic from the message bar, you need to reenter the METRICS menu and select a different workout statistic display or select the OFF option.

**Table 3. Workout statistics available in the OPTIONS menu**

<i>OPTIONS Menu</i>	<i>Description</i>
% COMPLETE	Shows how much of the program goal you have completed.
TIME IN ZONE	Displays the total time that your heart rate is within the range of 55% to 84% of your target heart rate.
SEGMENT TIME REMAINING	Indicates the amount of time, in minutes and seconds, that remain in the highlighted column of the profile before the next column begins blinking.
AVERAGE SPEED	Displays the average miles or kilometers per hour. The number that appears is determined by dividing the total strides by the elapsed time.
CALS/MIN	Displays the approximate number of calories burned per minute.
CALS/HR	Displays the approximate number of calories burned per hour.
WATTS	Shows your current energy expenditure level.
METS	Shows the metabolic units associated with your current energy expenditure level, derived from the calories per minute value and adjusted for your weight.

<i>OPTIONS Menu</i>	<i>Description</i>
TARGET HR	Shows the current target heart rate setting.
AVG HEART RATE	Displays your average heart rate. The number is based on systematic sampling taken while you are exercising. A chest strap will give you a more accurate heart rate average than if you occasionally use the touch-sensitive handlebar grips. If no heart rate reading occurred during your exercise session, 0 BPM or three dashes appear when you change to this display.
STRIDE LENGTH	Shows the current length of your stride in inches or centimeters.
SHOW ALL	Presents all the workout statistics in this menu in consecutive order.
OFF	Stops scrolling the workout statistics, found in this table, across the message bar.

## Changing the Units of Measure

Display measurements can appear in either Metric or U.S. Standard. To change this setting, perform the following steps:

1. Press UNITS/LANG. The word UNITS appears on the display.
2. Press OK. UNITS is replaced by the one of two options: U.S. or METRIC.
3. Toggle between the two options by pressing the ▼ key on the navigational keypad.
4. When you are ready, press OK to select the displayed unit of measure. A message scrolls across the display indicating that the unit of measure has changed.



## Selecting a Language

You can choose to display text messages in seven different languages. To select a different language before or during an exercise session, take the following steps:

5. Press UNITS/LANG. Press the key a second time and LANGUAGE appears and scrolls across the display.

**Note:** When you press the UNITS/LANG. key a third time, you exit the menu and return to the Precor banner. The center display appears blank. To reenter the menu, press UNITS/LANG. again.

6. While LANGUAGE scrolls across the display, press OK to select it.
7. Continually scroll through the available language options by pressing the ▼ key on the navigational keypad.  
ENGLISH, DEUTSCH, ESPANOL, FRANCAIS, NEDERLANDS, PORTUGUES, and RUCCKIJJ.
8. When you are ready, press OK to select the displayed language. A message scrolls across the display indicating that the language has been changed.

*Notes:*



## C100i Commercial Adaptive Motion Trainer

### Product Specifications

Length	74 in (199 cm)
Width	28 in (72 cm)
Height	69 in (176 cm)
Weight	445 lb (202 kg)
Shipping weight	520 lb (236 kg)
Power	Self-powered
Frame	Powder-coated steel
Regulatory Approvals	FCC, ETL, CE, EN957

### Product Features

CSAFE Compatible
Entertainment Option Available
Heart Rate Telemetry
QuickStart™
SmartRate®
Touch Heart Rate

### Programs

<b>Manual</b>
<b>Interval</b>
<b>Heart Rate</b>
Basic HRC*
<b>Fat Burner</b>

### Electronic Readouts

% Complete	Resistance
Average Heart Rate*	Segment Time Remaining
Average Speed	SmartRate*
Calories	Stride Length
Calories Per Minute	Strides Per Minute
Calories Per Hour	Target Heart Rate
Distance	Time
Heart Rate*	Time Elapsed
Heart Rate Analysis*	Time in Zone*
Language	Time Remaining
Maximum Heart Rate*	Units
METS	Watts
Profile	Workout Summary

\* Use of a chest strap or the touch-sensitive handlebar grips is required.

Precor, C, CrossRamp, EFX, M, Move Beyond, and SmartRate are registered trademarks of Precor Incorporated. AMT, Adaptive Motion Trainer, Crosstrainer, QuickStart, and StretchTrainer are trademarks of Precor Incorporated. Copyright 2007 Precor Incorporated. Specifications subject to change without notice. [www.precor.com](http://www.precor.com)

#### NOTICE:

Precor is widely recognized for its innovative, award winning designs of exercise equipment. Precor aggressively seeks U.S. and foreign patents for both the mechanical construction and the visual aspects of its product design. Any party contemplating the use of Precor's product designs is hereby forewarned that Precor considers the unauthorized appropriation of its proprietary rights to be a very serious matter. Precor will vigorously pursue all unauthorized appropriation of its proprietary rights.

**PRECOR**<sup>USA</sup>  
move beyond®

Precor Incorporated  
20031 142nd Ave NE  
P.O. Box 7202  
Woodinville, WA USA 98072-4002



C100i URM 49737-102, en  
30 April 2007

## Free Manuals Download Website

<http://myh66.com>

<http://usermanuals.us>

<http://www.somanuals.com>

<http://www.4manuals.cc>

<http://www.manual-lib.com>

<http://www.404manual.com>

<http://www.luxmanual.com>

<http://aubethermostatmanual.com>

Golf course search by state

<http://golfingnear.com>

Email search by domain

<http://emailbydomain.com>

Auto manuals search

<http://auto.somanuals.com>

TV manuals search

<http://tv.somanuals.com>