

Owner's Manual

M9.33i

M9.35i

Low-Impact Treadmills



PRECOR^{USA}
move beyond[®]

Important Safety Instructions

When using an electrical appliance, always take basic precautions, including the following:

- Read all instructions before using the treadmill. These instructions are written for your safety and to protect the unit.
- Before beginning any fitness program, see your physician for a complete physical examination.

Il est conseillé de subir un examen médical complet avant d'entreprendre tout programme d'exercice. Si vous avez des étourdissements ou des faiblesses, arrêtez les exercices immédiatement.

DANGER

To reduce the risk of electrical shock always unplug the treadmill from the electrical outlet immediately after using and before cleaning.

WARNING

To reduce the risk of burns, fire, electric shock, or injury, take the following precautions:

- Do not allow children or those unfamiliar with its operation on or near the treadmill. Do not leave children unsupervised around the unit.

- Never leave the treadmill unattended when it is plugged in. Unplug the treadmill from the power source when it is not in use, before cleaning it, and before putting on or taking off parts.
- Assemble and operate the treadmill on a solid, level surface. Locate the treadmill a few feet from walls or furniture. Keep the area behind the treadmill clear.
- Maintain the treadmill in good working condition. Refer to the *Maintenance* section. Make sure that all fasteners are secure and the belt is clean and running smoothly.
- Use the treadmill only for its intended purpose as described in this manual. Do not use accessory attachments that are not recommended by the manufacturer, as such attachments may cause injuries.
- Never operate the unit if it is damaged, not working properly, when it has been dropped, or has been dropped in water. Return the treadmill to a service center for examination and repair.
- Keep the power cord and plug away from heated surfaces.
- Do not operate the treadmill where aerosol (spray) products are being used or where oxygen is being administered.

- Do not use outdoors.
- Never block the air vents while operating the treadmill. Keep the air vents clean and free of lint, hair, or anything that might impede the free flow of air.
- Do not attempt to service the treadmill yourself except to follow the maintenance instructions found in this manual.
- Never drop or insert objects into any opening. Keep hands away from moving parts.
- Keep all electrical components, such as the power cord and I/O switch, away from liquids to prevent shock. Do not set anything on the handrails, display console, or hood. Place liquids, magazines, and books in the appropriate receptacles.

DANGER **The treadmill must be connected to a dedicated, grounded circuit. See *Grounding Instructions*.**

- Wear proper exercise clothing and shoes for your workout and avoid loose clothing. Do not wear shoes with heels or leather soles. Check the soles of your shoes and remove any dirt and embedded stones. Tie long hair back.
- Use care when getting on or off the treadmill. Always grasp the handrail when stepping on the running belt and keep the initial speed at or below 1 mile per hour (mph) or 1 kilometer per hour (kph). Never step off the treadmill while the running belt is moving.
- Before the running belt begins moving (before your workout), and after it stops (at the end of your workout), straddle the belt by placing your feet firmly on the right and left staging platforms.
- Keep your body and head facing forward. Never attempt to turn around on the treadmill.
- The safety clip must be attached at waist level before your workout. A lanyard connects the safety clip to the red STOP button on the display console. If you encounter difficulties, a strong tug on the lanyard stops the running belt.
- Do not rock the unit. Do not stand on the handrail(s), display console, or hood.
- Do not overexert yourself or work to exhaustion. If you feel any pain or abnormal symptoms, stop your workout immediately and consult your physician.
- When the treadmill is not in use, disconnect the unit by turning the power switch to the OFF (O) position, and then remove the power plug from the wall outlet.

Password Security

To help prevent unauthorized use, the treadmill is equipped with password protection. The password involves entering three keys in sequence. If the correct keys are not pressed within two minutes, further access is denied and the running belt will not move. For more information, refer to *Entering the Password*.

Safety Approval

When identified with the ETL-c logo, the unit has been tested and conforms to the requirements of CAN/CSA-E-335-1/3-94, *Safety of Household and Similar Electrical Appliances*.

Grounding Instructions

The treadmill must be grounded. If the unit malfunctions or breaks down, grounding provides a path of least resistance for electric current, which reduces the risk of electrical shock. The unit is equipped with a power cord having an equipment-grounding conductor and a grounding plug. The plug must be inserted into an outlet that is properly installed and grounded in accordance with all local codes and ordinances. Failure to properly ground the treadmill could void the Precor Limited Warranty.

DANGER

Improper connection of the equipment-grounding conductor can result in a risk of electric shock. Check with a qualified electrician or service person if you are in doubt as to whether the unit is properly grounded. Do not modify the plug provided with the treadmill. If it does not fit the outlet, get a proper outlet installed by a qualified electrician.

120 V Units Designated for U.S. Markets

The treadmill must be connected to a dedicated, grounded circuit with a nominal 120-volt rating. The unit's grounding plug looks like the plug shown in Diagram 1. The power outlet must have the same configuration as the plug. No adapter should be used with this product.

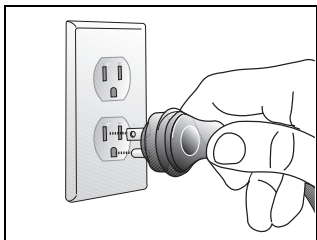

Diagram 1: Power plug

Radio Frequency Interference (RFI)

Federal Communications Commission, Part 15

The treadmill has been tested and found to comply with

- the IEC EMC Directive (international electromagnetic compatibility certification)
- the limits for a Class B digital device, pursuant to Part 15 of the FCC Rules. These limits are designed to provide reasonable protection against harmful interference in a residential installation. The treadmill generates, uses, and can radiate radio frequency energy and, if not installed and used in accordance with the owner's manual instructions, may cause harmful interference to radio communications.

If the treadmill does cause harmful interference to radio or television reception, which can be determined by turning the unit OFF and ON, you are encouraged to try to correct the interference using one or more of the following measures:

- Reorient or relocate the receiving antenna for your TV, radio, VCR, etc.
- Increase separation between the unit and the receiver (TV, radio, etc.).

- Connect the treadmill into a different power outlet on a dedicated circuit different from the one used by the receiver (TV, radio, etc.). No other appliance should be plugged into the same power outlet as the treadmill
- Consult an experienced radio/TV technician for help.

WARNING Per FCC rules, changes or modifications not expressly approved by Precor could void the user's authority to operate the equipment.

Canadian Department of Communications

This digital apparatus does not exceed the Class B limits for radio noise emissions from digital apparatus set out in the Radio Interference Regulations of the Canadian Department of Communications.

Le présent appareil numérique n'émet pas de bruits radioélectriques dépassant les limites applicables aux appareils numériques de la class B prescrites dans le Règlement sur le brouillage radioélectrique édicté par le ministère des Communications du Canada.

ATTENTION: Haute Tension

Débranchez avant de réparer

Owner's Manual: Important Safety Instructions

European Applications

This product conforms to the requirements of the European Council Directive 89/336/EEC, *Electromagnetic Compatibility* and has been tested to the following standards:

- **EN55022**, Limits & Methods of Measurement of Radio Interference, Information Technology Equipment.
- **EN50082-1**, Generic Immunity Standard for Residential, Commercial and Light Industrial Products.

This product additionally conforms to the requirements of the European Council Directive 73/23/EEC, Low Voltage Directive and has been tested to the following standard:

- **IEC 335-1**, Safety of Household and Similar Electrical Appliances.

Obtaining Service

You should not attempt to service the treadmill except for maintenance tasks as described in this manual. The treadmill does not contain any user-serviceable parts. For information about product operation or service, see the Precor website at www.precor.com.

Should you need more information regarding customer support numbers or a list of Precor authorized service centers, visit the Precor website at www.precor.com/contact.

For future reference, write the model, serial number, and date of purchase for your unit in the space provided. The serial number is printed on a label located on the front panel, near the power cord (Diagram 2).

Model #: _____ Serial #: _____

Date purchased: _____

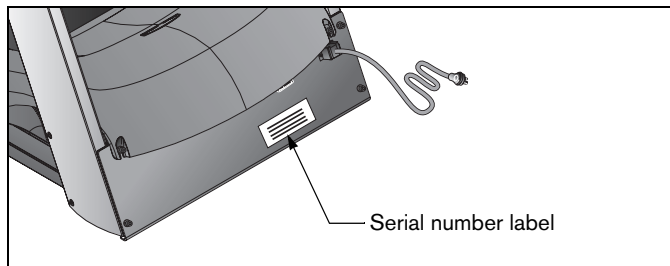

Diagram 2: Location of serial number

Table of Contents

Important Safety Instructions 1

Password Security	3
Safety Approval	3
Grounding Instructions	3
Radio Frequency Interference (RFI)	4
European Applications	5
Obtaining Service	6

Treadmill Safety Features 9

Using the Safety Clip	9
Entering the Password	10
Using the Handrails	10
Turning the Unit ON and OFF	10

Heart Rate Features 11

Guidelines	11
Using the Heart Rate	
Touch-Sensitive Grips	13
Using SmartRate	14
Exercise to Your Target Heart Rate	15
Heart Rate Analysis	16

Display Console 17

More Information about the Lower Display	19
Keypad	21

Workout Options 25

Choosing QUICKSTART	26
Selecting a User ID	27
Selecting a Program	29
Cooling Down After a Workout	30
Pausing During a Workout or the	
Cool-Down Period	31
Ending a Workout	32

Programs 33

Choosing a Program	34
Program Tips	34
5K Program	35
10K Program	35
Calories Goal Program	36
Custom Programs	36
Distance Goal Program	38
Fitness Test Program	38
Heart Rate Program	41

HR Programs	42
Interval Programs	44
Manual Program	45
One Mile Program	45
Random Program	46
Run Programs	46
Track Program	47
Two Mile Program	47
Walk in the Park Program	48
Walk Programs	48
Weight Loss Program	49

Advanced Programming and Troubleshooting 50

Advanced Programming Tips	50
Clearing User ID Preferences	51
Changing a User ID to a Name (M9.35i)	51
Selecting a U.S. Standard or Metric Display	52
Selecting Password Protection	53
Informational Displays	54
Troubleshooting Error Codes	57
Troubleshooting Heart Rate	58

Maintenance	59
Inspection	59
Cleaning the Equipment	59
Storing the Chest Strap	60
Checking the Alignment of the	
Running Belt	60
Adjusting the Running Belt	61
Servicing the Treadmill	62
Long-Term Storage	62
Precor Residential Equipment	
Limited Warranty.....	63

Treadmill Safety Features

The treadmill is equipped with certain items that, when used properly, help sustain an enjoyable workout. These items include:

- Safety clip
- Password protection
- Handrail
- I/O power switch

Important: Before exercising, review the Important Safety Instructions found at the beginning of this manual.

Using the Safety Clip

Attach the safety clip to your clothing before each workout. A tug on the lanyard trips the safety switch inside the display console and stops the running belt.

If the safety switch trips while you are exercising, reattach the safety clip to your clothing, enter the password, and press SPEED ▲.

Note: The treadmill retains your workout statistics if you resume your workout within ten minutes.

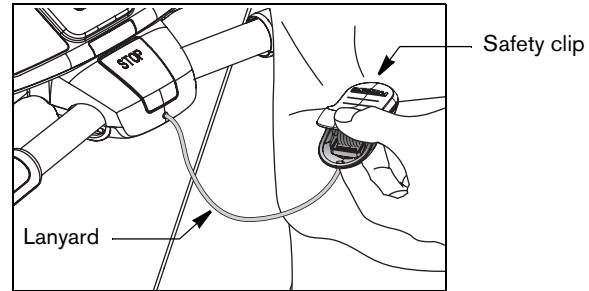

Diagram 3: Attach the safety clip to your clothing

Entering the Password

The treadmill provides password protection to help prevent unauthorized use. At the password prompt, press the following key sequence: INCLINE ▼, SPEED ▼, SPEED ▲.

An asterisk appears on the display with each key press. If the correct keys are not pressed within two minutes, the Precor banner appears on the display and the running belt does not move.

Important: Do not assume the treadmill is safe because of password protection. Never leave children unsupervised around the treadmill.

Using the Handrails

To maintain your balance, always grasp a handrail when you step on or off the treadmill, and when you use the keypad.

To learn more about the touch-sensitive handrail grips, refer to *Heart Rate Features*.

Turning the Unit ON and OFF

To turn the unit ON and OFF, use the I/O power switch located at the front of the unit, near the power cord. Refer to Diagram 4.

Important: When it is not being used, turn the unit OFF.

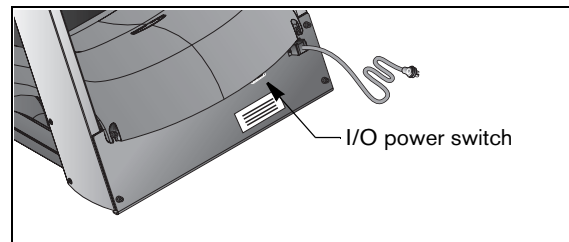
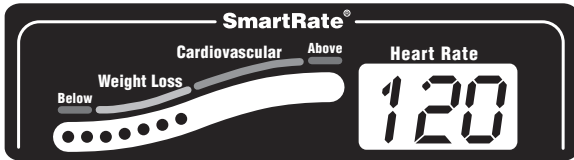

Diagram 4: I/O power switch

Heart Rate Features



Heart rate and SmartRate® features are available when you wear the chest strap or grasp both touch-sensitive handrail grips. When a heartbeat is detected, the Heart Rate display shows your heart rate and the SmartRate LED pulses and indicates your target zone.

Guidelines

Read the following before using the heart rate feature.

- Consult your physician before engaging in any vigorous exercise. Do not use the heart rate features until authorized by your physician.
- Know your heart rate and your physician- recommended heart rate target zone. Individual heart rates vary according to several physiological factors and may not correspond directly with Diagram 5.

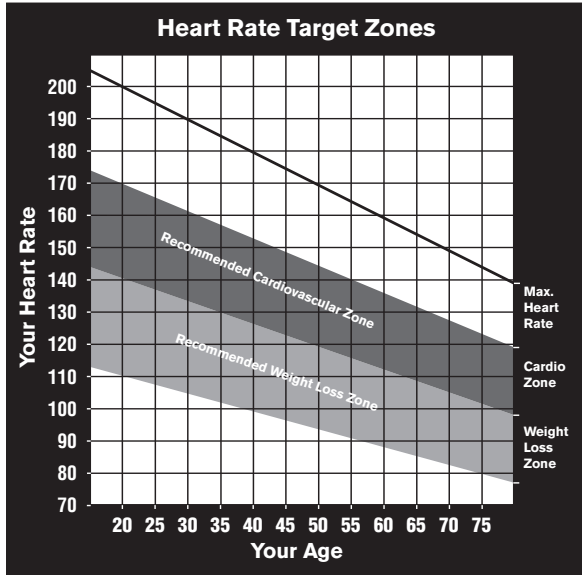

Diagram 5: Heart rate target zones

- The calculation used for the heart rate target zone is:
 Low range: $(220 \text{ minus your age}) \text{ multiplied by } 55\%$
 High range: $(220 \text{ minus your age}) \text{ multiplied by } 85\%$

- After you put on the chest strap, face the display console for a minimum of 15 seconds. This allows the receiver in the console to recognize the signal from the chest strap.
- If you prefer to use the hand-held heart rate feature, grasp both touch-sensitive handrail grips and wait five to ten seconds. Your heart rate appears in the Heart Rate display.
- If three dashes (---) appear on the display, the treadmill cannot detect a heart rate. Make sure the chest strap is positioned properly around your chest and against your skin. If you are using the touch-sensitive handrail grips, make sure your hands are moist (not dry) and you use both hands.
- Always face forward on the treadmill and use the handrail for balance. Keep upper body movement to a minimum.

Using the Heart Rate Touch-Sensitive Grips

While exercising, you must grasp both touch-sensitive handrail grips for a minimum of five to ten seconds to transmit your heart rate to the display. Refer to Diagram 6.

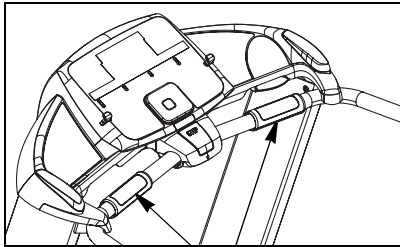

Touch-sensitive handrail grips

Diagram 6: Touch-sensitive handrail grips

Usually, the concentration of salts in a person's perspiration provides enough conductivity to transmit a signal to the receiver inside the display console. However, some people, because of body chemistry or erratic heart beats cannot use the hand-held heart rate feature on the treadmill. A chest strap may provide better results.

Important: While exercising, do not grasp the touch-sensitive handrail grips and wear the chest strap at the same time. The touch-sensitive handrail grips override the signals from the chest strap transmitter. If used together, inconsistent reading may occur.

Using SmartRate

The SmartRate feature helps you monitor and maintain your heart rate in the target zone best suited to your specific needs. All 15 LEDs may light during a workout. When the treadmill detects a heart rate, a single LED blinks and indicates the zone that your heart rate is in, either weight loss or cardiovascular.

The 15 LEDs in the SmartRate display are color-coded. A pulsating red LED indicates you are outside the recommended heart rate target zone. Yellow LEDs indicate when you are exercising within the weight loss zone. Green LEDs indicate when you are exercising within the cardiovascular zone.

Refer to Table 1 to see the relationship between the pulsating LED and your target heart rate.

The SmartRate indicator lights do not appear when:

- You press QUICKSTART at the banner.
- You bypass the AGE prompt.
- You do not wear or improperly position the chest strap.
- You fail to grasp both touch-sensitive handrail grips for five to ten seconds.

Note: Review the information on the QUICKSTART card that accompanies your literature packet. It explains how to adjust the chest strap.

Table 1. Heart rate target zones and SmartRate LEDs

<i>Heart Rate Zone Percent</i>	<i>LED Lit</i>	<i>LED Blinking</i>
Below 50	First	Red
50 to 54	Second	Red
55 to 57	Third	Yellow
58 to 60	Fourth	Yellow
61 to 63	Fifth	Yellow
64 to 66	Sixth	Yellow
67 to 69	Seventh	Yellow
70 to 71	Eight	Green
72 to 74	Ninth	Green
75 to 76	Tenth	Green
77 to 79	Eleventh	Green
80 to 81	Twelfth	Green
82 to 84	Thirteenth	Green
85 to 87	Fourteenth	Red
Above 87	Fifteenth	Red

CAUTION: Your heart rate should never exceed 85% of your maximum aerobic heart rate. If it does, immediately reduce your speed or, if possible, adjust the incline to return your heart rate to your physician-recommended target zone.

Exercise to Your Target Heart Rate

The treadmill includes heart rate programs that let you exercise based on a specified heart rate or target zone. As you exercise, the heart rate programs monitor your heart rate and automatically maintain it within a few beats per minute (bpm) of the selected target or zone. Refer to Table 2. Your actual heart rate appears in the Heart Rate display.

You must wear the chest strap so the programs can monitor your heart rate throughout the workout. For more information, refer to *Programs*.

Table 2. Heart rate programs adjust the incline or speed by monitoring your heart rate

<i>Program</i>	<i>M9.33i</i>	<i>M9.35i</i>
Heart Rate	✓	✓
HR Weight Loss	✓	✓
HR Heart Health		✓
HR Endurance		✓
HR Speed		✓
Fitness Test		✓

Heart Rate Analysis

Every time you complete a program using the chest strap or touch-sensitive grips, the treadmill provides a heart rate analysis after the workout summary.

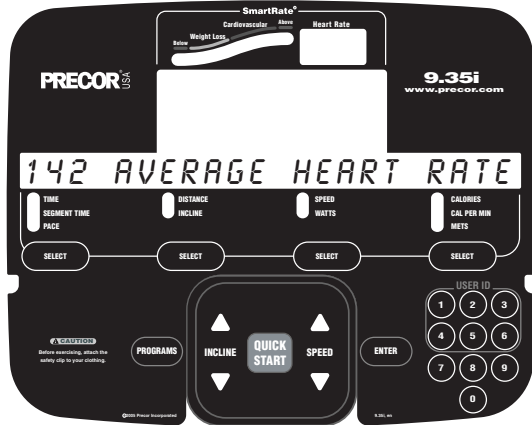

Your average heart rate appears followed by the maximum heart rate achieved during your workout. A third display, indicates the amount of time your heart rate remained between the target zones shown. The heart rate analysis is based on how often your heart rate signal is received while exercising. If you use the chest strap, the average heart rate will be more accurate than if you occasionally grasp the touch sensitive grips.

Note: The Fitness Test does not provide a heart rate analysis display. It is replaced by a fitness score. Refer to *Fitness Test Program*.

Display Console

Center display: Initially shows the Precor banner. It changes to the program profile. A blinking column in the profile indicates your position. The height of the column indicates the incline level.

SmartRate display: LEDs light in this column when the SmartRate feature is activated. Follow the LEDs to monitor your heart rate and maintain it in your target zone.

Heart Rate display: If a heart rate is detected, this area displays your heart rate.

Lower display: Four sets of numbers show information about your session. Use the SELECT keys to choose what information to display.

LEDs: Light and clarify what workout statistics appear on the display.

SELECT keys: Each key lets you move through the information in each column, choosing what you want to display during your session.

Keypad: Use the keypad to:

- Select a program
- Answer prompts prior to starting a program
- Adjust the incline or speed

For more information, refer to Keypad.

User 1–6: Press a user ID (1–6) at the Precor banner to personalize your workout session. Key workout information is stored between sessions.

QUICKSTART: Press QUICKSTART to begin your workout immediately. It lets you bypass the setup prompts.

Red STOP button: Press to pause a workout or return to the banner.

Number keys: During a workout, use the number keys to quickly change the speed or incline, then press the corresponding INCLINE or SPEED keys to initiate the change. When you begin a program, you can use these keys to specify new information.

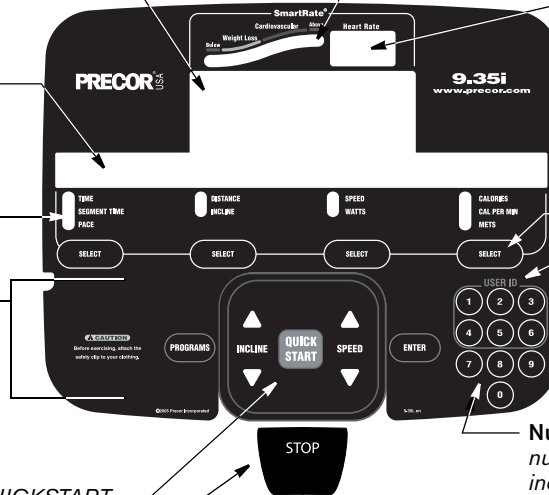

Center display: Initially shows the Precor banner. It changes to the program profile. A blinking column in the profile indicates your position. The height of the column indicates the incline level.

Lower display: Four sets of numbers show information about your session. Use the SELECT keys to choose what information to display.

LEDs: Light and clarify what workout statistics appear on the display.

Keypad: Use the keypad to:

- Select a program
- Answer prompts prior to starting a program
- Adjust the incline or speed

For more information, refer to Keypad.

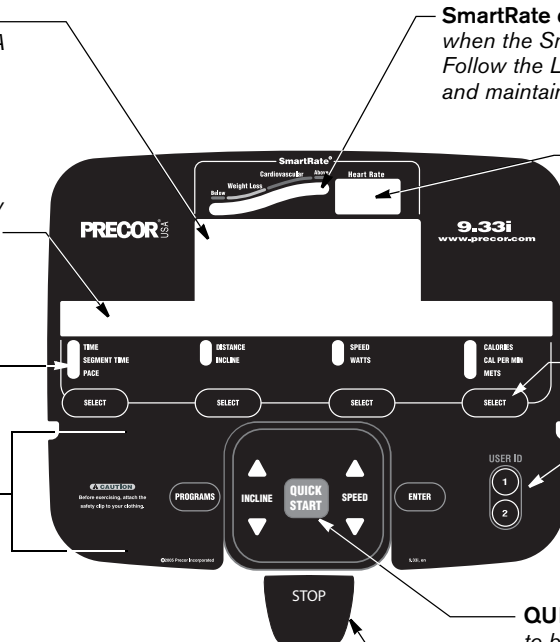

SmartRate display: LEDs light in this column when the SmartRate feature is activated. Follow the LEDs to monitor your heart rate and maintain it in your target zone.

Heart Rate display: If a heart rate is detected, this area displays your heart rate.

SELECT keys: Each key lets you move through the information in each column, choosing what you want to display during your session.

User 1–2: Press a user ID (1–2) at the Precor banner to personalize your workout session. Key workout information is stored between sessions.

QUICKSTART: Press QUICKSTART to begin your workout immediately. It lets you bypass the setup prompts.

Red STOP button: Press to pause a workout or return to the banner.

More Information about the Lower Display

The lower display provides information about your workout session. A number appears over each column of information. You can choose the type of information displayed using the SELECT key below each column. More information about this display is provided below.

Column 1: TIME, SEGMENT TIME, and PACE

TIME—displays workout time in minutes and seconds; however, when you exceed 60 minutes during a single workout, the TIME display converts to hours and minutes. For programs with a workout time limit, the TIME display shows the amount of time remaining. For programs without a workout time limit, the TIME display indicates the amount of time you have been exercising.

SEGMENT TIME—indicates the amount of time, in minutes and seconds (MM:SS), that remains in the highlighted column before the next column begins blinking in the profile.

PACE—displays your target speed in minutes and seconds per mile (or kilometer). For example, the number **4.23** indicates that your requested speed equals 4 minutes and 23 seconds per mile.

Column 2: DISTANCE and INCLINE

DISTANCE—shows linear distance in either miles or kilometers. The distance is calculated based on your speed.

INCLINE—displays the percentage of incline during your workout. The INCLINE ▼ or ▲ keys affect the lift and let you set an incline between 0% and 15%. The values displayed can change in 0.5% increments.

Column 3: SPEED and WATTS

SPEED—displays the running belt speed in miles per hour (mph) or kilometers per hour (kph). The running belt speed ranges from 0.5 and 11 mph (1 to 18 kph) and can be changed in 0.1 increments using the SPEED arrow keys.

WATTS—displays the current mechanical energy generated by the unit.

Column 4: CALORIES, CAL PER MIN, and METS

CALORIES—displays the estimated cumulative number of calories burned. The calorie calculation is derived from the speed, incline, and your weight. An accurate weight entry results in a more accurate calorie count. When using QUICKSTART and a weight has not been specified, the default weight is 150 pounds (68 kilograms).

CAL PER MIN—displays the approximate number of calories burned per minute.

METS—shows the metabolic units associated with your workout.

Keypad

Use the keypad to enter your workout session selections. Keys on the keypad respond to the slightest touch. Use gentle pressure on the keys as you exercise.

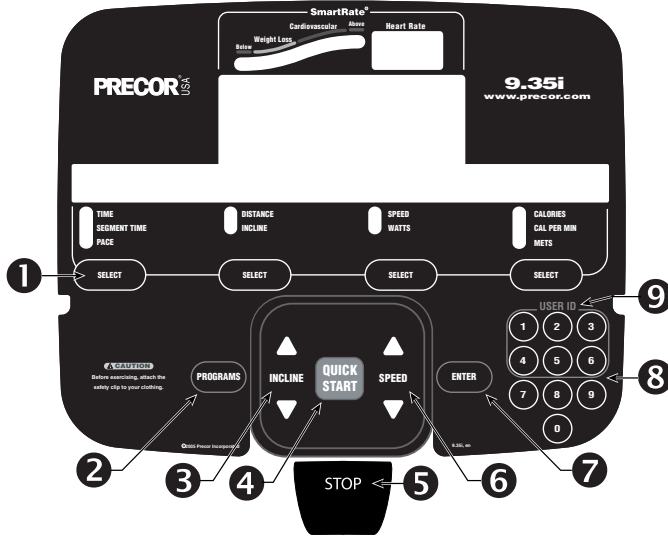

1 SELECT: Four SELECT keys appear on the display console. Each key affects the column above it. While exercising, press a SELECT key to highlight the information that you wish to see in the lower display.

2 PROGRAMS: Press the PROGRAMS key to choose a program. Each time you press the key, a program profile appears in the center display while the name of the program appears in the lower display. Press ENTER to select the displayed program.

Note: If you press the PROGRAMS key at the Precor banner, you bypass identifying yourself with a user ID, so no workout statistics are saved or stored. Refer to *Workout Options*.

3 INCLINE: Press and hold the INCLINE arrow keys to increase or decrease the incline, from 0% to 15%, in 0.5% increments.

During your workout, to view your current incline, tap either INCLINE key. To change the incline, press the arrow key for more than one second.

Changes to the incline are not immediate. It takes time for the lift to reach the target incline shown on the display.

The incline setting affects the column height in the program profile as shown in Diagram 7.

The height of the column indicates the level of incline. Every time the incline changes by four sequential levels (up or down) the height of the column changes by one row.

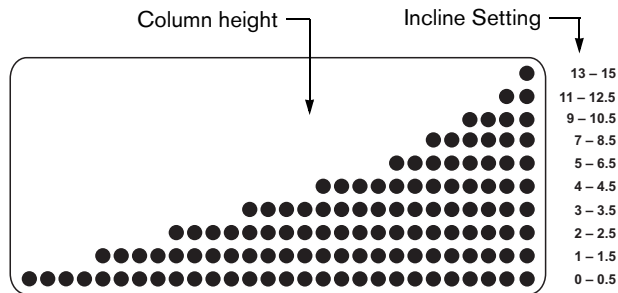

Diagram 7: Column height affected by changes in incline

Note: During the setup phase, pressing the INCLINE arrow keys will not affect the incline. However, the arrow keys do affect what appears on the display. Refer to *Selecting a Program*.

- 4 QUICKSTART:** Press QUICKSTART to bypass the setup prompts and start your workout immediately using the Manual Program. Refer to *Choosing QUICKSTART*.
- 5 STOP:** A firm tap on the red STOP button slows the running belt to a stop and the treadmill enters pause mode. To resume, enter the password and press SPEED ▲. Refer to *Pausing During a Workout or the Cool-Down Period*.

- 6 SPEED:** Press and hold the SPEED arrow keys to increase or decrease the running belt speed, from 0 to 11 mph (1 to 18 kph), in 0.1 increments.

When you press the arrow keys, a target speed appears in the display. The running belt speed changes to meet the target, but the change occurs gradually so the transition is smooth.

During your workout, to view your current speed, tap either SPEED key. To change the speed, press the arrow key for more than one second.

Note: During the setup phase, you can use the SPEED keys to change data. Pressing either arrow key does not affect the speed of the running belt at this time. Refer to *Selecting a Program*.

7 ENTER: Use the ENTER key to confirm responses to workout-specific prompts.

Note: The ENTER key is disabled when the Precor banner is being displayed. You must press QUICKSTART, PROGRAMS, or choose a user ID to begin your workout session. Refer to *Workout Options*.

8 NUMBER KEYS (1–9 and 0): The number keys only appear on the M9.35i. When a user ID is specified, you can use the number keys to change weight, age, and program. You can also use the number keys to specify information for those programs that require input, such as the Distance Goal (19) Program where you specify the total distance you want to travel.

During a workout, you can use the number keys to change speed and incline. Then press the corresponding SPEED or INCLINE key within three seconds to initiate the change.

9 USER ID KEYS:

M9.33i: To personalize your workout session on the M9.33i, press a user ID (1 or 2) at the Precor banner. Using a user ID lets you track your workout statistics from session to session. It also lets you quickly specify age, weight, and program by recalling this information from your prior session. For more information, refer to *Selecting a User ID*.

M9.35i: The M9.35i lets you personalize workout sessions by selecting one of six user IDs (1–6) at the Precor banner. A workout log shows the total time, distance and calories expended to date. Workout statistics and personal information such as age, weight, and preferred program are reinstated as your workout session begins. For more information, refer to *Selecting a User ID*.

Workout Options

CAUTION: Before beginning any fitness program, see your physician for a complete physical examination. Know your physician-recommended heart rate target zone.

1. Turn the unit ON. The Precor banner appears in the center display. The prompt PRESS QUICKSTART OR PRESS PROGRAMS OR PRESS USER ID scrolls in the lower display.



2. Step on the treadmill.
3. Face the display and straddle the running belt.
4. Attach the safety clip to your clothing.

5. Hold on to the handrail with one hand.
6. Select one of the following options:

Option...	Steps...
To start exercising immediately	<ul style="list-style-type: none"> • Use the QUICKSTART key. • Refer to <i>Choosing QUICKSTART.</i>
To view a list of programs	<ul style="list-style-type: none"> • Press PROGRAMS. • Refer to <i>Selecting a Program.</i>
To personalize your exercise session	<ul style="list-style-type: none"> • Use a user ID. • Refer to <i>Selecting a User ID.</i>
To change your workout session displays	<ul style="list-style-type: none"> • Use a user ID or the PROGRAM key. • Refer to <i>Selecting a Program.</i>

Choosing QUICKSTART

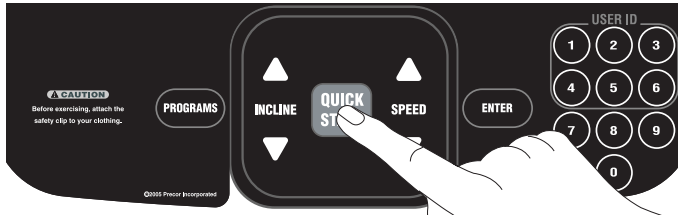

1. Press QUICKSTART at the Precor banner to bypass the setup prompts and start the Manual Program.

QUICKSTART applies the following defaults:

Prompts	Default Value
Program	Manual
Time	No limit (0:00)
Weight	150 lb (68 kg)
Age	0

To use the SmartRate feature, you need to specify your age. In this case, enter a user ID or press PROGRAMS. Follow the setup prompts to enter your age and then press QUICKSTART or ENTER.

Note: To retrieve information about your workout session, specify a user ID at the Precor banner, and then press QUICKSTART. Refer to *Selecting a User ID*.

2. If needed, enter the password by pressing INCLINE ▼, SPEED ▼, and SPEED ▲. An asterisk appears on the display with each entry.
A 3-second countdown appears on the center display, and then the running belt starts moving.
3. Step on to the running belt with the speed at 1 mph (1 kph) and begin your workout. Use the SPEED ▲ to increase the speed of the running belt.

Selecting a User ID

Choosing a user ID enables the treadmill to identify you and, on the M9.35i, track your cumulative workout statistics. It also lets you personalize your workout session and stores information about your preferred program, workout time, weight, and age. The user IDs allow two (M9.33i) to six (M9.35i) people to customize, store, and retrieve workout selections.

The M9.35i treadmill allows you to change the display for a user ID so a name appears. For example, instead of USER 1 showing, you could see Mark or Pam. You might do this to confirm that you have selected the correct user ID if a number of people are using the treadmill. Refer to *Changing a User ID to a Name (M9.35i)*.

1. At the Precor banner, press a user ID key. The user ID appears in the center display.



2. To select a different user ID, press the arrow or user ID keys. On the M9.35i, the workout log that appears with the selected user ID relates to the:
 - total time spent exercising on the treadmill
 - total distance (shown in miles or kilometers)
 - total calories expended while exercising.

3. You have two options:

Option...	Steps...
To start exercising using existing preferences associated with the user ID being displayed.	<ul style="list-style-type: none">• Press QUICKSTART.• Continue to step 3.
To change workout session preferences	<ul style="list-style-type: none">• Press ENTER.• Use the PROGRAMS, arrow, or number keys to select a program.• Press ENTER.• Change your preferences (workout time, weight, and age). The entries are saved with your user ID and reapplied to your workout session the next time you select the same user ID.• Press ENTER. You could also press QUICKSTART to begin.• Continue to step 3.

Note: Press QUICKSTART after any prompt (program, workout time, weight, or age entry) to apply existing user ID preferences to the prompts skipped.

Important: If you make an entry error, press STOP to return to the Precor banner.

4. If needed, enter the password by pressing INCLINE ▼, SPEED ▼, and SPEED ▲. An asterisk appears on the display with each entry.
5. Step on to the running belt and begin your workout. Use the SPEED ▲ to increase the speed of the running belt.

Note: Refer to *Selecting a Program* for more information about choosing a program.

Selecting a Program

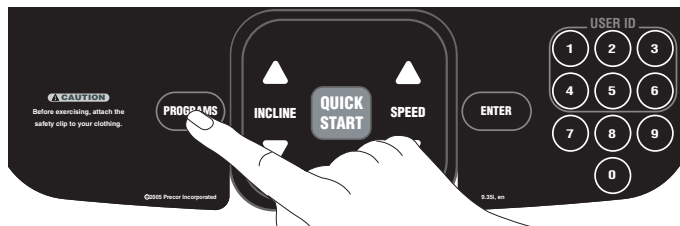

1. At the Precor banner, press PROGRAMS to view a list of the available programs. Refer to the program label on the display console for the program numbers and profiles.

Note: When a program name appears, you can also use the arrow or number keys to change the selection.

2. Select the program you want and then, press ENTER.
Program selection affects what prompts appear. For example, the workout time prompt (step 3) is skipped if you choose WEIGHT LOSS, FITNESS TEST, 5K, 10K, ONE MILE, TWO MILE or a goal-based program. Several of the heart rate programs also require a work interval time entry before prompting for a workout time. For more information, refer to *Programs*.
3. The workout time prompt blinks in the lower display. If a time from the previous exercise session is available, it replaces the default time. Press the arrow keys (or the number keys on the M9.35i) to select a time (between 0 and 240 minutes) and then press ENTER.
Note: If you select a zero time limit, NO LIMIT appears in the display and designates an infinite workout time. If you choose NO LIMIT, remember to incorporate a cool-down period at the end of your workout.

4. Enter your weight (1–999) and then your age (1–99).

Note: You can press QUICKSTART after any of the prompts (program name, work interval, goal, workout time, weight, or age entry). QUICKSTART applies the existing preferences and uses default settings for any prompts skipped. If you press QUICKSTART while a program name is displayed, the workout time is automatically set to 30 minutes.

5. If needed, enter the password by pressing INCLINE ▼, SPEED ▼, and SPEED ▲. An asterisk appears on the display with each entry.

Important: If you make a mistake, press ENTER and reenter the password.

6. Step on to the running belt and begin your workout. Use the SPEED ▲ to increase the speed of the running belt.

Note: You can press QUICKSTART after any of the prompts. QUICKSTART applies existing preferences from the previous workout to any prompts skipped. The running belt begins moving after a 3-second countdown.

Cooling Down After a Workout

Incorporate a cool-down period into your workout to help lower your heart rate and minimize muscle stiffness or soreness.

When you complete a program with a time limit, calorie goal, or distance goal, you automatically enter a 5-minute cool-down period. The Manual Program profile appears in the display. The running belt slows by about 20% and the incline returns to 0%. To adjust the speed or incline, press the arrow keys.

A workout summary appears at the end of the 5-minute cool-down period. See *Ending a Workout*.

Important: If you pressed QUICKSTART, exit a program before completing it, or specify an unlimited time period (NO LIMIT), the cool-down period is bypassed.

To prematurely end the 5-minute cool-down period, do the following:

1. Grasp the handrail with one hand.
2. Press the red STOP button with your other hand. The treadmill enters pause mode.
3. Press STOP to view the workout summary.
4. Press STOP again to return to the Precor banner.

Important: *Hold on to the handrail. Step off the treadmill when the lift has stopped moving.*

Pausing During a Workout or the Cool-Down Period

Press the red STOP button to pause anytime during a workout or during a cool-down period. The pause mode is limited to ten minutes. If you do not resume exercising during that time, the display returns to the banner.

Press the red STOP button a second time to view the workout summary. Press STOP again to return to the Precor banner.

Note: To resume exercising from pause mode, press SPEED ▲. If password protection is enabled, you are prompted for the password.

Ending a Workout

CAUTION: Hold on to the handrail when you near the end of a workout. When the display resets to the banner, the incline is reset to zero. Do not step off the treadmill until the lift has stopped moving.

The treadmill stops the running belt when you complete the automated cool-down period. After the running belt stops, time stops accruing.

On the M9.35i, the distance-based programs show your personal best record when you select a user ID and complete the program.

NEW PERSONAL BEST	displays your best time.
MISSED PERS. BEST	displays the amount of time required to meet or surpass your personal best time.
SAME PERS. BEST	displays the same time as the existing personal best and indicates that you maintained the same workout time.

On the M9.33i and M9.35i, the WORKOUT SUMMARY shows your cumulative workout statistics including warm-up and cool-down periods. Other information including speed and incline reset to zero. You can review your workout statistics for ten minutes before the display resets to the banner.

Note: If you choose to work out with no set time limit, you must manually end a program by pressing the red STOP button. You can also press the SPEED ▼ key until the speed is reduced to zero and the running belt stops.

Important: Do not assume the treadmill is safe because of password protection. Never leave children unsupervised around the treadmill.

Programs

This section describes the programs printed on the M9.33i and M9.35i display labels. The program descriptions are presented in alphabetical order with page number references. Refer to Table 3.

Table 3. Available programs

<i>Program</i>	<i>M9.33i</i>	<i>M9.35i</i>	<i>Page</i>
5k		✓	35
10k		✓	35
Advanced Run	✓		46
Advanced Walk	✓		48
Calories Goal		✓	36
Custom 1 [†]	✓	✓	36
Custom 2 [†]	✓	✓	36
Distance Goal		✓	38
Easy Run	✓		46
Easy Walk	✓		48
Fitness Test*		✓	38
Heart Rate*	✓	✓	41
HR Endurance*		✓	42
HR Heart Health*		✓	42

<i>Program</i>	<i>M9.33i</i>	<i>M9.35i</i>	<i>Page</i>
HR Speed*		✓	42
HR Weight Loss*	✓	✓	42
Interval (adjustable)	✓		44
Interval 1:1		✓	44
Interval 1:2		✓	44
Interval 1:3		✓	44
Manual	✓	✓	45
Moderate Run	✓		46
Moderate Walk	✓		48
One Mile		✓	45
Random	✓	✓	46
Track		✓	47
Two Mile		✓	47
Walk in the Park		✓	48
Weight Loss	✓	✓	49

* Requires the user wear a chest strap.

† Appears when you select a user ID.

Choosing a Program

Choosing a program depends on your goals. If you are a beginner or returning to regular exercise, you can start a cardio-conditioning program to slowly return your body to a comfortable level of exercise. If you have been exercising and feel that you have an intermediate or advanced fitness level, you probably have established goals. The Precor web site (www.precor.com) can give you many ideas about fitness workouts and advice from the experts.

Several workout choices on the treadmill are pre-programmed with recommendations for incline levels, pace, and alternating intervals. You always have the option to override the suggested levels with the exception of the M9.35i Fitness Test.

If your level of exertion becomes too great, reduce your pace or change the incline using the arrow keys to override each upcoming column in the program profile. If you use the arrow keys, the program profile changes accordingly. When you complete a program that contains a time limit or distance limit, an automatic 5-minute cool-down period begins.

Program Tips

- Work out indefinitely in a program. At the ENTER TIME prompt, use the arrow keys to select NO LIMIT or, on the M9.35i, press the number zero. While you exercise, TIME indicates the amount of time you have been exercising. If you choose to exercise without a time limit, the automatic 5-minute cool-down period is eliminated. You will need to incorporate a cool-down period by accessing the Manual Program.

Note: Programs that bypass the ENTER TIME prompt have a fixed time limit or goal.

- If a workout time or goal exists, the TIME display indicates the amount of time remaining in your workout session.
- A blinking column tracks the progress that you make during a program.
- When you select a user ID and a preset program such as Easy Walk or 5K, incline variations in the final column of the program are recorded.
- The interval programs record both incline and speed variations which appear the next time you choose the same interval program and user ID.
- On the M9.35i, the distance-based programs record and show your personal best record when you select a user ID and complete the program.

5K Program



The 5K course is a great program to run or walk depending on your level of fitness. The distance is fixed at five kilometers (3.1 miles) and the incline is preprogrammed. You can change the speed and override the preprogrammed incline using the arrow keys.

A record of your personal best appears when you choose a user ID, select this program, and complete it. Refer to *Ending a Workout*.

10K Program



The distance for the 10K course is fixed at ten kilometers (6.2 miles) and the incline is preprogrammed. You can change the speed and override the preprogrammed incline using the arrow keys.

A record of your personal best appears when you choose a user ID, select this program, and complete it. Refer to *Ending a Workout*.

Calories Goal Program

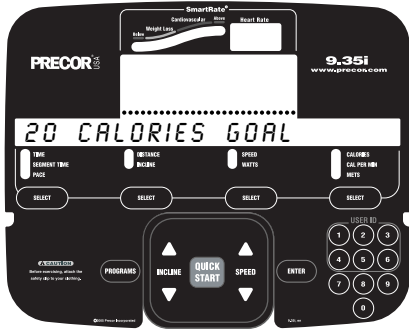

This M9.35i program lets you designate a fixed calorie goal. When you reach your goal, the program ends and the automatic 5-minute cool-down period begins.

After selecting the Calories Goal Program, specify your calorie goal in the blinking CALORIE display. Acceptable entries range from 10 to 5000 calories. Use the arrow keys to change the value, and then press ENTER to begin.

Custom Programs

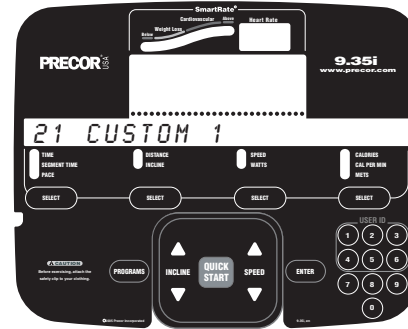

Two custom programs are available with each user ID. As you exercise, you customize the program by determining the speed or incline settings for each 1-minute column along the length of the profile. As each column elapses, the speed and incline for that column are stored in memory.

The subsequent columns repeat the last programmed speed or incline and are reflected in the program profile. Change the speed or incline using the arrow keys. When you complete the program, the settings are automatically recalled using the same user ID and program number.

Note: Custom programs only appear if you select a user ID.

During the program, the TIME display relates to the amount of time remaining in the recorded columns. Total elapsed time appears when you record new columns.

Note: The length of the custom program and the number of speed and incline settings is limited to available memory in the treadmill. The program will not end if the available memory is exhausted, but the display notifies you and further changes to speed or incline are not saved. Approximately 1½ hours of recording time is available.

Clearing the Settings in a Custom Program

Perform the following steps to clear (delete) any speed and incline settings stored in a custom program.

1. At the Precor banner, select a user ID, and then press ENTER.
2. Display the custom program that you wish to clear.
***Important:** Clearing the speed and incline settings from a custom program permanently deletes them from memory.*
3. While the custom program name appears on the display, hold the red STOP button for about fourteen seconds. After the CLEARED message appears on the display, you can release the key. Speed and incline information are reset to zero.

Note: During the 14-second delay and before the CLEARED message appears, you can release the red STOP button and no change will occur to the custom program settings.

Distance Goal Program



This M9.35i program lets you designate a fixed distance. When you reach your goal, the program ends and the automatic 5-minute cool-down period begins.

After selecting the Distance Goal Program, specify your distance goal in the blinking DISTANCE display. Acceptable entries are from 0.1 to 50 (miles or kilometers). Use the arrow keys to change the value, and then press ENTER to begin.

Note: To change the distance settings from mile to kilometers, follow the instructions in *Selecting a U.S. Standard or Metric Display*.

Fitness Test Program



The Fitness Test provides a 15-minute test consisting of five 3-minute sessions. You cannot adjust the speed or incline levels. When you complete the test, the display provides a fitness score and fitness category.

The Fitness Test measures the maximum amount of oxygen (VO_{2max}) the body can use for energy production during exercise. The higher the amount of oxygen that your body can use enhances your ability to exercise for prolonged periods of time. The test results can help you gauge the effectiveness of your current exercise routine and tailor it to meet your fitness goals.

Guidelines

Before selecting the Fitness Test, read the following guidelines:

- Sit and rest for at least five minutes prior to taking the test to bring your heart rate to a resting state.
- The fitness score is affected by your weight and age. You must enter this data during the setup phase.
- You must wear the chest strap throughout the test.
- The arrow keys are disabled during the test. Any pressure on the keys is ignored.

Using the Fitness Test

Let the program adjust the speed of the running belt and incline for you.

CAUTION: If you feel pain, faintness, or dizziness, stop the Fitness Test immediately. You can retake the Fitness Test later.

Completing the Fitness Test

When you finish the Fitness Test, the program slows the speed and returns incline to 0 percent. No automatic cool-down period is provided after the test.

Create your own cool-down period by pressing the QUICKSTART key to enter the Manual program and return your heart rate to a normal, restful state.

The Fitness Test automatically ends if one of the following occurs:

- You press the red STOP button.
- Your heart rate increases and remains for one minute above 85% of the maximum allowable heart rate (220 minus your age).
- Your heart rate cannot be detected.
- You complete the test.

Fitness Test Scores

When you complete the fitness test, your fitness score and cardiovascular fitness level is shown after the workout summary. The score is stored for future retrieval with your user ID. It appears on the display when 9 FITNESS TEST is selected as your desired program.

Note: If you do not receive a fitness score, it could be the result of erratic heart rate readings. Refer to *Troubleshooting Heart Rate*.

Tables 4 and 5 show the desired range in fitness levels depending on your age and gender. More information is available at the Precor web site (www.precor.com).

Table 4. Cardio respiratory Fitness Score Category–Females*

Age in Years	Fitness Category				
	Poor	Fair	Good	Superior	Excellent
30 (or below)	32 (or below)	32–34	35–37	38–41	42 (or above)
30–39	30 (or below)	30–32	33–35	36–39	40 (or above)
40–49	28 (or below)	28–30	31–32	33–36	37 (or above)
50–59	25 (or below)	25–27	28–29	30–32	33 (or above)
60 and over	24 (or below)	24–25	26–27	28–31	32 (or above)

* *The Physical Fitness Specialist Certification Manual*, The Cooper Institute for Aerobics Research, revised 1997.

Table 5. Cardio respiratory Fitness Score Category–Males*

Age in Years	Fitness Category				
	Poor	Fair	Good	Superior	Excellent
30 (or below)	38 (or below)	38–41	42–44	45–48	49 (or above)
30–39	36 (or below)	36–39	40–42	43–47	48 (or above)
40–49	34 (or below)	34 –37	38–40	41–44	45 (or above)
50–59	31 (or below)	31–34	35–37	38–41	42 (or above)
60 and over	27 (or below)	27–30	31–34	35–38	39 (or above)

* *The Physical Fitness Specialist Certification Manual*, The Cooper Institute for Aerobics Research, revised 1997.

Heart Rate Program

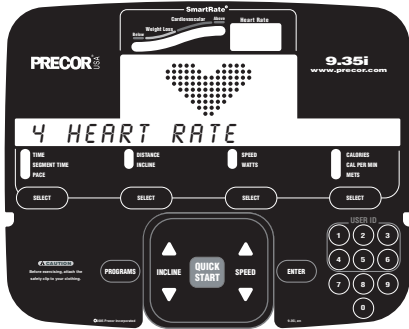

The Heart Rate Program lets you set a target for your heart rate. The program adjusts incline to maintain your heart rate within two beats per minute of the target heart rate while you exercise. To use this program, you must wear the chest strap so the treadmill can monitor your heart rate throughout the session.

During your workout, the number that represents your heart rate appears in the Heart Rate display.

For information about understanding your target heart rate, refer to *Heart Rate Features*.

Important: Consult your physician to determine the appropriate target heart rate for your age and fitness level. If your physician recommends a different target heart rate than the one that appears on the display, use the appropriate **INCLINE** arrow key to change the target heart rate once you finish the warm-up period. Do not work out over the recommended range.

Warm-up Period

The treadmill provides a 3-minute warm-up period. During this time, you may change the speed or incline.

Note: If your heart rate moves into the target heart rate zone during the 3-minute warm-up period, the warm-up period ends and the Heart Rate Program begins.

Using the Heart Rate Program

When you access the Heart Rate Program, the following occurs:

- The treadmill automatically adjusts the incline to keep your heart rate at the selected target. Pressing the INCLINE arrow keys no longer affects the incline of the running bed, but does change the target heart rate. Check the SmartRate display to see if you are maintaining your preferred zone (weight loss or cardiovascular). Check the Heart Rate display to determine your actual heart rate.
- You can change the target heart rate and speed anytime during a workout, but doing so affects the unit's ability to maintain your target heart rate in the preferred zone. It takes time for the treadmill to readjust the incline so that your heart rate remains on target.
- When you complete the program, remember to add a cool-down period.

Note: If you are having difficulty with the heart rate features, refer to *Troubleshooting Heart Rate*.

HR Programs



The heart rate programs have been designed specifically for Precor treadmills by Dr. Emily Cooper of Seattle Performance Medicine. The programs (HR Endurance, HR Heart Health, HR Speed, and HR Weight Loss) are similar to the Heart Rate Program, but the HR programs move you through more specific cardio-conditioning fitness zones. Examples include warm-up, weight loss, cardio-conditioning, peak, and cool down.

Each program adjusts the incline to maintain your heart rate within two beats per minute of the target heart rate while you exercise. To use these programs, you must wear the chest strap so the treadmill can monitor your heart rate throughout the session.

The chart below briefly explains the purpose of each program.

<i>Program</i>	<i>Description</i>
HR Endurance	Increase your aerobic activity and improve heart muscle strength and power. The HR Endurance Program also provides a high intensity workout that enhances your fat-burning capability and increases your endurance. If you are beginning or returning to regular exercise, start with the Heart Rate Program or the HR Weight Loss Program before moving on to the HR Endurance Program.
HR Heart Health	Add variety and increase your endurance. The HR Heart Health Program is a good choice if you have been using the HR Weight Loss program for several weeks and wish to try something different. The HR Health Program keeps you in the weight loss zone 50% of the time and in the cardio-conditioning zone throughout the other half.

<i>Program</i>	<i>Description</i>
HR Speed	Intensify your workout with intervals that consistently increase incline and speed. Be aware the HR Speed Program is an intense program designed to increase your anaerobic threshold and improve your percentage of aerobic capacity. Best results occur if you are already in good physical shape and conditioning.
HR Weight Loss	Improve fat-burning results and increase endurance every time you exercise. Use the HR Weight Loss Program especially if you are beginning exercise routines. It will help you achieve weight loss and increase your aerobic capacity.

Visit our web site www.precor.com for more information and to supplement your workout with additional plans.

Interval Programs

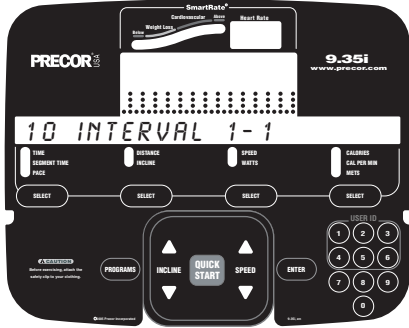

The Interval Programs are among the best for conditioning your cardiovascular system. Each program raises and lowers your level of exertion repeatedly for a specified period of time.

Note: The M9.33i has only one interval program. You can specify the rest and work interval time and adjust the incline and speed throughout the program. Variations in incline and speed are saved when you complete the program if you selected a user ID.

On the M9.35i, three programs let you choose the rest and work intervals according to your training regimen.

<i>Interval Program</i>	<i>Rest Duration</i>	<i>Work Duration</i>
Interval 1:1	1 minute	1 minute
Interval 1:2	1 minute	2 minutes
Interval 1:3	1 minute	3 minutes

Incline is preprogrammed. You can set the speed and change the preprogrammed incline using the arrow keys. The settings are repeated throughout the program.

The display lets you know when the speed or incline levels are about to change, and indicates the levels of the next interval.

When you complete the program, the speed and incline settings are saved with your user ID and applied the next time you select the same Interval Program.

Manual Program

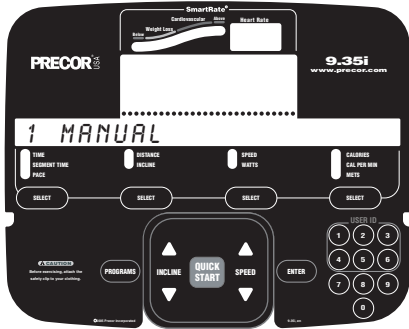

You control speed and incline settings when you use the Manual program. The profile begins as a flat line. Use the arrow keys to change the speed or to adjust the incline. The program profile reflects changes in all subsequent columns. The blinking column indicates your position in the program.

If you press QUICKSTART at the banner and access the Manual program, the workout time is infinite. A cool-down period does not automatically occur when you end your workout. Always remember to incorporate a cool-down period into your workout.

To use the SmartRate feature, you need to specify your age. Refer to *Selecting a Program*.

One Mile Program



The distance is fixed at one mile and the incline is preprogrammed. You can change the speed and override the preprogrammed incline using the arrow keys.

A record of your personal best appears when you choose a user ID, select this program, and complete it. Refer to *Ending a Workout*.

Random Program



Every time the Random Program is selected, a different program profile appears. The columns that appear in the program profile show the preprogrammed incline. You can override the preprogrammed incline at any time using the INCLINE arrow keys.

The incline is preset to zero for the first column. The maximum change allowed between columns is plus or minus 3%.

The running belt speed is completely under your control and can be adjusted using the SPEED arrow keys.

Run Programs

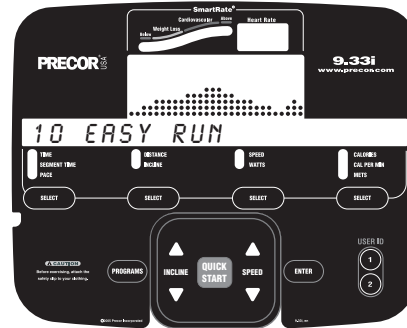

The M9.33i Run Programs provide varying levels of exertion from an easy run (EASY RUN) to a more advanced level (ADVANCED RUN) and have preprogrammed inclines similar to the walk programs. The percentage of incline and the frequency with which the profile changes determine the level of difficulty. You can override the incline level by pressing the INCLINE arrow keys. The change is stored in memory.

The running belt's speed is completely under your control. As you move through the program, the column profile repeats until the time limit is reached.

If you are a runner, visit our web site www.precor.com for more information to supplement your workout.

Track Program



An oval **track** appears on the display; one **lap** around the track represents 440 yards (400 meters). A blinking LED (moving counterclockwise) indicates your position on the track. You control speed and incline. The SEGMENT TIME display shows the remaining time required to complete the current lap based on your current speed.

Two Mile Program



The distance is fixed at two miles and the incline is preprogrammed. You can change the speed and override the preprogrammed incline using the arrow keys.

A record of your personal best appears when you choose a user ID, select this program, and complete it. Refer to *Ending a Workout*.

Walk in the Park Program



This program is similar to the Random Program, because the incline is a fixed profile. You set the workout time during the setup prompts. During your workout, you can change the speed and override the preprogrammed incline using the arrow keys.

Walk in the Park is a relatively easy walk, designed to increase muscle tone, cardio-conditioning, and endurance over several weeks.

Walk Programs



The M9.33i Walk Programs provide varying levels of exertion from an easy walk (EASY WALK) to a more advanced level (ADVANCED WALK) and have preprogrammed inclines. The percentage of incline and the frequency with which the profile changes determine the level of difficulty. You can override the incline level by pressing the INCLINE arrow keys.

The running belt's speed is completely under your control. As you move through the program, the column profile repeats until the time limit is reached.

The walk programs are a great cardio-conditioning program for beginners and serious walkers alike. Visit our web site www.precor.com for more information and to supplement your workout with additional plans.

Weight Loss Program



With the Weight Loss Program, the workout time is fixed at 28 minutes and consists of seven 4-minute intervals. You are not prompted for a workout time. During your workout, use the arrow keys to change the speed or incline during the rest or work interval. When you make changes, the software repeats the settings for the remaining intervals.

For ideal weight loss, your heart rate should be between 55% and 70% of your maximum aerobic heart rate. Set a comfortable pace and adjust the speed and incline to meet the target range. To use this program, you should wear the chest strap so you can monitor your heart rate throughout the session using SmartRate. Refer to *Heart Rate Features*.

Advanced Programming and Troubleshooting

Certain features remain hidden and can only be accessed using special key presses. Read this section if you want to:

- Clear user ID preferences
- Change a user ID to a name
- Change the display to U.S. Standard or Metric
- Enable or disable password protection
- View the odometer
- Display the number of hours you have used your treadmill
- View the software versions and part numbers
- Check the error log
- Display the serial number

Advanced Programming Tips

- Always start at the Precor banner.
- The advanced programming and diagnostic mode is accessed by pressing the red STOP button at the Precor banner. Any remaining key presses must occur quickly and without pause.
- Use the ENTER and arrow keys while in the programming mode.
- If you press STOP instead of ENTER, when changing a user ID to a name, selecting the U.S. or Metric display, or changing password protection, the original setting is left intact.
- The function of the QUICKSTART key is disabled while in programming mode.

Clearing User ID Preferences

You can clear all workout preferences for a user ID. Clearing user preferences restores all programs to their original programmed profile, resets the workout time, weight and age preferences to the original defaults, and on the M9.35i, resets the cumulative workout log to zero.

1. At the Precor banner, select the user ID.
2. Press and hold STOP for about 10 seconds until you see STATISTICS CLEARED on the display.

Preferences and workout statistics are cleared and original programs restored.

Note: On the M9.35i, press and hold STOP for another 6 seconds after the STATISTICS CLEARED message appears to delete the user name.

Changing a User ID to a Name (M9.35i)

When you begin a workout by pressing a user ID, the treadmill confirms by displaying the user ID in the center display. On the M9.35i, you may find it helpful to have the treadmill confirm with a name instead. A user name is limited to five characters. The name "Frank" is acceptable, but "Marcia" is not.

1. Select a user ID. Release the key and then press and hold the number again for 4 seconds. A blinking cursor appears in the center display indicating your starting point. If a name appears, the first character is blinking. The user ID number associated with the user name appears in the lower display.
2. Use the SPEED arrow keys to scroll through the alphabet. When the correct character appears, press INCLINE ▲ to move the cursor right to the next character.
3. When you are done entering the name, press ENTER.
The name change will be retained in memory even if the treadmill is turned OFF and unplugged.
4. Press ENTER to continue through the setup prompts or press STOP to exit to the banner.

Selecting a U.S. Standard or Metric Display

The treadmill can display measurements in either U.S. Standard or Metric. When the treadmill is shipped from the factory it is set to display U.S. Standard. To change this setting, perform the following steps:

1. At the Precor banner, press the following keys in sequence and without pause:

<i>Treadmill</i>	<i>Key Sequence</i>
M9.35i	STOP, 5, 6, 7, 1
M9.33i	STOP, SPEED ▼, SPEED ▲, ENTER, PROGRAMS

The numbers 5, 6, 7, 1 appear on the display as you press the associated key.

2. SELECT UNITS appears, followed by the current unit of measure. Use an arrow key to switch between the options.
3. Press ENTER to accept the displayed setting.

The change will be retained in memory even if the treadmill is turned OFF and unplugged.

4. To continue programming the treadmill to change password protection, refer to *Selecting Password Protection*.
5. If you want to end programming, press STOP.

Selecting Password Protection

Note: The password protection program is part of a two-part sequence that starts with the steps found in *Selecting a U.S. Standard or Metric Display*.

- At the PASSWORD prompt, specify PASSWORD ENABLED or PASSWORD DISABLED, using the arrow keys to switch between settings.

<i>Setting</i>	<i>Description</i>
ENABLED	Causes the password prompt to appear prior to a workout and when returning from pause mode.
DISABLED	Lets you turn off the password prompt. Use this setting with caution.

CAUTION: Precor recommends that you leave the password protection enabled. If you choose to change the security of the treadmill, it is your responsibility to make sure that no unauthorized personnel or children are allowed on or near the treadmill.

- Press ENTER to accept the displayed setting and return to the Precor banner.

The change will be retained in memory even when the treadmill is turned OFF and unplugged.

Informational Displays

The treadmill provides information about its use (odometer and hour meter), as well as software version, error codes, and serial number. In general, you would only access this information if directed to do so by Precor Customer Support.

These instructions guide you through all five informational displays. Pressing the ENTER key moves you through the displays. To exit, press and hold STOP at any time.

Important: Quick access to the informational displays is available if error messages have appeared on the display and have been recorded in the error log. This feature is usually reserved for service personnel. At the Precor banner, press and hold STOP for 4 seconds. Review the information in Viewing the Odometer and continue with step 2.

Viewing the Odometer

1. At the Precor banner, press the following keys in sequence and without pause:

<i>Treadmill</i>	<i>Key Sequence</i>
M9.35i	STOP, 6, 5
M9.33i	STOP, SPEED ▲, SPEED ▼

Numbers 6, 5 appear on the display as you press the associated key.

Then ODOMETER appears on the display followed by the odometer value (cumulative miles users have traveled).

Note: If the unit of measure is set to metric, then KILOMETERS appears instead of MILES.

2. When you are ready, press ENTER to move to the next display (hour meter).

Viewing the Hour Meter

HOUR METER appears on the display followed by the number of hours that the unit has been in use. The treadmill tracks the elapsed minutes, but the value that appears is truncated to the nearest full hour.

3. When you are ready, press ENTER to move to the next display (software version).

Viewing the Software Version and Part Numbers

SW VERSION appears on the display followed by the upper board software version and part number (for example, 47475-205).

4. To see the upper application serial number, upper boot part number, lower board's serial number, and upper application software part number use the arrow keys. If needed, you can move through all four—upper application, upper boot, lower board, and upper application software—using the arrow keys.

5. Write the numbers below. You will need these numbers when you call Customer Support with display-related questions. This information will help rule out any software-related problems:

UPPER APP: _____

UPPER BOOT: _____

LOWER: _____

UPPER APP: _____

6. When you are ready, press ENTER to move to the next display (error log).

Viewing the Error Log

ERROR LOG appears on the display followed by the first entry in the error log if there are any errors. Up to ten error codes can be retrieved.

If there are no errors in the log, you will see NO ERRORS displayed.

7. To view any additional error codes in the error log, use the arrow keys. Each error code specifies when it occurred, listing the odometer and hour meter values. Refer to Diagram 7.

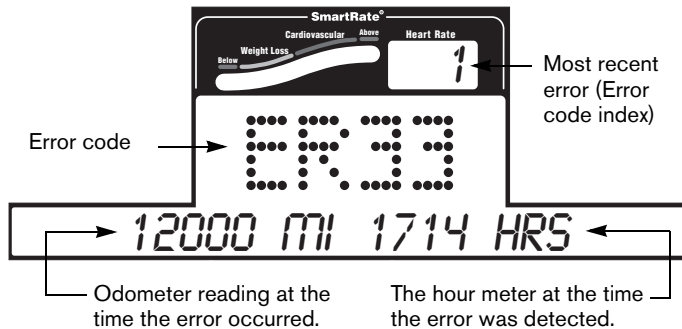

Diagram 7: Error log

8. Copy the error code information to paper so you can provide it to Customer Support if needed. Be sure to copy it exactly as shown.
9. When you no longer need the information in the error log, press QUICKSTART to erase the error log. While the error log is displayed, maintain light pressure on the QUICKSTART key. HOLD TO CLEAR ERRORS appears. Continue to maintain pressure on the key. Messages appear on the display to let you know when the error log has been cleared.

Important: You cannot retrieve the error log once you have cleared it. You may want to resolve any issues you are experiencing with the treadmill before clearing the error log.

10. When you are ready, press ENTER to move to the next display (serial number).

Viewing the Serial Number

SERIAL NUMBER appears on the display followed by the 13-digit serial number associated with the treadmill. The serial number is helpful when you contact Customer Support.

Note: If no serial number has been entered, then NO SERIAL NUMBER appears. Use the serial number found on the front panel, near the power cord.

11. If you have not already done so, write the serial number onto the Warranty Registration card. You can also register online at www.precor.com.
12. When you are ready, press ENTER to return to the Precor banner.

Troubleshooting Error Codes

If any error codes appear in the center display, turn the unit OFF and ON. If the error continues to occur, call an authorized service person for assistance. Refer to *Obtaining Service*.

Troubleshooting Heart Rate

Table 6 may help you understand and troubleshoot erratic heart rate readings.

Important: A heart rate can only be detected when the Precor heart rate receiver is properly installed in the display and the treadmill is turned on. You must also wear the chest strap or hold on to both touch-sensitive handrail grips.

Table 6. Erratic heart rate readings

<i>What appears on the display</i>	<i>Cause</i>	<i>What to Do</i>
Nothing	The heart rate receiver is not installed or it has been disconnected.	To receive Customer Support, refer to <i>Obtaining Service</i> .
---	A signal is being detected, but the transmission requires more time to establish a heart rate.	Be sure the chest strap is in direct contact with your skin. If using the grips, use both hands and make sure your hands are moist, not dry.
Pulsing HR LED	The LED lights briefly when a heart beat is detected.	If the LED is pulsating, it indicates that the heart rate equipment is working properly.

Note: To conduct electrical impulses from a user's heart, both touch-sensitive handrail grips must be grasped firmly for five to ten seconds. Usually, the concentration of salts in a person's perspiration provides enough conductivity to transmit a signal to the receiver in the display console. However, because of body chemistry or erratic heartbeats, some people cannot use the heart rate feature. A chest strap may provide better results. Refer to the *QuickStart Card* for proper placement of the chest strap.

Maintenance

It is important to perform the minor maintenance tasks described in this section. Failure to maintain the treadmill as described here could void the Precor Limited Warranty.

DANGER To reduce the risk of electrical shock, always unplug the unit from its power source before cleaning it or performing any maintenance tasks.

Inspection

Inspect the treadmill daily.

1. Look and listen for slipping belts, loose fasteners, unusual noises, worn or frayed power cords, and any other indications that the equipment may be in need of service. If you notice any of these, obtain service.

Important: *If you determine that the treadmill needs service, ensure that the treadmill cannot be used inadvertently. Turn the unit OFF, and then unplug the power cord from its power source. Make sure other users know that the treadmill needs service.*

2. Check for worn, frayed or missing safety lanyards. Replace missing or worn safety lanyards immediately. Do not exercise on the treadmill without attaching the safety clip to your clothing.

To order parts or to contact a Precor authorized service provider in your area, refer to *Obtaining Service*.

Cleaning the Equipment

Most of the working mechanisms are protected inside the hood and base of the treadmill. However, for efficient operation, the treadmill relies on low friction. To keep the friction low, the unit's running belt, staging platforms, and internal mechanisms must be as clean as possible.

Precor recommends the treadmill be cleaned before and after each workout. Use mild soap and water to dampen a soft cloth and wipe all exposed surfaces. This helps remove any dust or dirt.

CAUTION: Do not use any acidic cleaners. Doing so will void the Precor Limited Warranty. Never pour water or spray liquids on any part of the treadmill. Allow the treadmill to dry completely before using.

Periodically, clean the running belt using a soft nylon scrub brush. Frequently vacuum the floor underneath the unit to prevent the accumulation of dust and dirt, which can affect the smooth operation of the unit.

Storing the Chest Strap

Store the chest strap where dust and dirt cannot accumulate on it, such as a closet or drawer. Be sure to keep the chest strap protected from extremes in temperature. Do not store it in an area that may be exposed to temperatures below 32° F (0° C).

To clean the chest strap, use a sponge or soft cloth dampened in mild soap and water. Dry the surface thoroughly with a clean towel.

Checking the Alignment of the Running Belt

Proper belt alignment allows the belt to remain centered and ensures smooth operation. Realigning the belt takes a few simple adjustments. If you are unsure about this procedure, call Precor Customer Support. Refer to *Obtaining Service*.

CAUTION: Special care must be taken when aligning the running belt. Turn OFF the treadmill while adjusting or working near the rear roller. Remove any loose clothing and tie back your hair. Be very careful to keep your fingers and any other object clear of the belt and rollers, especially in front of the roller and behind the deck. The treadmill will not stop immediately if an object becomes caught in the belt or rollers

1. The treadmill has adjustable rear feet. Make sure that the running surface is level. If the treadmill is placed on an uneven surface, adjusting the rear feet can help, but will not compensate for extremely uneven surfaces.
2. Turn the unit ON.
3. Stand beside the treadmill and press QUICKSTART.

4. If needed, enter the password by pressing the following keys in sequence INCLINE ▼, SPEED ▼, SPEED ▲.

The running belt starts automatically after a 3-second countdown appears on the display.

5. Press the SPEED ▲ key until the display shows a speed of 3 mph (5 kph).

CAUTION: If you hear any chafing or the running belt appears to be getting damaged, stop the running belt immediately by pressing the red STOP button. Contact Precor Customer Support.

6. Walk around to the rear of the unit and observe the belt for a few minutes. The belt should be centered on the running belt. If the belt drifts off center, you must make adjustments.

Important: *If the belt needs alignment, make the adjustments at once. Failure to align the belt may cause the belt to tear or fray, which is not covered by the Precor Limited Warranty.*

7. To stop the running belt, press the red STOP button.
8. Turn the treadmill OFF.

Adjusting the Running Belt

If you are unsure about adjusting the running belt, call Precor Customer Support (refer to *Obtaining Service*).

CAUTION: For your safety, use the I/O power switch to turn OFF the treadmill before making any adjustments. Do not adjust the running belt when someone is standing on the unit.

1. Locate the right belt adjustment bolt in the rear end cap of the treadmill. Make all belt adjustments on the right rear corner bolt using the hex key provided. Refer to Diagram 8.

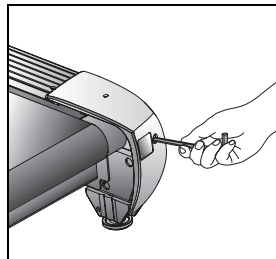

Diagram 8: Location of the adjustment bolt

- If the belt is off center to the LEFT, turn the adjusting bolt $\frac{1}{4}$ turn *counterclockwise*, which moves the running belt to the right.
- If the belt tracks off center to the RIGHT, turn the bolt $\frac{1}{4}$ turn *clockwise*; this moves the belt to the left.

Important: Do not turn the adjusting bolt more than $\frac{1}{4}$ turn at a time. Overtightening the bolt can damage the treadmill.

2. Recheck the alignment of the running belt.

Servicing the Treadmill

Do not attempt to service the treadmill yourself except for the maintenance tasks described in this manual. The unit does not contain any user-serviceable parts that require lubrication. For information about product operation or service, see the Precor website at www.precor.com.

Long-Term Storage

When the treadmill is not in use for any length of time, turn it OFF. Make sure that the power cord is unplugged from its power source and is positioned so that it will not become damaged or interfere with people or other equipment.

Precor Residential Equipment Limited Warranty

PLEASE READ THESE WARRANTY TERMS AND CONDITIONS CAREFULLY BEFORE USING YOUR PRECOR INCORPORATED PRODUCT. BY USING THE EQUIPMENT, YOU ARE CONSENTING TO BE BOUND BY THE FOLLOWING WARRANTY TERMS AND CONDITIONS.

Limited Warranty

Precor Incorporated warrants all new Precor products to be free from defects in materials and manufacture for the warranty period set forth below. The warranty period commences on the invoice date of original purchase. This warranty applies only against defects discovered within the warranty period and extends only to the original purchaser of the product. Parts repaired or replaced under the terms of this warranty will be warranted for the remainder of the original warranty period only. To make claim under warranty, the buyer must notify Precor or their authorized Precor dealer within 30 days after the date of discovery of any nonconformity and make the affected product available for inspection by Precor or its service representative. Precor's obligations under this warranty are limited and set forth below.

Warranty Periods and Coverage

All residential products and commercial products used in the home are warranted for the following periods:

- Lifetime frame and welds
- 10 years parts and wear items
- 1 year labor
- Coverage for options and accessories defined below.

Options / Accessories

Many options or accessories have components that are connected internally or mounted inside the electronic console. The following guidelines determine the warranty for these components. If the internal components are installed by the factory or by an authorized dealer as part of the original sale and delivery, they have a warranty that is identical to the warranty of the equipment in which they are connected or mounted. If the internal components are not installed by the factory or by an authorized dealer as part of the original sale and delivery, they have a 90-day parts and labor limited warranty. All components that are not internally connected have 90-day parts only limited warranty. Satisfactory proof of purchase is required in all cases.

Conditions and Restrictions

This warranty is valid only in accordance with the conditions set forth below:

1. The warranty applies to the Precor product only while:
 - a. It remains in the possession of the original purchaser and proof of purchase is demonstrated
 - b. It has not been subjected to accident, misuse, abuse, improper service, or non-Precor modifications
 - c. Claims are made within the warranty period
2. This warranty does not cover damage or equipment failure caused by electrical wiring not in compliance with electrical codes or Precor owner's manual specifications, or failure to provide reasonable and necessary maintenance as outlined in the owner's manual.
3. Warranty of all Precor products applies to residential use only and is void when products are used in a nonresidential environment or installed in a country other than where sold.
4. Except in Canada, Precor does not pay labor outside the United States.
5. Warranties outside the United States and Canada may vary. Please contact your local Dealer for details.

This limited warranty shall not apply to:

1. Software version upgrades
2. Cosmetic items, including, but not limited to the following: grips, seats, and labels.
3. Repairs performed on Precor equipment missing a serial number or with a serial tag that has been altered or defaced.
4. Service calls to correct installation of the equipment or instruct owners on how to use the equipment.
5. Pickup, delivery, or freight charges involved with repairs.
6. Any labor costs incurred beyond the applicable labor warranty period.

Disclaimer and Release

The warranties provided herein are the exclusive warranties given by Precor and supersede any prior, contrary or additional representations, whether oral or written. ANY IMPLIED WARRANTIES, INCLUDING THE WARRANTY OF MERCHANTABILITY OR FITNESS FOR A PARTICULAR PURPOSE THAT APPLY TO ANY PARTS DESCRIBED ABOVE ARE LIMITED IN DURATION TO THE PERIODS OF EXPRESS WARRANTIES GIVEN ABOVE FOR THOSE SAME PARTS. PRECOR HEREBY DISCLAIMS AND EXCLUDES THOSE WARRANTIES THEREAFTER. Some states do not allow limitation on how long an implied warranty lasts, so the above limitation may not apply to you. PRECOR ALSO HEREBY DISCLAIMS AND EXCLUDES ALL OTHER OBLIGATIONS OR LIABILITIES, EXPRESS OR IMPLIED, ARISING BY LAW OR OTHERWISE, WITH RESPECT TO ANY NONCONFORMANCE OR DEFECT IN ANY PRODUCT, INCLUDING BUT NOT LIMITED TO: (A) ANY OBLIGATION, LIABILITY, RIGHT, CLAIM OR REMEDY IN TORT, WHETHER OR NOT ARISING FROM THE NEGLIGENCE OF PRECOR OR ITS SUPPLIERS (WHETHER ACTIVE, PASSIVE OR IMPUTED); AND (B) ANY OBLIGATION, LIABILITY, RIGHT, CLAIM, OR REMEDY FOR LOSS OF OR DAMAGE TO ANY EQUIPMENT. This disclaimer and release shall apply even if the express warranty set forth above fails of its essential purpose.

Exclusive Remedies

For any product described above that fails to conform to its warranty, Precor will provide, at their option, one of the following: (1) repair; (2) replacement; or (3) refund of the purchase price. Precor Limited Warranty service may be obtained by contacting the authorized dealer from whom you purchased the item. Precor compensates Servicors for warranty trips within their normal service area to repair equipment at the owner's location. You may be charged a trip charge outside the service area. THESE SHALL BE THE SOLE AND EXCLUSIVE REMEDIES OF THE BUYER FOR ANY BREACH OF WARRANTY.

Exclusion of Consequential and Incidental Damages

PRECOR AND/OR ITS SUPPLIERS SHALL HAVE NO OBLIGATION OR LIABILITY, WHETHER ARISING IN CONTRACT (INCLUDING WARRANTY), TORT (INCLUDING ACTIVE, PASSIVE, OR IMPUTED NEGLIGENCE AND STRICT LIABILITY), OR OTHERWISE, FOR DAMAGE TO THE EQUIPMENT, PROPERTY DAMAGE, LOSS OF USE, REVENUE OR PROFIT, COST OF CAPITAL, COST OF SUBSTITUTE EQUIPMENT, ADDITIONAL COST INCURRED BY BUYER (BY WAY OF CORRECTION OR OTHERWISE) OR ANY OTHER INCIDENTAL, SPECIAL, INDIRECT, OR CONSEQUENTIAL DAMAGES, WHETHER RESULTING FROM NONDELIVERY OR FROM THE USE, MISUSE OR INABILITY TO USE THE PRODUCT. This exclusion applies even if the above warranty fails of its essential purpose and regardless of whether such damages are sought for breach of warranty, breach of contract, negligence, or strict liability in tort or under any other legal theory. Some states do not allow the exclusion or limitation of incidental or consequential damages, so the above limitation might not apply.

This warranty gives you specific legal rights, and you may also have other rights, which vary state to state.



Thank You and Welcome to Precor

PRECOR[®]USA
move beyond[®]

To allow us to serve you better, please take a few moments to complete and return your warranty registration.

YOU MAY ALSO REGISTER ONLINE AT

www.precor.com/warranty

If you have questions or need additional information, contact your local dealer or call Precor Customer Support at 800-347-4404.

Fold along dotted line and tape closed before mailing.

RET.

PRECOR[®]USA
Precor Incorporated
20031 142nd Avenue NE
PO Box 7202
Woodinville, WA 98072-4002

PLACE
STAMP
HERE





TELL US ABOUT YOUR NEW PRECOR PRODUCT

Date of Purchase: _____
Month Day Year

Product Serial Number: _____
The serial number is located on the shipping box and on the product.

Purchased from: _____
Dealer Name

Please indicate the type of product purchased:

- | | |
|--|--|
| <input type="checkbox"/> Elliptical Fitness CrossTrainer™ (EFX®) | <input type="checkbox"/> StretchTrainer™ |
| <input type="checkbox"/> Treadmill | <input type="checkbox"/> Cycle |
| <input type="checkbox"/> Strength Training System | <input type="checkbox"/> Stair Climber |

TELL US ABOUT YOU

Mr.
 Mrs.
 Ms.

First Name Middle Initial Last Name

Street Address Apt./Suite:

City State Zip Code

Area Code Telephone

Your Email Address

- | | | | | |
|--|--|--|--|--|
| Gender:
<input type="checkbox"/> Male
<input type="checkbox"/> Female | Marital status:
<input type="checkbox"/> Married
<input type="checkbox"/> Divorced
<input type="checkbox"/> Widowed
<input type="checkbox"/> Never been married | Age:
<input type="checkbox"/> Under 18
<input type="checkbox"/> 18-24
<input type="checkbox"/> 25-34
<input type="checkbox"/> 35-44
<input type="checkbox"/> 45-54
<input type="checkbox"/> 55-64
<input type="checkbox"/> 65+ | Annual household income:
<input type="checkbox"/> Under \$50,000
<input type="checkbox"/> \$51,000-75,000
<input type="checkbox"/> \$76,000-100,000
<input type="checkbox"/> \$101,000-150,000
<input type="checkbox"/> \$151,000+ | What are your fitness goals?
<input type="checkbox"/> Weight loss/management
<input type="checkbox"/> Muscle tone enhancement
<input type="checkbox"/> Cardiovascular improvement
<input type="checkbox"/> Overall health
<input type="checkbox"/> Increase energy and flexibility
<input type="checkbox"/> Stress reduction
<input type="checkbox"/> Rehabilitation
<input type="checkbox"/> Other |
|--|--|--|--|--|

TELL US ABOUT YOUR PURCHASE

Purchase (check all that apply):

- First Precor product
- Replaces a Precor product of the same type
- Replaces same type of product – different brand
- Addition to equipment currently owned

What factors MOST influenced your decision to purchase your Precor product (choose up to three):

- | | |
|---|---|
| <input type="checkbox"/> Precor reputation | <input type="checkbox"/> Rebate or sale price |
| <input type="checkbox"/> Prior use of Precor product(s) | <input type="checkbox"/> Quality/durability |
| <input type="checkbox"/> Design/appearance | <input type="checkbox"/> Warranty |
| <input type="checkbox"/> Special product features | <input type="checkbox"/> Value for the price |
| <input type="checkbox"/> Physician recommendation | |

How did you FIRST become aware of Precor products (choose only one):

- A gift
- Friend/relative
- Physician
- Fitness club
- Internet
- News report or product review
- Magazine advertisement or article
- Print advertisement
- In-store display or demonstration
- Other

Effective 28 June 2004
P/N 45623-102

Please detach and mail in the warranty registration within ten days of purchase.



M9.3xi Low Impact Treadmills

Product Specifications

Length:	79 in (201 cm)
Width:	34 in (84 cm)
Height:	55 in (140 cm)
Weight:	285 lb (130 kg)
Shipping weight:	350 lb (159 kg)
Running surface:	57 in x 20 in (145 cm x 51 cm)
Motor:	3.0 hp Continuous duty
Power:	120 VAC, 50/60Hz
Speed:	0.5–11 mph (1–18 kph)
Incline:	0%–15% grade
Frame:	Powder-coated steel
Regulatory Approvals:	FCC, ETL, CE

Product Features

	M9.33i	M9.35i
CSAFE Compatible	✓	✓
QUICKSTART™	✓	✓
Reversible Deck	✓	✓
SmartRate®	✓	✓
Touch-Sensitive Display	✓	✓
Heart Rate Telemetry (chest strap included)	✓	✓
Touch Heart Rate	✓	✓
User IDs	2	6
Password Protection	✓	✓
Workout Log		✓

Programs

	M9.33i	M9.35i
10K		✓
5K		✓
Advanced Run	✓	
Advanced Walk	✓	
Calories Goal		✓
Custom 1	✓	✓
Custom 2	✓	✓
Distance Goal		✓
Easy Run	✓	
Easy Walk	✓	
Fitness Test		✓
Heart Rate*	✓	✓
HR Endurance*		✓
HR Heart Health*		✓
HR Speed*		✓
HR Weight Loss*	✓	✓
Interval (adjustable)	✓	
Interval 1-1		✓
Interval 1-2		✓
Interval 1-3		✓
Manual	✓	✓
Moderate Run	✓	
Moderate Walk	✓	
One Mile		✓
Random	✓	✓
Track		✓
Two Mile		✓
Walk in the Park		✓
Weight Loss	✓	✓

Display Readouts

	M9.33i	M9.35i
Calories	✓	✓
Calories per Minute	✓	✓
Distance	✓	✓
Heart Rate*	✓	✓
Incline	✓	✓
METs	✓	✓
Pace	✓	✓
Profile	✓	✓
Segment Time	✓	✓
SmartRate*	✓	✓
Speed	✓	✓
Time	✓	✓
Watts	3	3

* Chest strap required.



Precor Incorporated
20031 142nd Ave NE
P.O. Box 7202
Woodinville, WA USA 98072-4002

Precor, C, CrossRamp, EFX, M, Move Beyond, and SmartRate are registered trademarks of Precor Incorporated. Crosstrainer, QuickStart, and StretchTrainer are trademarks of Precor Incorporated. Copyright 2005 Precor Incorporated. Specifications subject to change without notice.
www.precor.com

NOTICE:

Precor is widely recognized for its innovative, award winning designs of exercise equipment. Precor aggressively seeks U.S. and foreign patents for both the mechanical construction and the visual aspects of its product design. Any party contemplating the use of Precor's product designs is hereby forewarned that Precor considers the unauthorized appropriation of its proprietary rights to be a very serious matter. Precor will vigorously pursue all unauthorized appropriation of its proprietary rights.

Download from Www.Somanuals.com. All Manuals Search And Download.

M9.33i/M9.35i OM 48853-102, en
Warranty # 36287-110, en
Registration Card# 45623-102, en
7 December 2005

QUICKSTART™

CAUTION: Before using the treadmill, read all these instructions. Failure to do so may result in serious injury.

- Do not allow children or those unfamiliar with its operation on or near the treadmill.
- Before beginning any fitness program, see your physician for a thorough physical examination. Seek advice from your physician to learn the target heart rate appropriate for your fitness level.
- At the beginning of a workout, straddle the belt by placing your feet firmly on the right and left staging platforms.
- Always face the display and use the handrail for balance. Never attempt to turn around on the treadmill while the running belt is moving.
- If you feel pain, faintness, or dizziness, stop exercising immediately.

Use the Safety Clip

Always attach the safety clip to your clothing before each workout. A tug on the lanyard trips the safety switch inside the display and stops the running belt. If the safety switch trips while you are exercising, the treadmill retains your workout statistics and enters pause mode. To resume your workout, reattach the safety clip to your clothing, enter the password, and then press the SPEED ▲ key.

9.33i 9.35i Low-Impact Treadmills

Workout Tips

- Before and after a workout, gently stretch your lower body and back to help prevent stiffness or soreness.
- At the beginning of a workout, take several minutes to bring your heart rate into your target zone (shown in Diagram D on the other side of this card).
- Incorporate a cool-down period into your workout to help lower your heart rate and minimize muscle stiffness and soreness.
- Keys on the keypad respond to the slightest touch. Use gentle pressure on the keys as you exercise.
- To display your heart rate, wear a chest strap or use both hands to grasp the touch-sensitive handrail grips.

Begin Your Workout with QUICKSTART

1. Turn ON the treadmill, using the I/O power switch on the front panel.
2. Step on the treadmill.
3. Face the display and straddle the running belt.
4. Attach the safety clip to your clothing.
5. Hold on to the handrail with one hand.
6. Press QUICKSTART.
7. If needed, enter the password. Refer to your owner's manual.
A 3-second countdown appears, and then running belt starts moving. The Manual Program begins.
8. Step on to the running belt with the speed at 1 mph (1 kph), and begin exercising.
 - To increase the belt speed, press SPEED ▲.
 - To increase or decrease the incline or speed, use the INCLINE or SPEED arrow keys.
 - To pause, press the red STOP button.
9. Enter a cool-down period by lowering the speed and incline. End your workout by pressing STOP.
10. Press STOP again to display your workout summary. The display show your cumulative time, distance, and the number of calories burned during your workout.
11. Remove the safety clip from your clothing and hold on to the handrail as you step off the treadmill.
12. To prevent unauthorized use, turn the treadmill OFF.

Choose a Program

- Determine your level of fitness: beginner, intermediate, or advanced.
- Determine your immediate goal: endurance training, cardio-conditioning, or weight loss.

If you are a beginner, start a cardio-conditioning program to slowly adjust your body to a comfortable level of exercise. Over a recommended 8-week period, you will increase your endurance and strength while improving flexibility.

If you have been exercising and feel that you have reached an intermediate or advanced fitness level, you probably have established goals for yourself.

For all fitness levels, plan to exercise at a comfortable pace for 20 to 30 minutes a day. Wear a chest strap to monitor your heart rate. Supplement your plans with fitness workouts from the Precor website (www.precor.com). The Precor website provides numerous fitness workouts and expert advice to help you reach your fitness goals.

Wear a Chest Strap

During a workout, the heart rate features appear on the display when you wear a chest strap. To receive an accurate reading, the strap needs to be in direct contact with your skin. Be sure to wear the chest strap underneath your clothing.

Note: The Precor heart rate receiver must be properly installed in the display console before a heartbeat can be detected. Check with your dealer to make sure it is installed in your product.

1. Carefully dampen the back of the strap with tap water (Diagram A).
***Important:** Do not use deionized water. It does not have the proper minerals and salts to conduct electrical impulses.*
2. Adjust the strap and fasten it around your chest. The strap should feel snug, not restrictive (Diagram B).
3. Make sure that the chest strap is right side up, lies horizontally across your chest, and is centered in the middle of your chest (Diagram C).



Diagram A

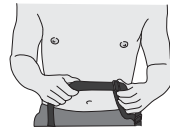

Diagram B

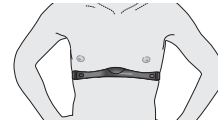

Diagram C

When these steps are complete, you are ready to view your heart rate!

SmartRate® and Heart Rate Features

The SmartRate and heart rate displays provide visual cues that help you adjust your fitness routine to reach your goals. Use these features to keep your heart rate within the target zones for weight loss or cardio-conditioning.

When you begin a workout, a blinking segment in the SmartRate display appears if you entered your age during the setup phase. The blinking segment indicates the current zone of your heart rate: weight loss or cardiovascular. For the ideal weight loss range, your heart rate should remain between 55% and 70% of your maximum aerobic heart rate. To improve your overall cardiovascular and respiratory fitness level, maintain your heart rate between 70% and 85% of your maximum aerobic heart rate.

For the greatest benefits, maintain your heart rate in either zone (weight loss or cardiovascular) for 30 minutes or more at least three times a week.

CAUTION: Your heart rate should never exceed 85% of your maximum aerobic heart rate or go above your target zone (Diagram D).

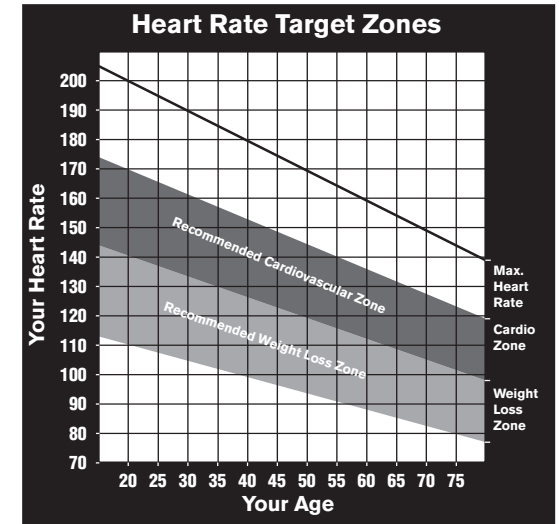

Cool Down After Your Workout

Cooling down is an important aspect of your workout because it helps reduce muscle stiffness and soreness by transporting excess lactic acid out of the working muscles. Cooling down for at least three minutes helps provide a smooth transition that allows your heart rate to return to its normal, non-exercising state.

Assembly Guide



PRECOR[®] USA
move beyond[®]

/// 9.33i
/// 9.35i
Low-Impact Treadmills

Thank you for choosing Precor. For proper installation, please read this guide thoroughly and follow the assembly instructions. If you do not assemble the treadmill according to these guidelines, you could void the Precor Limited Warranty.

Obtaining Service

You should not attempt to service the treadmill except for minor belt adjustments and maintenance as described in the owner's manual. If any items are missing, contact your dealer. Should you need more information regarding Customer Support numbers or a list of Precor authorized Service Centers, visit the Precor website at www.precor.com.

Unpacking the Equipment

The treadmill is carefully tested and inspected before shipment. The unit is shipped in one box. Ask for help from two or more people to unpack and assemble the treadmill.

Required Tools

- 1/2-inch box end or crescent wrench
- String
- Tape
- Wire tie cutter







Installation Requirements

Follow these installation requirements when assembling the unit:

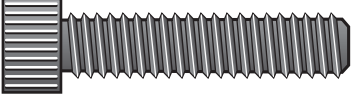
- **Assemble the unit near the location where you plan to use it.**
- **Provide ample space around the unit.**
Open space around the unit allows for easier access.
- **Set up the unit on a solid, flat surface.**
A smooth, flat surface under the unit helps keep it level. A level unit has fewer malfunctions.
- **Open the box and assemble the components in the sequence presented in this guide.**
- **Insert all fasteners in the same direction.**
For aesthetic purposes, insert all the fasteners in the same direction unless specified (in text or illustrations) to do otherwise.
- **Insert all fasteners with your fingers.**
Use your fingers to properly align and thread the fasteners before wrench tightening. This helps alleviate cross-threading. Do not fully wrench tighten fasteners until instructed to do so.

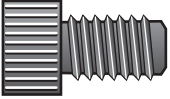
***Important:** When wrench-tightened, the head of the fastener should be flush with the product. If it is not, cross-threading has occurred. Do not attempt to rework the assembly as more damage to the equipment will occur. Call Customer Support. Refer to Obtaining Service.*

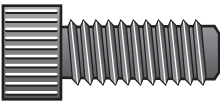
Hardware Kit (not to scale)

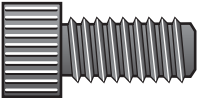
Fasteners		Quantity
	(A) Socket head screw (2 1/4-inch)	4
	(B) Barrel spacer	4
	(C) Socket head screw (3/4-inch)	10
	(D) Washer (5/16-inch x .562 OD)	16
	(E) Socket head screws (1 1/4-inch)	2
	(F) Washer (5/16-inch x .688 OD)	4
	(G) Socket head screw (1-inch)	4

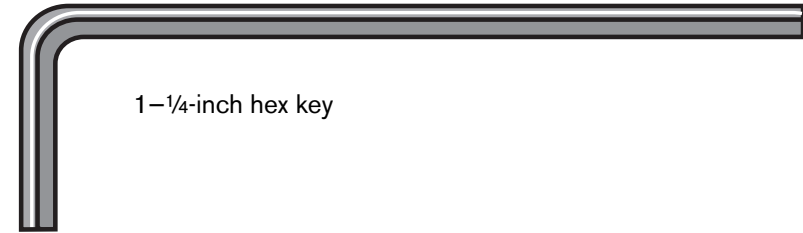

1-1/4-inch hex key

Assembly Steps

- 1** Use a 1/4-inch hex key and 1/2-inch box end wrench to remove the four shipping fasteners on the front panel. Discard the fasteners.

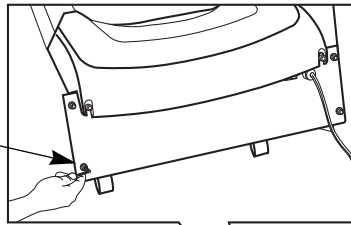

- 2** Unwrap the cable and feed it through the right side upright. Tape the cable along the front edge of the upright.

CAUTION: Before attaching the display console, make sure the cable is taped along the front edge of the upright.

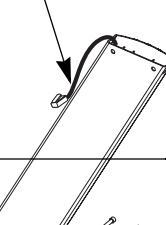

- 3** Place the right side upright into the base frame side bracket. Secure the upright to the front panel using two socket head screws (C). Secure the upright to the side bracket using two socket head screws (A), two washers (D), and two barrel spacers (B). Wrench tighten.

Important: Do not stretch, crimp, or damage the cable. Cables damaged by improper installation will not be covered by the Precor Limited Warranty.

- 4** Place the left side upright into the base frame side bracket. Secure the upright to the front panel using two socket head screws (C). Secure the upright to the side bracket using two socket head screws (A), two washers (D), and two barrel spacers (B). Wrench tighten.

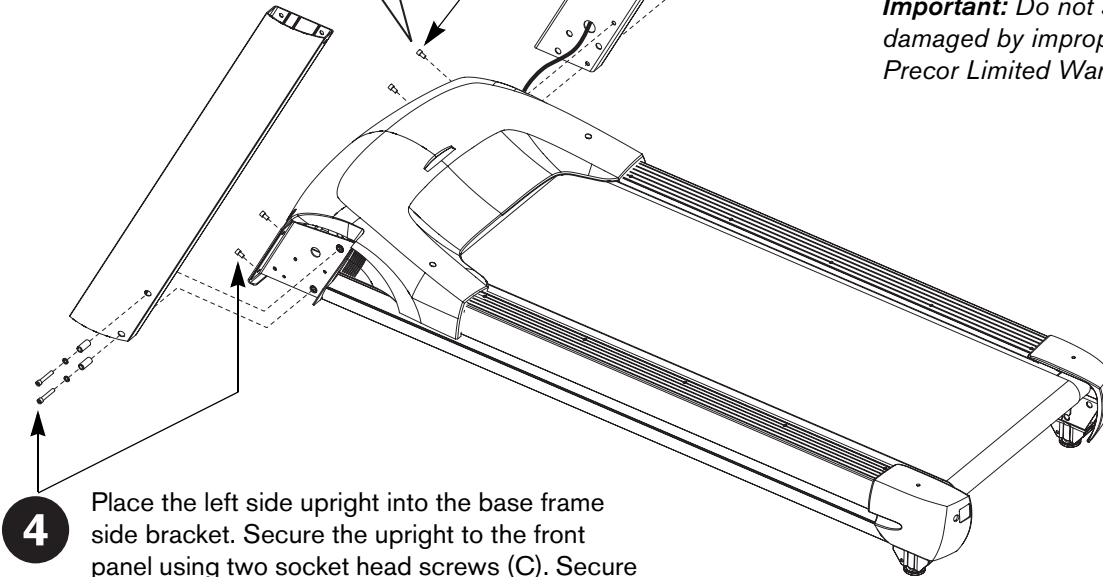

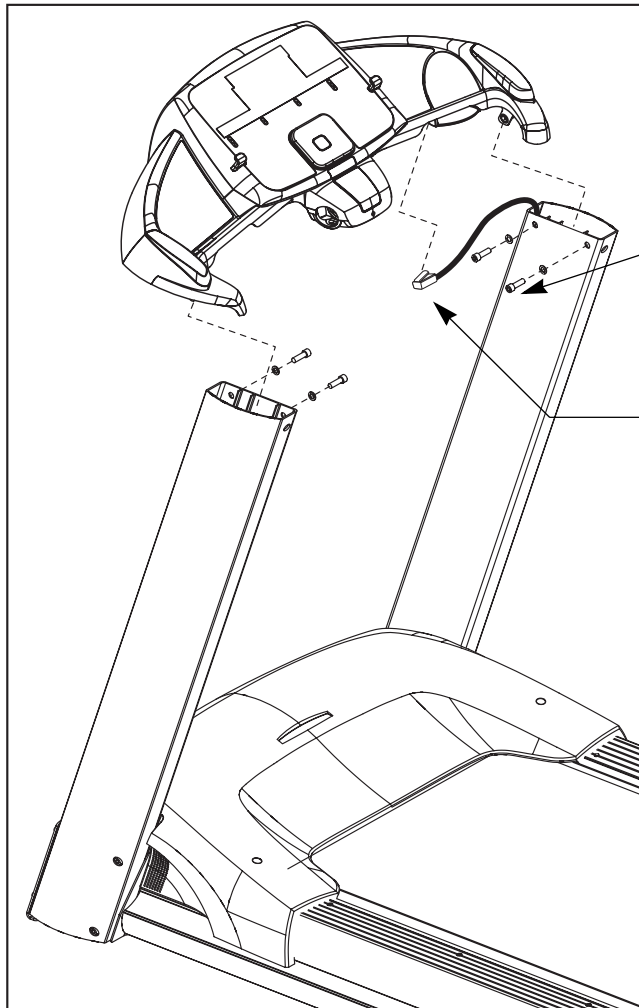

5 Attach the display console using four socket head screws (G) and four washers (D). Align the mounting holes and insert all four fasteners with your fingers. Tighten the fasteners on one upright before performing the same step on the opposite upright. Push down on the edge of the display console to close the gap between the console and the upright and then wrench tighten the fasteners.

6 Hold the cable while you remove the tape. Make sure the cable is not crimped or pinched by the display console or its mounting bracket. Connect the cable to its receptacle on the underside of the display console. Place the loose cable into the support clip. Slide any excess cable into the upright.

7 CAUTION: Do not stand on the treadmill while raising the incline.

To install the handrails, raise the incline.

a. Plug the treadmill into a power outlet. Locate the I/O power switch on the front panel and turn the unit ON.

***Important:** The treadmill requires a dedicated, grounded circuit. A 20-amp circuit is recommended. Refer to Grounding Instructions in the owner's manual.*

b. Stand beside the treadmill and press QUICKSTART. If you are prompted for a password, press INCLINE ▼, SPEED ▼, SPEED ▲.

c. When the running belt begins moving, press the INCLINE ▲ key until the display shows an incline of 15.

d. When the lift stops moving, press the red STOP button, and then turn the treadmill OFF.

8

Use the 1/4-inch hex key to remove the four handrail clamp screws. Set the lower handrail clamp and fasteners aside.

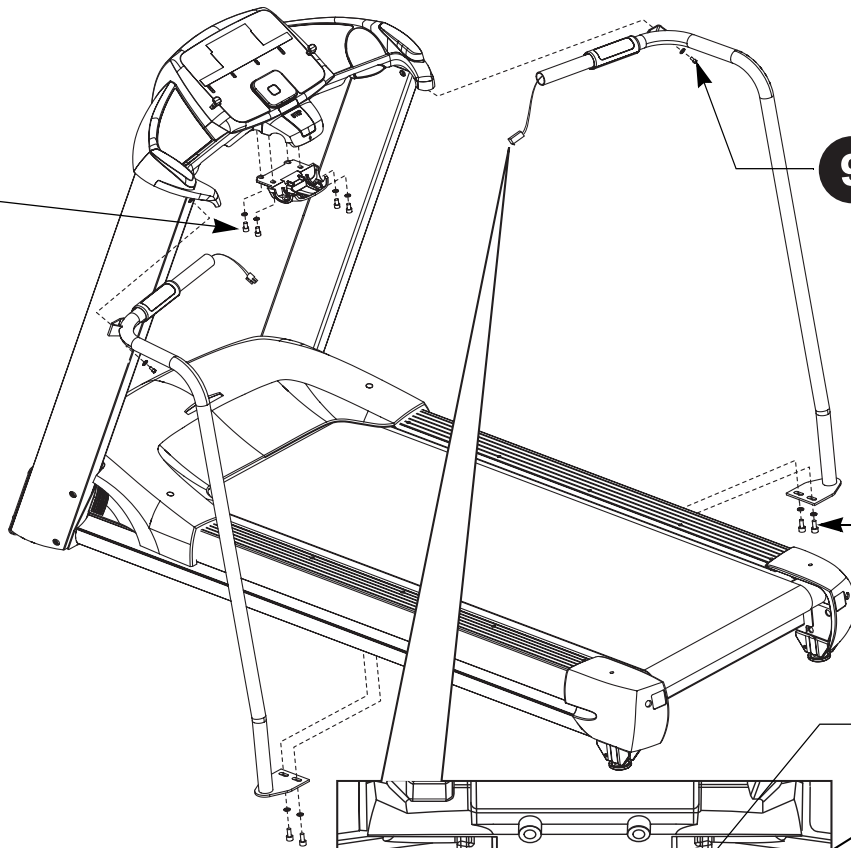

9

Slide the ends of the handrails toward the center handrail clamp and secure them to each side bracket using two socket head screws (C) and two washers (F). Make sure the black foam on the handrail does not cover or interfere with the handrail clamp mounting holes.

10

Attach the lower portion of the handrails to the side rails using four socket head screws (C) and four washers (D). Refer to the note above.

11

Heart rate cables protrude from the ends of both handrails. Slide the end of each cable into its receptacle. Carefully place excess cable inside the recessed area in the display console.

Important: The cable receptacles mirror the connectors so that they cannot be improperly installed. Do not force a connection! Take your time and look for the tabs on the connectors.

CAUTION: Do not place the excess cable in the handrails. The handrail clamp fasteners can damage the cable.

12

Make sure the excess heart rate cables are not impeding the function of the safety switch. Pull on the safety lanyard. If the red STOP button depresses and you hear a clicking sound, the safety switch is working properly.

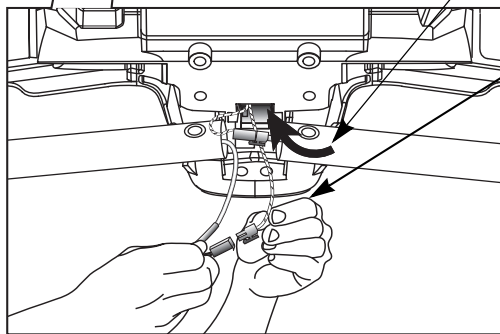

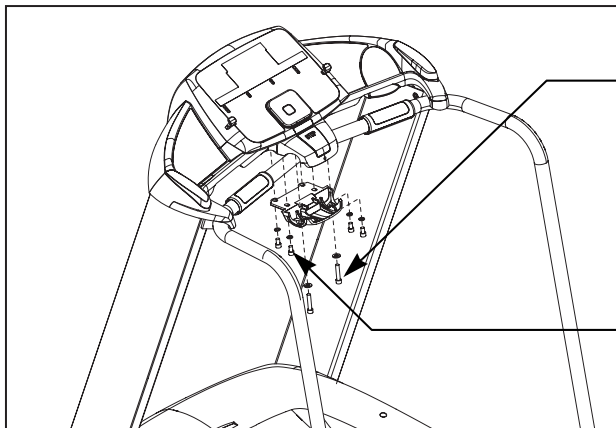

13

Replace the lower handrail clamp and secure the handrails to the clamp using two socket head screws (E) and two washers (F).

14

Replace the four lower handrail clamp fasteners removed in step 8. To reduce gaps between the upper and lower portions, squeeze the clamp together while you wrench tighten all six fasteners.

15

Test the heart rate feature.

a. Turn the unit ON. The Precor banner appears in the display.

CAUTION: When testing the heart rate feature, stand to the side of the treadmill until the lift stops moving and the incline returns to zero.

b. Face the display and straddle the running belt.

c. Place both hands on the touch-sensitive handrail grips. The letters **Hr** begin to blink in the Heart Rate display indicating that a signal is being transmitted. A heart rate appears within 15 seconds if you continue holding both grips.

d. When the test is completed, turn the treadmill OFF and continue with step 16.

Note: If the blinking **Hr** does not appear, turn the unit OFF. Recheck the cable connections beneath the handrail clamp and ask someone else to test the heart rate feature.

16

Tighten the following mounting screws.

a. Wrench tighten the two upper handrail side screws. Refer to step 9.

b. Wrench tighten the four side rail screws at the base of the handrails. Refer to step 10.

17

Level the unit by inserting the 1/4-inch hex key, as shown. Make sure the key is fully engaged and then turn it to raise or lower the rear portion of the treadmill.

Important: Do not raise or lower the unit beyond 2 centimeters (3/4 inch). Check the level of the unit after each adjustment. Place a bubble level across the rear deck for precise measurements.

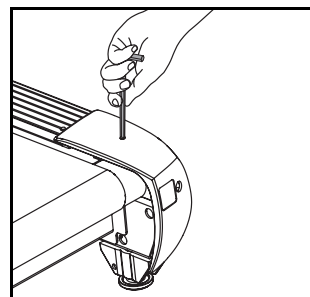

18

Check the alignment and adjust the running belt. For instructions, refer to *Checking the Alignment and Adjusting the Running Belt*.

Checking the Alignment and Adjusting the Running Belt

Proper belt alignment allows the belt to remain centered and ensures smooth operation. Realigning the belt takes a few simple adjustments. If you are unsure about this procedure, call Precor Customer Support. Refer to *Obtaining Service*.

To check the alignment:

1. The treadmill has adjustable rear feet. Make sure that the running surface is level before aligning or adjusting the running belt. Refer to step 17.
2. Turn the unit ON.
3. Stand beside the treadmill and press QUICKSTART.
4. If you are prompted for a password, press INCLINE ▼, SPEED ▼, SPEED ▲. The running belt starts automatically after the 3-second countdown appears on the display.
5. Press the SPEED ▲ key until the display shows a speed of 3 mph (5 kph).
6. Walk around to the rear of the unit and observe the belt for a few minutes. The belt should run centered along the running bed. If the belt drifts off center, you will need to make adjustments.
Important: *If the belt needs alignment, make the adjustments immediately after turning the treadmill OFF. Failure to do so may cause the belt to tear or fray, which is not covered by the Precor Limited Warranty.*
7. To stop the running belt, press the red STOP button.
8. Turn the treadmill OFF.

To adjust the running belt:

CAUTION: To ensure your safety, turn OFF (O) the treadmill before making any adjustments.

1. Locate the right belt adjustment bolt in the rear end cap of the treadmill. (To determine left and right, stand at the rear of the treadmill and face the display.) Make all belt adjustments on the **right rear corner bolt** using the 1/4-inch hex key.
 - If the belt is off center to the LEFT, turn the adjusting bolt 1/4 turn *counterclockwise*, which moves the running belt to the right.
 - If the belt tracks off center to the RIGHT, turn the bolt 1/4 turn *clockwise*; this moves the belt to the left.**Important:** *Do not turn the adjusting bolt more than 1/4 turn at a time. Overtightening the bolt can damage the treadmill.*
2. Recheck the alignment of the running belt.

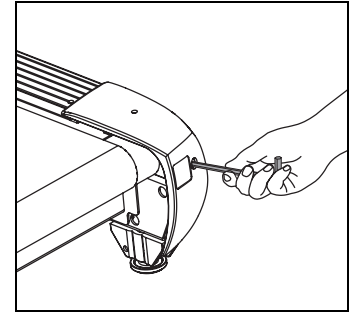

Notes:



Precor Incorporated
20031 142nd Avenue NE
P.O. Box 7202
Woodinville, WA USA 98072-4002

©2005 Precor Incorporated
www.precor.com
M9.3xi Online AG 48829-401
14 September 2005

Free Manuals Download Website

<http://myh66.com>

<http://usermanuals.us>

<http://www.somanuals.com>

<http://www.4manuals.cc>

<http://www.manual-lib.com>

<http://www.404manual.com>

<http://www.luxmanual.com>

<http://aubethermostatmanual.com>

Golf course search by state

<http://golfingnear.com>

Email search by domain

<http://emailbydomain.com>

Auto manuals search

<http://auto.somanuals.com>

TV manuals search

<http://tv.somanuals.com>