

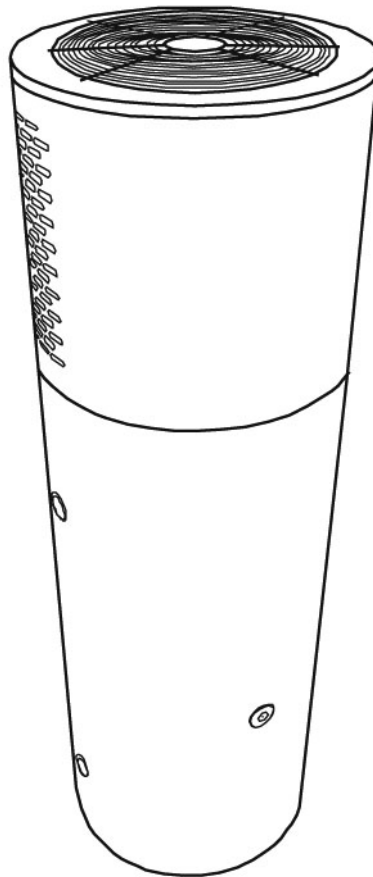

Premier Heat Pumps



Water Heater & Chiller User Manual

Essential Notes on Acceptance and Installation of the Premier Heat Pumps (PHP) Water Heater and Chiller







- 1) **Delivery:** After removing the transport packaging please check the PHP Water Heater for any possible damage attributable to shipping. Any degradation related to transport should be advised within 48 hours.
- 2) **Important:** Please fully read the installation instructions prior to installation. Installation should only be carried out by suitably qualified electrician and/or authorised installer. These instructions should be retained for future reference.
- 3) **Standards of Installation:** The installation must be carried out in accordance with the applicable local safety and installation standards. The installation must be in accordance with the manufacturer's installation instructions; a person qualified in the installation of Premier Heat Pump Hot Water Cylinders. Incorrect installation can cause injury to persons or damage to the unit. The supplier cannot be responsible for incorrect installation or any resulting damage or injury.
- 4) **Intended Operation:** This heat pump is intended to be used as a domestic hot water cylinder. Any other use or application will void the warranty.
- 5) **Breakdown:** In the unlikely event of failure, contact the installer. There are no operator serviceable parts and all repairs should be undertaken by a refrigeration engineer or other authorised technician.
- 6) **Resale:** In the event of resale to a third party, it is imperative that all manuals and warning and cautions be made available to the new owner.

Content

ESSENTIAL NOTES ON ACCEPTANCE AND INSTALLATION OF THE PREMIER HEAT PUMPS (PHP) WATER HEATER AND CHILLER	2
Content	3
1 - Warnings and Cautions	4
! Caution !	5
2 - Description of the Heat Pump	6
2-1 Outside	6
2-2 Inside	7
2-3 Dimensional and Technical Characteristics	8
3 - Installation	9
3-1 Locating the Unit	9
Caution	9
3-2 Water connections	10
3-3 Electrical Connections	11
3-4 How the reversible heat pump operates	12
3-5 Display and Control Screen Description	13
4 - Use in Standard Mode	14
5 - Instructions for the Installer	16
5-1 Unit controller and parameters	16
5-2 Defrost operation:	16
5-3 Fault Codes and Fault Descriptions	17
6 - Maintenance Instructions	17
7 - Gas Flow Diagram	18
8 - Wiring Diagram	20
9 - Problems and Solutions	21

1 - Warnings and Cautions

	Incorrect handling has the potential to cause serious damage or injury to the unit, installer or operator. The unit should be installed by a professional and operated in accordance with this user manual
---	--

	Do not
	Attention
	Confirm electrical connection
	Disconnect power supply
	Do not stand on or place objects on the unit
	Do Not Touch

Unit must be installed in accordance with AS/NZS 3500.4 : NZBC G12

Complies with CE and New Zealand Safety Standards including; AS/NZS 60335
AS/NZS 4692 : AS/NZ 2712

Specifications may be amended from time to time without prior notice.

! Caution !

Do not climb on the unit or try to move it once installed.	Keep out of reach of children. Do not allow them to play on or near the unit.
Do not place foreign objects or fingers into the air inlet/outlet. The fan runs at high speed and can cause serious injury. Do not operate the unit without the safety grill in place.	Important: Ensure that the plug remains clean, free from moisture, foreign objects and dirt. Ensure that the plug is properly inserted or hard wired by a qualified electrician.
If the unit operates abnormally, stop the unit by firstly switching it off and then unplug the unit. For example, if there is a strange smell or abnormal noise coming from the unit.	Do not clean the appliance with water. Water will go into the unit and will destroy the insulation.
Turn the unit off at the wall before unplugging the unit. Do not disconnect the power while the unit is running.	Do not pull on the cable to unplug the unit, damage to the plug and cable could occur
Do not touch the plug with wet hands, as electric shock can occur.	Ensure that the power to the heat pump is disconnected before removing leaves, particles or other foreign objects from the air inlet vanes.

Verify the network specifications, with the unit data recorded on the heat pump prior to installation.

Any additional disinfectant systems, such as chemical or electrolysis are not recommended for use with this hot water heat pump. The pump **MUST** be installed prior to these systems.

For optimal operation of the heat pump, the following maximum values apply:

- A. Use of free chlorine : max : 2.6mg/l
- B. Total bromine : max : 5.6mg/l
- C. pH : between 6.5 and 8.0

2 - Description of the Heat Pump

2-1 Outside

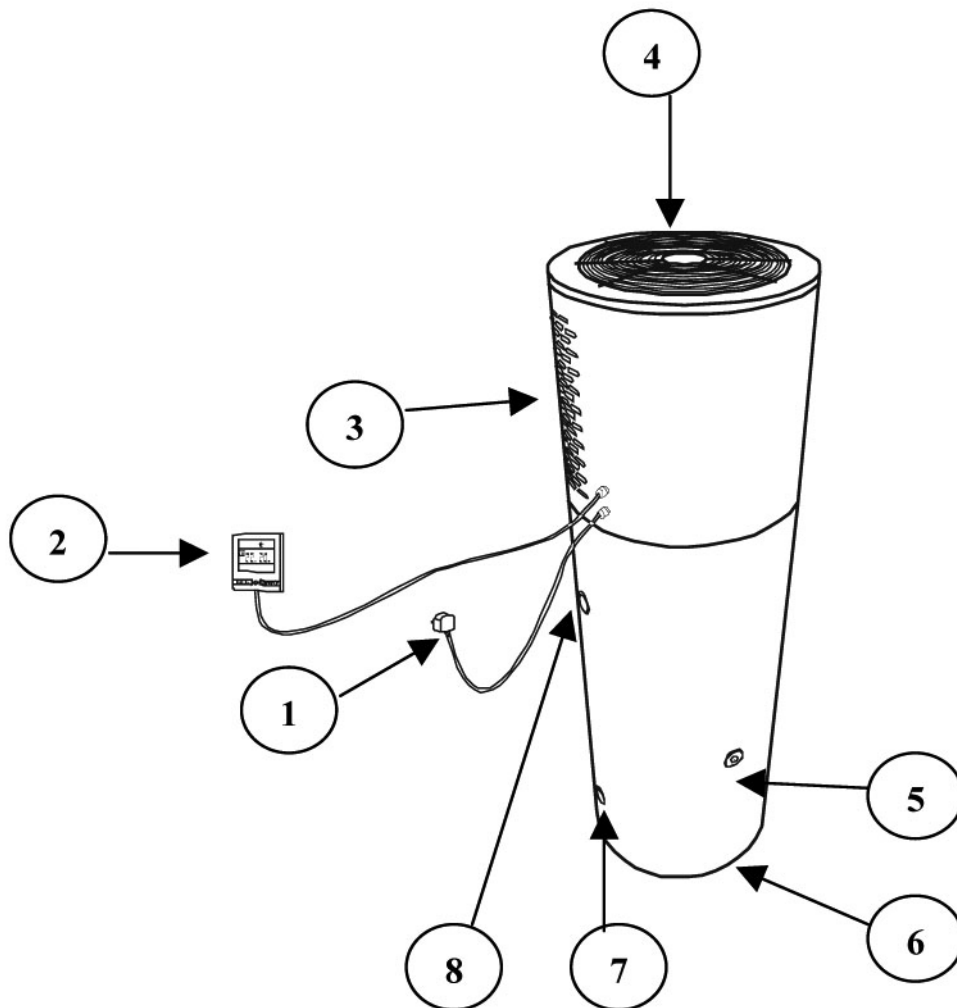

1	Power Plug
2	Control Panel
3	Air Inlet
4	Air Outlet
5	Temperature Sensor
6	Drainage
7	Cold Water Inlet
8	Hot Water Outlet

2-2 Inside

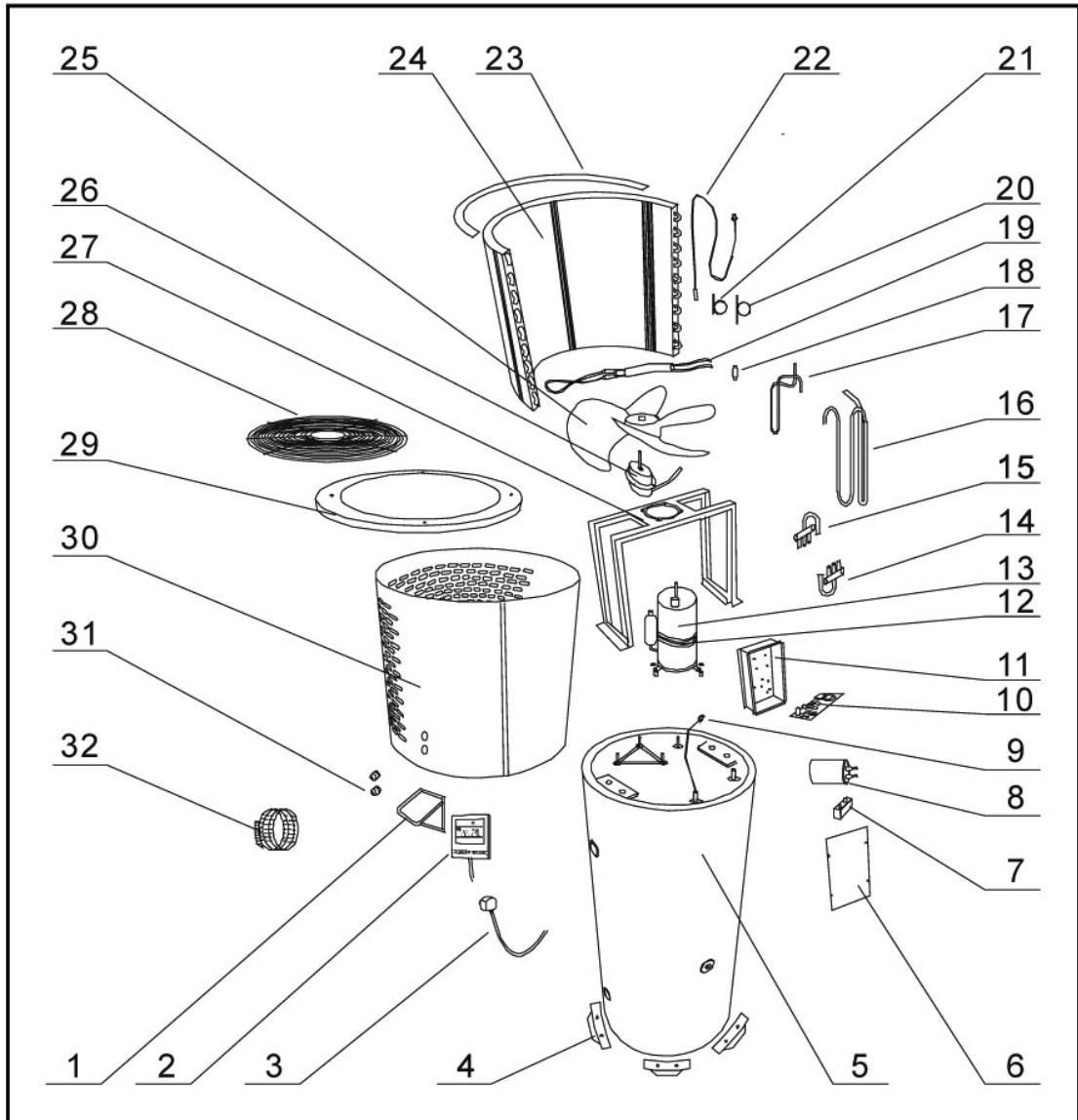

1	Control Panel Cover	15	Four-way Valve 2	29	Top Cover Plate
2	Control Panel	16	Gas Returning Pipe	30	Air Inlet Frame
3	Power Plug	17	Exhaust Pipe	31	Clip of Power Cable
4	Plastic Base	18	Filter	32	Drainage Pipe
5	Water Tank	19	Heat Exchanger Heater	33	
6	Cover for Electrical Box	20	Auxiliary Capillary	34	
7	Motor Capacitor	21	Capillary	35	
8	Compressor Capacitor	22	Defrost Sensor	36	
9	Temperature Sensor	23	Condenser Top Poly-foam	37	
10	Circuit Board	24	Heat Exchanger	38	
11	Electrical Box	25	Fan	39	
12	Compressor Heater	26	Fan Motor	40	
13	Compressor	27	Motor Bracket	41	
14	Four-way Valve 1	28	Rear Net	42	

2-3 Dimensional and Technical Characteristics

Model Number	PHP HWC-150	PHP HWC-200	PHP HWC-260
Heating Capacity (KW)	3.2	5.8	6.5
Cooling Capacity (KW)	2.6	4.9	5.7
Nominal Power Input (KW)	0.9	1.48	1.8
Nominal Current (A)	4.2	6.8	8.4
Maximum Current (A)	6.3	8.4	12.6
Compressor Quantity	1	1	1
Fan Quantity	1	1	1
Noise dB(A)	47	47	49
Temperature of output water (°C)	10-55	10-55	10-55
Unit Net Dimension (D X H)	Φ470 X 1965	Φ555X 1780	Φ555X 2113
Unit Shipping Dimension (L/W/H)	555/530/2085	630/610/1900	630/610/2233
Net weight / Gross weight (kg)	46/49	56/60	70/74
Water Connection (Inch)	1	1	1
Capacity of the water tank (L)	150	200	260
Power Supply (V/Ph/Hz)	220-240/1/50	220-240/1/50	220-240/1/50
Ambient Temperature (°C)	-7 to +40	-7 to +40	-7 to +40
Electrical Control Way	Mini Computer Intelligent Control		
Controller	LCD Display		
Wire Control	Yes		
Heating and Cooling Water	Yes		
Auto-defrosting Function	Yes		
Maximum input water pressure	1550 kpa		

* According to climactic conditions

NB: Product sound measurement is tested in the factory before shipping. "Dimensions and Technical Characteristics" data table shown above is accurate at the time of publication. Premier Heat Pumps reserves the right to amend the unit specifications without prior notice. Product code plate affixed to the individual unit reflects the specifications of the individual unit.

3 - Installation

3-1 Locating the Unit

It is important to install the hot water heat pump in accordance with the following instructions. Water and electrical connections must be carried out by a suitably qualified tradesman or installer

- The appliance must be installed outside.
- The appliance must be mounted on its anti-vibratory studs, positioned on a substantial platform (concrete or steel pad). The platform must have sufficient height to prevent water entering the bottom of the unit and also allow the condensate to drain freely from the connection at the bottom of the unit
- Vegetation and other obstacles must be kept clear of the unit, in accordance with the minimum distances detailed below

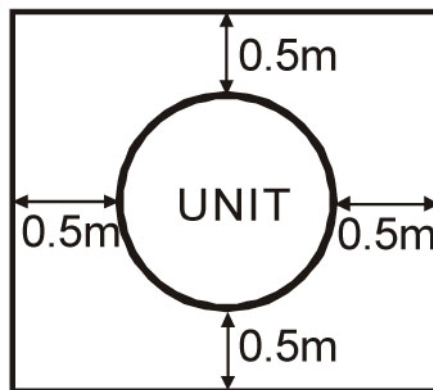

- The unit should be positioned so that the exhaust does not blow towards windows or doorways.
- There must be a minimum clear distance above the unit of 1.5m
- The stability bracket on the back of unit must be securely fixed to a post or wall so as to position the unit vertically and prevent any movement of the unit.
- Connect the drain pipe to the condensate outlet and direct it away from the unit.

Caution

- Do not install the appliance in an area where dirt, mud, mown grass or other foreign objects could affect airflow around the unit causing damage or operational issues.
- Shelter the unit from prevailing winds
- Shelter the unit from falls of snow or heavy rain fall
- Prevent children from playing on or around the unit

3-2 Water connections

Please refer to the diagram below:

- 1) Connect the hot water in pipe (hot water supply pipe) to the outlet port on the hot water cylinder. Pay attention to heat preservation and ensure appropriate thermal insulation of the pipe work. It is important that the unused hot water outlet port be properly capped. The plastic transport caps are not suitable for this function.
- 2) Install a water filter (where necessary) and one-way valve in the tap water (inlet water pipe) and then connect the tap water pipe (inlet water pipe) to the inlet port on the tank.
- 3) Fill the tank with water. Open the tap water (inlet water) in-valve allowing the tank to fill with water; Meanwhile, open the hot water out-valve, until the water spills over from the hot water out valve. Once this happens the tank is full of water. Close the tap water (inlet water) in-valve, check and ensure that there is no leakage in the system. Re open all valves.

Attention: Be sure the tank is full of water before it is switched on.
Warning: The inlet and outlet plastic caps are for transport only. Any unused inlet or outlet ports must be blanked off properly using compliant metal pipe caps.

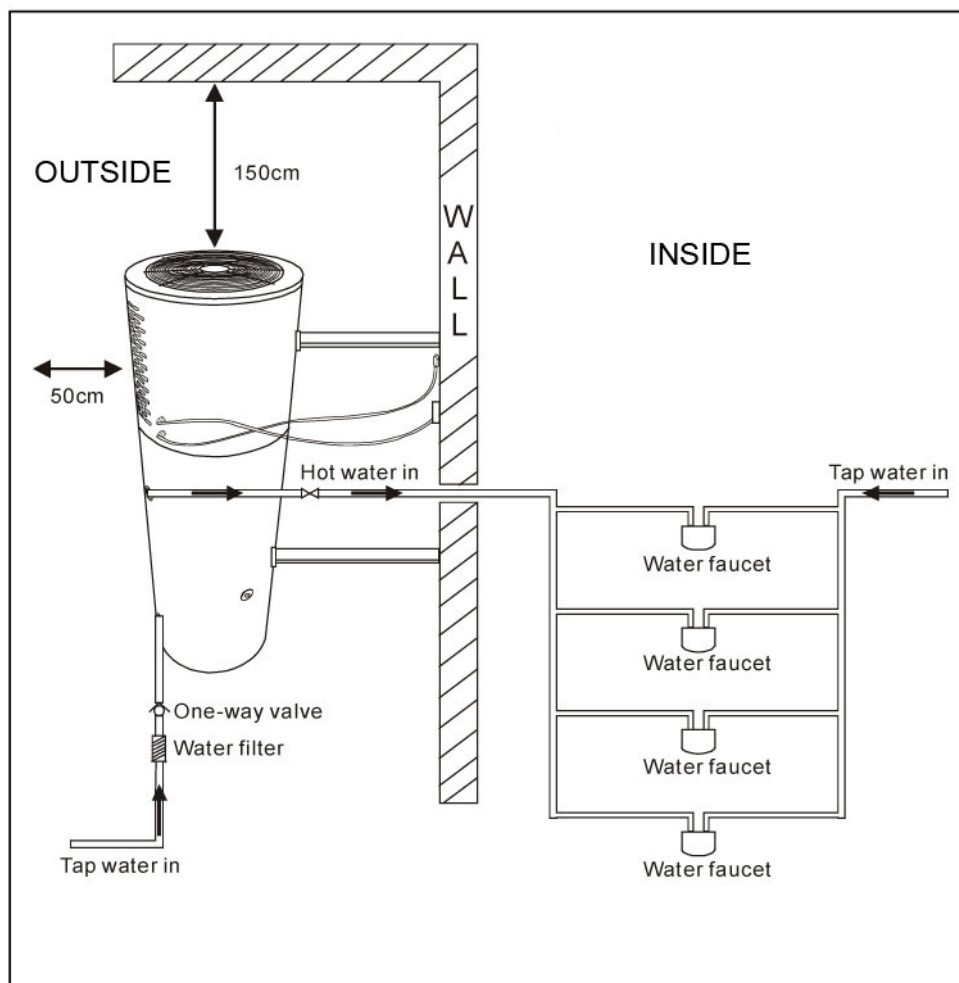

3-3 Electrical Connections

CAUTION: before connecting the appliance, make sure that the supply power line is disconnected from the network.

General Power Supply Characteristics

- Neutral mode TT and TN.S; the circuit of the heat pump must be connected to the earth circuit

Connections

- The electric installation must be carried out by a qualified professional or electrician
- The power supply of the heat pump must come from an independent circuit and have the appropriate circuit protection.
- The controller must be installed on an indoor wall in an easily accessible area.

Electrical Protection

- Circuit breaker curves D or standard fuse protection Am, gauged with 16A
- Differential protection of 30mA

Connection to an Electrical Plug

- The heat pump comes packaged with an electric cable and plug.
- The plug must be safe, protected from rain and water and the condition checked regularly

Before starting the heat pump hot water cylinder, it is important to fully read this manual and understand the operation and the settings.

3-4 How the reversible heat pump operates

By using the free energy contained in the ambient air, the heat pump enables the heating of the water in a very economical way. Your heat pump is a heat machine that can transfer the heat from a low temperature area (ambient air) to a higher temperature area.

How the pump operates in heating mode:

The heat of the air is absorbed by the cold, liquid refrigerant, through the evaporator (radiator with wings), the refrigerant is vaporised. Then the compressor increases the pressure and the temperature, and sends it into the condenser (exchanger) where it loses its heat by transferring it to the water. The refrigerant then returns to the liquid state, it loses its pressure and cools again, flowing into the pressure reducer before returning to the evaporator for a new cycle.

Operating cooling mode or defrosting mode:

A 4 way valve enables a reverse cycle of the refrigerant; this fluid liquid is vaporized in the exchanger (the evaporator) by taking the heat out of the water, which then passes into the compressor that heats it and in turn sends it to the radiator (the condenser) where the refrigerant returns to it's liquid state.

Note: Single water heater without cooling water mode; Single water chiller without heating water mode and defrosting mode.

3-5 Display and Control Screen Description

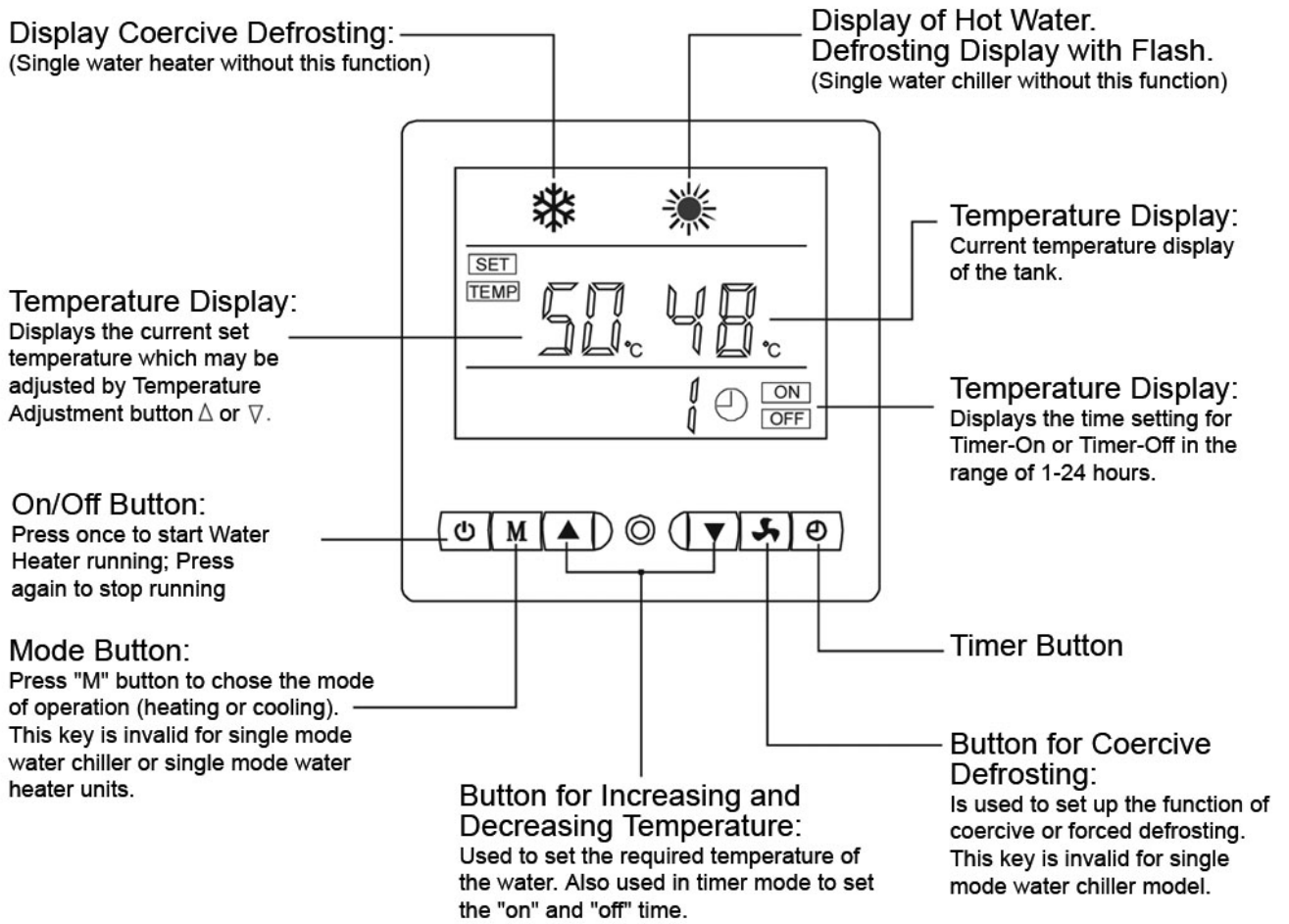

4 - Use in Standard Mode



Starting operation

Press the power button " " when the unit has received the signal it gives out two 'beep' tones. The operation light switches on and the heat pump water heater starts operation. The compressor will restart after 3 minutes to protect the system if the interval is shorter than 3 minutes from the last shut down to the present switch on.



Mode Selection

Press the 'M' button to choose the mode of heating and cooling (this key is invalid for the single water chiller or single water heater)

Temperature Setting Selection

- 1) Press "Temperature Adjustment Button  to set the temperature 1 degree higher
- 2) Press "Temperature Adjustment Button  to set the temperature 1 degree higher
- 3) Temperature range is set in heating mode: 45°C to + 55°C (Single water chiller is without this function)
- 4) Temperature range is set in cooling mode: 10°C to + 35°C (Single water heater is without this function)

Timer Switch On

- 1) When the heater is off press the " " timer-on button to set time for the timer-on switch. Press the button once to change the time interval of 1 hour in a cyclic manner of 1,2,...24,1,2 (The display shows the previous time as the starting time of the present setting)
- 2) When it reaches the switch-on time, the heat pump water heater will operate in the preset time mode.
- 3) Press the timer-on " " button again, and the set up is cancelled.
- 4) If the on/off " " button is pressed while the unit is under the timer on setting, the unit will start immediately. The timer setting is at that point cancelled.

Timer-Off Switch

- 1) When the heater is on, press the " " timer-on button to set time for the timer-on switch. Press the button once to change the time interval of 1 hour in a cyclic manner of 1,2,...24,1,2 (The display shows the previous time as the starting time of the present setting)

- 2) When it reaches the switch-off time, the heat pump water heater will automatically shut down.
- 3) Press the timer-on "🕒" button again, and the set up is cancelled.
- 4) If the on/off "🔌" button is pressed while the unit is under the timer-off setting, the unit will shut down immediately. The timer setting is cancelled.
- 5) Timer-On and Timer-Off cannot be set at the same time.

Coercive Defrosting

- 1) Press the "🔌" button, the heater will go into the defrost mode.
- 2) After 3 minutes, when the units coil temperature has reached 10°C or the time of defrost reaches 8 minutes, defrosting is stopped.
- 3) After exiting the defrost mode, the heater will stop operation for 3 minutes, then it will run in the mode before defrosting. (This key is invalid for single mode water chiller)

5 - Instructions for the Installer

The installer must read the following and provide instructions to the purchaser.

5-1 Unit controller and parameters

The Heat Pump is Equipped with 2 Control Devices:

- A defrost temperature probe, located on the evaporator, starts the defrost sequence.
- A thermal probe located on the exchanger ensures the cut of the heat pump when the temperature of the water reaches the temperature required.
- The meaning of the code name

T1: water temperature

T2: ambient temperature

T3: exhaust temperature from compressor

T4: coil temperature in outdoor heat exchanger

TC: water temperature setting

Control Function:

- 1) TC can be set between 10°C-35°C in cooling mode. Original TC is 18°C. When $T1 \leq TC - 1^\circ\text{C}$, Compressor and fan motor stop; When $T1 \geq TC + 1^\circ\text{C}$, Compressor and fan motor start.
- 2) TC can be set between 45°C -60°C in heating mode. Original TC is 50°C. When $T1 \leq TC - 1^\circ\text{C}$, Compressor and fan motor start; When $T1 \geq TC + 1^\circ\text{C}$, Compressor and fan motor stop. When compressor is running, if $T2 \leq 12^\circ\text{C}$, the four way valve2 on; if $T2 \geq 12^\circ\text{C}$, the four way valve2 off.

5-2 Defrost operation:

1) Defrost:

The system begins to defrost if the following three terms are met in the same time:

- a) $T4 \leq -5^\circ\text{C}$ lasts for a while;
- b) compressor runs continuously for more than 5 minutes
- c) Compressor runs accumulative total for 45 minutes

While the system begins to defrost, compressor and fan motor stop first and four way valve1 is on after 1 minute and begins to work. The compressor restarts after it has stopped for 3 minutes. If the sensor for T4 is damaged, the system begins to defrost, after the compressor has run continuously for 45

minutes.

2) Parameters for Exiting Defrost Mode:

- When defrosting time reach 3 minutes and T4 reaches 10°C or defrosting time reaches 8 minutes, defrost exits and starts heating water mode. While defrost is exiting, after compressor and fan motor have stopped for 1 minute, the four way valve1 is turned off.
- The Compressor will restart after it stops for 3 minutes, and the system will run the same mode as before defrosting.

5-3 Fault Codes and Fault Descriptions

Failure Code:

E1: sensor for T1 (water temperature) failure

E2: sensor for T2 (ambient temperature) failure

E3: sensor for T3 (exhaust temperature from compressor) failure

E4: sensor for T4 (coil temperature in condenser) failure

E5: Compressor stops three times in 24 hours because the current is too high.

E6: While heating water, there is three times of T3≥100°C in 24 hours.

E7: There is electrical leakage in the compressor or outdoor motor or four-way valve

Recommendation: Contact the installer or service agent

6 - Maintenance Instructions

The following operational maintenance must be done by a qualified person each year:

- Clean the back evaporator with a delicate brush and water jet without any pressure (karcher prohibited)
- Check the mandatory labelling and the operation of the unit
- Check the safety measures
- Check the pressure of the refrigerating gas
- Clean the electric box and control the connections
- Check the electrical connections

7 - Gas Flow Diagram

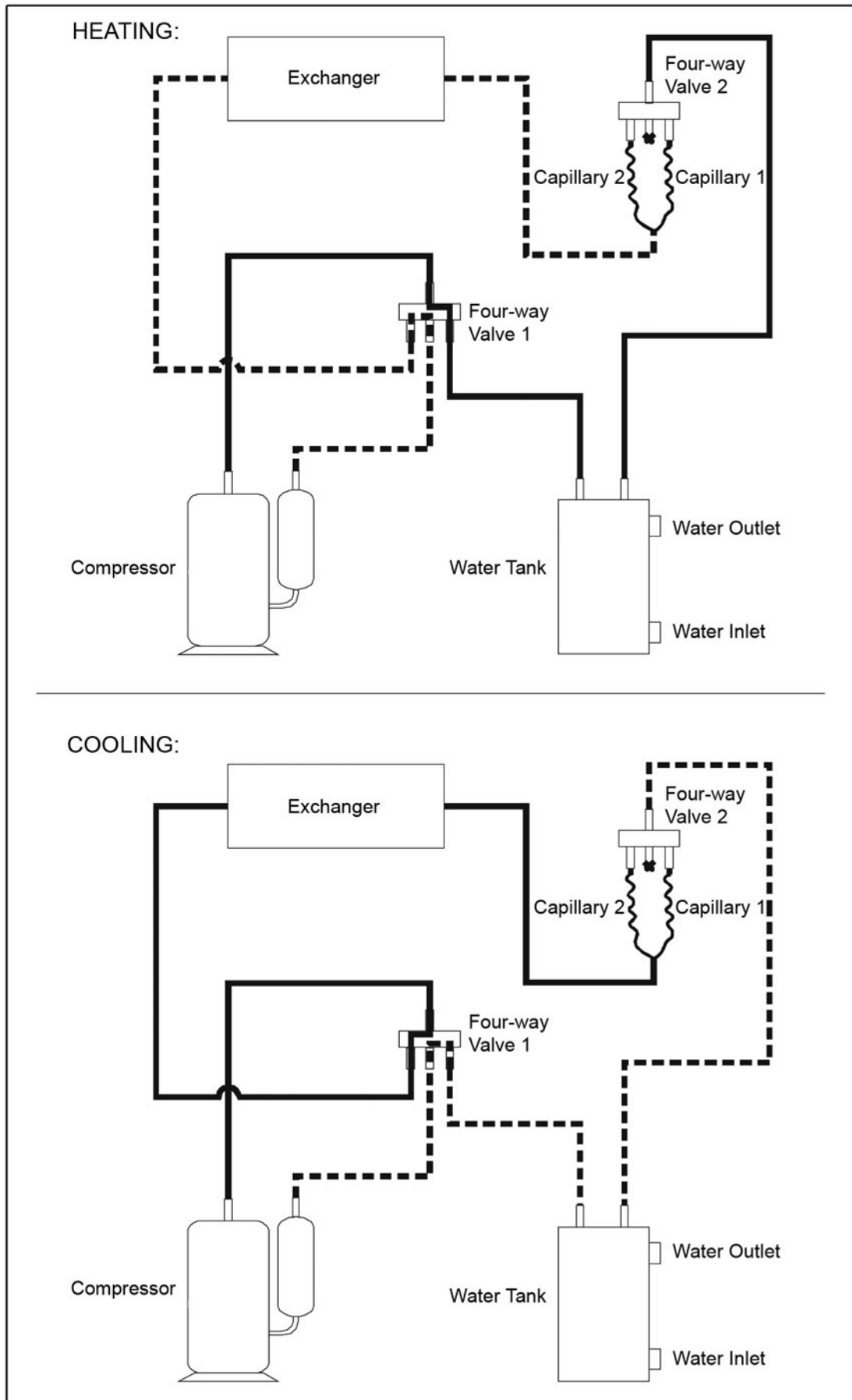

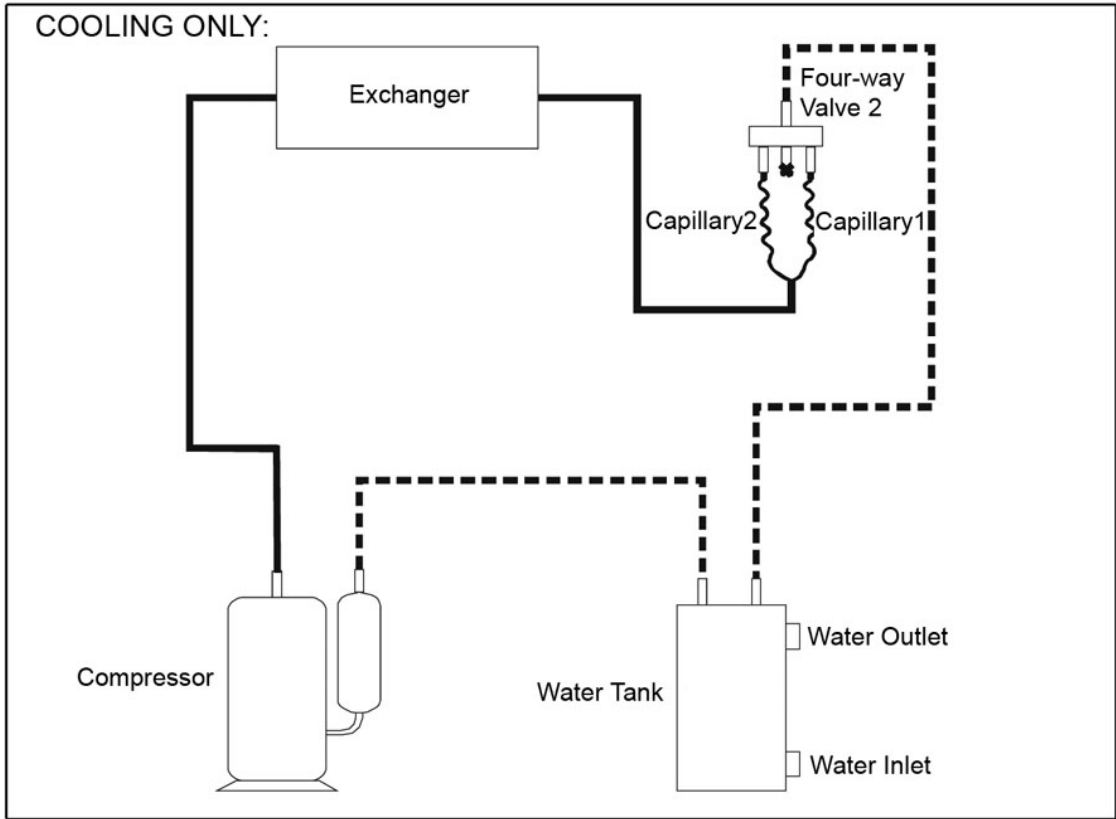

8 - Wiring Diagram

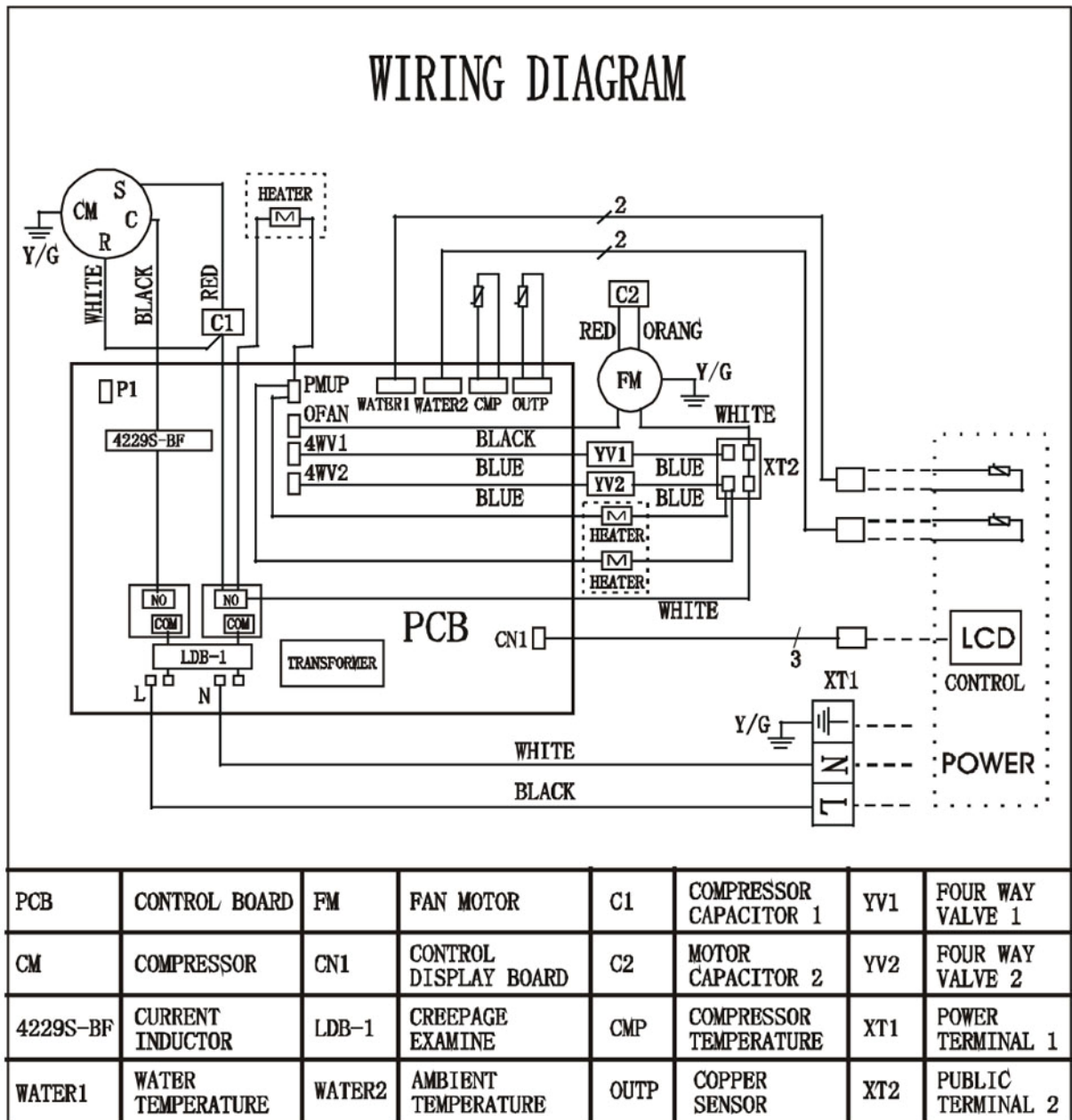

9 - Problems and Solutions

Please refer to the table below for the most common problems. These can often be solved by reading the table below. If nothing corresponds to the list, or if the solutions applied do not solve the problem, contact your retailer

Problem	Observation	Probable Cause	Explanation/Solution
The heat pump does not start	Blank display	No electrical feed or power supply	Check the plug and electrical connection. Check the line circuit breaker
The heat pump does not start	Screen on	Low voltage	Find out reason and repair
The heat pump starts and stops within a few minutes		Refrigerant circuit is damaged	Check leakage, charge refrigerant with correct amount. Change compressor repair damaged refrigerant circuit
The temperature of the water heater increases very slowly	The heat pump works		Water temperature and ambient temperature too low Water amount used continuously too large.
Water is running under the heat pump	Water condensate come from the condenser and is part of normal operation	Attach the plastic conduit to the black plastic outlet and direct the water away from the unit	The condensates are formed in humid conditions on the cooling fins of the evaporator. Install the conduit to direct the water away from the machine
Some frost appears outside, on the wings of the evaporator	The thickness of the frost is thin	Ambient temperature is too low	The frost is entailed by the freezing of the humid air on the wings of the evaporator. It's quite natural and the heat pump is going to defrost. Consider the wintering of the heat pump.
	The thickness of the frost is thick (the blades of the ventilator may rub on the ice much more on the inside)	The de-icing probe or the thermic circuit breaker does not work	Stop the heat pump and call your retailer
The heat pump works but the temperature of the water does not rise (*)	The pressure of the refrigerant shown on the manometer is very low	Loss of refrigerant from the unit	Stop the heat pump and call your retailer or a refrigeration technician
	The pressure of the manometer is right	Breakdown or abnormal wear of the compressor	

Free Manuals Download Website

<http://myh66.com>

<http://usermanuals.us>

<http://www.somanuals.com>

<http://www.4manuals.cc>

<http://www.manual-lib.com>

<http://www.404manual.com>

<http://www.luxmanual.com>

<http://aubethermostatmanual.com>

Golf course search by state

<http://golfingnear.com>

Email search by domain

<http://emailbydomain.com>

Auto manuals search

<http://auto.somanuals.com>

TV manuals search

<http://tv.somanuals.com>