



PTA1 2X15 Watt Stereo Power Amplifier



www.pyleaudio.com

Your New Pyle Pro Amplifier gives you the power and versatility you need in a professional sound system. The amplifier's wide frequency response makes it suitable for amplifying music or vocal program material. It can be used in meeting halls, house, restaurant, schools, stores, or for paging systems.





PTA1 features a PAGER-MIXING function that offers the flexibility of using it at paging or musical events.

Please read this manual thoroughly before you attempt to set up and use the amplifier. It contains a range of installation suggestions as well as instructions to ensure safe usage.

Installed properly, you can expect years of trouble-free service from this product.

TABLE OF CONTENTS

1. Features and Controls
3. Caring for your Pyle Pro Amplifier
5. Limited warranty
6. Specifications

	CAUTION RISK OF ELECTRIC SHOCK DO NOT OPEN		WARNING: To reduce the risk of fire or shock hazard, do not expose this product to rain or moisture
CAUTION: TO REDUCE THE RISK OF ELECTRIC SHOCK, DO NOT REMOVE THE COVER OR BACK. NO USER-SERVICEABLE PARTS INSIDE. REFER SERVICING TO QUALIFIED PERSONNEL.			
	The lightning symbol is intended to alert you to the presence of uninsulated, dangerous voltage within this product enclosure that might be of sufficient magnitude to constitute a risk of electric shock. Do not open the product case.		
	The exclamation symbol is intended to inform you that important operating and maintenance instructions are included in the literature accompanying this product.		

Features and controls

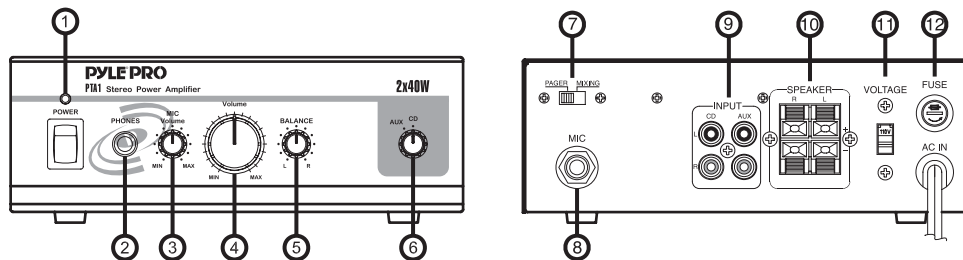

1. Power ON LED Indicator
-Lights to indicate power is turned on.
2. 1/4"PHONE JACK
-Accepts headphones with 1/4" plug.
3. MIC VOLUME CONTROL
-Lets you adjust the volume of connected MIC to the proper setting.
4. MUSIC VOLUME CONTROL
-Lets you adjust the volume of music output from the sources of AUX OR CD. It doesn't affect the volume from MIC.
5. BALANCE CONTROL
-Lets you adjust the sound balance between the left and right amplifier output.
6. AUX/CD INPUT SELECTOR
-Lets you select the desired input music source.
7. SWITCHABLE MIC PAGER AND MIXING MODES
-Set to PAGER, allows a voice to be heard clearly through the microphone by attenuating automatically all the audio input sources. This is good to use when paging the person in office, store, or restaurant.
-Set to MIXING, both of the voices from microphone and

music will be existed at the same time. It is similar like playing at KARAOKE events.

8. 1/4" MIC INPUT JACK

-Lets you connect a microphone with a 1/4" plug.

9. AUX/CD RCA INPUT

-Lets you connect most high-level audio sources such as CD player, tape deck, tuner, camcorder or VCR.

10. SPEAKER L/R TERMINALS

-Lets you easily connect speaker wires directly to the amplifier. Speaker impedance can range from 8 to 4 ohms for the general stereo output. please see the next instruction of using four 8-ohm speakers for stereo mode connection.

11. VOLTAGE SELECTOR

-Lets you select the voltage of AC power input source. The amplifier has selectable input voltage from 110v/60Hz which is the standard in USA and CANADA. You can also switch the input voltage to 230V/50Hz for EUROPEAN operation. Please make sure the switch is in the proper position before operating, otherwise severe damage will result not cover by the warranty. Please also replace the fuse with proper rating in this situation (see the next instruction for the fuse rating).

12. FUSE

-The amplifier uses a fuse for protection against surges and short circuit. If the amplifier suddenly turns off and will not turn on, check the fuse, If necessary, replace it with a 1-amp, 250-volt, fast-acting, 5 x20mm fuse (not supplied).

CARING FOR YOUR PYLE PRO AMPLIFIER

Your Pyle Pro Amplifier is an example of superior design and craftsmanship. The following suggestions will help you care for your amplifier so you can enjoy years of use :

- *Keep the amplifier dry. If it gets wet, wipe immediately.
- *Use the amplifier only in well-ventilated installations.
- *Handle the amplifier away from dust and dirt.
- *Wipe occasionally with a damp cloth to keep it looking new.

Do not use harsh chemical, solvents or detergents!

IMPORTANT

Replacing a fuse

This amplifier requires a fuse with the proper rating for protection from power surges and short circuits. If the amplifier suddenly turns off or will not turn on. the fuse is properly blown.

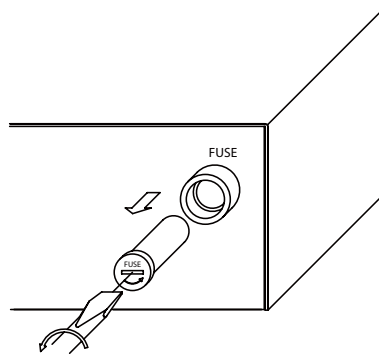

- *Let the amplifier cool down and see if it start again before you assume a fuse needs to be replaced.
- *Unplug the amplifier from the AC outlet.
- *Turn the fuse holder cap and pull out the cap.
- *Remove the old fuse and replace it with an identical one.

CAUTION : Never use a fuse with a higher rating.

Connecting two 4-8 ohm speakers in stereo mode.

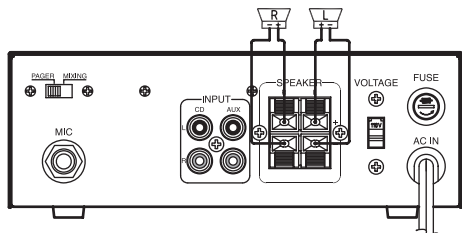

Connecting four 8 ohm speakers in stereo mode.

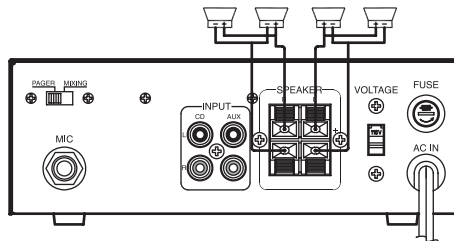

TRUBLE SHOOTING

No power	The fuse might be blown.	Check the amplifier's fuse and replace it if necessary.
No sound	Sound source or speakers not connected properly.	Check all connections.
	MUSIC volume control set to minimum.	Adjust the volume control to desired setting.
	The speaker's wire might be the wrong impedance.	Make sure all connected speakers have the same impedance rating.
	The amplifier might has shut down.	Turn the amplifier off and let it cool. Make sure the amplifier is properly ventilated, and then turn it back on.
Feedback	Microphone or speakers are too close together.	Reposition the microphones and speakers.

Limited warranty

All PYLE PRO products are carefully constructed and tested before shipment. Units purchased in the USA are warranted to be free of defects in material and workmanship for one (1) year from the date of purchase. This warranty is limited to the original retail purchaser of the amplifier.

Should the unit fall due to factory defects in material or workmanship, your unit will be repaired or replaced at the sole discretion of PYLE.

To obtain warranty service, you must first call our Consumer Return Hotline at (718) 236-6948 to obtain a Return Authorization Number.

This R.A # must appear on the outside of your package and on all paperwork relating to your return.

When returning the unit to us for warranty service, it must be carefully packed and shipped, prepaid, to:



R.A.#: _____
PYLE PRO Service Center
1600 63rd Street
Brooklyn, NY 11204

You must also include the following items with your return:

- A copy of your sales receipt or other proof of purchase
- A brief letter, indicating the problem you are experiencing with the product
- Include in your return address, daytime phone number and R.A. number
- Also include a check or money order for \$20.00 for return shipping, handling and insurance, or provide your Visa/ MC number with expiration date.

Our obligation under this warranty is limited to the repair or replacement of the defective unit when it is returned to us prepaid. This warranty will be considered void if the unit was tampered with, improperly serviced or subject to misuse, neglect or accidental damage.-

SPECIFICATIONS

Output power, 2 channels driven	
4-OHM, 1 KHz, 1% THD.	3Wx2
4-OHM, 1 KHz, 10% THD.	4Wx2
Peak Power	15Wx2
Total Harmonic Distortion, 1 KHz Rated Power	0.3%
Input Sensitivity, 1 KHz, 4-ohm Rated Power	
AUX	150mV
CD	150mV
MIC	2.5mV
Signal to Noise Ratio, 1 KHz, 4-ohm Rated Power	
AUX	75dB
CD	75dB
MIC	65dB
Frequency Response, 1KHz 1W, +/-3dB (8-OHM)	30Hz - 20KHz
Power Requirement	120V AC 60Hz or 230V AC 50Hz
Dimensions	190x70x137mm (WxHxD)

Free Manuals Download Website

<http://myh66.com>

<http://usermanuals.us>

<http://www.somanuals.com>

<http://www.4manuals.cc>

<http://www.manual-lib.com>

<http://www.404manual.com>

<http://www.luxmanual.com>

<http://aubethermostatmanual.com>

Golf course search by state

<http://golfingnear.com>

Email search by domain

<http://emailbydomain.com>

Auto manuals search

<http://auto.somanuals.com>

TV manuals search

<http://tv.somanuals.com>