

PVA3U

60 WATTS HI-FI MINI AMPLIFIER USB/SD CARD PLAYER



Owner's Manual

WWW.PYLEAUDIO.COM

Table of Contents

	Page
Introduction.....	1
Intended use.....	2
Explanation of symbols.....	2
Safety instructions.....	3
Setup.....	5
Connection and control elements.....	6
Connection.....	9
Connecting the chinch inputs.....	9
Connecting the loudspeaker outputs.....	10
Connecting the power supply.....	11
Operation.....	13
Switch on/off.....	13
General Functions.....	13
Operation with external devices.....	14
Operation with integrated MP3 player.....	15
Handling.....	17
Maintenance.....	17
Changing the battery in the remote control.....	18
Cleaning.....	18
Fuse replacement.....	19
Disposal.....	19
Troubleshooting.....	20
Technical data.....	21

Introduction

Dear Customer,

Thank you for purchasing this product.

This product complies with the national, the American and European legal requirements. We kindly request the user to follow the operating instructions, to preserve this condition and to ensure safe operation!

These operating instructions relate to this product. They contain important information concerning commissioning and handling. Please bear this in mind when passing on the product to a third party. Keep these operating instructions for future reference!

All company names and product names are trademarks of the respective owner. All rights reserved.

Intended Use

The miniature amplifier is intended for use in private music systems.

The device serves to amplify low-level audio signals and play back MP3 music files stored on USB storage media or SD/MMC memory cards.

This is achieved by connecting the miniature amplifier between the signal source to be amplified and the loudspeakers.

This product is only approved for the connection to 110V 60Hz or 220V 50Hz alternating voltage. It can only be used in closed rooms, and therefore not outdoors. Contact with moisture, such as in bathrooms, must be avoided.

The conditions described above could damage the product and could cause short-circuits, fire, and electric shock, etc. No part of the product should be altered or modified and the housing should not be opened!

The safety instructions must be observed at all times.



Observe all safety instructions in these operating instructions!

Explanation of symbols



The lightning symbol in a triangle warns you against unprotected live components or elements inside the housing or „live“ connection points. Coming into contact with these components or connection points may be fatal.

Cables connected to such connection points may only be connected by an expert or you have to use ready to connect cables.

The device contains no parts that should be serviced by the user. Therefore, do not open the device.



The exclamation mark symbol on the device indicates that the user should read these operating instructions prior to using the product.



The "Hand" symbol indicates special tips and operating information.

Safety instructions



The guarantee/warranty will be void if damage is incurred resulting from non-compliance with the operating instructions. Liability for any and all consequential damage is excluded!

Nor do we assume liability for damage to property or personal injury, caused by improper use or failure to observe the safety instructions. In such cases the guarantee/warranty will be void.

Dear customer, The following safety instructions and risk information do not serve for protection of the device but for protection of your health. Please read carefully through the following points:



- For safety and licensing (CE) reasons, unauthorised conversion and/or modifications to the product are not permitted.

- All persons operating, installing, setting up, commissioning or servicing this device must be trained and qualified correspondingly and observe these operating instructions.



- The device is designed according to protection class II. Only connect the amplifier to a normal mains socket (110V 60Hz 220V 50Hz).

- The device must be set up correctly. Please also follow these operating instructions.

- When setting up the product, make sure that the mains cable is not pinched or damaged by sharp edges.

- If the amplifier or its connection cable is damaged, do not touch it. First of all, de-energize the corresponding mains socket (e.g. via the respective circuit-breaker) and afterwards carefully pull the mains plug from the socket. Do not use the product afterwards, but take it to a specialist workshop.

- The product is not a toy and should be kept out of reach of children! Children cannot judge the dangers involved when handling electrical devices.

- Do not place any containers with liquid, e.g. buckets, vases or plants in the immediate proximity of the product. Liquids could seep into the casing and in doing so impair the electrical safety of the device. There is furthermore a high risk of fire or of a life-threatening electric shock. If this is the case, de-energize the respective socket (e.g. switch off circuitbreaker) and only then pull the plug-in mains unit from the socket. Disconnect all cables from the device. Afterwards, the product must no longer be used; take it to a specialist workshop.

- Never touch the mains plug of the amplifier with wet or damp hands. There is a risk of a fatal electric shock.



- Make sure the device is adequately ventilated when in operation. Do not cover the ventilation openings with magazines, blankets, curtains or similar. Keep a minimum distance of approx. 15cm to other devices.



- Do not expose the device to high temperatures, dripping or splashing water, strong vibrations or high mechanic stress.
- Do not place open sources of fire such as burning candles alongside the appliance.
- Consult an expert when in doubt about the operation, the safety or the connection of the device.
- Do not operate the light when it is unattended.
- Only use the appliance in a moderate climate, and avoid a tropical environment.
- Do not leave packing material unattended. This may become dangerous playing material for children.
- Please also observe further safety instructions in the individual chapters of this operating manual.
- Comply with the safety and operating instructions of any other appliances that are connected to the device.
- If you are not sure about the correct connection or if questions arise which are not covered by the operating instructions, please do not hesitate to contact our technical support or another specialist.

Setup

When selecting the installation site, consider the room conditions, meaning the location of the next outlet, etc. Also prevent direct sunlight, vibrations, dust, heat, cold and dampness. Keep the appliance away from strong transformers or motors.



Place the amplifier on a stable, horizontal surface. There must be enough space around the system for air circulation to permit dissipation of the generated heat. Therefore, only place the amplifier on a level surface and not on carpets, etc. Do not cover up the ventilation slots in the casing.

If you do not heed these instructions, the device may be damaged.





Do not drill extra holes or screw any extra screws for mounting purposes into the case. This will damage the device.

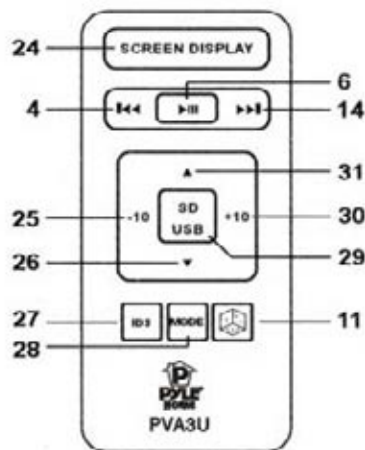
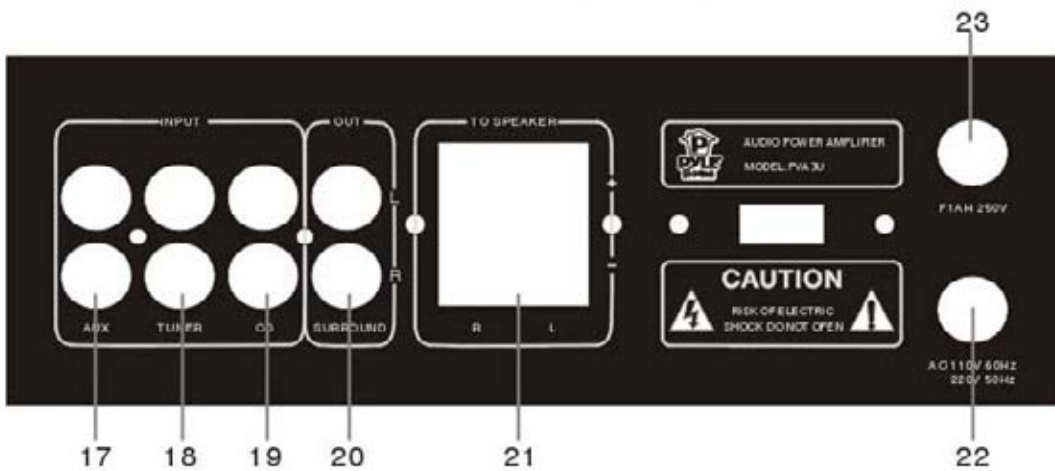
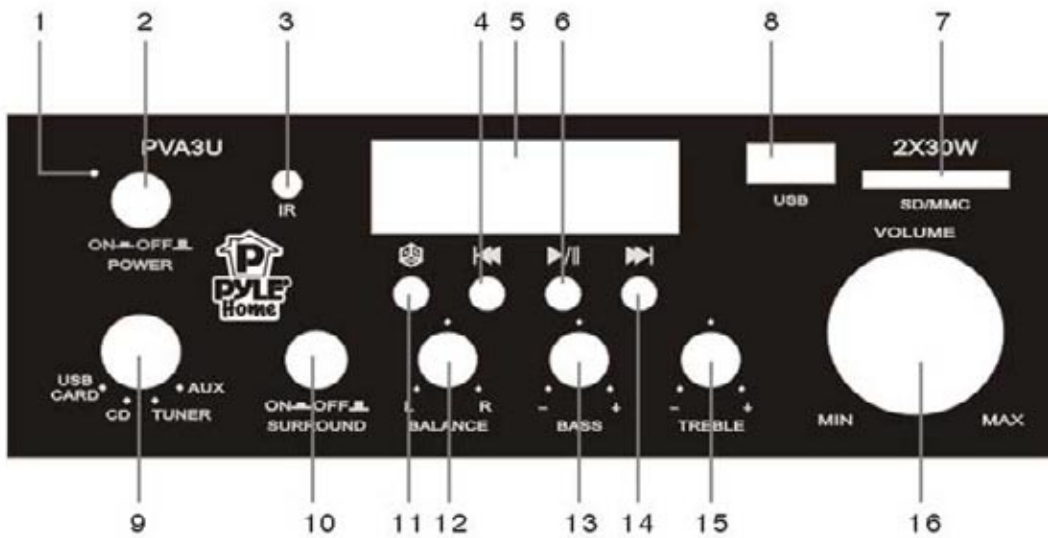

Because of the variety of used lacquers and polishes for furniture, the device base might leave residues on furniture due to a chemical reaction. That's why do not place the device without appropriate protection on the valuable furniture surfaces.

Connection and Operating elements



- | | |
|---|---|
| (1) Power indicator | (17) Cinch input AUX |
| (2) POWER main switch | (18) Cinch input TUNER |
| (3) IR receiver | (19) Cinch input CD |
| (4) Button  | (20) Effect loudspeaker output SURROUND |
| (5) Display | (21) Loudspeaker output SPEAKER |
| (6) Button  | (22) Power cable |
| (7) SD/MMC card reader | (23) FUSE holder |
| (8) USB connection | (24) SCREEN DISPLAY button |
| (9) Input selection switch | (25) Button “-10” |
| (10) SURROUND button | (26) Button ▼ |
| (11) Button  | (27) Button ID3 |
| (12) BALANCE control | (28) MODE button |
| (13) BASS control | (29) USB/SD button |
| (14) Button  | (30) Button “+10” |
| (15) TREBLE control | (31) Button ▲ |
| (16) VOLUME control | |

Connection



Make sure that the mains plug is unplugged before connecting the device and that the volume control VOLUME(16) is set to minimum (left stop). Before connecting the device, turn off all other equipment to be connected to the mixing desk.

Connecting the cinch inputs



For the connection of the cinch inputs only use the shielded cinch wires. The use of other cables might cause interferences. To avoid distortion or mismatching that may damage the device, only sources with a cinch output may be connected to the cinch inputs of the device.

You may connect devices with a LINE output level, a CD player or cassette deck, to the stereo cinch inputs of the amplifier.

These inputs are not suitable for the direct connection of a record player. In this case, you have to switch an equalizer pre-amplifier upstream .

The white cinch socket of the amplifier is connected with the left cinch output of the respective control source (e.g. CD player).

The red cinch socket of the amplifier is connected with the right cinch output of the respective control source (e.g. CD player).

(17) Cinch input AUX

This is where you connect the audio cinch output sockets of a cassette recorder, video recorder, satellite receiver, etc.

(18) Cinch input TUNER

Connect the audio cinch outputs of the radio to these connections.

(19) Cinch input CD

Connect the audio cinch outputs of the CD player to these connections.

Connecting the loudspeaker outputs



The line towards the loudspeakers must be a bifilar cable. Insulate all connecting terminals. Ensure there are no sharp edges which could damage the cables. Only use loudspeakers which have a sufficiently high loading capacity ("see Technical Data").

Connect the loudspeakers directly with the amplifier.
Do not use headphone adapters or distribution boxes. If you are unsure about anything, please contact a specialist.

Make sure that all loudspeakers have the correct polarity, i.e. the plus and minus signs must match.

This amplifier has been designed for a loudspeaker impedance of 4 Ohm on each channel. Only connect one loudspeaker to each output.

- To open the loudspeaker clamps, press the red/black plastic surface. Slide the stripped end of the loudspeaker cable into the aperture and release the plastic surface. The loudspeaker cable is clamped and good contact is guaranteed.

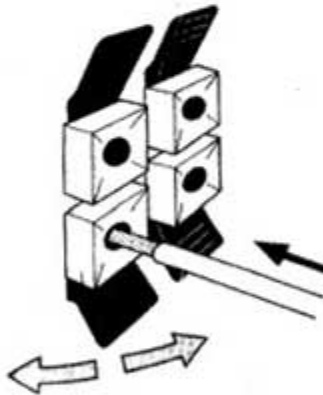

Connect the loudspeakers to the clamps marked with SPEAKER(21).

- Connect the (+) pole of the left loudspeaker with the red speaker clamps marked with „L+“.
- Connect the (-) pole of the left loudspeaker with the black speaker clamps marked with „L-“.
- Connect the (+) pole of the right loudspeaker with the red speaker clamps marked with „R+“.
- Connect the (-) pole of the right loudspeaker with the black speaker clamps marked with „R-“.

(20) Effect loudspeaker output SURROUND

A mono loudspeaker surround signal (effect signal) is applied to this effect output when pressing the SURROUND switch (10).

Here you can connect additional passive loudspeakers. These loudspeakers can be used as rear loudspeakers to achieve a better spatial playback effect.

The white cinch socket of the amplifier is connected with the left, rear loudspeaker.

The red cinch socket of the amplifier is connected with the right, rear loudspeaker.



The rear speakers are switched in series.

This is why the surround outputs only work when both rear speakers are connected.

The minimum impedance per rear speaker is 4 Ohm per speaker.

The rear speakers carry an effect signal that strongly differs from the „normal“ speaker signal with respect to volume and sound. The surround effect depends on the stereo input signal of the amplifier.

Cinch socket assignment:

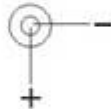

Connecting the power supply



The amplifier's mains switch POWER (2) must be switched off.

- Connect the mains plug of the amplifier's main cable to a socket (110V 60Hz 220V 50Hz) linked to the public power supply network.

Connection example:

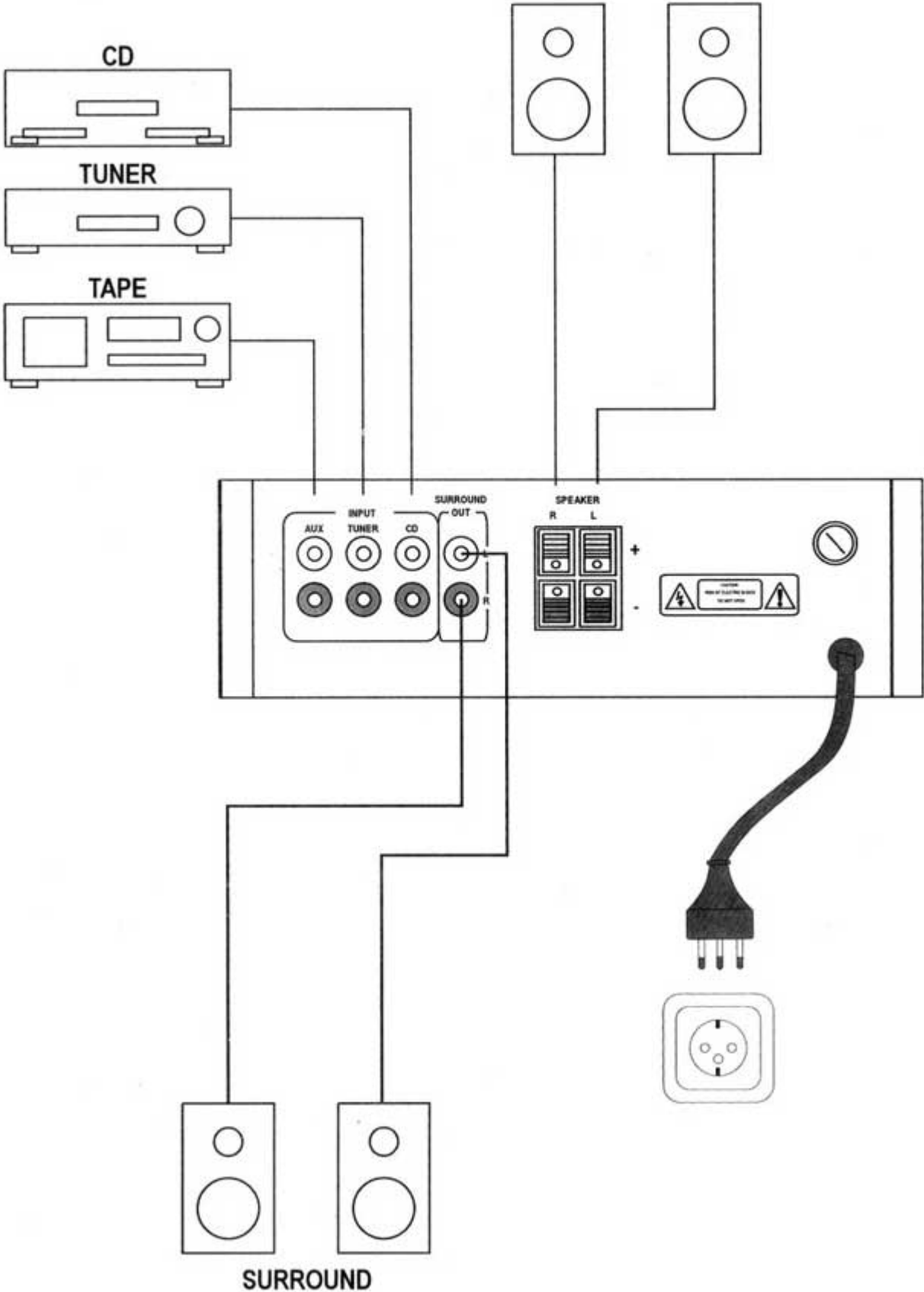

Operation



Please note that sound controls that are turned up very high already require very high performance from the amplifier even at medium value and can easily oversteer it. This results in distortions that may damage the loudspeaker.

In case of high volumes and/or highly turned up sound controls, check for distortions and turn down the volume control or the sound controls immediately to prevent damage to the loudspeakers.

Switch on/off

- Check again that all connections are correct.
- Turn the volume control VOLUME(16) to the " MIN " (left stop) setting.
- Switch on the amplifier with the POWER switch (2) (set switch to ON position)
- The power indicator(1) will light up.
- To turn the amplifier off, turn the volume control VOLUME(16) back to " MIN " (left stop) and then turn the amplifier off with the mains switch POWER(2). Put the switch to the OFF position.



If you do not observe this order, the loudspeaker of the amplifier could be damaged.

General Functions

- Turn the sound control(16) clockwise until you achieve the desired volume.
- With the control BALANCE(12), set the volume balance between the left and the right loudspeaker channel. In the central position, playback takes place at the same volume via both loudspeakers. Turning clockwise reduces the volume of the left loudspeaker. Turning counter-clockwise reduces the volume of the right loudspeaker.
- With the control BASS(13), set the intensity of the bass playback. Bass playback is amplified when turning the control clockwise. Bass playback is dampened when turning the control counter-clockwise.
- With the control TREBLE(15), set the intensity of the treble playback. Treble playback is amplified when turning the control clockwise. Treble playback is dampened when turning the control counter-clockwise.
- The button SCREEN DISPLAY(24) on the remote control turns the display on or off.

- With the switch SURROUND(10), you activate the SURROUND output on back of the device.
When the switch is depressed (position “ON”), the surround loudspeakers are on. If the switch is not depressed (position OFF), the device is turned off.
- If you operate the device with the remote control, always point this at the IR receiver(3) and make sure that there are no obstacles between the remote control and the IR receiver(3), which may impair the transmission of the commands.

Operation with external devices

- Switch on the signal sources such as CD players, cassette decks etc.
- With the input selection switch(9), select the desired input source (e.g. CD player).
- Start playback on your input source, if required.

Operation with integrated MP3 player



Please do not press the buttons of the MP3 control too fast in sequence. The device needs some time to read and display the information of the storage media or to execute commands.

If the device does not react immediately to an input, this is not an error but indicates that information is still being requested from the storage medium.

- Turn the input selection switch(9) to the position USB/CARD.
- Insert an SD or MMC card into the SD/MMC card reader(7) or a USB storage medium into the USB connection(8).
- The content of the storage medium is imported.



The respective last inserted medium is always activated.

- If both a memory card AND a USB medium are inserted, you can switch between the two interfaces with the button SD/USB(29) on the remote control.
- Press the button ►/|| (6) to start playback. Press the button again to interrupt playback.
- Press the button ▲ (31) to select the next folder on the storage medium. Playback starts with the first track of the selected folder.
- Press the button ▼ (26) to select the previous folder on the storage medium. Playback starts with the first track of the selected folder.

- Press the button (14) to select the next track on the storage medium.
- Press the button (4) to skip to the start of the current track. To select the previous track on the storage medium, press the button again.
- Press the button +10 (30) to jump 10 tracks ahead.
- Press the button -10 (25) to jump 10 tracks back.

- With the button ID3 (27), you can call up the following ID3 tag information for the currently played track on the display(5):

FILE:	Name of the file on the data carrier
FOLDER:	Name of the folder on the data carrier
TITLE:	Song name
ARTIST:	Artist
ALBUM:	Name of the album
Normal display:	Folder/track and time display

- With the button MODE(28), you select the playback sequence:

FILE REPEAT:	Repeat of the current track
FOLDER REPEAT:	Repeat of the current folder
FILE SCAN:	Each title is briefly played back
REPEAT SCAN OFF:	Normal playback

- With the button (11) you can select random track playback. When random play is activated, the device selects the playback sequence randomly:

RANDOM ON:	Random playback is activated
RANDOM OFF:	Random playback is deactivated



Due to the great variety of systems with USB and SD/MMC card interfaces and their different functions that are sometimes producer-specific, we cannot guarantee that all media will be recognized and that all the operational functions are available in this CD tuner.

USB hard disks cannot be connected to this device.

SD/MMC cards with a capacity larger than 2GB and SDHC cards are not supported.

Handling

- Never plug the power plug into a mains socket immediately after the device was taken from a cold to a warm environment. The resulting condensation water may damage the device.

Allow the device to reach room temperature before connecting it. Wait until the condensation water has evaporated.

- Never pull the mains plug by pulling the cable from the socket. Always only use the thus provided grip area.
- Remove the mains plug from the electrical outlet if the device is not in use for a longer period of time.
- For safety reasons always pull the mains plug from the socket during a thunderstorm.
- Do not listen to excessively loud music for long periods of time. This may damage your hearing.

Maintenance

Periodically check the technical safety of the amplifier, e.g. check for damage to the power cable or the housing.

If you have a reason to believe that the device can no longer be operated safely, disconnect it immediately and secure it against being operated unintentionally. Pull the power plug out of the socket outlet!

It can be assumed that safe operation is no longer possible if:

- there is visible damage to the device or to the power line,
- the device no longer works
- it has been stored for a long time under unfavourable conditions
- after exposure to extraordinary stress caused by transport

Always observe the following safety instructions before cleaning or servicing the amplifier:



Live components may be exposed if the covering is opened or components are removed.

Prior to start of maintenance or repair works, the device must be disconnected from all voltage sources.

Capacitors inside the device may still carry voltage even though they have been disconnected from all voltage sources.

Only qualified experts familiar with the hazards involved and the relevant regulations may perform repairs.

Changing the battery in the remote control



Remove the battery when the device is not being used for longer periods of time.

Leaking or damaged batteries might cause acid burns when getting into contact with skin. Therefore, use suitable protective gloves.

Make sure that the batteries are neither short-circuited nor thrown into a fire. Do not recharge batteries. Danger of explosion!

- If the remote control no longer functions properly, the battery is discharged and must be replaced.
- Pull the battery holder out of the back of the remote control.
- Remove the spent battery and insert a new 3V lithium button cell CR2032. The battery holder has a reverse polarity protection.
- Slide the battery compartment cover onto the remote control again.

Cleaning

The outside of the device should only be cleaned with a soft dry cloth or a soft brush. Never use aggressive cleansing agents or solvents since these may damage the surface of the housing or impair its operation.

Fuse replacement

If you have to replace fuses, ensure that you only use fuses of the same type and rated current (see "Technical data").



It is absolutely impermissible to repair fuses or to bridge the fuse holder.

- Switch off the amplifier and all the devices connected.
- Disconnect the mains plug from the mains socket.
- Open the fuse compartment FUSE (23) with the aid of a screwdriver turning it in anticlockwise direction.
- Replace the defective fuse with a new fuse of the same type.
- Retighten the screws on the fuse holder FUSE(23).

Disposal



Please dispose of the inoperative device according to the current regulations.

Disposal of used batteries/rechargeable batteries



The user is legally obliged (battery regulation) to return used batteries and storage batteries. Do not dispose of used batteries via the household rubbish.

Contaminated batteries/rechargeable batteries are labelled with these symbols to indicate that disposal in domestic waste is forbidden. The symbols for dangerous heavy metal constituents are: Cd = cadmium,



Hg = mercury, Pb = lead. You can return used batteries/storage batteries free of charge to any collecting point of your local authority, to our stores or to any other store where batteries/storage batteries are sold.

Troubleshooting

In purchasing the miniature amplifier, you have acquired a product which uses the most up-to-date technology available and is operationally reliable. Nevertheless, problems or faults may occur.

Therefore, we would like to describe here how to eliminate possible faults:



Always observe the safety instructions!

No sound is audible:

- A device in the playback chain is not turned on.
- The wrong input was selected on the amplifier.
- The volume control (16) is set to minimum.
- Fuse defective.

One channel does not function:

- A cinch cable was disconnected from the source device (e.g. the cassette recorder) or the cinch inputs (17-19).
- The balance control BALANCE (12) was set wrongly on the amplifier.
- A loudspeaker cable was disconnected from the loudspeaker clamp.

The sound is distorted:

- The amplifier input receives an excess signal.
- The volume is set too high and the loudspeaker distorts.
- The controls BASS (13) or TREBLE (15) were set too high.

Playback is without bass:

- One loudspeaker is connected the wrong way.
- The bass control (13) on the amplifier is set to minimum.

Playback is without treble:

- The treble control(15) on the amplifier is set to minimum.
- USB storage media or SD/MMC cards are not detected:
- The USB device or the memory card are not compatible with the device.
- The USB device or the memory card are not formatted in FAT or FAT32 format.
- You are using a device with an excess power consumption(hard disks cannot be used!)



Repairs other than those described above should only be performed by an authorised specialist.

Technical data

Operating voltage:	110V 60 Hz 220V 50 Hz
Power consumption:	65W
Battery remote control:	3-V lithium button cell CR2032
Fuse:	F1AH250V(5×20mm)
Input sensitivity:	400mV
Output power:	Front 2×12W RMS at 8 Ohm 2×15W RMS at 4 Ohm Surround 2×6W RMS at 8 Ohm
Distortion factor:	<0,1%
Frequency curve:	20-20,000Hz
S/N ratio:	>70dB(A)
Channel separation:	40dB
Sound control:	Bass +/-10dB/100Hz Treble +/-10dB/10kHz
Dimensions:	63×180×150mm
Weight:	1.9kg

Free Manuals Download Website

<http://myh66.com>

<http://usermanuals.us>

<http://www.somanuals.com>

<http://www.4manuals.cc>

<http://www.manual-lib.com>

<http://www.404manual.com>

<http://www.luxmanual.com>

<http://aubethermostatmanual.com>

Golf course search by state

<http://golfingnear.com>

Email search by domain

<http://emailbydomain.com>

Auto manuals search

<http://auto.somanuals.com>

TV manuals search

<http://tv.somanuals.com>