

**PYRAMID<sup>®</sup>**  
**Studio**  
**PRO**

**High Performance Professional Audio**

**MODEL: PA600X/PA800X/PA1000X/  
PA1800X PA AMPLIFIER**

[www.pyramidcaraudio.com](http://www.pyramidcaraudio.com)

# INTRODUCTION

Your New PYRAMID PA SERIES AMPLIFIER gives you the power and versatility you need in a professional sound system.

The amplifier's wide frequency response makes it suitable for amplifying music or vocal program material. It can be used for live bands, office paging systems, public announcements, or a variety of other installations.

Please read this manual thoroughly before you attempt to set up and use the amplifier. It contains a range of installation suggestions as well as instructions to ensure safe usage. Installed properly, you can expect years of trouble-free service from this product.

## FEATURES AND CONTROLS

### FRONT PANEL - PA600X/PA800X/PA1000X/PA1800X

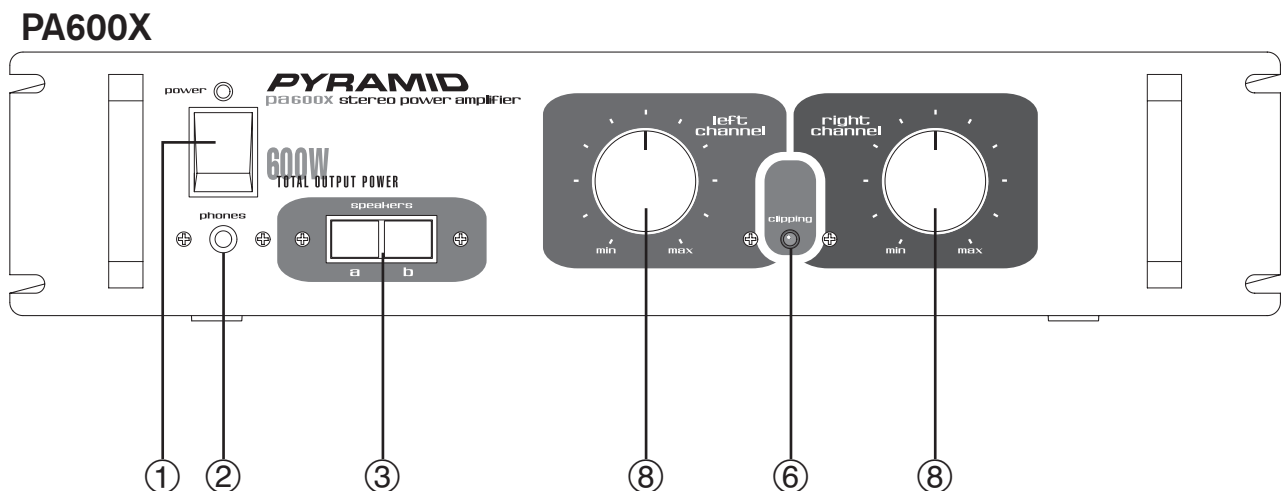

# PA800X

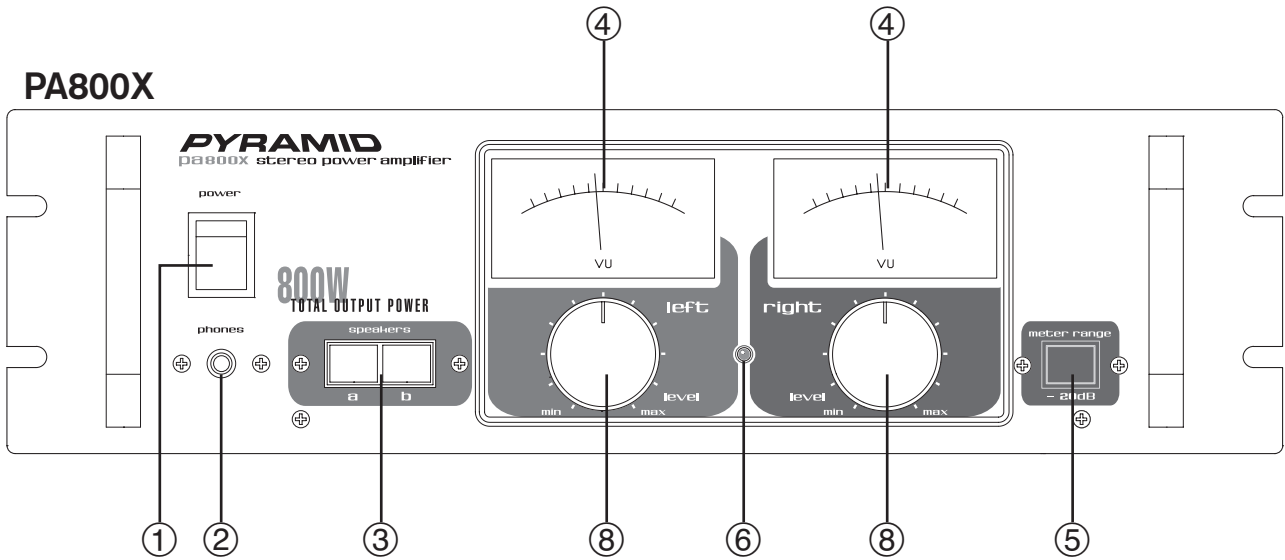

# PA1000X

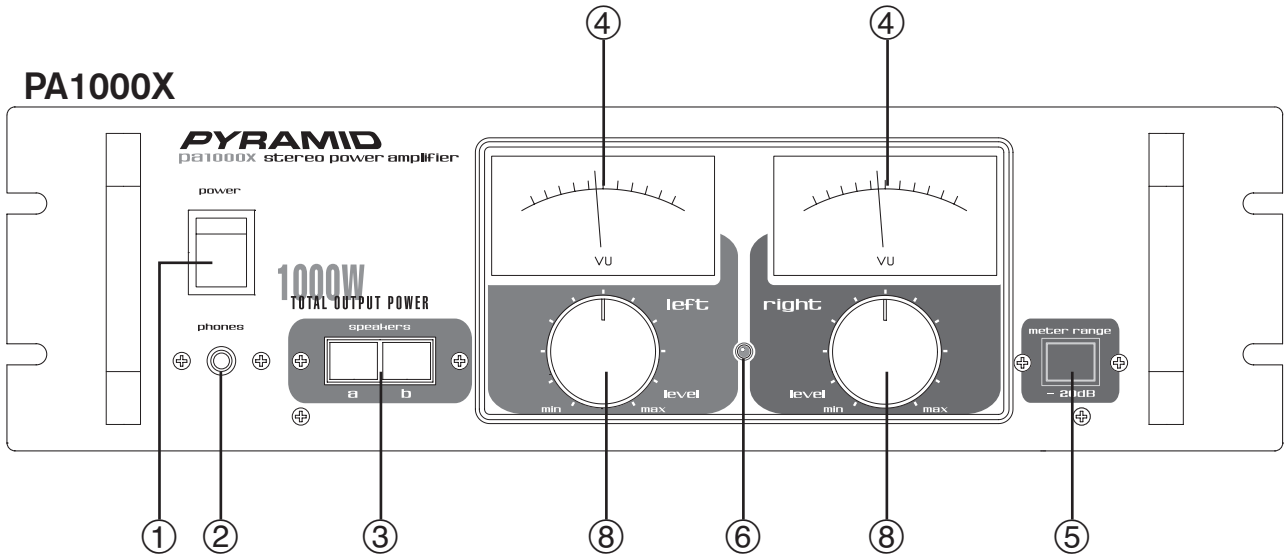

# PA1800X

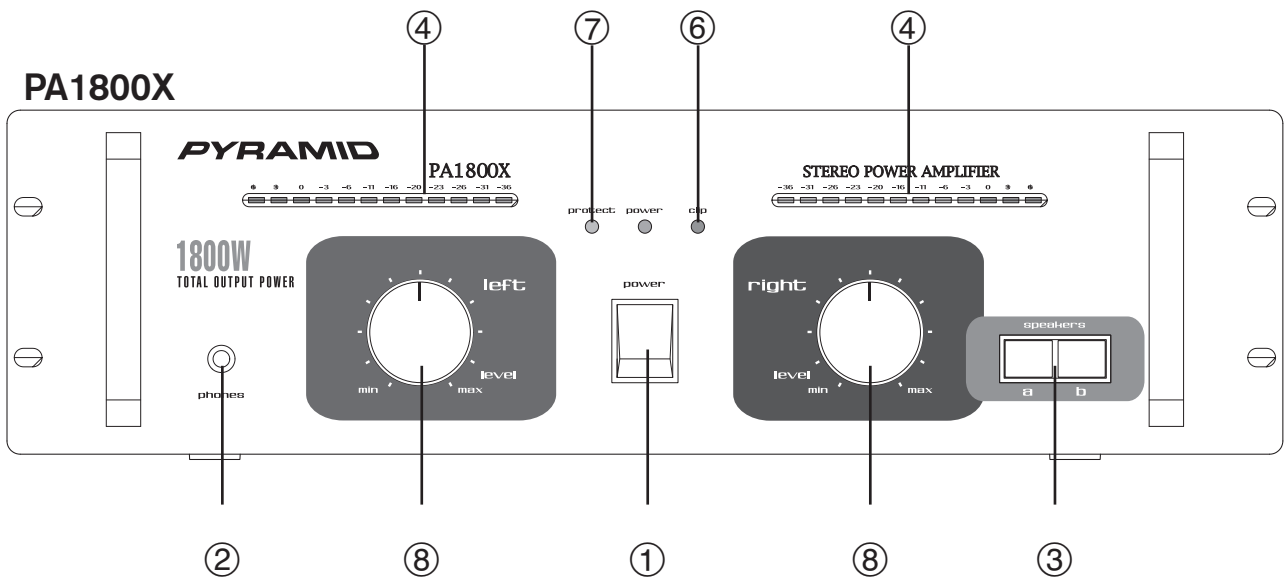

# FRONT PANEL - PA600X/PA800X / PA1000X/PA1800X

## 1.Power On/Off

## 2.Phone Jack

Lets you connect a pair of stereo headphones for private listening or cueing (monitoring) sound prior to "airing" it.

## 3.Speaker A/B Selector Switches

Permit you to select speakers attached to terminal set A, set B, or both.

## 4.Left and Right Power Meters (PA800X/PA1000X/PA1800X)

Indicate the output signal level for each channel.

## 5.Meter Range Switch (PA800X/PA1000X)

Controls the sensitivity of the power meter.

## 6.Clip Circuit and Indicator

This special circuitry protects the amplifier and speaker system from being damaged by overdriving power levels. Indicator lights remind the user to reduce the volume when amplifier output is excessive.

## 7.Protection Circuit and Indicator (PA1800X)

The indicator will be illuminated when the amplifier is powered on and at turn-on delay status; the indicator will be turned off after internal outputs are connected. The indicator will also be illuminated when the amplifier has abnormal problems, such as overload or excessive heat.

## 8.Left and Right Output Level Controls

Lets you adjust the sound levels for each channel.

In the mono bridged mode (PA1000X/PA1800X), only the left gain control will adjust the output level.

# REAR PANEL - PA600X

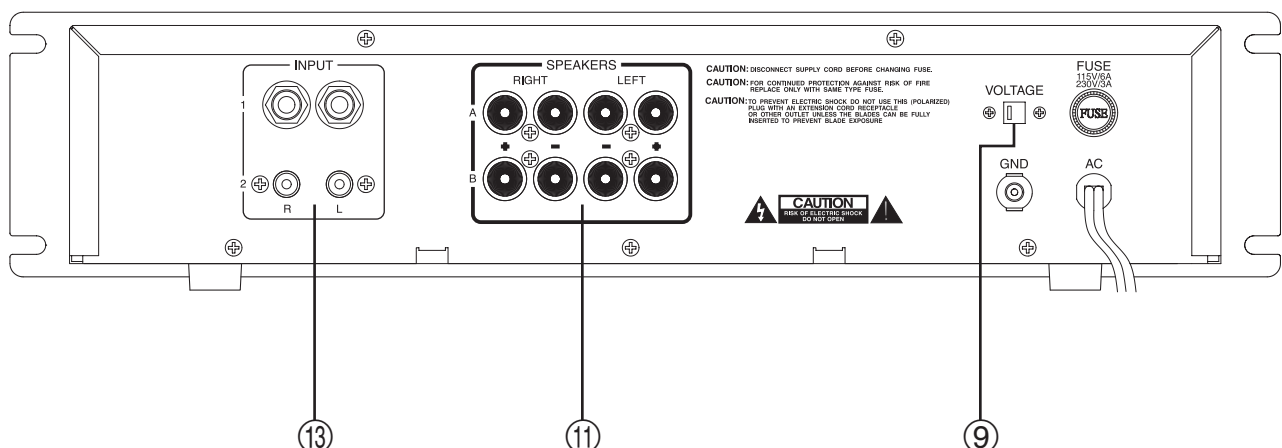

## REAR PANEL - PA800X / PA1000X / PA1800X

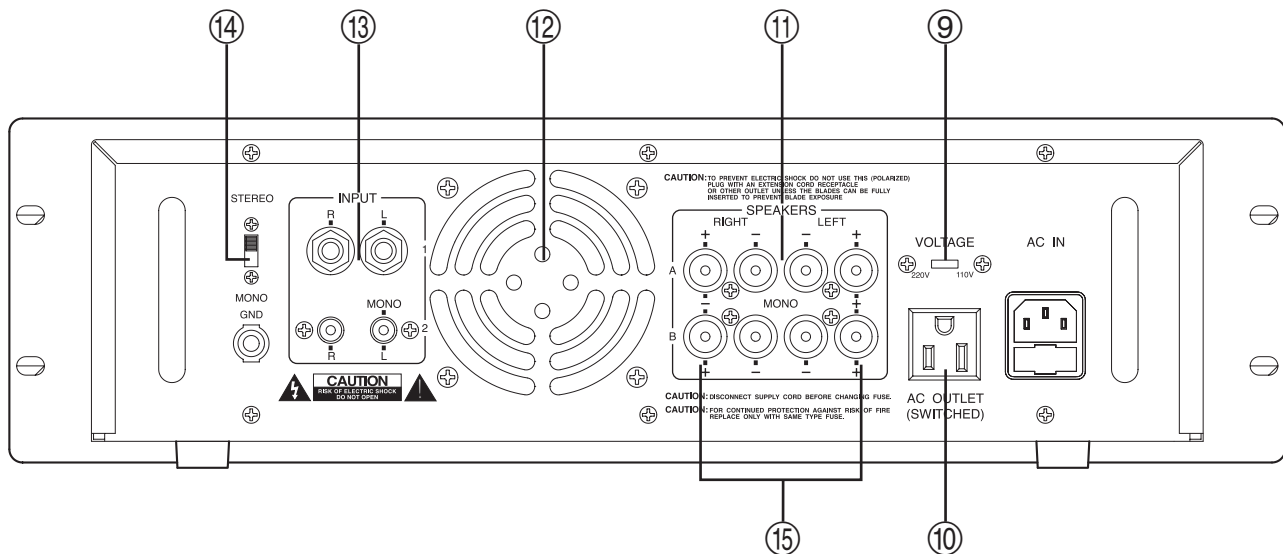

## REAR PANEL - PA600X / PA800X / PA1000X / PA1800X

### 9.Voltage Switch

The amplifier has selectable input voltage from 110V/60Hz which is the standard in USA and CANADA. You can also switch the input voltage to 220V/50Hz for EUROPEAN operation. Please make sure the switch is in the proper position before operating, otherwise severe damage will result not cover by the warranty. Please also replace the fuse with proper rating in this situation (see the SPECIFICATIONS for the fuse rating).

### 10.Switched AC Accessory Outlet (PA800X/PA1000X/PA1800X)

There is supplied AC OUTLET (SWITCHED MAX. 400W) which allow the electrical hook up of other units.

### 11.Speaker Terminals

Permits hook up of two stereo pair of speakers via the wire terminals. You can choose either Channel A , Channel B, or use both at the same time. Speaker impedance can range from 4 to 16 Ohms.

### 12.Fan Cooling (PA800X/PA1000X/PA1800X)

Cooling system is automatically activated whenever amplifier is turned on. This forced air cooling system rapidly exhausts interior heat, reducing operating temperature and aiding performance.

### 13.Input Jacks

Let you connect a variety of audio input sources via the balanced 6.35mm phone jack or unbalanced RCA inputs.

### 14.Stereo/Mono Switch (PA1000X/PA1800X)

Lets you select bridged mono input mode in combination with a mono signal source plugged into the LEFT input channel, or conventional stereo operation with a stereo input signal.

### 15.Mono Bridged Output (PA1000X/PA1800X)

Connect the speaker's positive (+) to the amplifier's LEFT/RED (+) terminal and negative (-) to the amplifeir's RIGHT/RED (+) terminal.

## INSTALLATION GUIDELINES

**Connecting the GND (GROUND) screw terminal**  
 Connecting a mixer or preamplifier may cause excessive noise or hum in the amplifier output. To prevent this, connect one end of a low-capacitance shield wire to the amplifier's ground screw (on the rear panel). Then connect the other end of this wire to the ground terminal on the mixer or preamplifier enclosure.

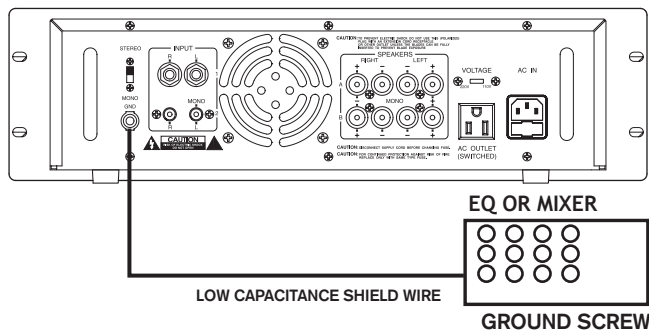

### Input connections

These amplifiers accept a board range of input sources, including Compact Disc (CD) players; Cassette, Reel-to-Reel or other tape players; Radio Tuners; Equalizers; Signal Processors.

**Connecting a CD or tape player, or tuner**  
 In a normal installation, one would use the **RCA JACKS** for connecting a CD player, tape player or tuner.

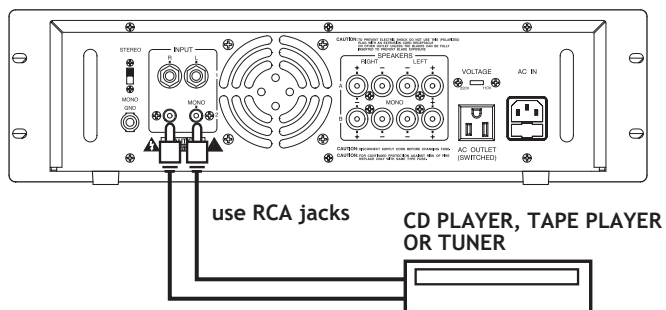

### Connecting an equalizer or external signal processor

Connect the processor's **OUT** to the amplifier's **IN** connector.

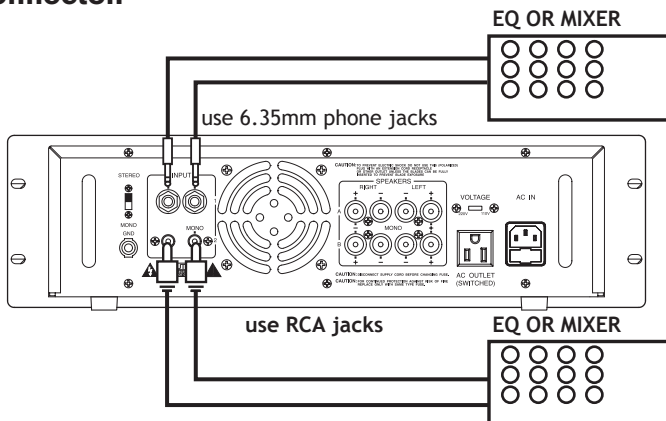

### Stereo or Mono Inputs (PA1000X/PA1800X)

The PA1000X and PA1800X can be operated in Stereo or Mono mode, depending on the input source. If the input signal is mono, connect the source via the **LEFT** input only (also marked "MONO" on the back of amplifier). Then slide the **STEREO/MONO** selector switch to **MONO** and the signal will be routed through both channels.

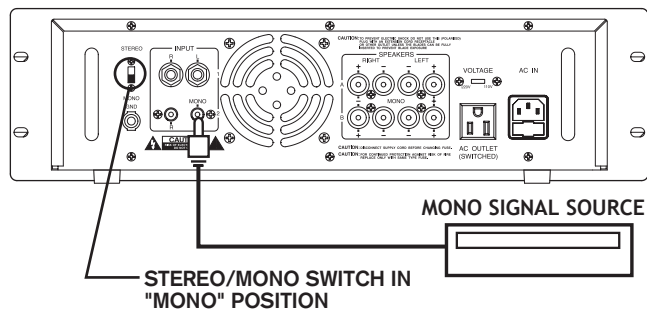

### Speaker connections

You can connect 4 Ohm, 8 Ohm, or 16 Ohm speakers to Channel A and/or Channel B of the amplifier. If you connect two pairs of speakers, be sure to follow these guidelines:

- Speakers which are connected to the same channel are part of a pair, and must be of the same impedance.
- Speakers connected to different channels are **NOT** part of a pair, and can be of different impedances.

1. Prepare the speaker wire by removing about 1 inch of insulation from the end of speaker wire you intend to connect to the amplifier. Then twist the exposed wire to secure all the wire strands.

**NOTE:** Use 18-gauge speaker wire for lengths up to 25 feet; 16-gauge wire for lengths over 25 feet. It is recommended that you use the shortest length of wire possible.

2. Connect the speaker wire to the speaker's positive and negative terminals.

**NOTE:** Most speaker terminals are either color-coded or have a mark that indicates the terminal's polarity. Usually positive terminals are red or have a plus symbol (+), and negative terminals are black or have a minus symbol (-).

3. Connect the speaker wires to the amplifier's left and right speaker terminals according to the terminal color polarity.

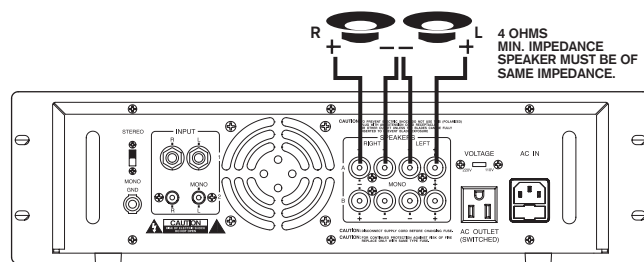

## Bridge Mode Operation (PA1000X/PA1800X)

The PA1000X and PA1800X can be operated in mono bridged output mode, if your speakers can handle the following power output levels:

PA1000X: 320 watts

PA1800X: 420 watts

As shown in the diagram below, connect the speaker's positive (+) to the amplifier's red speakers left (A/B) terminals and negative (-) to red speakers right (A/B) terminals.

The speaker right (+) on the amplifier is used a negative (-) terminal for a bridged connection.

**NOTE: IT IS SUGGESTED TO USE A 8-OHM SPEAKER FOR THE ONE CHANNEL BRIDGE HOOKUP. IF YOU CONNECT TWO CHANNELS' BRIDGE HOOKUP, PLEASE MAKE SURE THE SPEAKER IMPEDANCE MUST BE 8-OHM MINIMUM.**

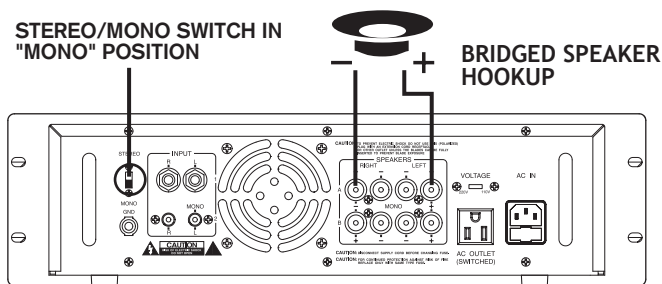

## Using headphones

To listen privately, or to monitor sound sources, connect a pair of low impedance stereo headphones (not supplied) with 6.35mm plug into the PHONES jack on the amplifier front panel.

Please listen safely. Follow these recommendations: Do not listen at extremely high volume levels. Extended, high-volume listening can lead to permanent hearing loss.

Always start with the volume control set to a LOW level BEFORE you put the headphones on. Then gradually increase the volume as necessary.

## Connecting to standard AC power

After making all other connections, set the POWER switch to OFF position. Then connect the power cord to a standard AC outlet.

## Mounting the amplifier

This amplifier is designed to accept standard rack mounting installations. Two slots on each end of the front panel make it suitable for such an installation.

Tightly secure four mounting screws (not supplied) through these four slots and into your standard electronics equipment rack.

## Turning the amplifier on

1. Turn on the audio input source equipment which is connected to the amplifier INPUT jack.
2. Set the amplifier's left and right output level gain controls to the minimum level settings.
3. Press the power switch to turn the amplifier on.

## Using the power meter (PA800X/PA1000X/PA1800X)

The meter POINTER (PA800X/PA1000X) and/or LED (PA1800X) position indicate the amplifier output power. For ease of reading in dark environments, the VU meter (PA800X/PA1000X) is illuminated.

## Using the meter range selector (PA800X/PA1000X)

When output power is too strong, the meter's pointer might continuously swing to the extreme right and damage or reduce the accuracy of the meter. To protect the meter, you can use the meter range selector to control the amplifier's sensitivity to the input power signal.

Leave the meter range switch in the OUT position to maintain a 0 dB gain for the meter. When output power is not strong, leave the meter range switch in the IN position to allow a +20dB gain.

## Using the left and right Output Level controls

Rotate output level gain clockwise to increase, or counterclockwise to decrease the output power. To get the best performance with the least sound distortion, always adjust the output level gain so the meter's level indication does not continuously exceed to the extreme right.

**CAUTION:** It is possible to overdrive the amplifier by setting output level gain too high, which may cause damage or failure.

## About the internal clip circuitry

Special clip circuitry incorporated into your amplifier's design protects the amplifier and speaker system from being damaged from overdriving power.

Under normal conditions, the amplifier's clip indicator will flicker as the output power momentarily exceeds the level as set by the output level gain selector.

However, under excessive output conditions, the clip indicator lights remain on continuously, altering you that the special clip circuitry has become active. When this occurs, you should simply reduce the output power level by rotating the Master Volume control counterclockwise.

## Using the A/B Speaker Selector Switch

You can listen to speakers on set A or set B individually or simultaneously. Simply push in or out the desired speaker set to make your selection.

**CAUTION:** If the impedance of your speakers is 4 OHMS, do not use both the speaker A and speaker B terminal at the same time as the net impedance may be low enough to damage your amplifier.

### Caring for your PYRAMID amplifier

Your PYRAMID amplifier is an example of superior design and craftsmanship. The following suggestions will help you care for your amplifier so you can enjoy years of use:

- Keep the amplifier dry. If it gets wet, wipe immediately.
- Use the amplifier only in well-ventilated installations.
- Handle the amplifier away from dust and dirt.
- Wipe occasionally with a damp cloth to keep it looking new.

Do not use harsh chemical, solvents or detergents!

### Replacing a fuse

This amplifier requires a fuse with the proper rating for protection from power surges and short circuits. If the amplifier suddenly turns off or will not turn on, the fuse is properly blown.

### Remove the old fuse and replace it with an identical, serviceable fuse:

PA600X = 6A (110-120V) OR 3A (220-240V)  
 PA800X = 6A (110-120V) OR 3A (220-240V)  
 PA1000X = 6A (110-120V) OR 3A (220-240V)  
 PA1800X = 7A (110-120V) OR 3.5A (220-240V)

**CAUTION:** Never use a fuse with a higher rating.

Amplifier Specifications	PA600X	PA800X	PA1000X	PA1800X
Input Impedance	20 k-Ohms	20 k-Ohms	20 k-Ohms	20 k-Ohms
<b>Continuous Output Power</b>				
<b>Stereo Mode</b>				
20 Hz to 20 kHz, 8 Ohms	70W X 2	100W X 2	110W X 2	160W X 2
1 kHz, 4 Ohms	90W X 2	120W X 2	160W X 2	210W X 2
Maximum power, 8 Ohms	300W X 2	400W X 2	500W X 2	900W X 2
Maximum power, 4 Ohms	600W X 2	800W X 2	1000W X 2	1800W X 2
<b>Bridge Mode</b>				
20 Hz to 20 kHz, 8 Ohms			250W X 1	350W X 1
1 kHz, 4 Ohms			320W X 1	420W X 1
Maximum power, 8 Ohms			1000W X 1	1800W X 1
Maximum power, 4 Ohms			2000W X 1	3600W X 1
THD at rated output power	0.1%	0.1%	0.1%	0.1%
Frequency Response +/-3dB	10 Hz to 50 kHz	10 Hz to 50 kHz	10 Hz to 50 kHz	10 Hz to 50 kHz
Input Sensitivity	0.775V	0.775V	1V	1V
Signal to Noise Ratio A-Weighted	90 dB	90 dB	90 dB	90 dB
<b>Speaker Impedance</b>				
A or B ONLY	4 - 16 Ohms	4 - 16 Ohms	4 - 16 Ohms	4 - 16 Ohms
A plus B	8 - 16 Ohms	8 - 16 Ohms	8 - 16 Ohms	8 - 16 Ohms
Bridged Mode			8 - 16 Ohms	8 - 16 Ohms
Power Requirement	120V AC, 60 Hz / 240V AC, 50Hz			
<b>Power Fuse</b>				
110-120V AC	6A	6A	6A	7A
220-240V AC	3A	3A	3A	3.5A
Dimensions H x W x D, inches	4 3/16 X 19 X 10 3/4	4 15/32 X 19 X 12	4 15/32 X 19 X 12	5 1/8 X 19 X 12
(mm)	100 X 482 X 273	130 X 482 X 305	130 X 482 X 305	130 X 482 X 305
Weight, lbs (kg)	21.78(9.9)	26.84(12.2)	26.4(12)	26.84(12.2)



## Free Manuals Download Website

<http://myh66.com>

<http://usermanuals.us>

<http://www.somanuals.com>

<http://www.4manuals.cc>

<http://www.manual-lib.com>

<http://www.404manual.com>

<http://www.luxmanual.com>

<http://aubethermostatmanual.com>

Golf course search by state

<http://golfingnear.com>

Email search by domain

<http://emailbydomain.com>

Auto manuals search

<http://auto.somanuals.com>

TV manuals search

<http://tv.somanuals.com>