

# User Manual

## **QT SERIES**



H.264 NETWORK DVR



## Thank You for Choosing a Q-See Product!

All of our products are backed by a conditional service warranty covering all hardware for 12 months from the date of purchase. Additionally, our products also come with a free exchange policy that covers all manufacturing defects for one month from the date of purchase. Permanent upgrading service is provided for the software and is available at [www.Q-See.com](http://www.Q-See.com).

Be certain to make the most of your warranty by completing the registration form online. In addition to warranty and technical support benefits, you'll receive notifications of product updates along with free downloadable firmware updates for your DVR. Register today at [www.Q-See.com](http://www.Q-See.com)!

Please see the back of this manual for exclusions.



© 2010, 2012 Q-See. Reproduction in whole or in part without written permission is prohibited. All rights reserved. This manual and software and hardware described herein, in whole or in part, may not be reproduced, translated, or reduced to any machine-readable form without prior written approval.

**Trademarks:** All brand names and products are trademarks or registered trademarks of their respective owners.

**Q-See** is a registered trademark of DPS, Inc.

**Disclaimer:** The information in this document is subject to change without notice. The manufacturer makes no representations or warranties, either express or implied, of any kind with respect to completeness of its contents.

Manufacturer shall not be liable for any damages whatsoever from misuse of this product.

## About this Manual

This manual is written for the QT family of DVRs. Not all features and capabilities are shared across all models so you may see features described which are not applicable or available on your machine. In addition you may see screen images that do not exactly match those on your display.

This manual was accurate at the time it was completed. However, because of our ongoing effort to constantly improve our products, features and functions may have been added or changed since that time and on-screen displays may change. We encourage you to visit our website at [www.Q-See.com](http://www.Q-See.com) to check for the latest firmware updates and product announcements.

Throughout the manual we have highlighted warnings and other important information that will assist you in operating your new system in a safe and trouble-free manner. Please take the time to read and follow all instructions and pay attention to alerts as shown below:



**IMPORTANT!** Red boxes with this icon indicate warnings. To prevent possible injury or damage to the product, read all warnings before use.



**NOTE!** Text in blue boxes with the Information icon offer additional guidance and explanations about how to make the most out of your system.

# TABLE OF CONTENTS

<b>1. INTRODUCTION</b>	<b>7</b>	<b>6. DVR MANAGEMENT</b>	<b>66</b>
For Your Safety	7	6.1 Information	66
Features	8	Event Information	67
		Log Information	67
		Network Information	67
		Online User Information	68
<b>2. CONNECTIONS AND CONTROLS</b>	<b>10</b>	6.2 Manual Alarm	69
2.1 DVR Functions and Connections	10	6.3 Disk Management	69
2.2 Mouse	36	6.4 Upgrade	70
2.3 Remote Control	37	6.5 Logoff	71
		6.6 Shut Down	71
<b>3. BASIC FUNCTIONS</b>	<b>38</b>	<b>7. PAN/TILT/ZOOM CAMERAS</b>	<b>72</b>
3.1 Power On/Off	38	7.1 Connecting a PTZ Camera	72
Power On and Login	38	7.2 Pan-Tilt-Zoom (PTZ) CONFIGURATION	73
Power Off	38		
3.2 The Control Bar	39		
3.3 Live Viewing and Recording	42	<b>8. ALARMS</b>	<b>76</b>
Switching Video Output	42	8.1 Alarm Input	76
Live Viewing	42	8.2 Alarm Output	78
Recording	42	8.3 Alarm Configuration	79
3.4 Quick Playback	43	Sensor	79
		Motion	80
		Video Loss	81
		Other Alarm	81
		Alarm Out	82
<b>4. MAIN MENU SETUP</b>	<b>46</b>	<b>9. HARD DISK DRIVE</b>	<b>83</b>
4.1 Basic Configuration	46	9.1 Installation/Removal	83
Menu Navigation	46	9.2 Calculating the Recording Capacity of a Hard disk Drive	85
Setup	46		
4.2 Live Configuration	49	<b>APPENDIX</b>	<b>86</b>
4.3 Record Configuration	51	A.1 Troubleshooting	86
4.4 Schedule Configuration	54	A.2 Specifications	89
4.5 Network Configuration	55	A.3 Rack Mounting	94
4.6 User Management	59	<b>Q-SEE PRODUCT WARRANTY</b>	<b>95</b>
Time Search	61	Questions or Comments? Contact Us	96
Event Search	62		
File Management	62		
Image	63		
<b>5. BACKUP</b>	<b>64</b>		

**FOR YOUR SAFETY**

To prevent damage to your Q-See product or injury to yourself or to others, read and understand the following safety precautions in their entirety before installing or using this equipment. Keep these safety instructions where all those who use the product will read them.

**WARNING! ELECTRIC SHOCK RISK!**

- Check the unit and any accessories included in the package immediately after opening. If items are missing or damaged, repackage and return to the point of purchase.
- Use the proper power source. Only use the power adapter supplied with your system. Do not use this product with a power source that applies more than the specified voltage (100-240V AC).
- Never insert anything metallic into the DVR. Inserting anything into the DVR or its case can be a source of dangerous electric shock.
- Do not operate in dusty areas. Avoid placing the DVR in places that are dusty.
- Do not expose this product to rain or use near water. If this product accidentally gets wet, unplug it and contact Q-See immediately.
- Keep product surfaces clean and dry. To clean the outside case of the DVR, gently wipe using a lightly dampened cloth (only use water, do not use solvents).
- Do not operate this DVR without the cover securely in place. Do not attempt to do any repairs to the DVR yourself. If there are unusual sounds or smells coming from the DVR, unplug it immediately and contact Q-See technical support. Under no circumstances should the cover be removed while the device is connected to a power source. You should only remove the cover to install/replace the hard disk drive (**See Chapter 9**) or replace the standard 3v lithium cell battery on the motherboard. These are the only user serviceable parts. You may need to replace the battery if the internal clock resets itself after a power outage.
- Handle the DVR carefully. If you accidentally drop your DVR on any hard surface, it may cause a malfunction. If the DVR doesn't work properly due to physical damage, contact an authorized dealer for repair or exchange.
- Make sure there is proper air circulation around the unit. This DVR system uses a hard drive for video storage which generates heat during operation. Do not block air holes located on the bottom, top, sides and back of the DVR as they are designed to keep the system cool while running. Install or place this product in an area where there is ample air circulation.
- Provide proper ventilation. This DVR has a built-in fan that properly ventilates the system. Do not cover or impede this fan.

## FEATURES

This DVR uses high-performance video processing chips and an embedded Linux operating system for quality image recording and ease of use. It utilizes numerous advanced technologies including the industry-standard H.264 compression to deliver high-quality, smooth videos and dual stream capability for remote viewing. A SATA hard-drive interface offers upgradability and VGA output allows users to connect to any TV or monitor with VGA input for viewing.

Local control of the system utilizes a mouse and graphical user interface (GUI) as well as a remote control. Users can also remotely monitor and control their system using a web browser or select mobile device.

This DVR uses cutting-edge technology without compromising stability and reliability making it ideal for home use as well as in warehouse, factory, retail and other similar environments.

## COMPRESSION FORMAT

Standard H.264 compression with low bit rate and high image quality

## LIVE SURVEILLANCE

Supports VGA output

Supports channel security by hiding live display

Displays the local record state and basic information

Supports full control with USB mouse

Supports digital zoom on live and playback view

## RECORDING MEDIA

Supports SATA hard disk drives up to 2TB each for longer recording times.

## BACKUP

Supports backing up to USB 2.0 devices

Some models support eSATA external hard drives

Supports saving recorded files with AVI format to a remote computer through internet

## RECORDING & PLAYBACK

Record modes: Manual, Schedule, Motion detection and Sensor alarm recording

Supports recycle after HDD is full

Resolution, frame rate and picture quality are adjustable

128MB for every video file packaging

Up to 16 audio channels available depending on model

Two record search modes: time search and event search

Supports multi-screen simultaneous playback

Supports deleting and locking the recorded files one by one

Supports remote playback in Network Client through LAN or internet

Supports recording in CIF and D1 resolutions.

## ALARM

1-4 channel alarm output and up to 16-channel (depending on model ) alarm input available

Supports scheduling for motion detection and sensor alarm

Supports pre-recording and post recording

Supports linked channels recording once motion or alarm is triggered on designated channel

Supports linked PTZ preset, and auto cruise

## PTZ CONTROL

Supports multiple PTZ protocols (PelcoP, PelcoD, LILIN, MINKING, NEON, STAR, VIDO, DSCP, VISCA, and RANGE)

Supports 128 PTZ presets and 8 auto cruise tracks

Supports remote PTZ control through internet

## SECURITY

Customize user rights: log search, system setup, two way audio, file management, disk management, remote login, live view, manual record, playback, PTZ control and remote live view

Supports 1 administrator and 15 users.

Supports event log recording and checking, events unlimited

## NETWORK

Supports TCP/IP, DHCP, PPPoE, DDNS

Supports Internet Explorer and Safari browsers to do remote viewing

Supports a maximum of 10 user connections simultaneously

Supports dual stream. Network stream is adjustable independently to fit the network bandwidth and environment.

Supports picture snap and color adjustment in remote live view

Supports remote time and event search, and channel playback with picture snap

Supports remote PTZ control with preset and auto cruise

Supports remote full menu setup, changing all the DVR parameters remotely

Supports mobile surveillance by smart phones, Win Mobile Pro, Win 7 Mobile, Symbian, and iPhones, iPads, Android, and Blackberry on 3G networks

Supports CMS to manage multiple devices over the internet

Administrator can limit user access to specific cameras

Administrator can disconnect online users



**NOTE!** Depending on your point of purchase, your DVR may have the hard disk drive already installed. If your drive was packaged separately or if you wish to upgrade to up to a 2TB drive, please see **Chapter 9** at the back of this manual which covers installing the drive.

# CONNECTIONS AND CONTROLS CHAPTER 2

You may view this DVR using a standard 19" (or larger) VGA monitor or a television. The former is connected using the VGA port on the back panel while the television utilizes the BNC "Video Out" port on the back. Your DVR is configured to use the VGA port as the main display. To use a TV, you will need to press and hold the STOP/ESC, EXIT or VGA/TV button (depending on model) for approximately 10 seconds until you hear a beep indicating that the video mode has been switched. A display connected to the other port will not show the menu.

## 2.1 DVR FUNCTIONS AND CONNECTIONS

### QT2124

#### FRONT PANEL

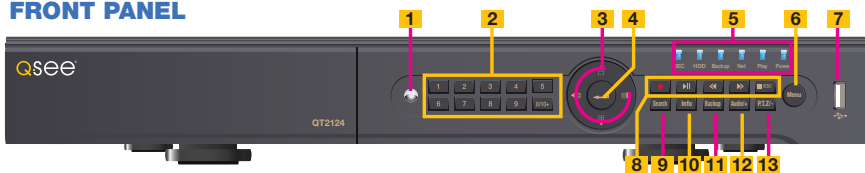

ITEM	NAME	FUNCTION
1	IR RECEIVER	Receives signals from remote control
2	NUMBER BUTTONS	Select individual channels for full screen view
3	DIRECTION	Selects multi-screen viewing mode Navigates through selections in menus
4	ENTER	Confirm Selection
5	INDICATOR LIGHTS	Shows status of the DVR Functions and the Hard Drive
6	MENU	Opens the Main Menu Increases the value in Setup mode
7	USB PORT	Used for external USB backup devices.
8	PLAYBACK CONTROLS	In addition to normal DVR playback and record operation, the following have additional functions: <b>RECORD</b> Controls Focus in PTZ mode <b>REVERSE</b> Controls Speed in PTZ mode <b>STOP/ESC</b> Exits current interface or status Also switches video output mode.
9	SEARCH/ZOOM	Enter Search mode Controls Zoom function in PTZ mode
10	INFO	Displays system information
11	BACKUP	Enter Backup mode Decreases the value in Setup mode
12	AUDIO	Mutes or unmutes audio
13	PTZ	Enter PTZ mode

#### BACK PANEL

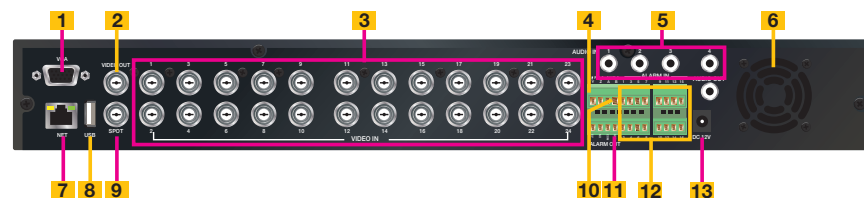

ITEM	NAME	FUNCTION
1	VGA PORT	VGA output for 19" or larger monitor
2	VIDEO OUT	BNC connector for TV or monitor
3	VIDEO IN	BNC connectors for up to 24 cameras
4	PTZ	Connections for Pan-Tilt-Zoom speed dome cameras. Y = "+" Z = "-"
5	AUDIO IN	4 channels of audio input
6	FAN	Cooling fan exhaust port. This should not be blocked.
7	NET	Network (ethernet) port
8	USB PORT	For the USB mouse
9	K/B	Connector for a PTZ keyboard
10	SPOT OUT	Connect to another monitor as an auxiliary output channel. This monitor will only display video and will have no menu access.
11	ALARM OUT	1 Channel relay output for external alarm
12	ALARM IN	Connections for up to 16 external sensors
13	DC IN	Power input for 12V DC power supply

## QT454 FRONT PANEL

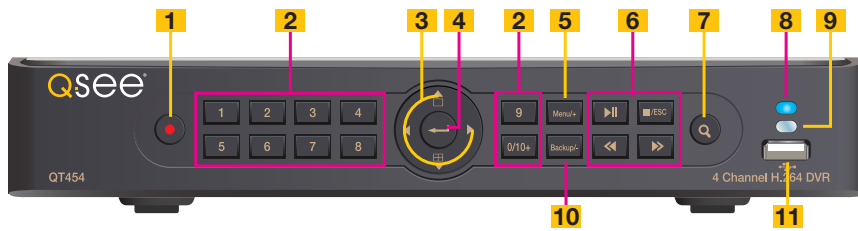

ITEM	NAME	FUNCTION
1	<b>POWER</b>	Power On/Off
2	<b>NUMBER BUTTONS</b>	Select individual channels and enter data where required
3	<b>DIRECTION</b>	Navigates through selections in menus Selects viewing mode - Full Screen or 4-Channel Multi-Screen View
4	<b>ENTER</b>	Confirm Selection
5	<b>MENU</b>	Opens the Main Menu Increases the value in Setup mode
6	<b>PLAYBACK CONTROLS</b>	In addition to normal DVR playback and record operation, the following have additional functions: RECORD Controls Focus in PTZ mode REVERSE Controls Speed in PTZ mode STOP/ESC Exits current interface or status Also switches video output mode.
7	<b>SEARCH/ ZOOM</b>	Enter Search mode Controls Zoom function in PTZ mode
8	<b>INDICATOR LIGHT</b>	Shows power status of the DVR
9	<b>INFRARED WINDOW</b>	Receives signals from the remote control
10	<b>BACKUP</b>	Enter Backup mode Decreases the value in Setup mode
11	<b>USB PORT</b>	Used for external USB backup devices.

## REAR PANEL

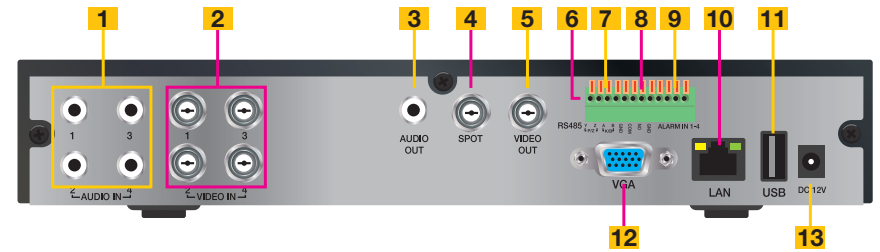

ITEM	NAME	FUNCTION
1	<b>AUDIO IN</b>	4 Channels of audio input
2	<b>VIDEO IN</b>	Video input from up to 4 cameras
3	<b>AUDIO OUT</b>	Audio output for amplified speaker
4	<b>SPOT OUT</b>	Connect to another monitor as an auxiliary output channel. This monitor will only display video and will have no menu access.
5	<b>VIDEO OUT</b>	BNC connector for TV or monitor
6	<b>PTZ</b>	Connections for Pan-Tilt-Zoom speed dome cameras. Y = "+" Z = "-"
7	<b>K/B</b>	Connector for a PTZ keyboard
8	<b>ALARM OUT</b>	1 Channel relay output for external alarms
9	<b>ALARM IN</b>	4 Channel input for external sensors and alarms
10	<b>LAN</b>	Network (ethernet) port
11	<b>USB PORT</b>	For the USB mouse
12	<b>VGA PORT</b>	VGA output for 19" or larger monitor
13	<b>DC IN</b>	Power input for 12V DC power supply

## QT474

### FRONT PANEL



ITEM	NAME	FUNCTION
1	INDICATOR LIGHTS	Shows the recording, network and power status of the DVR.
2	INFRARED WINDOW	Receives signals from the remote control
3	VIDEO MODE BUTTON	Press and hold 10 seconds (or until you hear a beep) to switch video output from the VGA port (default) to the BNC video out port.
4	USB PORT	Used for external USB backup devices.

### REAR PANEL

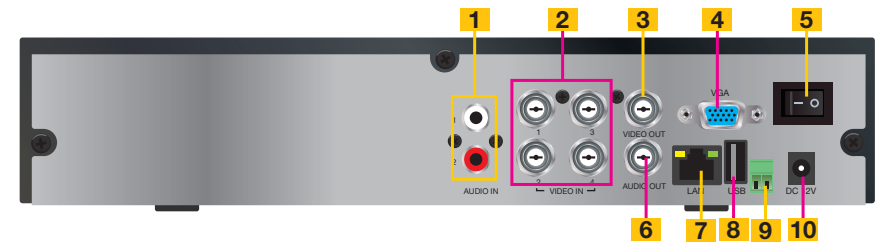

ITEM	NAME	FUNCTION
1	AUDIO IN	2 Channels of audio input
2	VIDEO IN	Video input from up to 4 cameras
3	VIDEO OUT	BNC connector for TV or monitor
4	VGA PORT	VGA output for 19" or larger monitor
5	POWER SWITCH	Use to turn on the DVR as well as to turn off after powering down from within the GUI
6	AUDIO OUT	BNC Audio output for amplified speaker
7	LAN	Network (ethernet) port
8	USB PORT	For the USB mouse
9	PTZ	Connections for Pan-Tilt-Zoom speed dome cameras.
10	DC IN	Power input for 12V DC power supply



## QT426

### FRONT PANEL

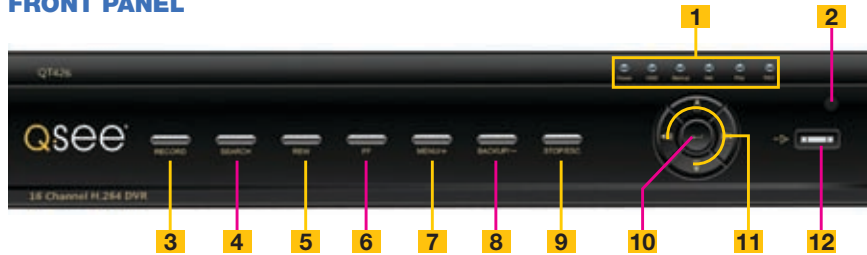

ITEM	NAME	FUNCTION
1	<b>LED INDICATORS</b>	Show status of power, HDD, record, etc.
2	<b>IR RECEIVER</b>	Receives signals from remote control
3	<b>RECORD</b>	Manually begins recording
4	<b>PLAY</b>	Launches PLAYBACK window
5	<b>REW</b>	Rewind key
6	<b>FF</b>	Fast Forward
7	<b>+ / MENU</b>	Increase the value in SETUP/Enter menu in LIVE VIEW
8	<b>- / BACKUP</b>	Decrease the value in SETUP/Enter backup mode in LIVE VIEW
9	<b>STOP / ESC</b>	Quit PLAYBACK mode/Exit the current window or status Also switches video output mode.
10	<b>ENTER</b>	Confirm selection
11	<b>DIRECTION / MULTISCREEN</b>	1. Navigate through on-screen options 2. Change screen display mode between 1, 4, 9 and 16 channels
12	<b>USB</b>	USB port to connect USB flash or external hard drives to update firmware or back up recordings

### REAR PANEL

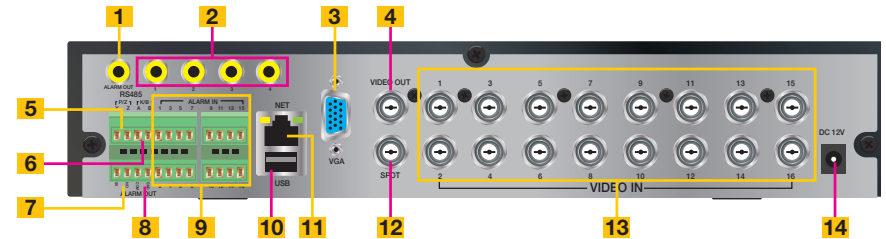

ITEM	NAME	FUNCTION
1	<b>AUDIO OUTPUT</b>	Connection for audio output – connect to an amplified speaker
2	<b>AUDIO IN</b>	4-Channel audio input for cameras equipped with audio
3	<b>VGA PORT</b>	Video output for connecting to monitor
4	<b>VIDEO OUT</b>	Video output for connecting to TV (BNC) or monitor
5	<b>RS485</b>	Connect to Pan-Tilt-Zoom camera to control motion
6	<b>K/B</b>	Connect to keyboard
7	<b>ALARM OUTPUT</b>	Output for alarm
8	<b>+5 AND GND</b>	+5 and grounding
9	<b>ALARM IN</b>	Connect to up to sixteen external sensors
10	<b>USB PORT</b>	Connect USB mouse
11	<b>NET</b>	Network (ethernet) port
12	<b>SPOT</b>	Connect to another monitor as an auxiliary output channel. This monitor will only display video and will have no menu access.
13	<b>VIDEO IN</b>	Video input from up to 16 cameras
14	<b>DC +12V</b>	Power input

## QT428

### FRONT PANEL

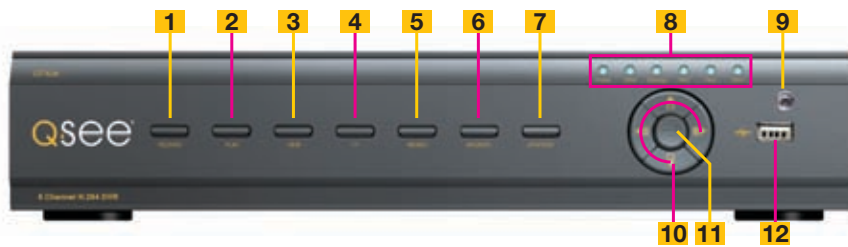

ITEM	NAME	FUNCTION
1	<b>RECORD</b>	Manually begins recording
2	<b>PLAY</b>	Launches PLAYBACK window
3	<b>REW</b>	Rewind
4	<b>FF</b>	Fast Forward
5	<b>+ / MENU</b>	Increase the value in SETUP / Enter menu in LIVE VIEW
6	<b>- / BACKUP</b>	Decrease the value in SETUP / Enter backup mode in LIVE VIEW
7	<b>STOP / ESC</b>	Quit PLAYBACK mode / Exit the current window or status Also switches video output mode.
8	<b>LED INDICATORS</b>	Show status of power, HDD, record, etc.
9	<b>IR RECEIVER</b>	Receives signals from remote control
10	<b>DIRECTION / MULTISCREEN</b>	1. Navigate through on-screen options 2. Change screen display mode between 1, 4, and 9 channels
11	<b>ENTER</b>	Confirm selection
12	<b>USB</b>	USB port to connect USB flash or external hard drives to update firmware or back up recordings

### REAR PANEL

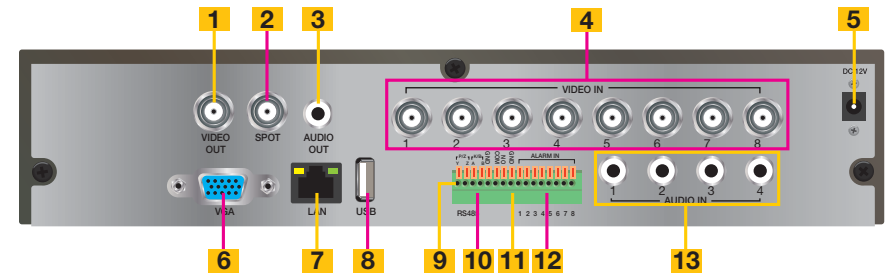

ITEM	NAME	FUNCTION
1	<b>VIDEO OUT</b>	Video output for connecting to TV (BNC) or monitor
2	<b>SPOT</b>	Connect to another monitor as an auxiliary output channel. This monitor will only display video and will have no menu access.
3	<b>AUDIO OUTPUT</b>	Connection for audio output – connect to an amplified speaker
4	<b>VIDEO IN</b>	Video input from up to 8 cameras
5	<b>DC +12V</b>	Power input
6	<b>VGA PORT</b>	Video output for connecting to monitor
7	<b>LAN</b>	Network (ethernet) port
8	<b>USB PORT</b>	Connect USB mouse
9	<b>RS485</b>	Connect to Pan-Tilt-Zoom camera to control motion
10	<b>K/B</b>	Connect to keyboard
11	<b>ALARM OUTPUT</b>	Output for alarm
12	<b>ALARM IN</b>	Connect to up to eight external sensors
13	<b>AUDIO IN</b>	4-Channel audio input for cameras equipped with audio

## QT446

### FRONT PANEL

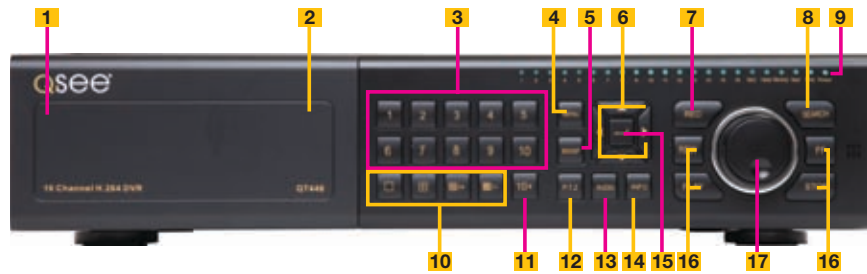

ITEM	NAME	FUNCTION
1	<b>POWER</b> (Behind flip-down panel)	Puts the DVR into standby mode or wakes it up from standby mode.
2	<b>USB PORT</b> (Behind flip-down panel)	Used for external USB backup devices.
3	<b>NUMBER PAD</b>	Enter channel numbers.
4	<b>MENU</b>	Opens the Main Menu
5	<b>BACKUP</b>	Opens Backup Menu
6	<b>DIRECTION</b>	Navigates through selections in menus
7	<b>RECORD</b>	Begins manually recording on all channels
8	<b>SEARCH</b>	Enters Search Mode
9	<b>INDICATOR LIGHTS</b>	Shows status of the DVR Functions and the Hard Drive
10	<b>VIEWING MODE</b>	Change between 1, 4, 8 and 16-screen viewing mode
11	<b>10+ BUTTON</b>	Input channels numbers above 10 by pushing this button followed by the second digit.
12	<b>PTZ</b>	Enter PTZ mode in live view
13	<b>AUDIO</b>	Turn audio on or off in live view if audio input devices are attached.
14	<b>INFO</b>	Displays system information
15	<b>ENTER</b>	Confirms selection in menus or input in fields
16	<b>PLAYBACK CONTROLS</b>	<b>REW</b> - Rewind <b>PLAY</b> - Opens the Playback interface. Pauses or resumes playback <b>FF</b> - Fast Forward <b>STOP</b> - Quits Playback mode Also switches video output mode.
17	<b>CONTROL KNOB</b>	Outer ring navigates through menus Inner knob increases or decreases speed of fast forward or rewind.

### BACK PANEL

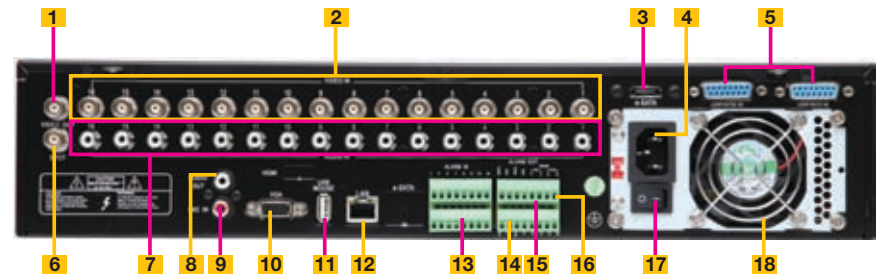

ITEM	NAME	FUNCTION
1	<b>VIDEO OUT</b>	BNC connector for TV or monitor
2	<b>VIDEO IN</b>	BNC connectors for up to 16 cameras
3	<b>eSATA (2)</b>	Connection for external eSATA hard drive for backup
4	<b>POWER SOCKET</b>	Attachment point for power cord
5	<b>LOOP OUT (2)</b>	Output each channel to a separate monitor. Each port handles 8 channels.
6	<b>SPOT OUT</b>	Connect to another monitor as an auxiliary output channel. This monitor will only display video and will have no menu access.
7	<b>AUDIO IN</b>	16 channels of audio input
8	<b>AUDIO OUT</b>	Audio output for amplified speaker
9	<b>MICROPHONE IN</b>	Connect a microphone for two-way audio
10	<b>VGA PORT</b>	VGA output for 19" or larger monitor
11	<b>USB PORT</b>	For the USB mouse
12	<b>LAN</b>	Network (ethernet) port
13	<b>ALARM IN</b>	Connect up to 16 external sensors
14	<b>ALARM OUT</b>	4 Channel relay output for external alarms
15	<b>PTZ</b>	Connections for Pan-Tilt-Zoom speed dome cameras. Y = "+" Z = "-"
16	<b>K/B</b>	Connector for a PTZ keyboard
17	<b>POWER SWITCH</b>	Use to turn on the DVR as well as to turn off after powering down from within the GUI
18	<b>FAN</b>	Cooling fan exhaust port. This should not be blocked.

## QT4332 QT4532

### FRONT PANEL

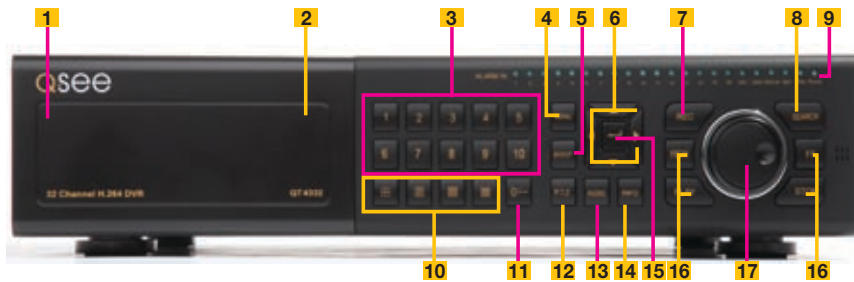

ITEM	NAME	FUNCTION
1	<b>POWER</b> (Behind flip-down panel)	Puts the DVR into standby mode or wakes it up from standby mode.
2	<b>USB PORT</b> (Behind flip-down panel)	Used for external USB backup devices.
3	<b>NUMBER PAD</b>	Enter channel numbers.
4	<b>MENU</b>	Opens the Main Menu
5	<b>BACKUP</b>	Opens Backup Menu
6	<b>DIRECTION</b>	Navigates through selections in menus
7	<b>RECORD</b>	Begins manually recording on all channels
8	<b>SEARCH</b>	Enters Search Mode
9	<b>INDICATOR LIGHTS</b>	Shows status of the DVR Functions and the Hard Drive
10	<b>VIEWING MODE</b>	Change between 1, 4, 8, 16 and 32-screen viewing mode
11	<b>10+ BUTTON</b>	Input channels numbers above 10 by pushing this button followed by the second digit.
12	<b>PTZ</b>	Enter PTZ mode in live view
13	<b>AUDIO</b>	Turn audio on or off in live view if audio input devices are attached.
14	<b>INFO</b>	Displays system information
15	<b>ENTER</b>	Confirms selection in menus or input in fields
16	<b>PLAYBACK CONTROLS</b>	<b>REW</b> - Rewind <b>PLAY</b> - Opens the Playback interface. Pauses or resumes playback <b>FF</b> - Fast Forward <b>STOP</b> - Quits Playback mode Also switches video output mode.
17	<b>CONTROL KNOB</b>	Outer ring navigates through menus Inner knob increases or decreases speed of fast forward or rewind.

### BACK PANEL

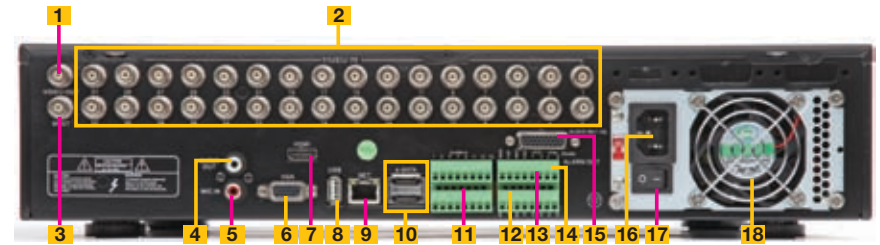

ITEM	NAME	FUNCTION
1	<b>VIDEO OUT</b>	BNC connector for TV or monitor
2	<b>VIDEO IN</b>	BNC connectors for up to 32 cameras
3	<b>SPOT OUT</b>	Connect to another monitor as an auxiliary output channel. This monitor will only display video and will have no menu access.
4	<b>AUDIO OUT</b>	Audio output for amplified speaker
5	<b>MICROPHONE IN</b>	Connect a microphone for two-way audio
6	<b>VGA PORT</b>	VGA output for 19" or larger monitor
7	<b>HDMI</b>	HDMI video output
8	<b>USB PORT</b>	For the USB mouse
9	<b>LAN</b>	Network (ethernet) port
10	<b>eSATA (2)</b>	Connection for external eSATA hard drive for backup
11	<b>ALARM IN</b>	Connect up to 16 external sensors
12	<b>ALARM OUT</b>	4 Channel relay output for external alarms
13	<b>PTZ</b>	Connections for Pan-Tilt-Zoom speed dome cameras. Y = "+" Z = "-"
14	<b>K/B</b>	Connector for a PTZ keyboard
15	<b>AUDIO IN</b>	Attachment point for audio dongle which allows up to 16 channels of audio input.
16	<b>POWER SOCKET</b>	Attachment point for power cord
17	<b>POWER SWITCH</b>	Use to turn on the DVR as well as to turn off after powering down from within the GUI
18	<b>FAN</b>	Cooling fan exhaust port. This should not be blocked.

## QT504

### FRONT PANEL

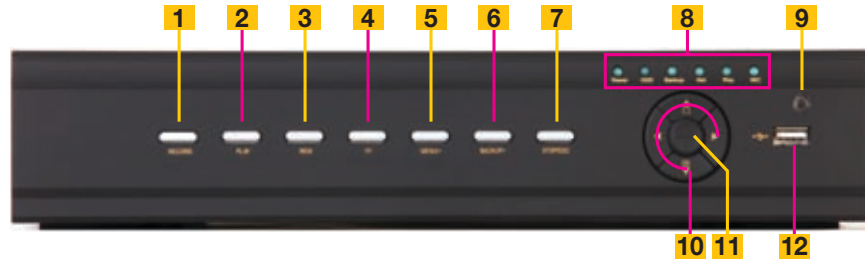

ITEM	NAME	FUNCTION
1	<b>RECORD</b>	Begins manual recording Controls Focus in PTZ mode
2	<b>PLAY</b>	Begins playback
3	<b>REWIND</b>	Rewinds video Controls camera speed in PTZ mode
4	<b>FAST FORWARD</b>	Advances playback speed
5	<b>MENU/+</b>	Opens the Main Menu Increases the value in Setup mode
6	<b>BACKUP/-</b>	Opens Backup Menu Decreases the value in Setup mode
7	<b>STOP/ESC</b>	Ends video playback. Exits current interface or status Switches video output mode.
8	<b>INDICATOR LIGHTS</b>	Shows status of the DVR Functions and the Hard Drive
9	<b>IR RECEIVER</b>	Receives signals from remote control
10	<b>DIRECTION</b>	Selects multi-screen viewing mode Navigates through selections in menus
11	<b>RETURN</b>	Confirms selection
12	<b>USB PORT</b>	Used for external USB backup devices.

### BACK PANEL

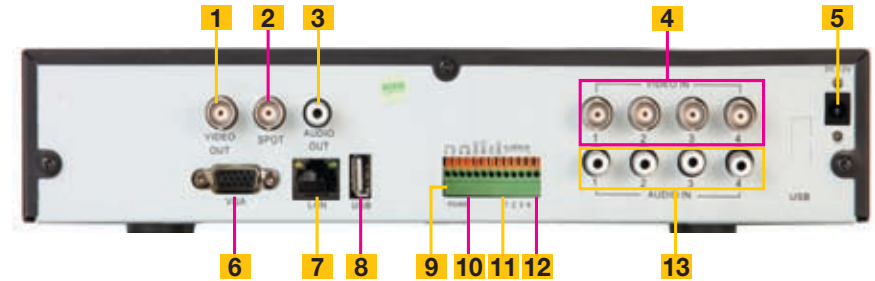

ITEM	NAME	FUNCTION
1	<b>VIDEO OUT</b>	BNC connector for TV or monitor
2	<b>SPOT OUT</b>	Connect to another monitor as an auxiliary output channel. This monitor will only display video and will have no menu access.
3	<b>AUDIO OUT</b>	Audio output for amplified speaker
4	<b>VIDEO IN</b>	BNC connectors for up to 4 cameras
5	<b>DC IN</b>	Power input for 12V DC power supply
6	<b>VGA PORT</b>	VGA output for 19" or larger monitor
7	<b>NET</b>	Network (ethernet) port
8	<b>USB PORT</b>	For the USB mouse
9	<b>PTZ</b>	Connections for Pan-Tilt-Zoom speed dome cameras. Y = "+" Z = "-"
10	<b>K/B</b>	Connector for a PTZ keyboard
11	<b>+5V and GND</b>	+5V and grounding
12	<b>ALARM IN/OUT</b>	4 Channel input and output for external sensors and alarms
13	<b>AUDIO IN</b>	4 channels of audio input

## QT526

### FRONT PANEL

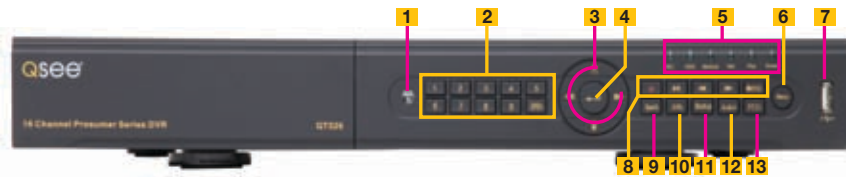

ITEM	NAME	FUNCTION
1	<b>IR RECEIVER</b>	Receives signals from remote control
2	<b>NUMBER BUTTONS</b>	Select individual channels for full screen view
3	<b>DIRECTION</b>	Selects multi-screen viewing mode Navigates through selections in menus
4	<b>ENTER</b>	Confirm Selection
5	<b>INDICATOR LIGHTS</b>	Shows status of the DVR Functions and the Hard Drive
6	<b>MENU</b>	Opens the Main Menu Increases the value in Setup mode
7	<b>USB PORT</b>	Used for external USB backup devices.
8	<b>PLAYBACK CONTROLS</b>	In addition to normal DVR playback and record operation, the following have additional functions: <b>RECORD</b> Controls Focus in PTZ mode <b>REVERSE</b> Controls Speed in PTZ mode <b>STOP/ESC</b> Exits current interface or status Also switches video output mode.
9	<b>SEARCH/ZOOM</b>	Enter Search mode Controls Zoom function in PTZ mode
10	<b>INFO</b>	Displays system information
11	<b>BACKUP</b>	Enter Backup mode Decreases the value in Setup mode
12	<b>AUDIO</b>	Mutes or unmutes audio
13	<b>PTZ</b>	Enter PTZ mode

### BACK PANEL



ITEM	NAME	FUNCTION
1	<b>PTZ</b>	Connections for Pan-Tilt-Zoom speed dome cameras. Y = "+" Z = "-"
2	<b>K/B</b>	Connector for a PTZ keyboard
3	<b>ALARM IN</b>	Connections for up to 16 external sensors
4	<b>NET</b>	Network (ethernet) port
5	<b>VGA PORT</b>	VGA output for 19" or larger monitor
6	<b>VIDEO OUT</b>	BNC connector for TV or monitor
7	<b>VIDEO IN</b>	BNC connectors for up to 16 cameras
8	<b>AUDIO IN</b>	4 channels of audio input
9	<b>AUDIO OUT</b>	Audio output for amplified speaker
10	<b>POWER</b>	Power On/Off
11	<b>+5V and GND</b>	+5V and grounding
12	<b>ALARM OUT</b>	1 Channel relay output for external alarm
13	<b>USB PORT</b>	For the USB mouse
14	<b>SPOT OUT</b>	Connect to another monitor as an auxiliary output channel. This monitor will only display video and will have no menu access.
15	<b>DC IN</b>	Power input for 12V DC power supply
16	<b>FAN</b>	Cooling fan exhaust port. This should not be blocked.

## QT528

### FRONT PANEL

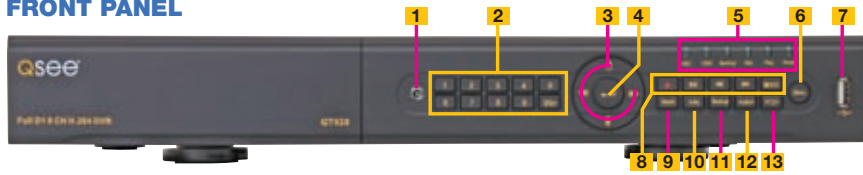

ITEM	NAME	FUNCTION
1	IR RECEIVER	Receives signals from remote control
2	NUMBER BUTTONS	Select individual channels for full screen view
3	DIRECTION	Selects multi-screen viewing mode Navigates through selections in menus
4	ENTER	Confirm Selection
5	INDICATOR LIGHTS	Shows status of the DVR Functions and the Hard Drive
6	MENU	Opens the Main Menu Increases the value in Setup mode
7	USB PORT	Used for external USB backup devices.
8	PLAYBACK CONTROLS	In addition to normal DVR playback and record operation, the following have additional functions: <b>RECORD</b> Controls Focus in PTZ mode <b>REVERSE</b> Controls Speed in PTZ mode <b>STOP/ESC</b> Exits current interface or status Also switches video output mode.
9	SEARCH/ZOOM	Enter Search mode Controls Zoom function in PTZ mode
10	INFO	Displays system information
11	BACKUP	Enter Backup mode Decreases the value in Setup mode
12	AUDIO	Mutes or unmutes audio
13	PTZ	Enter PTZ mode

### BACK PANEL



ITEM	NAME	FUNCTION
1	PTZ	Connections for Pan-Tilt-Zoom speed dome cameras. Y = "+" Z = "-"
2	K/B	Connector for a PTZ keyboard
3	ALARM IN	Connections for up to 8 external sensors
4	NET	Network (ethernet) port
5	VGA PORT	VGA output for 19" or larger monitor
6	VIDEO OUT	BNC connector for TV or monitor
7	VIDEO IN	BNC connectors for up to 8 cameras
8	AUDIO IN	4 channels of audio input
9	AUDIO OUT	Audio output for amplified speaker
10	POWER	Power On/Off
11	+5V and GND	+5V and grounding
12	ALARM OUT	1 Channel relay output for external alarm
13	USB PORT	For the USB mouse
14	SPOT OUT	Connect to another monitor as an auxiliary output channel. This monitor will only display video and will have no menu access.
15	DC IN	Power input for 12V DC power supply
16	FAN	Cooling fan exhaust port. This should not be blocked.

## QT518

### FRONT PANEL

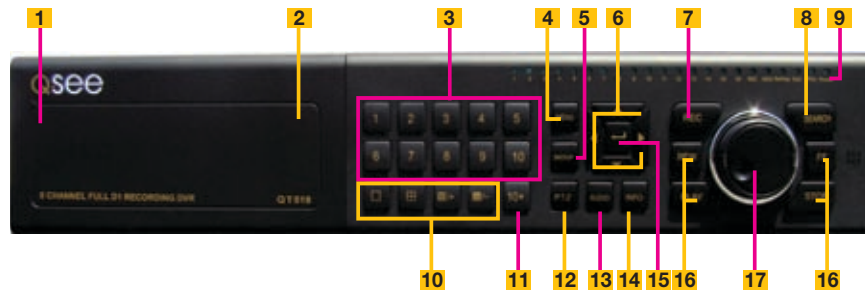

ITEM	NAME	FUNCTION
1	<b>POWER</b> (Behind flip-down panel)	Puts the DVR into standby mode or wakes it up from standby mode.
2	<b>USB PORT</b> (Behind flip-down panel)	Used for external USB backup devices.
3	<b>NUMBER PAD</b>	Enter channel numbers.
4	<b>MENU</b>	Opens the Main Menu
5	<b>BACKUP</b>	Opens Backup Menu
6	<b>DIRECTION</b>	Navigates through selections in menus
7	<b>RECORD</b>	Begins manually recording on all channels
8	<b>SEARCH</b>	Enters Search Mode
9	<b>INDICATOR LIGHTS</b>	Shows status of the DVR Functions and the Hard Drive
10	<b>VIEWING MODE</b>	Change between 1, 4, and 8-screen viewing mode
11	<b>10+ BUTTON</b>	Input channels numbers above 10 by pushing this button followed by the second digit.
12	<b>PTZ</b>	Enter PTZ mode in live view
13	<b>AUDIO</b>	Turn audio on or off in live view if audio input devices are attached.
14	<b>INFO</b>	Displays system information
15	<b>ENTER</b>	Confirms selection in menus or input in fields
16	<b>PLAYBACK CONTROLS</b>	<b>REW</b> - Rewind <b>PLAY</b> - Opens the Playback interface. Pauses or resumes playback <b>FF</b> - Fast Forward <b>STOP</b> - Quits Playback mode Also switches video output mode.
17	<b>CONTROL KNOB</b>	Outer ring navigates through menus Inner knob increases or decreases speed of fast forward or rewind.

### BACK PANEL

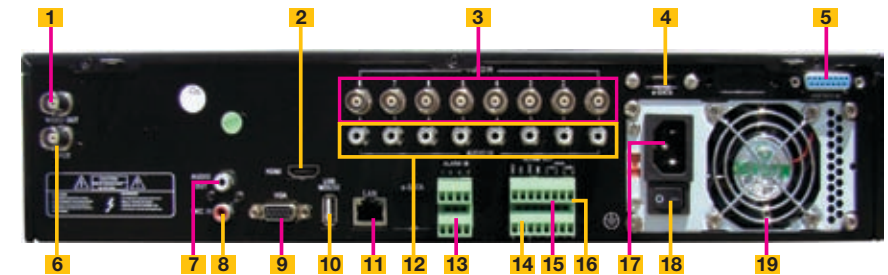

ITEM	NAME	FUNCTION
1	<b>VIDEO OUT</b>	BNC connector for TV or monitor
2	<b>HDMI</b>	HDMI video output
3	<b>VIDEO IN</b>	BNC connectors for up to 8 cameras
4	<b>eSATA</b>	Connection for external eSATA hard drive for backup
5	<b>LOOP OUT</b>	Output each channel to a separate monitor
6	<b>SPOT OUT</b>	Connect to another monitor as an auxiliary output channel. This monitor will only display video and will have no menu access.
7	<b>AUDIO OUT</b>	Audio output for amplified speaker
8	<b>MICROPHONE IN</b>	Connect a microphone for two-way audio
9	<b>VGA PORT</b>	VGA output for 19" or larger monitor
10	<b>USB PORT</b>	For the USB mouse
11	<b>LAN</b>	Network (ethernet) port
12	<b>AUDIO IN</b>	8 channels of audio input
13	<b>ALARM IN</b>	Connect up to 8 external sensors
14	<b>ALARM OUT</b>	4 Channel relay output for external alarms
15	<b>PTZ</b>	Connections for Pan-Tilt-Zoom speed dome cameras. Y = "+" Z = "-"
16	<b>K/B</b>	Connector for a PTZ keyboard
17	<b>POWER SOCKET</b>	Attachment point for power cord
18	<b>POWER SWITCH</b>	Use to turn on the DVR as well as to turn off after powering down from within the GUI
19	<b>FAN</b>	Cooling fan exhaust port. This should not be blocked.



## QT5116

### FRONT PANEL

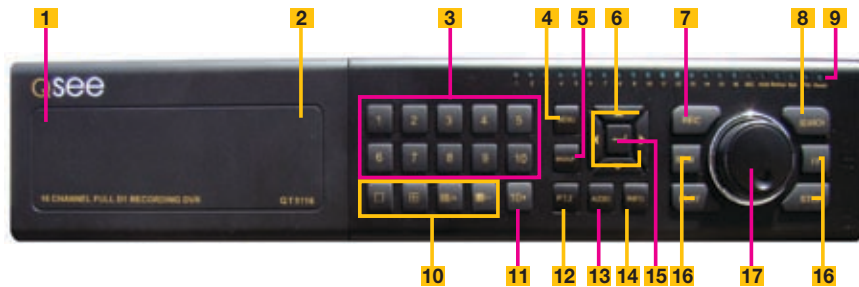

ITEM	NAME	FUNCTION
1	<b>POWER</b> (Behind flip-down panel)	Puts the DVR into standby mode or wakes it up from standby mode.
2	<b>USB PORT</b> (Behind flip-down panel)	Used for external USB backup devices.
3	<b>NUMBER PAD</b>	Enter channel numbers.
4	<b>MENU</b>	Opens the Main Menu
5	<b>BACKUP</b>	Opens Backup Menu
6	<b>DIRECTION</b>	Navigates through selections in menus
7	<b>RECORD</b>	Begins manually recording on all channels
8	<b>SEARCH</b>	Enters Search Mode
9	<b>INDICATOR LIGHTS</b>	Shows status of the DVR Functions and the Hard Drive
10	<b>VIEWING MODE</b>	Change between 1, 4, 8 and 16-screen viewing mode
11	<b>10+ BUTTON</b>	Input channels numbers above 10 by pushing this button followed by the second digit.
12	<b>PTZ</b>	Enter PTZ mode in live view
13	<b>AUDIO</b>	Turn audio on or off in live view if audio input devices are attached.
14	<b>INFO</b>	Displays system information
15	<b>ENTER</b>	Confirms selection in menus or input in fields
16	<b>PLAYBACK CONTROLS</b>	<b>REW</b> - Rewind <b>PLAY</b> - Opens the Playback interface. Pauses or resumes playback <b>FF</b> - Fast Forward <b>STOP</b> - Quits Playback mode Also switches video output mode.
17	<b>CONTROL KNOB</b>	Outer ring navigates through menus Inner knob increases or decreases speed of fast forward or rewind.

### BACK PANEL

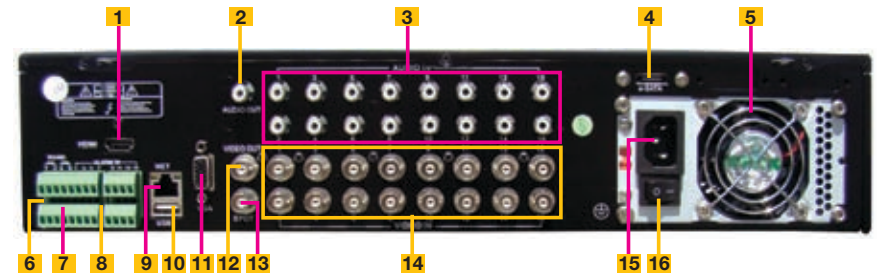

ITEM	NAME	FUNCTION
1	<b>HDMI</b>	HDMI video output
2	<b>AUDIO OUT</b>	Audio output for amplified speaker
3	<b>AUDIO IN</b>	16 channels of audio input
4	<b>eSATA</b>	Connection for external eSATA hard drive for backup
5	<b>FAN</b>	Cooling fan exhaust port. This should not be blocked.
6	<b>PTZ</b>	Connections for Pan-Tilt-Zoom speed dome cameras. Y = "+" Z = "-"
7	<b>K/B</b>	Connector for a PTZ keyboard
8	<b>ALARM IN</b>	Connect up to 16 external sensors
9	<b>LAN</b>	Network (ethernet) port
10	<b>USB PORT</b>	For the USB mouse
11	<b>VGA PORT</b>	VGA output for 19" or larger monitor
12	<b>VIDEO OUT</b>	BNC connector for TV or monitor
13	<b>SPOT OUT</b>	Connect to another monitor as an auxiliary output channel. This monitor will only display video and will have no menu access.
14	<b>VIDEO IN</b>	BNC connectors for up to 16 cameras
15	<b>POWER SOCKET</b>	Attachment point for power cord
16	<b>POWER SWITCH</b>	Use to turn on the DVR as well as to turn off after powering down from within the GUI

## QT536

### FRONT PANEL

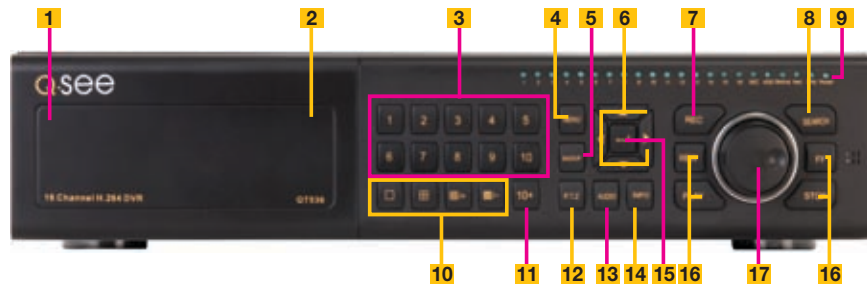

ITEM	NAME	FUNCTION
1	<b>POWER</b> (Behind flip-down panel)	Puts the DVR into standby mode or wakes it up from standby mode.
2	<b>USB PORT</b> (Behind flip-down panel)	Used for external USB backup devices.
3	<b>NUMBER PAD</b>	Enter channel numbers.
4	<b>MENU</b>	Opens the Main Menu
5	<b>BACKUP</b>	Opens Backup Menu
6	<b>DIRECTION</b>	Navigates through selections in menus
7	<b>RECORD</b>	Begins manually recording on all channels
8	<b>SEARCH</b>	Enters Search Mode
9	<b>INDICATOR LIGHTS</b>	Shows status of the DVR Functions and the Hard Drive
10	<b>VIEWING MODE</b>	Change between 1, 4, 8 and 16-screen viewing mode
11	<b>10+ BUTTON</b>	Input channels numbers above 10 by pushing this button followed by the second digit.
12	<b>PTZ</b>	Enter PTZ mode in live view
13	<b>AUDIO</b>	Turn audio on or off in live view if audio input devices are attached.
14	<b>INFO</b>	Displays system information
15	<b>ENTER</b>	Confirms selection in menus or input in fields
16	<b>PLAYBACK CONTROLS</b>	<b>REW</b> - Rewind <b>PLAY</b> - Opens the Playback interface. Pauses or resumes playback <b>FF</b> - Fast Forward <b>STOP</b> - Quits Playback mode Also switches video output mode.
17	<b>CONTROL KNOB</b>	Outer ring navigates through menus Inner knob increases or decreases speed of fast forward or rewind.

### BACK PANEL

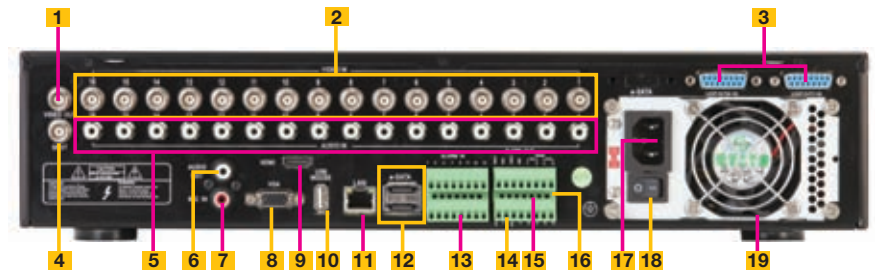

ITEM	NAME	FUNCTION
1	<b>VIDEO OUT</b>	BNC connector for TV or monitor
2	<b>VIDEO IN</b>	BNC connectors for up to 16 cameras
3	<b>LOOP OUT (2)</b>	Output each channel to a separate monitor. Each port handles 8 channels.
4	<b>SPOT OUT</b>	Connect to another monitor as an auxiliary output channel. This monitor will only display video and will have no menu access.
5	<b>AUDIO IN</b>	16 channels of audio input
6	<b>AUDIO OUT</b>	Audio output for amplified speaker
7	<b>MICROPHONE IN</b>	Connect a microphone for two-way audio
8	<b>VGA PORT</b>	VGA output for 19" or larger monitor
9	<b>HDMI</b>	HDMI video output
10	<b>USB PORT</b>	For the USB mouse
11	<b>LAN</b>	Network (ethernet) port
12	<b>eSATA (2)</b>	Connection for external eSATA hard drive for backup
13	<b>ALARM IN</b>	Connect up to 16 external sensors
14	<b>ALARM OUT</b>	4 Channel relay output for external alarms
15	<b>PTZ</b>	Connections for Pan-Tilt-Zoom speed dome cameras. Y = "+" Z = "-"
16	<b>K/B</b>	Connector for a PTZ keyboard
17	<b>POWER SOCKET</b>	Attachment point for power cord
18	<b>POWER SWITCH</b>	Use to turn on the DVR as well as to turn off after powering down from within the GUI
19	<b>FAN</b>	Cooling fan exhaust port. This should not be blocked.

In addition to the buttons on the front of the DVR, your system can be controlled through the USB mouse and the remote control. We have found that the majority of our customers prefer to operate their DVRs using the USB mouse because of its ease of use and flexibility and our manual is set up with this in mind.

## 2.2 MOUSE

The mouse is the default tool for navigating through the menus. Specific instructions for its use within a function appear in the appropriate sections of the manual, but a basic overview is below:

### In Live View:

Double-click the left button on any camera view in split-screen mode to bring it to full-screen display.

Double-click again to return to split-screen mode.

Right-click to show the control bar at the bottom of the screen.

Right-clicking again will hide the control bar.

### In Setup:

Left-click to make a selection. Right-click to cancel setup or return to previous screen.

### To Input Values:

Move the cursor to a blank field and click. A virtual keyboard will appear which supports numbers, letters and symbols. The Shift function will access symbols in addition to upper case letters.

Certain values, such as time settings, can be changed using the mouse wheel.

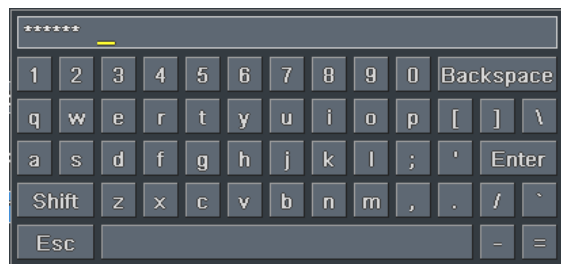

## 2.3 REMOTE CONTROL

The remote control allows you to perform most of the day-to-day functions from a convenient distance. It functions as a typical remote control with additional buttons allowing you to navigate through menus and control functions. We recommend that you configure your DVR using the mouse controls, reserving the remote control for operations such as live viewing, file search and playback.

It uses two AAA-sized batteries. If the remote's performance degrades, check the batteries as well as that the IR receiver window on the DVR is unobstructed.

Item	Button	Function
1	POWER	Soft power down switch. Use this before unplugging the DVR
2	INFO	Get information about the DVR such as HDD space and firmware version
3	REC	Begin recording
4	Numbers	Input numbers in fields or select camera
5	Multi-Screen	Choose multi-screen display mode
6	MENU	Opens <b>MENU</b> window
7	SEARCH	Enter <b>SEARCH</b> mode
8	Directional	Move cursor in set up or control PTZ camera
9	ENTER	Confirm choice or settings
10	SET +/-	Increase or decrease value in <b>SETUP</b> mode
11	Playback	Controls playback functions, including stop, single-frame, fast forward, etc.
12	AUDIO	Enable audio input in live mode
13	SEQ	Returns to auto dwell display sequence
14	BACKUP	Enters <b>BACKUP</b> menu
15	PTZ Controls	Controls PTZ camera including zoom, focus, iris and speed

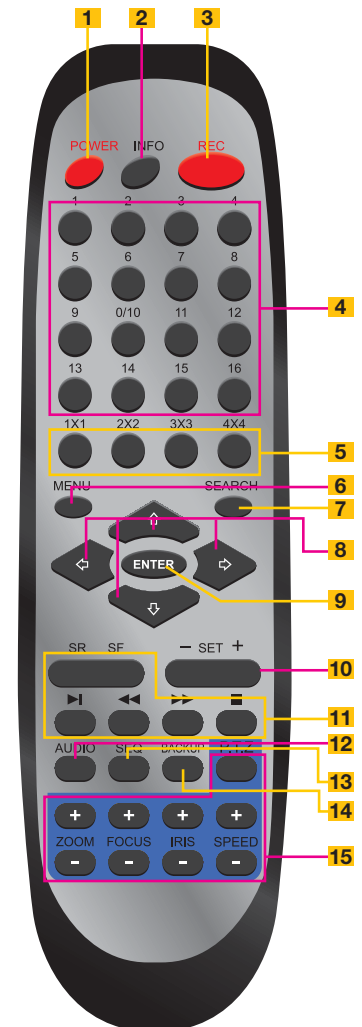

### 3.1 POWER ON/OFF

Before turning on the DVR, ensure that all connections are good.

#### POWER ON AND LOGIN

Connect the power supply and the DVR will power up. The LED labelled **POWER** on the front will illuminate and the DVR will display the live image from Channel 1.

Before you can proceed, you will need to log into the DVR.

**STEP 1.** Right-click with the mouse anywhere on the screen

**STEP 2.** Press the **MENU** button on the remote or press the **STOP/ESC** button on the front of the DVR to open the **Control Bar** which will appear at the bottom of the screen (**Picture 3-3**).

**STEP 3.** Once the **Control Bar** appears, click the **Menu** icon on the far left to open the **Main Menu** (**Picture 3-2**).

**STEP 4.** The **Login** screen will appear. Enter the User Name and Password, **admin** and **123456** respectively using the Virtual Keyboard described in the last chapter. Click **ENTER** on the keyboard. You can change the password later as described in **Section 4.6 User Management**.



PICTURE 3-1

You are now logged in.



**IMPORTANT!** If you are logging into the DVR for the first time, it is essential that you set your DVR to the proper date and time at this point. Doing so will allow you to search for events based on when they occurred as well as avoiding complications by having multiple recorded files with the same date and time if you wait to make those settings. Complete instructions can be found in **Section 4.1 Basic Configuration**.

#### POWER OFF

The DVR will power down to a standby mode when the **POWER** button on the remote control is pressed, or when the **SYSTEM SHUT DOWN** icon is selected from within the **MENU**. In both cases, the **SHUT DOWN** window will appear and users must select **OK** to confirm. The hard drive will stop spinning and the system will shut down. For extended periods of inactivity, it is recommended that the DVR be disconnected from power either by turning off the power at the surge protector or unplugging the device.

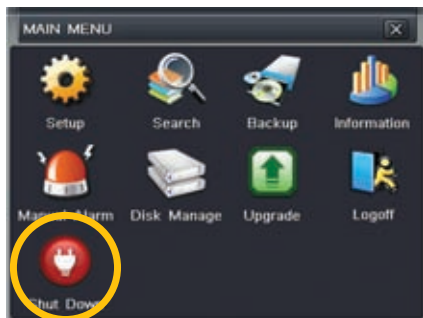

PICTURE 3-2

### 3.2 THE CONTROL BAR

When a user is logged in, pressing the **ESC** button on the DVR or right-clicking on the screen with the mouse will display the **CONTROL BAR** on the bottom of the screen.

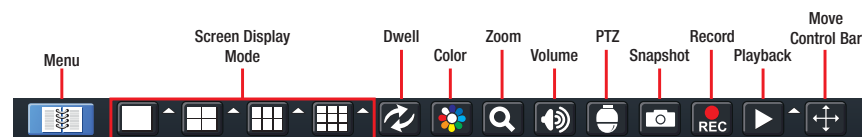

PICTURE 3-3

The functions of the Control Bar are listed below. Screen Display Modes are covered on the next page and the other functions will be covered in more detail in the following chapters.

**Menu:** Opens the **Main Menu**.

**Screen Display Mode:** Choose the number of channels you wish to view at once. Channels without attached cameras will display "Video Loss." Clicking on the upward pointing arrows to the right of each icon will allow you to select which channels to view in that mode.

**Dwell:** Enable/disable automatic cycling between channels.

**Color:** Adjust the brightness, hue, saturation and contrast for any channel.

**Zoom:** Available in single screen display mode, this digitally enlarges a section of the display.

**Volume:** Adjust volume. This is only available if you have attached a microphone or audio-capable camera to the DVR.

**PTZ:** Opens the controls for optional Pan-Tilt-Zoom cameras.

**Snapshot:** Captures a still image from all channels and saves it to the hard drive.

**Record:** Begin manual recording on all channels.

**Playback:** Switches to Playback mode and brings up the **Playback Control Bar**.

**Move Control Bar:** Clicking this will allow you to reposition the Control Bar anywhere on the screen. Right clicking on the screen will hide the **Control Bar**.

## DISPLAY MODE

By clicking on the display mode buttons on in the **Control Bar** you can quickly configure how your cameras' video feeds are displayed. The settings here will temporarily override the default configuration made in the **Main Monitor** tab in the **Live** menu (see **Section 4.2 Live Configuration**). You can select whether to view a single channel at a time, two channels in a picture in picture format, or view multiple channels in a split screen mode. In addition, users have the option to select how many channels to view at once as well as which channels will be shown in that multi-channel display. The number of display mode options and their configuration will depend up on the model of your DVR. With the exception of the nine-channel viewing mode on an eight-channel system, your DVR will not have the option to display more channels than it supports. If you have fewer than the maximum number of cameras connected to your DVR, the channels without cameras will remain black and display a "Video Loss" message.



PICTURE 3-4

Click the  icon beside the desired screen display mode to open the **CHANNEL SELECT** menu.

Users can check any or all channels to display the live feeds (depending on the display mode chosen and the number of channels on the DVR). Click the  box to confirm the settings before closing the **CHANNEL SELECT** menu by clicking on the  button.

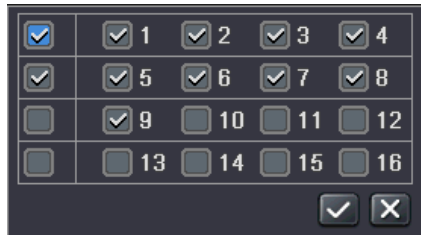

PICTURE 3-5

You can move camera views to a new position by clicking and dragging the desired channel's display. When a channel's view is dragged into another area, the view that it replaces will move to the vacated location.

Double-clicking on any of the channels being displayed will bring that camera's video to full screen. Right clicking anywhere within the image will return the display to its previous mode.

## Asymmetric Display

With the exception of the four-channel DVRs in this series and the QT536, users have the option of viewing cameras using an asymmetric display mode. This modes consists of one large image plus several smaller images. As described above, a camera's display can be dragged from one of the smaller windows into the larger window for easier viewing while maintaining a multi-channel display.

## Picture in Picture

If you wish to only monitor two channels at a time, most QT DVRs (excluding the QT536) feature the Picture-in-Picture mode. The icon for this display mode is shown at the far right of **Picture 3-4**.



PICTURE 3-6



PICTURE 3-7

Clicking on the Picture-in-Picture button will open a pop-up window (**Picture 3-6**) allowing you to select which channel will be the main video feed. Clicking on the button in the lower left of that window will open a second pop-up window (**Picture 3-7**) allowing you to select the channel that will be displayed within the larger image. Note that the channel currently being used for the larger display will be darkened and not selectable.

### 3.3 LIVE VIEWING AND RECORDING

#### SWITCHING VIDEO OUTPUT

The DVR is normally configured to output video signal to a 19" or larger monitor through the VGA port on the back. However, if you have attached a television to the Video Out port instead, then you will need to press and hold the **ESCAPE**, **EXIT** or **STOP** button (depending on model) on the front of the DVR for 10 seconds or until you hear a beep to indicate that the video mode has been changed. On the QT474, the video mode can be changed by pushing and holding the **VGA/TV** button.

#### LIVE VIEWING

The normal mode of the DVR is to display the live feed from the cameras. Configuring which channels will be displayed, naming the cameras and other display settings will be covered in **SECTION 4.2**.



PICTURE 3-8

In addition to the camera images, the DVR will display symbols regarding the status of each camera

Symbol	Meaning	Symbol	Meaning	Symbol	Meaning
	Scheduled Recording		Alarm Recording		Manual Recording
	Motion Detection		Audio Enabled		

#### RECORDING

Your DVR is configured to record whenever motion is detected. It is also set to record at the best setting possible. These settings work for most users, but each user's situation will be different and directions for adjusting these settings can be found in **Section 4.3 Record Configuration**.

### 3.4 QUICK PLAYBACK

Pushing the playback button on the DVR or remote will enable you to play back what has been recently recorded by launching Quick Playback.

Clicking on the **Playback** button within the **Control Bar** will begin the Quick Playback process as well.

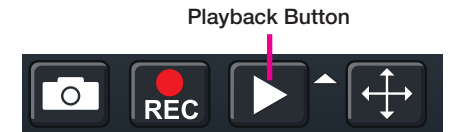

PICTURE 3-9

The time period for the Quick Playback can be set by clicking the upward-pointing arrow icon next to the **Playback** button. You can choose to go back 2-, 5- or 10 minutes. This setting will apply whether you've selected playback on the remote, the front of the DVR or by clicking on the **Playback** button.

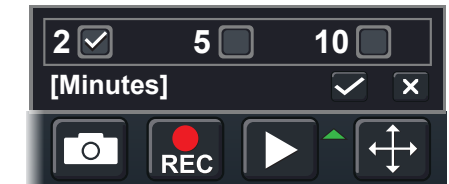

PICTURE 3-10

Only channels with recorded video will display their feeds and those without will be dark. As shown on the next page, a toolbar will appear below the display showing the playback controls. If you are using the mouse, clicking on the various controls will affect the video playback in a similar manner to using the front panel buttons or remote control.

There may be additional video recorded before your starting point and you can go back to the beginning of the recording within this playback. You will, however, need to use the search feature described in **Section 4.8** to locate video event recordings from other days, or earlier times.

## PLAYBACK CONTROL BAR

The controls operate in a similar fashion to those of a conventional DVR or other video playback device but with a few additional commands available to you:

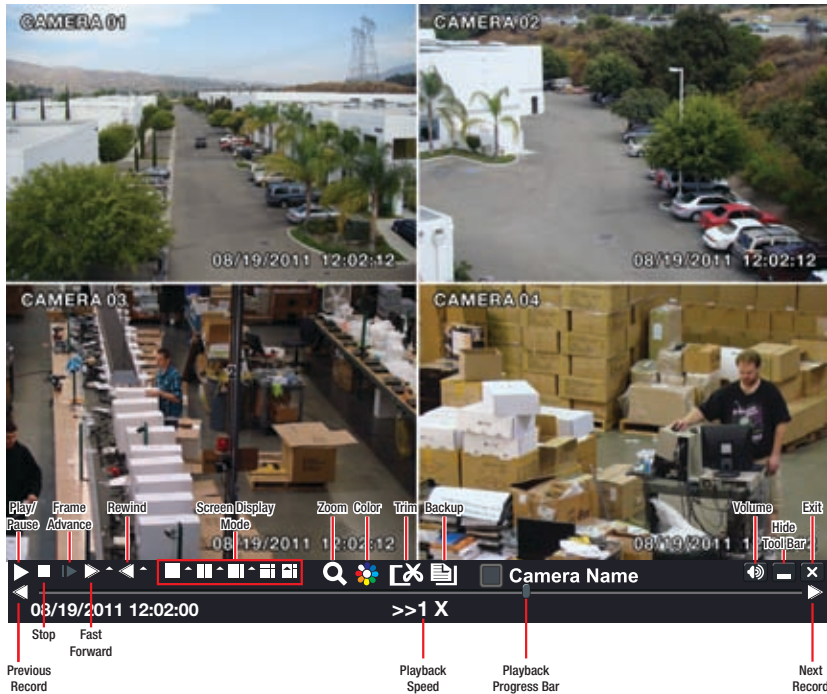

PICTURE 3-11

**Previous/Next Record:** Moves to the prior or following recorded event, respectively.

**Fast Forward/Rewind:** In addition to their normal operation, clicking on these buttons multiple times will speed up or slow down the rate or progression - forwards or backwards - through the file. The speed can also be selected directly by clicking on the small upward pointing arrows to the right of each button. You can select from 1/4 speed to 16-times normal speed forward and rewind speeds of 8-times, 16-times and 32-times normal speed. The current speed will be displayed at the bottom center of the Playback bar.

**Screen Display Mode:** As with the **Control Bar**, these icons allow you to choose the number of channels you wish to view in playback. Clicking on the upward pointing arrows to the right of each icon will allow you to select which channels to view in that mode. Channels with no recordings will appear blank.

**Zoom:** Available in single screen display mode, this digitally enlarges a section of the display. Select this tool and then click-and-drag to select a portion of the video feed to enlarge it. Clicking and dragging within the zoomed-in area will allow you to move to other areas of the image. Right-clicking will return the video to regular display mode.

**Color:** Adjust the brightness, hue, saturation and contrast for any channel. Please note that this will only effect the playback for this channel on the DVR itself. It will not change the recording.

**Playback Progress Bar:** The slider moves along the Playback Progress Bar as the video plays. Moving this with the mouse will go to another segment of the video. You can move to another point in a single video by first clicking on that channel and then moving the slider to the desired time. Other channels will continue progressing normally.

**Trim:** Using this tool allows you to save a segment of the video record rather than having to back up the entire file.

To select a segment move the **Playback Progress Bar** to before the desired location in the video and begin playback. Once you reach the desired starting point, click on the **Trim** button to set the beginning of the clip. The button's icon will flip indicating that it is waiting for you to select the ending point. When you have reached that point, click the button again to complete your edit. The starting and ending times will be displayed at the bottom of the **Playback Control Bar**.

**Backup:** Once you have created your video clip, the **Backup** button will turn white indicating that you can save your clip directly to a USB drive connected to the USB port on the front of the DVR. The drive must be connected before clicking on the **Backup** button.

When the **Backup** button is clicked, the **Backup window** will open. It will list details about the file and the storage media that you have connected. If you have more than one drive connected - including ESATA, USB CD/DVD burners or other external media, you can chose the desired destination in the **Storage Media** pull-down.

If you do not have enough space on the disk to save your file, you may select **Disk Cleanup** to remove all files from that disk.

Chose the format in which you want to save your video clip. The .DVR format requires a special player program which will be included in a second folder on the drive. The .AVI format will work with most standard media playback software on PC or Mac computers. If selecting .AVI as the format for your files then you should deselect the **Backup Player** box. Click **Start** to begin the download and the progress bar at the bottom will fill up as the file is transferred.

For more information regarding backing up files, please see **Chapter 5**.



PICTURE 3-12



PICTURE 3-13

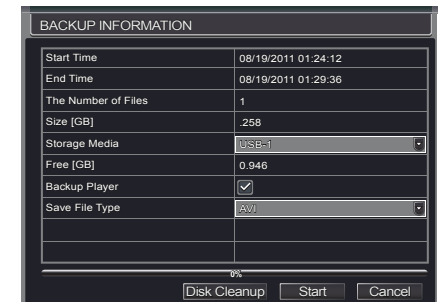

PICTURE 3-14

### 4.1 BASIC CONFIGURATION

This chapter is intended to help you get your DVR up and running before you activate any advanced features which are covered in later chapters. You can use the mouse, remote control and the buttons on the front of the DVR to operate your system, but for convenience, we will be discussing operations using the mouse. Information on P.T.Z. cameras and alarms will be found in their own chapters, **Chapters 7** and **8**, respectively.

### MENU NAVIGATION

Navigation through the user interface is point and click. Double-clicking on an icon within a given menu will open that menu, or a submenu. The Main Menu is the starting point to reach all of the DVR's settings and features. Selecting the **Menu** icon on the left of the **Control Bar** or pressing the **Menu** button on the DVR and remote control open the **Main Menu**.

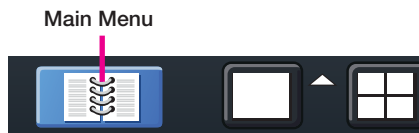

PICTURE 4-1

Clicking on any icon will open the relevant menu.

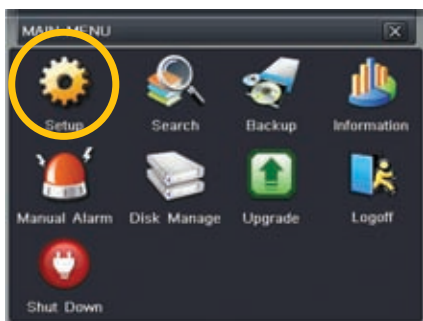

PICTURE 4-2

### SETUP

From the **Setup** menu select the **Basic** menu by clicking on its icon.

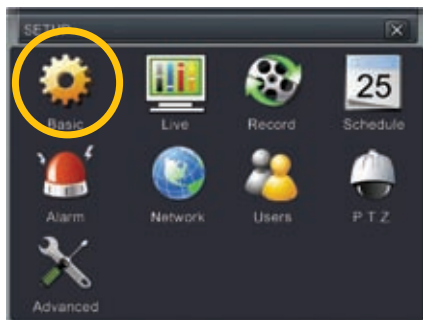

PICTURE 4-3



**NOTE!** When configuring your settings, you will always need to click **Apply** to save your current settings before closing the window with **Exit** otherwise your changes will be lost. You may click **Exit** or the close window box (X) in the upper right of the window to close without saving changes but an alert will pop up asking if you wish to save changes. Click **OK** to save changes or **Cancel** to continue without saving. You may select the **Default** button to restore your settings to those set at the factory.

### BASIC MENU

There are three tabs covering **System**, **Date & Time** and **Daylight Savings Time (DST)**. In the first tab, System you will set the date, time along with other desired settings.

#### System Tab

The following settings can be changed in this menu:

**Device Name:** This will display when you access the DVR remotely via your mobile device, a web browser or through the CMS software. Naming the device will help users recognize the device when monitoring numerous DVRs remotely.

**Device ID:** If you have multiple systems, you can give this device a numerical ID.

**Video Format:** Select between NTSC (North America) or PAL (Europe) video standards.

**Password Check:** By enabling this, a user will need to enter name and password when performing configuration operations.

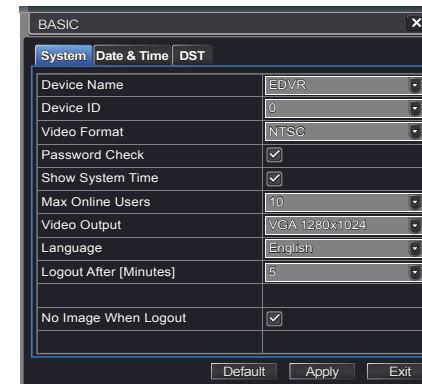

PICTURE 4-4

**Show Time:** Displays the time on-screen in Live View.

**Max Network Users:** Set the maximum number of network connections - up to 10.

**VGA Output:** Chose the configuration that best fits your monitor. Options are: VGA800\*600, VGA1024\*768 (Default), VGA1280x1024 and CVBS. NOTE: VGA is for VGA monitors while CVBS is for TV monitors connected using a BNC/RCA adaptor. Switching between VGA and CVBS will change the menu output mode. Please be sure to have the correct monitor on hand when changing output mode.

**Language:** Select your preferred menu language. The DVR will have to restart for this change to take effect.

**Logout After... :** You can have the DVR automatically log a user out after a period of inactivity. The period can range from 30 seconds (.5), 1, 3 or 5 minutes or never.

**No Image When Logout:** The monitor will not display the Live View when this box is unchecked.



**IMPORTANT!** After changing the Language or Video Format, the device will need to be restarted.



## Date & Time Tab

Set date, time, time format and related configurations in this menu.



**IMPORTANT!** To maintain the integrity of recorded video, you should set the DVR to the correct date and time before making changes in other menus.

Setting the correct date and time before proceeding is essential to maintaining the integrity of your video records - especially for purposes of evidence. Making these straightforward settings should be your first priority before proceeding further within this manual. Changing the date and time after important videos have been recorded could result in the loss of those files.

Most of the options within this menu are self-explanatory. If you are unsure of your time zone, the date and time settings on your computer or searching online for "Time Zones" will quickly provide you with the information you need.

**NTP Server:** Using Network Time Protocol will keep your system's clock current by allowing it to occasionally receive updates from the selected server. Your DVR must be connected to the Internet for this feature to work. Please see the Remote Monitoring Guide for instructions.

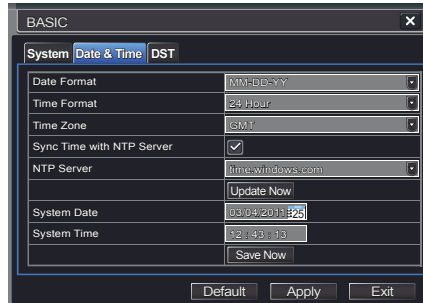

PICTURE 4-5

## DST Tab

This setting allows your system to adjust for time changes due to Daylight Savings Time. Again, your system must be connected to the Internet for this feature to work. As of this writing, Daylight Savings Time begins in most areas of North America on the 2nd Sunday in March and ends on the first Sunday in November. Both changeovers happen at 2 am. Allowing the DVR to make the change automatically ensures that files will not be lost as could happen by manually changing the hour.

Checking the box marked **Daylight Saving Time** will enable the DVR to switch the hour automatically.

The starting and ending periods must be set using the pull down options along with entering the hour manually. The **Week** radio button should be selected for this method.

If your region switches to and from DST on a specific date, then chose the **Date** radio button and enter the needed information.

Click **Apply** to save your settings and **Exit** to close the menu.

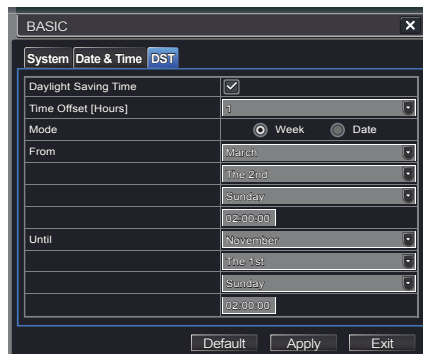

PICTURE 4-6

## 4.2 LIVE CONFIGURATION

Live configuration includes four submenus: **Live**, **Main Monitor**, **Spot** and **Mask**.

### Live Tab

Use this menu to set camera names and adjust picture colors, brightness, hue saturation and contrast for optimal picture results.

You can individually name cameras by highlighting the field for each camera. The virtual keyboard will appear allowing you to enter characters, numbers and symbols with case sensitivity. **ENTER** will save the name and return to the **LIVE** menu. **ESCAPE** will exit the keyboard without saving.

You can enable or disable the display of the cameras' names and recording status (see **Section 3.3**) by using the check boxes.

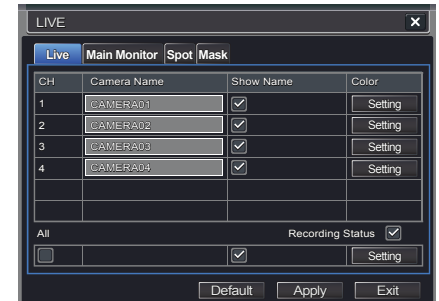

PICTURE 4-7

You can configure the color settings for each channel individually. Adjust image saturation, hue, brightness, and contrast by clicking on the Setting button for each individual camera or for all of them simultaneously by selecting the All button before making the settings. This window can also be reached by clicking the color button on the **Control Bar**.



PICTURE 4-8

### Main Monitor Tab

Select the configuration of your display.

Split Mode allows you to choose from single view, 2x2, 2x3, 3x3, 4x4 (depending on model) views on a screen at one time. You can also select which channels will be displayed.

Channels can be grouped and the display will cycle between groups. Any individual channel can be shown in more than one group.

**Dwell Time:** This is the time interval the display will spend showing a group before moving on to the next group.



PICTURE 4-9



**NOTE!** If viewing remotely on a computer with dual monitors, the display must be on the main monitor.

### Spot Tab

This allows select feeds to be viewed on a separate monitor that is connected to the DVR but may be in another room, for example. There will be no menu access on this auxiliary display.

Only one channel can be displayed at a time on this monitor. You can choose which channels (each channel is a "group"), the order and their dwell time. The left and right arrows allow you to move to the next group. A channel can appear in more than one group.



PICTURE 4-10

### Mask Tab

Set up masks on individual cameras to block out select areas on each screen. This is to grant privacy in situations when other users may be able to view the camera feeds and you wish to restrict viewing of certain areas or activities.

Click on the **Setting** button next to a given camera to apply a mask to its view.



PICTURE 4-11

Up to three areas may be masked in an image. Simply click and drag to cover the area. To delete, double-click on a mask.

Right-click to exit the screen, your masks will be saved.

The masks will appear on that channel's image in the live area as well as on recordings.



PICTURE 4-12

## 4.3 RECORD CONFIGURATION

QT4 Series DVRs are set to record in real-time (30 frames per second) in the CIF format. Depending on the model, one or more channels may be set to record in the higher resolution in real-time, or all channels may record in D1, but at a reduced frame rate. QT5 Series DVRs, along with the QT454, are configured to record in real-time on all channels in the high-resolution D1 format. The QT2124 can only record in the CIF format. There are five sets of options; **Enable**, **Record Bitrate**, **Time**, **Stamp** and **Recycle Record**.

### Enable Tab

Select some or all of the cameras to record to the DVR. Depending on your DVR model, you can set up to 16 cameras to record audio in addition to video. This will require cameras equipped with microphones or separate microphones co-located with the camera(s). You can globally select all the cameras regardless of their individual settings by selecting the **All** box below each column.



PICTURE 4-13

### Record Bitrate Tab

Set up the resolution, quality, encoding, quality and maximum bitrate of the video stream according to your needs. You can set each camera individually, or globally by using the **All** function at the bottom of the window.

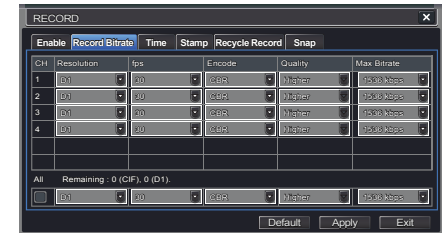

PICTURE 4-14



**NOTE!** While each camera can have its resolution and frame rate set independently of the other cameras, the DVR may limit the frame rate available to a camera based on the settings of other cameras.

Parameter	Options	What it Means
Resolution	D1, CIF	D1 = Full TV resolution, CIF = 1/2 D1. D1 takes more room on the hard drive than CIF
FPS	1-30	Frames per second. More frames makes for smoother video but takes up more room on the hard drive.
Encode	VBR, CBR	Variable Bit Rate versus Constant Bit Rate. VBR provides better image quality for video with motion in it, but at the expense of a larger file size.
Quality	Lowest - Highest	Only available when VBR is selected. The higher the quality, the more drive space required. CBR's default setting is for higher quality.
Max Bitrate	256-2084kbps	This sets the maximum bitrate that each camera will record at with VBR encoding selected.

### Time Tab

You can set the length of time the DVRs record an event before and after a motion detection or alarm is triggered as well as how long an individual record is preserved.

**Pre-alarm record time:** This sets the length of time showing events prior to a motion detection or sensor-triggered event that is included in the record.

**Post-alarm record:** Sets the length of time - from 10 to 60 seconds - that is added to the record after the event is finished.

**Expire time:** The time - up to 60 days - that an event is saved on the drive before it could be overwritten (See **Recycle Record** below).



PICTURE 4-15

You can set up all channels with same values by selecting **All** and then configuring one channel.

### Stamp Tab

Select which cameras will display their ID and date stamp and where it'll appear on the screen.

Drag and drop the location of the camera name and date/time stamp to your desired location on the screen. This can be done individually or globally. A "Before" and "After" example is shown below.



PICTURE 4-16

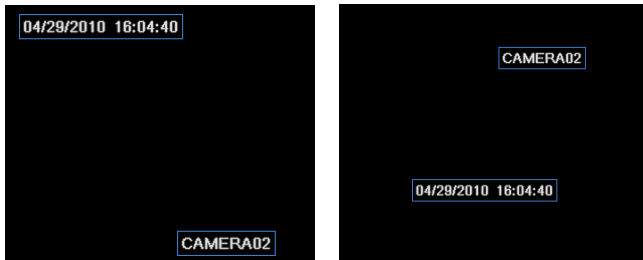

PICTURE 4-17

### Snap Tab

In this tab, you can configure how many still images are taken, the quality of the images and the timing between them when the **Snapshot** button is pushed on the **Control Bar**.

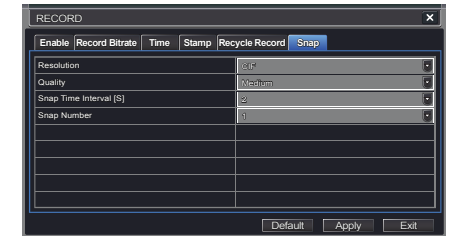

PICTURE 4-18

### Recycle Record Tab

This is selected by default. Recycle record allows the DVR to record over old events when the hard drive is full. Otherwise, the DVR will stop recording when there is no more space available.

## 4.4 SCHEDULE CONFIGURATION

Your DVR is configured to record whenever motion is detected. If this is your desired setting then you will not need to make any changes. However, you may configure each channel to record at specific times based on time of day, motion detection or other sensor input. There are three tabs; **Schedule**, **Motion** and **Sensor**

### Schedule Tab

The schedule for automatic recording can be set either of two ways.

1. By highlighting individual hours for specific days by using the pencil tool in the upper right of the window. The adjacent eraser tool removes the highlighting in a block. Double click on either the pencil or eraser tool to turn them off. Settings can be copied and applied to any or all of the channels and to any other day.

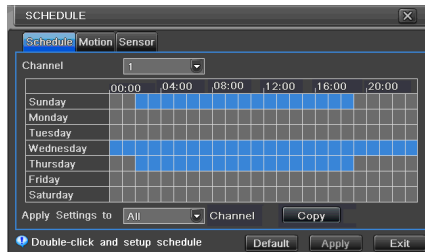

PICTURE 4-19

2. Blocks of time to be recorded can also be set up by double clicking on a field adjacent to a day. Multiple schedules can be created and saved with start and stop times down to the minute. These can then be applied to multiple days and cameras.



PICTURE 4-20

Schedules made in one mode can be altered in another mode.

### Motion Tab

Motion detected during the highlighted hours will cause the DVR to start recording. Setup is similar to that used in **Schedule** above. The default mode is for 24/7.



PICTURE 4-21

### Sensor Tab

This enables the DVR to record based on input from other sensors connected to the DVR. Like motion detection, it is default scheduled to be able to record at any time. It is also configured in the same manner as explained under **Schedule**.



PICTURE 4-22

## 4.5 NETWORK CONFIGURATION

The **Network Configuration** window is used to control how your DVR works in a networked environment. This section offers a brief overview of how to set up your DVR so that it can be remotely monitored from another computer on your network, over the Internet or from mobile wireless devices. Full, in-depth instructions on the functions and settings available in this window are presented in the **Remote Monitoring Guide** which is on the disk that came with your system or which can be downloaded from our website at [www.Q-See.com/Support](http://www.Q-See.com/Support). The four tabs in this window are **Network**, **Sub-Stream**, **Email** and **Other Settings**. If you will only be monitoring the DVR from another computer on your network, you will only need to use the first three tabs.

It is important that your DVR is connected to your network router and that the router is powered on before proceeding.

This window displays the information on the DVR's local network and Internet addresses which will allow you to access the DVR on a network. As discussed in the Remote Monitoring Guide, you will use the local network address to access your system from the same wireless or intranet network that the DVR is connected to. When you are outside of that area, you will use the Internet address shown (see below) or the DDNS address that you will set up.



**IMPORTANT!** The majority of routers available on the market since 2008 have Universal Plug and Play (UPnP) capability, which allows the DVR to connect automatically to the network. Consult the **Quick Networking Poster** or the **Remote Monitoring Guide** before changing Network settings.

### Network Tab

**HTTP Port** – This is the port the DVR will use to communicate through the router. When accessing the DVR remotely from the Internet, you will need to enter your network's remote IP address (obtained in the next step) in the address bar of an Internet Explorer window. For example: <http://88.116.0.25>

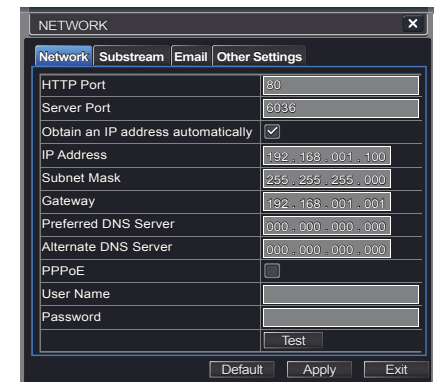

PICTURE 4-23



**NOTE!** The default value is 80. If port 80 is already occupied by another device on the network, then another port will need to be selected. Choose another number in the same range; 81-89. In this case, you will have to add the port to the IP address when entering it into the Internet Explorer window. For example, if the port is now 82, then you will need to enter <http://88.116.0.25:82>

**Obtain IP Address Automatically** – Clicking this box will obtain the IP address, subnet mask, and gateway IP from the router.

**PPPOE** – Selecting this enables Point-to-Point Protocol over Ethernet (PPPoE) which allows you to directly connect your DVR to the Internet through your modem. Do not use this unless you are connected to a modem instead of a router. Contact your ISP for your account information including user name and password. The **TEST** button will verify that your information is correct.

## Definitions and descriptions of network configuration:

Parameter	Definition
HTTP Port	The network port number for accessing the DVR from a remote location. The default port is 80
Server Port	The port number for data. The default port is 6036
<b>Static IP</b>	
IP Address	The IP address of the DVR on your network
Subnet Mask	The server's subnet mask
Gateway	The gateway of the router
DNS Server	The address of the Domain Name System (DNS) server
<b>PPPoE</b>	
User Name	User name of the broadband account
Password	Password for broadband account

## Substream Tab

The substream is the data that is sent to remote monitoring devices. Due to bandwidth concerns, these data streams are generally smaller than those sent directly to the DVR itself. These streams run in parallel with the main stream sent to the hard drive and they do not affect each other.

Substream settings are configured in the same manner as that used for the primary stream settings in the **Record Bitrate** tab in **Section 4.3**. Certain settings will be grayed out and cannot be changed due to throughput concerns. The definitions are repeated for your convenience:



PICTURE 4-24

Parameter	Options	What it Means
Resolution	D1, CIF	D1 = Full TV resolution, CIF = 1/2 D1. D1 takes more room on the hard drive than CIF
FPS	1-30	Frames per second. More frames makes for smoother video but takes up more room on the hard drive.
Encode	VBR, CBR	Variable Bit Rate versus Constant Bit Rate. VBR provides better image quality for video with motion in it, but at the expense of a larger file size.
Quality	Lowest - Highest	Only available when VBR is selected. The higher the quality, the more drive space required. CBR's default setting is for higher quality.
Max Bitrate	256-2084kbps	This sets the maximum bitrate that each camera will record at with VBR encoding selected.

## Email Tab

This tab allows you to set how your DVR will send out e-mail alerts. You will be able to send e-mail alerts to three addresses.



**NOTE!** Depending upon your settings, the system can generate a lot of e-mail alerts. For that reason, we recommend setting up a dedicated e-mail address specifically for the system to send alert notices. If you do not have your own e-mail system (such as a corporate mail server) you should consider using a free e-mail provider. However, because many free e-mail services allow only a limited amount of e-mail traffic we specifically recommend using Google's Gmail service with its higher limit. Similarly, you will want the alert e-mails to go to a different account than the one sending them. This will ease your management of these alerts and help keep your mail account from overflowing.

If you do not have your own e-mail system, please set up a free account which the DVR can use to send out alerts before proceeding.

For the example below, we will use Gmail. The settings can be found under **Options** when logged into your Gmail account.

Clicking on any of the fields will bring up the virtual keyboard allowing you to enter the data. The virtual keyboard is capable of handling upper and lower case letters as well as numbers and symbols. Click the **ENTER** button to enter your input or **ESC** to exit the field without applying any changes.

**SMTP Server:** smtp.gmail.com

**Port:** 465 (standard port for Gmail - others may vary)

**SSL Check:** You will need to select this for Gmail. Other ISPs may vary.

**Send Address:** Enter your new address. This will appear on alert e-mails sent from the DVR

**Password:** Enter the password you created for this account. Remember, it will be case-sensitive.

**Receive Addresses:** You may set up to three e-mail addresses to receive alerts. It is strongly advised that you do not use the same address that the DVR is using to send alerts.

### Advanced

**Attaching Image Amount:** The alert e-mails can include up to three images

**Snap Time Interval:** The interval of the images can range from every second to every five seconds.

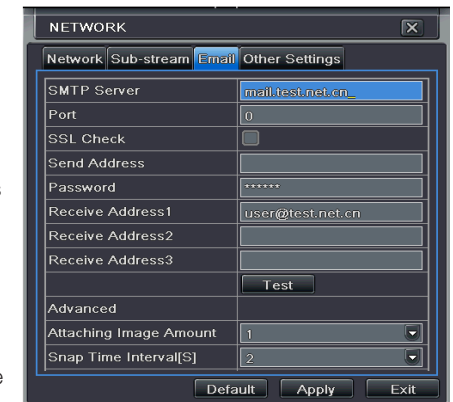

PICTURE 4-25

## Other Settings

Commercial ISPs provide their customers with dynamic addresses (IP numbers). These numbers can change from time to time depending upon your service provider. When they do, you will lose the ability to remotely access your DVR from your mobile phone or other out-of-network device. To prevent this from happening, we recommend using a Dynamic Domain Name Service (DDNS). This will give you a domain name that can be linked to your IP address and will automatically – and invisibly – forward remote connections to your network when the IP address changes.

Q-See offers DDNS for free at [MyQ-See.com](http://MyQ-See.com). Create a domain name, user name and password before proceeding. [DynDNS.com](http://DynDNS.com) also offers a similar free service. This is covered in-depth in the **Remote Monitoring Guide**.

Select the box in the DDNS field to enable DDNS. You will then enter the user name, domain name and password you created into the appropriate fields. You can also select the interval in days at which the DDNS checks to see whether your IP address has changed. Intervals range from every 30 minutes to once a day.

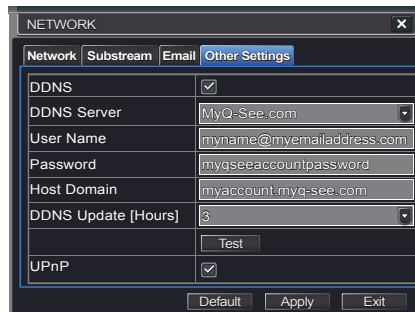

PICTURE 4-26

You can now access the DVR remotely by inputting that domain name into the web browser.

## 4.6 USER MANAGEMENT

You can set up accounts for each individual user and grant them control of select parts of the surveillance system. An administrator account is already created on the DVR. Additional accounts can be created for users but only one administrator account is allowed.



PICTURE 4-27

To add a user select the **Add** button and the **ADD USER** window will open. It will have two tabs; **General** and **Authority**

### General Tab

Input the name, password and select the type of user – normal or advance.

If you only want this user to be able to access the DVR from a specific computer on the network then select the **Binding PC MAC Address** option and then enter the MAC address of that computer.



PICTURE 4-28

### Authority Tab

In this tab you can give this user access to all or part of the system and its functions.



PICTURE 4-29

**Setup** button – Modify user's name, type, binding PC Mac address and etc. The Admin account may not be modified.

**Delete** button –Remove a user from the system

**Change Password** button – Modify a user's password. The admin password may be changed. The default is **123456**.

To change a password, simply click on the button and enter the current password in the pop-up window, along with the desired new password in the **New Password** and **Confirm Password** fields before clicking **OK** to save and **Exit** to close the window.

## 4.7 ADVANCED

In this set of commands, the user can erase all the settings, import or export data files to and from the DVR and control who can remotely access the DVR through three submenus: **Reset**, **Import/Export** and **Black/White List**.

### RESET

Clicking on this option will open a warning dialogue asking you to confirm that you wish to remove all settings and reboot the system. You must select **OK** to continue with the reset or hit **CANCEL** to exit without changes.

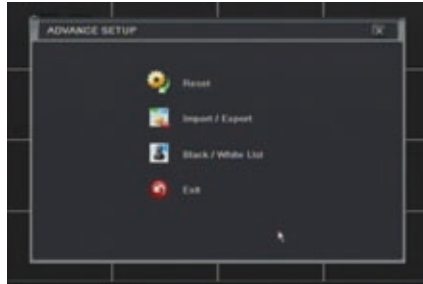

PICTURE 4-30

### IMPORT/EXPORT

Use this interface to export select data files to mobile Flash drives or an external USB drive through the backup function. Specific data files can also be retrieved from mobile or external storage devices and recorded onto the DVR.

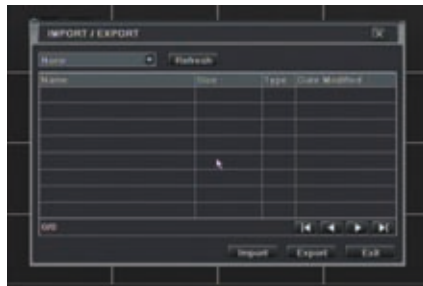

PICTURE 4-31

### BLOCK/ALLOW LIST

From here, an authorized user can control which computer users are allowed to access the DVR.



PICTURE 4-32

The **Block List** is used to deny access to remote computers within a certain IP address segment.

The **Allow List** is used to permit access by users from select IP address segments.

**EXAMPLE:** You wish to block access to the DVR from computer users within the IP address segment ranging from 196.168.000.002 to 196.168.000.004. Select the **Block** button and then enter the first segment in the **IP From** field and the last address within the segment in the **To** field. You may add additional segments before hitting **Apply** to save your settings and then exiting this window.

## 4.8 FILE SEARCH, PLAYBACK AND MANAGEMENT

Access the recordings on the DVR, play them back and backup the recordings to an external storage device.

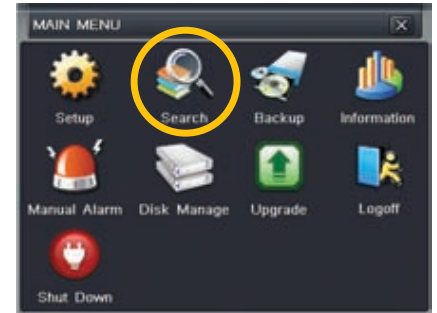

PICTURE 4-33

Four submenus appear in this section: **Time Search**, **Event Search**, **File Management** and **Image**.



**NOTE!** Throughout this window, if the screen resolution is VGA 800\*600, the time search interface will show a **Hide** button. Clicking on this button will expand or minimize the entire interface as needed.

### TIME SEARCH

Search for an event within a range of dates and times.

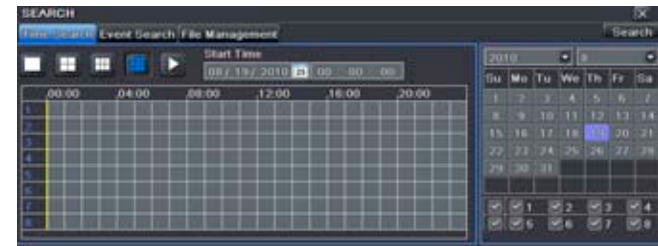

PICTURE 4-34

Select which channel you wish to search and the screen display mode. The **Calendar** icon in the **Start Time** window allows you to select a start date. Highlighted dates indicate that there is recorded data for those days.

The vertical column of numbers to the left of the grid are the available channels. The horizontal headings are blocks of time within the day.

You can select which time to begin the review by entering it in the start time window or clicking on the time grid and moving the yellow line to the approximate start time.

Clicking on the **PLAY** button will begin the playback from the time selected. It will also bring up a playback toolbar allowing finer control of the playback process.

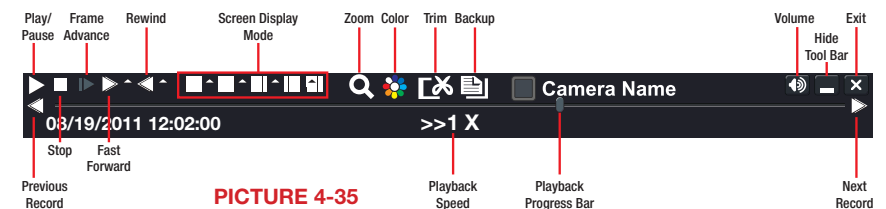

PICTURE 4-35

## EVENT SEARCH

Selecting this tab will bring up a list of recorded events. Your DVR is configured by default to record when motion is detected. You can choose whether to display events triggered by Motion, Sensor or both. These files are saved as events.

Select the date you wish to search and click the **Search** button. You will be presented with a list of recorded events.

Select the channel and click the Double-click the event file you wish to play back.

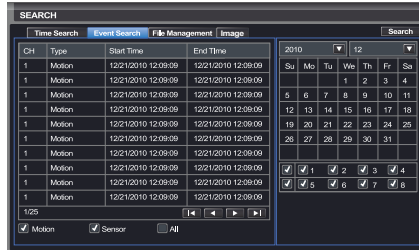

PICTURE 4-36

## FILE MANAGEMENT

From within this tab you can lock, unlock or delete recorded events from the drive.

Clicking the **Search** button in the upper right of the window will bring up a list of events to be displayed. Results can be filtered by selecting date and channels if desired.

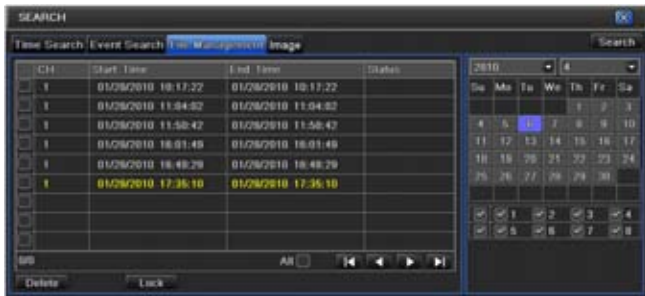

PICTURE 4-37

**LOCK** – Selecting a file and then clicking the Lock button will protect the event from being overwritten or deleted unless the entire drive is reformatted

**UNLOCK** – This will remove the file protection and the event recording can be deleted or overwritten normally

**DELETE** – If the event is not Locked, this will remove the selected event from the DVR.



**NOTE!** If the status shows “Writing” it means that the sector on the hard drive where the file is located is still being written to. You cannot delete the file until the file is completed and the word “Writing” disappears.

## IMAGE

This tab functions much as the **Event Search** tab by allowing you to search for and view the still images captured when you click on the **Snapshot** icon on the **Control Bar**. These images are stored on the DVR’s hard drive just as with video files.

Select the date to search, along with the start and end times to search between. You can also select which channels you want to include in the search. Clicking the **Search** button in the upper right of the window will bring up a list of available images.

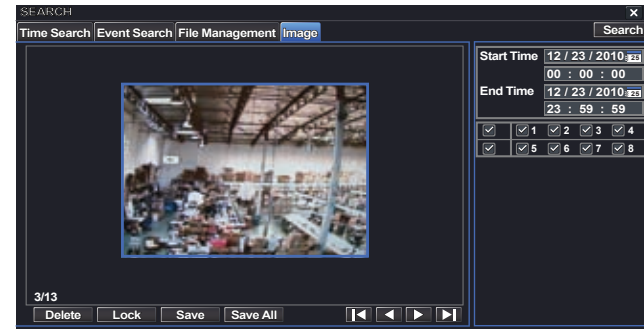

PICTURE 4-38

After the search is completed, a count of available images will be displayed along with the first still image. The buttons at the bottom of this tab allow you to navigate through the images as well as save them for use outside the DVR.

**DELETE** – This will remove an unwanted image from the hard drive.

**LOCK** – This will prevent a file from being deleted. If a file is locked, this button will read **UNLOCK**.

**SAVE/SAVE ALL** – These buttons allow you to save individual or all of the images in the group to an external USB flash drive inserted in the USB port on the front of the DVR.

**ARROW BUTTONS** – Navigate to the first, last previous or next image in the group.



This DVR supports backing up files to USB flash drives, USB hard drives and USB DVD burners through the USB port on the front panel. Remote backups can be performed over the Internet. Refer to Section **2.4 Remote Backup** in the **Remote Monitoring Guide**.



**NOTE!** External USB hard drives used for backing up data will need to be in the FAT32 format. Most new drives will need to be reformatted before use with this DVR.

## FORMATTING A USB DRIVE IN FAT32

To format a USB flash drive with FAT32, plug it into a PC running Windows XP or later. Go to **My Computer** to locate the drive's icon. Right click on it and select **Format** in the list of available options. Select **FAT32** and check the box marked **Quick Format** before clicking **Start**.

For USB drives over 32GB in size, you should use a FAT32 format utility such as those available through **CNET.com**.

## BACKING UP A FILE

Selecting **BACKUP** in the **Main Menu** will open the **Backup** configuration window.

The search for files to backup is much like the method used to search for files to play back as was covered in the previous chapter.

Set the start and end times as well as channel(s) you wish to back up. Clicking the **Search** button will bring up the search results in the **Data Backup** list box.



PICTURE 5-1

Select specific events or select the **All** button. Clicking the **Backup** button will bring up the **Backup Information** window:

This window will present a summary of the number of files, starting and ending times, total size of the files and whether you have space available on the receiving storage media. **Disk Cleanup** will erase the contents of the storage media to make room. You can select which type of device you are recording to as well as what type of file you will be creating.

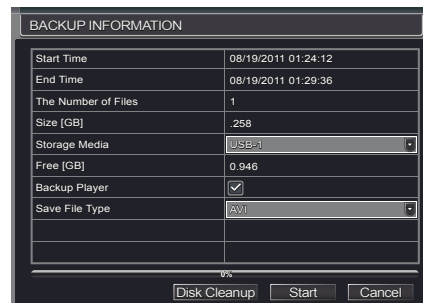

PICTURE 5-2

**Save File Type:** Choose between **DVR** and **AVI**. The former will save the video in a proprietary format while the latter will create a standard .avi file usable by most media playback software. If you choose the **DVR** format, you need to select the Backup Player option (see **Picture 5-2**) as well. This will save a stand-alone playback program in a separate folder labeled **Video Play** on the same drive.

Clicking on the **Start** button will begin the backup and the progress bar will display the progress.

## PLAYING BACK A VIDEO FILE ON A COMPUTER

**Windows PC** - You may play AVI formatted files using Windows Media Player, QuickTime, DivXplayer or other media players. The files can be opened and played in a similar manner to any other media file. You may need to download and install the K-Lite Codec as described above.

The Superplay.msi program is a PC-only application and is saved onto the same drive as video files when the Backup Player option is selected. Launch the software in the normal manner and then click on **Open Path** and navigate to the folder containing the video files and select the file you wish to play back.

**Apple Macintosh** - At this time, you must use the **Remote Backup** feature to save the file to your computer through the remote viewing software. See section 2.4 of the Remote Monitoring Guide for instructions on this process.

You **MUST** select the **AVI** format when backing up the video file for playback on a Mac computer. You can use the QuickTime player or other video player and open the video file in the normal manner.

### 6.1 INFORMATION

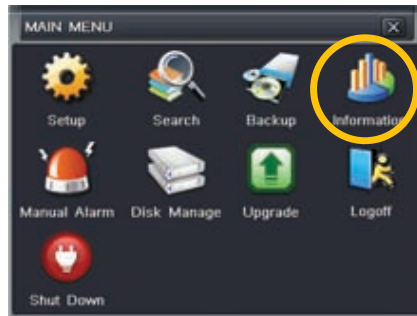

PICTURE 6-1

This window enables the user to monitor the status of the system, its network connection, online users, history and events through five submenus: **System, Event, Log, Network** and **Online Users**.

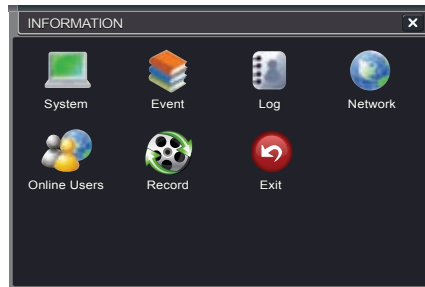

PICTURE 6-2

### SYSTEM INFORMATION

Data on the system's hardware, MCU (MicroController Unit), kernel (if applicable) and firmware versions can be found here along with the device's name and ID.

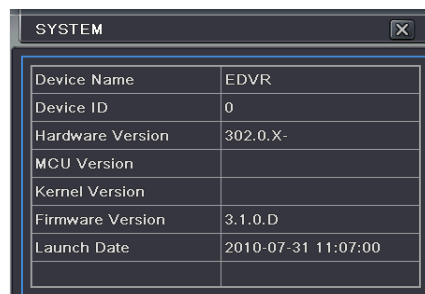

PICTURE 6-3

### EVENT INFORMATION

This window lists recorded events. This list can be searched by date, time, type of event and channel.

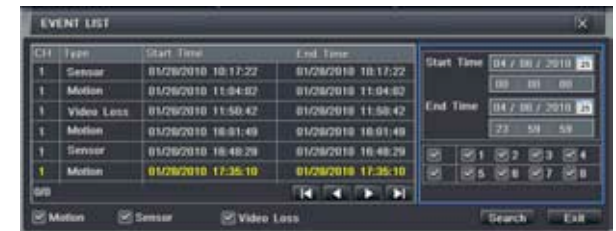

PICTURE 6-4

### LOG INFORMATION

This window lists user activity within the system.

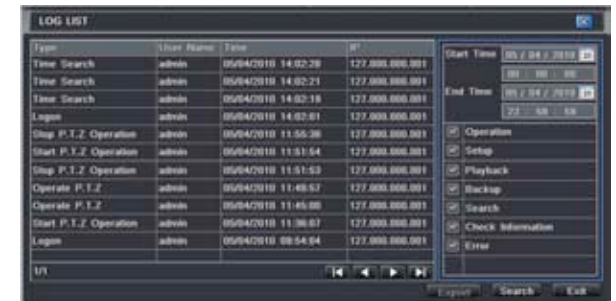

PICTURE 6-5

This record can be searched by type of operation, date and time, and etcetera. It can also be exported to external USB storage devices using the backup function.

### NETWORK INFORMATION

This window shows the status of the DVR on the network including its assigned port, and other networking configurations.

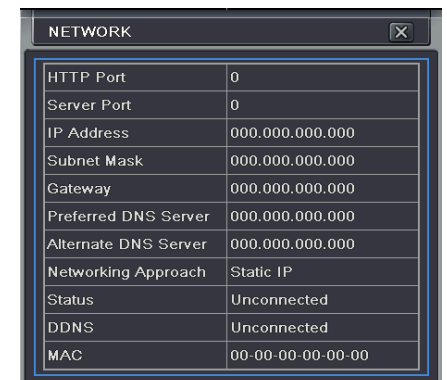

PICTURE 6-6

## ONLINE USER INFORMATION

Information on remote users currently connected is displayed in this window.



PICTURE 6-7

**Refresh** – Updates the list of online users

**Disconnect** – The Administrator can disconnect a selected user from the DVR. That PC will not be able to access the device for five minutes thereafter.

## RECORD INFORMATION

This window provides information on your camera's recording resolution, the recording speed and what mode the camera is operating in. At the bottom is a bar indicating the percentage of the hard drive's capacity that has been used.

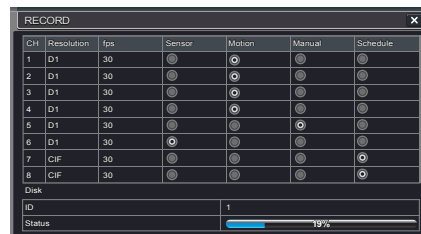

PICTURE 6-8

## 6.2 MANUAL ALARM

This displays the configuration of the manual alarm. See **Chapter 8** for information on connecting and setting up alarms.



PICTURE 6-9

## 6.3 DISK MANAGEMENT

This window displays information on the drive or drives mounted within the DVR including size, available space and status.



PICTURE 6-10

The drive can be set to read only, which will disable recording, but will preserve the data currently stored within it.

If you have upgraded your system by installing a new drive (**See Chapter 9**) you will need to first format the new hard disk before recording. You can reformat the current drive if desired by selecting the Format option in the drop down menu.



**WARNING!** Reformatting the drive will delete all recorded files stored on the hard disk regardless of whether they are Locked!

**Refresh** will update the information about the drive.

## 6.4 UPGRADE

This window will display firmware updates that are loaded on a USB flash drive in the front USB port.

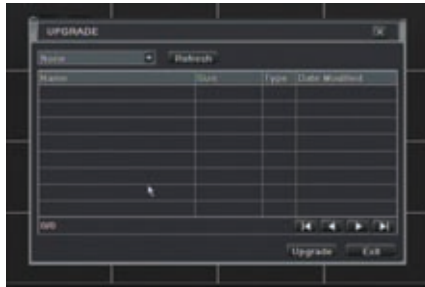

PICTURE 6-11

Firmware upgrades are available from Q-See at [www.Q-See.com/Support](http://www.Q-See.com/Support) and may be found by looking up your specific model. Firmware should only be upgraded to fix a specific problem or add features as ongoing development may result in features being removed.

The firmware download should be loaded onto an empty USB flash drive from the downloading computer and then transferred to the DVR using a USB port.

## 6.5 LOGOFF

Logging out of the DVR is recommended when there are multiple users or when physical access to the DVR is not restricted. Clicking on the **Logoff** icon will bring up a window asking for confirmation.

After logging off, a user can log back in by clicking on the **Menu** icon and entering their user name and password.

## 6.6 SHUT DOWN

This is a “soft power down” of the DVR. It shuts down the firmware and hard drive, but does not power down the DVR itself.



**WARNING!** It is vital that the DVR be instructed to shut down using the **Shut Down** menu option prior to unplugging the device in order to avoid damaging the firmware or hard drive itself.



**IMPORTANT!** Please make note of your settings before updating the firmware on a QT426 or QT446 as the upgrade process will restore factory defaults. Other models will retain their user settings.



**NOTE!** While a Macintosh computer can read and write to a drive in the FAT32 format, it cannot reformat a USB flash drive to that standard. We suggest that you use a PC to reformat your USB flash drive to FAT32 and it is recommended that you download firmware updates on a PC. Beginning with version 3.1.71, you can use the Upgrade feature in the Remote Monitoring software (see **Section 2.5** of the **Remote Monitoring Guide**) to upgrade without a USB flash drive.



**WARNING!** Updating the firmware incorrectly or using the wrong update can permanently damage the chipset on the DVR and render it unusable. Updates are written to either resolve issues or add features to the DVR. If you are not experiencing performance issues or do not need a feature added by the update, we recommend not running the update.

### 7.1 CONNECTING A PTZ CAMERA

All QT-Series DVRs can support one or more Pan/Tilt/Zoom, or PTZ cameras. These cameras connect to the DVR through the same ports as a conventional camera, but the control wires connect through the RS485 block on the back of the DVR. **Picture 7-1**, below, is only a representation and your actual connector may look different. Please consult **Chapter 2 Connections and Controls** to find the diagram representing your model for the location of your connector block.

The RS485 connector uses a single-direction protocol meaning that it can send commands out to the camera(s) but not receive any data back from the unit meaning that video images will be delivered through the video cable as with any other camera.

The DVR is set by default for RS485 to be disabled for each channel. Therefore, PTZ settings must be enabled before PTZ cameras can be utilized. This system supports 26 of the most common protocols including Pelco-D and Pelco-P.

When connecting a PTZ camera, the following should be taken into account:

- The 485 port of this DVR cannot parallel connect with the 485 port of another device
- The voltage between the A and B lines of the camera should be less than 5V.

**STEP 1.** The data cable from the PTZ camera must be connected to the ports highlighted in **Picture 7-1**. Multiple PTZ cameras can be connected to this port, but you may require an expander port to do so.

**STEP 2.** Connect the other end of the cable to the proper pins in the connector on the camera

**STEP 3.** Connect the camera video and power cables as you would any other camera.

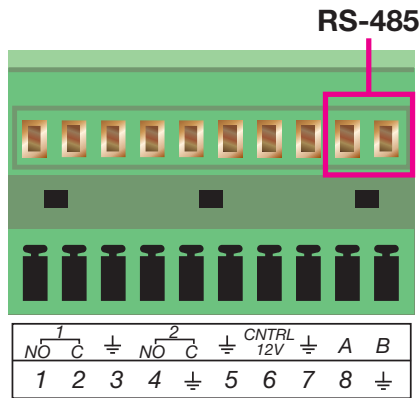

**PICTURE 7-1**

### 7.2 PAN-TILT-ZOOM (PTZ) CONFIGURATION

If you are connecting optional Pan-Tilt-Zoom cameras, the controls are set from this window in the **Serial Port** and **Advanced** tabs.

#### Serial Port Tab

You will need to consult your PTZ camera's manual for details regarding protocol and baud rate. Please note that the DVR may support more features than your camera offers including protocol and number of preset programs.

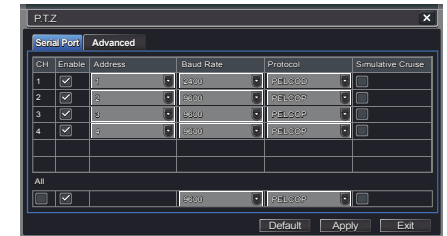

**PICTURE 7-2**

Cameras can be individually configured or a global set-up can be implemented through the **All** button.

Simulative Cruise is for use with PTZ cameras using an unsupported protocol to allow you to use at least some of the features.

#### PTZ Definitions and Descriptions:

Parameter	Settings	What it Means
Address	1-255	The address of the PTZ camera
Baud Rate	110-21600	The speed that data is transmitted
Protocol		The communication protocol used by the camera. Supported protocols are; NULL, PELCOP, PELCOD, LILIN, MINKING, NEON, STAR, VIDO, DSCP, VISCA, SAMSUNG, RM110, HY

#### Advanced Tab

You can set your camera to follow a preset program or set cruising or tracking behaviors by selecting the **Setting** button in the **Preset**, **Cruise** or **Track** columns respectively.

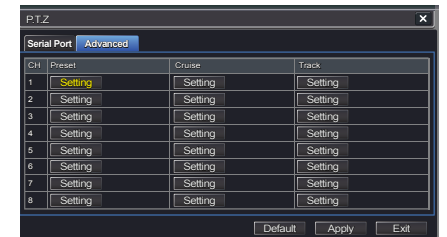

**PICTURE 7-3**

## Preset

Clicking a **Setting** button in the **Preset** column will bring up another window

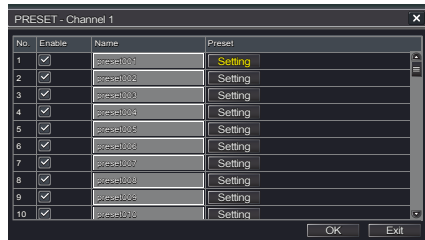

PICTURE 7-4

And, selecting **Setting** will bring up the camera view along with a control panel to program the camera's motion.

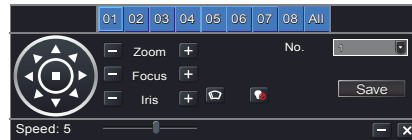

PICTURE 7-5

The dome's rotation can be controlled vertically, horizontally and diagonally along with its speed. The lens zoom, focus and iris (light level) can be set as well. Select the number you want to assign to this set of actions and click the **Save** button to save your preset. You can hide the control panel by clicking on the "-" button or right-clicking on the screen. The control panel can be unhidden by right-clicking on the screen again. The **X** button will exit the control interface.

## Cruise

Selecting a **Setting** button from the **Cruise** column will open the **Cruise** window.

Select **Add** or double-click on an existing line to modify and the **CRUISE PRESET** window will open.

**Delete** will remove a selected cruise line

**Clear All** will remove all of the cruise lines.

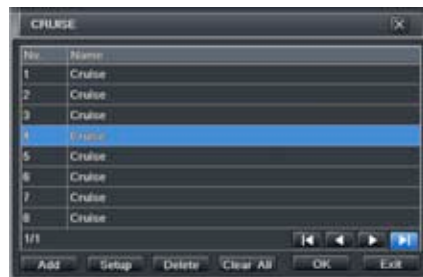

PICTURE 7-6

The set of icons to the right of the screen are used to configure each cruise setting.

**Preview** – Preview the cruise to ensure that you have the desired results.

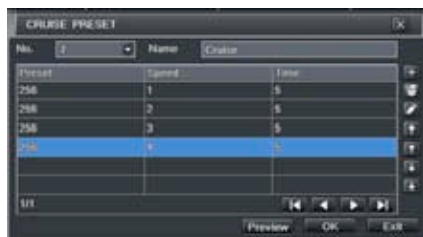

PICTURE 7-7

Name	Symbol	What it Does
Add		Opens a window to allow the user to set the speed and time of a new preset point
Delete		Deletes a preset point
Modify		Opens the settings window for the selected preset point allowing you to change the settings
Arrows		Enables the user to alter the position of a setting in the cruise order.
		Move a preset point all the way to the top of the order
		Move a preset point up one position in the list
		Move a preset point down one position in the list
		Move a preset point to the bottom of the order

## Track

This interface is used to program the tracking routine for the camera. Clicking on the **Track** button will bring up the live view for that camera plus a control panel:



PICTURE 7-8

The user can control the dome's rotation direction, plus speed as well as the zoom, focus and iris.

**Start Record** – The system will begin recording the sequence of movements you perform on the PTZ control panel. Clicking this again will stop the recording.

**Start Track** – This will play back the tracking sequence you just recorded. Clicking on this button again will stop the playback.

Many QT Series DVRs feature connections for external alarms – both input and output. Please consult **Chapter 2 Connections and Controls** to determine whether your model includes this feature and where the connection block is located. The alarm connector block shown in **Picture 8-1** is only a representation and your actual connector may look different.

When an event is detected the system can notify local users or send notification to a monitoring service. At the same time, the system can accept signals from motion detectors, smoke detectors or other alarms and begin recording based on that input and your settings. You will need to have the manual for your alarm(s) handy to ensure the proper settings within the DVR.

### 8.1 ALARM INPUT

When attaching alarms, the following criteria must be met:

1. The alarm input must be grounded.
2. A grounding signal is required for the alarm input
3. When connecting the DVR to another device - including another DVR - through the alarm input, a relay should be used to separate them.

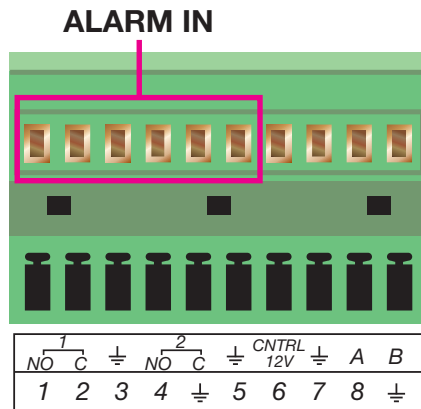

**PICTURE 8-1**

Parameter	Grounding Alarm
	Ground line
Alarm Input	1, 2, ..., 8 becomes valid in low voltage.
1-NO C 2-NO C	Two NO activation outputs.
CTRL 12V	Controls the power output You need to close the device power to cancel the alarm.

The accompanying diagram (**Picture 8-2**), along with your alarm's manual should be consulted to ensure proper connection.

- Normal open or Normal close type
- Parallel connect COM end and GND end of the alarm detector (Provide external power to the alarm detector).
- Parallel connect the Ground of the combo DVR and the ground of the alarm detector.
- Connect the NC port of the alarm sensor to the combo DVR alarm input(ALARM)
- Use the same ground with that of combo DVR if you use external power to the alarm device.

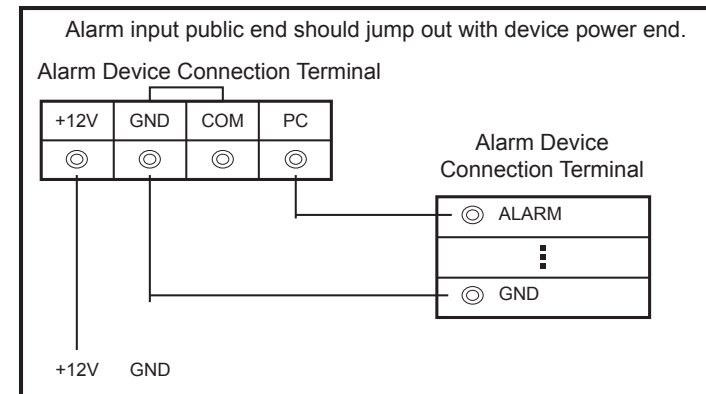

**PICTURE 8-2**

## 8.2 ALARM OUTPUT

The alarm output port should not be directly connected to a higher power load (greater than 1A) to avoid high current which may damage the relay. Use the co-contactor to establish the connection between the alarm output port and the load.

- 2 way relay alarm output (NO contact). Provides external power to external alarm device.
- To avoid overloading, please read the following relay parameters sheet carefully.
- RS485 A/B cable is for the A/B cable of the PTZ camera(s).

**Relay Specification**

Model:	JRC-27F	
Material of the contact	Silver	
Rating (Resistance Load)	Rated switch capacity	30VDC 2A, 125VAC 1A
	Maximum switch power	125VA 160W
	Maximum switch voltage	250VAC, 220VDC
	Maximum switch current	1A
Insulation	Between contacts with same polarity	1000VAC 1minute
	Between contacts with different polarity	1000VAC 1minute
	Between contacts and winding	1000VAC 1minute
Surge voltage	Between contacts with same polarity	1500V (10×160us)
Length of open time	3ms max	
Length of close time	3ms max	
Longevity	Mechanical	50×106 times (3Hz)
	Electrical	200×103 times (0.5Hz)
Temperature	-40°C ~+70°C (-40°F to +158°F)	

## 8.3 ALARM CONFIGURATION

Alarm configuration allows the DVR to begin recording based on input from other remote sensors such as infrared motion detectors or contact alarms which are connected to it.

There are five submenus; **Sensor**, **Motion**, **Video Loss**, **Other**, and **Alarm Out**.

### SENSOR

In this window you can setup optional external sensors to cause the DVR to begin recording. There are three tabs in this window: **Basic**, **Alarm Handling** and **Schedule**.

#### Basic Tab

This allows you to enable the input from attached sensors. You can also identify the sensors by name for ease in determining location.

Set the alarm type according to whether the alarm is NO (Normally Open) or NC (Normally Closed). See your alarm's manual for details.

Alarms can be individually configured or globally set using the **All** button.



**PICTURE 8-3**

#### Alarm Handling Tab

Configure how you want the DVR to handle the input from an activated alarm. Each sensor input can be set to launch individual sequences of action or they may be globally set through the **All** button to have the same results.

**Hold Time:** determines the time allowed between consecutive alarm events. If the alarm is triggered again within this time, it will be treated as a single event and the DVR will continue recording before stopping.

**Trigger:** This is what the DVR will do once activated by an alarm. Selecting **Setting** will open a new window with three tabs; **Alarm**, **To Record**, **To PTZ**

**Alarm** allows you to set whether a buzzer will sound, which camera (if any) will display in full screen mode, whether an e-mail will be sent and whether a signal will be sent via the ALARM OUT port.



**PICTURE 8-4**



**PICTURE 8-5**



**To Record** allows you to determine which cameras will begin recording. Cameras can be set to record individually, in blocks, or all cameras can be activated.

**To PTZ** activates preset, cruise or track functions on selected Pan-Tilt-Zoom cameras. Depending on your model of PTZ camera, one of up to 128 pre-set actions can be engaged. Check your camera's manual for details.

### Schedule Tab

Set by default to always on, the schedule can be altered in the same manner as that used in **Schedule** in **SECTION 4.4**.



PICTURE 8-6

## MOTION

### Motion Tab

As with the **Alarm** function above, it incorporates hold time and can trigger procedures.

Select which cameras you wish to start recording on motion detection. Set the holding time which determines the length of time the cameras continue recording after motion stops.

In the **Trigger** setting, you can set multiple channels to record when motion is detected by a camera that has been set to activate upon motion detection.

**For example:** If Camera 1 detects motion, you can have it trigger Cameras 2 and 3 to begin recording as well.

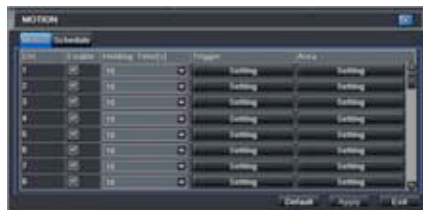

PICTURE 8-7

In addition, the user can set the sensitivity of certain areas within the field of view by clicking on the **Select** button selecting the **Area** field for the respective camera.

Specific areas can be made sensitive by applying a blue grid to the desired section of the screen. The blue grid can be applied to the entire screen – signifying that the entire field of view is sensitive - by clicking on the **star button**. The **trash can** button will remove the grid completely. Click and drag with the mouse on the screen to draw or erase the grid in select areas.



PICTURE 8-8

As sensitivity is influenced by color and light level, you can adjust its values according to your specific conditions. The default value is "4." A setting of "8" is most sensitive while a setting of "1" is minimally sensitive.

Right-clicking in the screen will show or hide the control menu at the bottom of the screen.

Test your settings by moving something or someone through the grid area in the camera's view. Motion should not be detected outside of this area but you should see a yellow humanoid figure appear in the screen once the DVR detects movement within the grid. Removing the grid where there is a flag or trees that frequently move in the wind will prevent false alerts. Click on the **Disk** button to save your settings before exiting the setup process by clicking on the **X** button.



PICTURE 8-9

### Schedule Tab

This is also set to be on all the time by default and it can be adjusted in the same manner as the **Schedule** configuration in **SECTION 4.4**.



PICTURE 8-10

## VIDEO LOSS

In the event that signal is lost by one camera, others can be activated to record while additional devices can also be triggered.

Like the **Trigger** tab in the **Alarm Handling** section of the **Sensor** menu, you can select the events that you wish to occur in the event that a video input is lost. Both Alarms and PTZ events can be scheduled as in the **Sensor** menu above.



PICTURE 8-11

## OTHER ALARM

In this menu you can set the DVR to alert you to a full Hard Drive, IP Conflict on the network or a Disconnection.

You can set the disk response as well as at what threshold of remaining disk space you wish to be alerted.

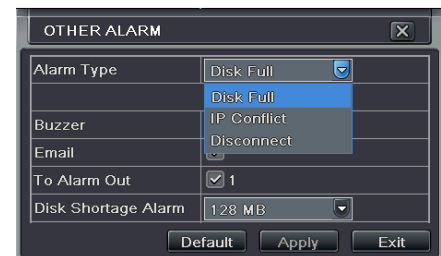

PICTURE 8-12

## ALARM OUT

Set how the alarms are handled and transmitted in this window. This controls any device attached to the ALARM OUT port on the back of the DVR. There are three tabs; **Alarm Out**, **Schedule** and **Buzzer**.

### Alarm Out Tab

You can set the relay alarm out name as well as the hold time. Hold time is the interval between consecutive alarm activations so multiple events within the interval will not cause the alarm to sound again.



PICTURE 8-13

### Schedule Tab

The default setting is for the ALARM OUT to be active all the time, but this can be changed to meet your particular requirements in a similar manner to **Schedule** in SECTION 4.4.

### Buzzer Tab

As with the **Alarm Out** hold time, the internal buzzer can be enabled and given a hold time.

## HARD DISK DRIVE

Your DVR uses a standard desktop or 3.5" SATA (Serial Advanced Technology Attachment) hard disk drive and will support drives up to 2TB (terabytes). These drives are the current industry standard and may be purchased wherever computer parts are sold. Depending on where you purchased your DVR, your hard drive may already be installed. But, we recognize that you may wish to upgrade or replace your drive in the future so this DVR is designed to make installation and replacement easy for the average user. A 5400RPM drive will work but a 7200RPM drive is recommended for optimal performance.

It should be noted that while this is the only user-serviceable part within the case besides the battery and you will not void your warranty by installing or upgrading your hard disk drive, care must be taken to avoid damage to the other components within the case. Such damage will not be covered.



### WARNING! ELECTRIC SHOCK RISK!

The DVR **MUST** be unplugged from all power sources as well as from the cameras before opening the case. Failure to do so can result in damage to the DVR or its components as well as injury or death.



### 9.1 INSTALLATION/REMOVAL

It is strongly advised against opening the case when atmospheric conditions present the risk of static discharge which can damage electronic components.

Whether installing the drive for the first time or removing the old one to install a new one, the steps are largely the same:

- STEP 1.** Disconnect the DVR from the power source as well as any other connections.
- STEP 2.** Remove screws (the number will vary depending on your model) from the side and rear of your DVR as indicated in **Picture 9-1**

### Remove Screws

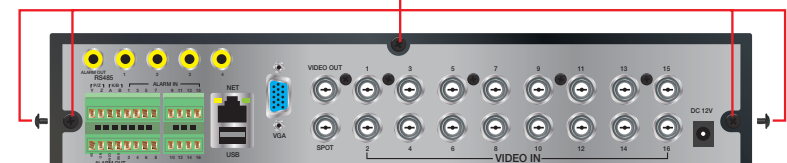

PICTURE 9-1

- STEP 3.** Remove the case by sliding it backwards and then lifting off.
- STEP 3A.** If removing a hard drive, you will need to unscrew the four drive mounting screws at the bottom of the DVR or on the internal mounting rack.

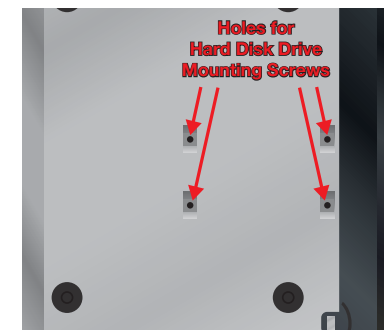

PICTURE 9-2

**STEP 4.** Connect the power and data cables. Press firmly, but do not force them onto the pins or you may damage them. The connectors are “keyed” to ensure they are connected in the proper position.

**STEP 5.** Attach hard drive to the base of the DVR with screws using the four mounting holes.

**STEP 6.** Replace the DVR cover and secure.

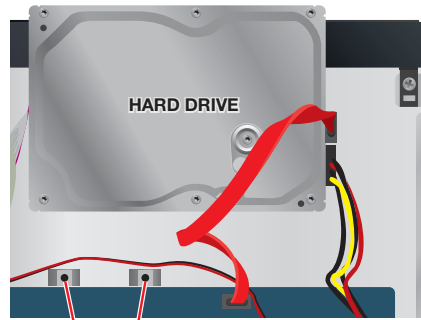

**MOUNTING HOLES FOR HARD DRIVE DATA CABLE POWER CABLE**

**PICTURE 9-3**

## 9.2 CALCULATING THE RECORDING CAPACITY OF A HARD DISK DRIVE

While the physical data capacity of a hard drive is fixed, how much video you can record upon it depends on your recording configurations. Higher quality recordings will take up more space on the drive and setting the DVR to record for more frequently will fill it up more rapidly.

To determine the optimal capacity for your purposes, the chart below to estimate the size of hard drive that you'll need.

VIDEO FORMAT	RESOLUTION	FRAME RATE (FPS)	VIDEO QUALITY	BIT RATE (kbps)	SPACE USED (MB/h)	
NTSC	CIF	30	Highest	1000k	465	
			Higher	768k	297	
			Medium	512k	230	
			Low	384k	173	
			Lower	256k	115	
		Lowest	128k	56		
		D1	7.5	Highest	500k	228
	Higher			375k	128	
	Medium			250k	117	
	Lower			192k	75	
Lowest	128k			61		
PAL	CIF	25	Highest	1000k	466	
			Higher	768k	295	
			Medium	512k	235	
			Low	384k	175	
			Lower	256k	112	
		Lowest	128k	56.4		
		D1	7.5	Highest	500k	228
	Higher			375k	128	
	Medium			250k	117	
	Lower			192k	75	
Lowest	128k			61		

The formula for calculating the required disk space is:

**Total Recording Capacity = Used space per hour (MB/h) x Recording time (hour) x number of channels**

Example: A customer is using the NTSC format (30 frames per second), CIF resolution with video quality set to Lowest and a total of 16 Channels. He wants the unit to record continuously for a month. Therefore, the calculation will look like this:

**56(MB/h), x 24 (hours/day) x 30 (days) x 16 (channels) = 645,120MB or 650GB**

Installing a 750GB SATA hard drive should provide enough space for one month's continuous recording time at those settings.

# APPENDIX

## A.1 TROUBLESHOOTING

### 1. The DVR does not start after connecting the power, what is wrong?

- The power adapter may have been damaged, or is not providing enough power. Please change the adapter.
- The DVR may not be getting enough power from the outlet or surge protector it is attached to.
- There could be a problem with the system board on the DVR

### 2. The indicator lights of the DVR are on, but no output. Why?

- The power adapter may have been damaged, or is not providing enough power. Please change the adapter
- The video format of the DVR is different from that of the monitor.
- Connection problem. Please check the cable and the ports of the monitor and DVR.

### 3. Why are no images displayed on some or all of the channels of the DVR?

- Connection problem. Please check the cables and the ports of camera and DVR.
- Camera problem. Please check the cameras by attaching them directly to TV or working port on DVR.
- The video format (NTSC/PAL) of the DVR is different from that of the cameras. Please change DVR video format.

### 4. The DVR cannot find the hard disk drive.

- The power adapter is not providing enough power, or the adapter is not getting enough power from the outlet
- Connection problem. Please check the power and data cables on the HDD.
- The HDD is damaged and will need to be replaced.

### 5. I cannot record, what could be the problem?

- The HDD is not formatted. Please format it manually first.
- The record function is not enabled or setup correctly. Please refer to **Section 4.3 Record Configuration**.
- The HDD is full and recycle function is not enabled. Please refer to **Section 4.3 Record Configuration** and the **Recycle Record Tab** in the **Record Menu**.
- The HDD is damaged and will need to be replaced.

### 6. I cannot use the mouse, what could be the problem?

- Wait 5 minutes after connecting the mouse and then try again.
- The mouse is not securely connected. Plug/unplug several times.
- The mouse is incompatible with the system. Please try another mouse.

### 7. What can I do when the DVR starts and displays "please wait....."all the time?

- First possible reason: hard drive power cable and/or data cable are not securely connected.  
**Solution:** Please check the cable connections and make sure they are secure; if still not working, please unplug them and then plug them in again.
- Second possible reason: The system is having problems reading the hard drive.  
**Solution:** Try reformatting the current drive or re-placing it.
- Solution:** Try connecting the DVR to a different surge protector and power outlet.

### 8. How do I input letters and numbers?

To input letters (such as passwords) and numbers click the box behind where text is to be entered, and then a small keyboard will appear. Please select number or letter to input (the default password is **123456**), or you can use the digital keys on the front panel, or the digital keys on the remote control.

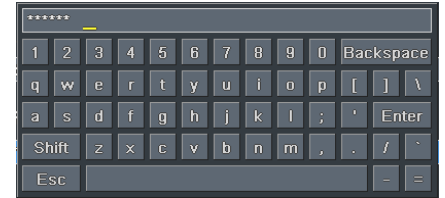

PICTURE A-1

### 9. How do I upgrade the firmware on the DVR?

After you download the new firmware from the Q-See website at [www.Q-See.com/Support](http://www.Q-See.com/) and copy it onto a USB flash drive. Then select **Upgrade** in the menu.



**WARNING!** Do not turn the system power off during the upgrade process! Doing so may damage the chipset and prevent the DVR from starting.

### 10. I can get a live image on the display but I can't get the menu to display. How can I pull up the menu?

Hold down the **ESC** key to wait for login dialog box to appear.

### 11. I hooked the DVR up to a TV through the BNC video out port and I do not see anything on the screen. How do I get the video to display?

By default the DVR is setup to use a VGA monitor, if you want to use a TV instead then push the **ESC** button on the front panel and hold it until you hear a beep, if you still do not get a display then hold the **ESC** button down again until you hear a beep, the display should come up.

### 12. What is the minimum configuration of a PC for remote connection?

COMPONENT	MINIMUM REQUIRED
CPU	Intel Celeron 2.4G
MOTHERBOARD	Intel 845
HDD	80G
RAM	1GB
VGA	512MB Video RAM NVIDIA GeForce MX440/FX5200 ATIRADEON 7500/X300
OS	Windows XP(SP2 above) /VISTA/Win7
DIRECTX	9.0

13. What are the PC configurations for 16-channel real time access with fully open mainstream channel?

PC MODULE	PARAMETERS
CPU	Intel Core(TM)2 Duo CPU E4600
MOTHERBOARD	G41/P41 chip
HDD	80G
RAM	1GB
VGA	GMA3100/NVIDIA GeForce 8400/ ATI RADEON HD3450, 512MB Video RAM
OS	Windows XP(SP2 above)/ VISTA/Win7,
DIRECTX	9.0

14. On Vista and Win7 I am getting an error message that Codec can't be installed or is missing, how do I solve that?

There are two ways to fix it:

- a. In Windows, go to your **Control Panel** select **User Account and Family Safety** and then choose **User Account Control**.

Click **Turn User Account On or Off**. Uncheck the box next to **Use User Account Control (UAC) to help protect your computer**.

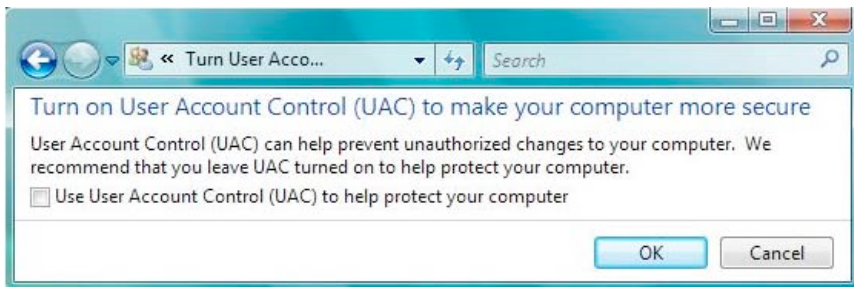

PICTURE A-2

- b. Right-click on an Internet Explorer browser window. Select **Run as Administrator** to run browser.

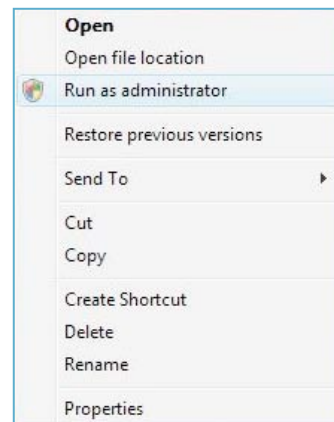

PICTURE A-3

## A.2 SPECIFICATIONS

Parameter		QT454	QT426	QT428
COMPRESSION	Compression Format	Standard H.264 Baseline		
VIDEO	Video In	Composite 1.0V p-p/75Ω, BNC x 4	Composite 1.0V p-p/75Ω, BNC x 16	Composite 1.0V p-p/75Ω, BNC x 8
	Video Out	COMPOSITE 1.0V p-p/75Ω, BNC x 2, VGA x 1		
	VGA Resolution	1280x1024, 1024x768, 800x600		
	Record Resolution	NTSC: 352x240, 704x480 PAL: 352x288, 704x576		
	Display Frame Rate (per camera)	704x480 at 30FPS		
	Record Frame Rate (per camera)	NTSC: D1 7.5FPS CIF 30FPS PAL: D1 6.25FPS CIF 25FPS		
AUDIO	Audio Input	-8dB~ 22k, RCA X4		
	Audio Output	-8dB~92dB, RCA X1		
ALARM	Alarm Input	NO or NC 4CH	NO or NC 16CH	NO or NC 8CH
	Alarm Output	1CH		
STORAGE	Record Mode	Manual/Sensor/Timer/Motion Detection		
	Multi-Function	Multiplex		
INTERFACE	Network Interface	RJ45 (LAN, Internet)		
	Communication Interface	RS485, USB 2.0 x 2 (One for Backup, One for USB Mouse)		
CONTROLS	PTZ Control	Yes		
	Remote Control	Yes		
DISK INFO	Disk Type	SATA x 1 (up to 2TB)		
OTHER INFO	Voltage	12V3A	12V4A	12V4A
	Optimal Temperature	50°F to 104°F 10°C to 40°C 10% to 90% Humidity		
	Power Consumption	10W	20W	10W

Parameter		QT474	QT446	QT4332
COMPRESSION	Compression Format	Standard H.264 Baseline		
VIDEO	Video In	Composite 1.0V p-p/75Ω, BNC x 4	Composite 1.0V p-p/75Ω, BNC x 16	Composite 1.0V p-p/75Ω, BNC x 32
	Video Out	COMPOSITE 1.0V p-p/75Ω, BNC x 1, VGA x 1	COMPOSITE 1.0V p-p/75Ω, BNC x 1, VGA x 1 Loop Out x 2	COMPOSITE 1.0V p-p/75Ω, BNC x 1, VGA x 1, HDMI x 1
	VGA Resolution	1280x1024, 1024x768, 800x600		1920x1080 1280x1024, 1024x768, 800x600
	Record Resolution	NTSC: 352x240, 704x480 PAL: 352x288, 704x576		
	Display Frame Rate (per camera)	704x480 at 30FPS		
Record Frame Rate (per camera)	NTSC: D1 7.5FPS CIF 30FPS PAL: D1 6.25FPS CIF 25FPS		NTSC: D1 7.5FPS CIF 30FPS 4CH D1 30FPS if others CIF PAL: D1 6.25FPS CIF 25FPS	
AUDIO	Audio Input	-8dB~ 22k, RCA X2	-8dB~ 22k, RCA X16	-8dB~ 22k, RCA X16
	Audio Output	-8dB~92dB, BNC X1	-8dB~92dB, RCA X1	-8dB~92dB, RCA X1
ALARM	Alarm Input	0	NO or NC 16CH	NO or NC 16CH
	Alarm Output	0	1CH	4CH
STORAGE	Record Mode	Manual/Sensor/Timer/Motion Detection		
	Multi-Function	Multiplex		
INTERFACE	Network Interface	RJ45 (LAN, Internet)		
	Communication Interface	RS485, USB 2.0 x 2 (One for Backup, One for USB Mouse)	eSATA x2 RS485, USB 2.0 x 2 (One for Backup, One for USB Mouse)	
CONTROLS	PTZ Control	Yes		
	Remote Control	Yes		
DISK INFO	Disk Type	SATA x 1 (up to 2TB)	SATA x 4 (up to 2TB each)	SATA x 4 (up to 2TB each)
OTHER INFO	Voltage	12V3A	110/220	
	Optimal Temperature	50°F to 104°F 10°C to 40°C 10% to 90% Humidity		
	Power Consumption	10W	22W	42W

Parameter		QT4532	QT2124	
COMPRESSION	Compression Format	Standard H.264 Baseline		
VIDEO	Video In	Composite 1.0V p-p/75Ω, BNC x 32	Composite 1.0V p-p/75Ω, BNC x 24	
	Video Out	COMPOSITE 1.0V p-p/75Ω, BNC x 1, VGA x 1, HDMI x 1	COMPOSITE 1.0V p-p/75Ω, BNC x 2, VGA x 1	
	VGA Resolution	1920x1080 1280x1024, 1024x768, 800x600	1280x1024, 1024x768, 800x600	
	Record Resolution	NTSC: 352x240, 704x480 PAL: 352x288, 704x576		
	Display Frame Rate (per camera)	704x480 at 30FPS		
Record Frame Rate (per camera)	NTSC: D1 7.5FPS CIF 30FPS 4CH D1 30FPS if others CIF PAL: D1 6.25FPS CIF 25FPS	NTSC: CIF 30FPS PAL: CIF 25FPS		
AUDIO	Audio Input	-8dB~ 22k, RCA X16	-8dB~ 22k, RCA X4	
	Audio Output	-8dB~92dB, RCA X1	-8dB~92dB, RCA X1	
ALARM	Alarm Input	NO or NC 16CH		
	Alarm Output	4CH	1CH	
STORAGE	Record Mode	Manual/Sensor/Timer/Motion Detection		
	Multi-Function	Multiplex		
INTERFACE	Network Interface	RJ45 (LAN, Internet)		
	Communication Interface	eSATA x2 RS485, USB 2.0 x 2 (One for Backup, One for USB Mouse)	RS485, USB 2.0 x 2 (One for Backup, One for USB Mouse)	
CONTROLS	PTZ Control	Yes		
	Remote Control	Yes		
DISK INFO	Disk Type	SATA x 8 (up to 2TB each)	SATA x 2 (up to 2TB each)	
OTHER INFO	Voltage	110/220	12V5A	
	Optimal Temperature	50°F to 104°F 10°C to 40°C 10% to 90% Humidity		
	Power Consumption	42W	40W	

Parameter	QT528	QT526	QT504	
COMPRESSION	Compression Format	Standard H.264 Baseline		
VIDEO	Video In	Composite 1.0V p-p/75Ω, BNC x 8	Composite 1.0V p-p/75Ω, BNC x 16	Composite 1.0V p-p/75Ω, BNC x 4
	Video Out	COMPOSITE 1.0V p-p/75Ω, BNC x 2, VGA x 1		
	VGA Resolution	1280x1024, 1024x768, 800x600		
	Record Resolution	NTSC: 352x240, 704x480 PAL: 352x288, 704x576		
	Display Frame Rate (per camera)	704x480 at 30FPS		
	Record Frame Rate (per camera)	NTSC: D1 30FPS CIF 30FPS PAL: D1 25FPS CIF 25FPS		
AUDIO	Audio Input	-8dB~ 22k, RCA X4		
	Audio Output	-8dB~92dB, RCA X1		
ALARM	Alarm Input	NO or NC 8CH	NO or NC 16CH	NO or NC 4CH
	Alarm Output	1CH		
FUNCTION	Record Mode	Manual/Sensor/Timer/Motion Detection		
	Multi-Function	Simultaneously Record, View Live or Recorded Video, Playback, Back-up files, Monitor Remotely		
INTERFACE	Network Interface	RJ45 (LAN, Internet)		
	Communication Interface	RS485, USB 2.0 x 2 (One for Backup, One for USB Mouse)		
CONTROLS	PTZ Control	Yes		
	Remote Control	Yes		
DISK INFO	Disk Type	SATA x 2 (up to 2TB each)		SATA x 1 (up to 2TB)
OTHER INFO	Voltage	12V4A	12V5A	12V3A
	Optimal Temperature	32°F to 122°F 10°C to 50°C 10% to 90% Humidity		
	Average Power Consumption	18W	30W	10W

Parameter	QT518	QT5116	QT536		
COMPRESSION	Compression Format	Standard H.264 Baseline			
VIDEO	Video In	Composite 1.0V p-p/75Ω, BNC x 8	Composite 1.0V p-p/75Ω, BNC x 16	Composite 1.0V p-p/75Ω, BNC x 16	
	Video Out	COMPOSITE 1.0V p-p/75Ω, BNC x 2, VGA x 1, HDMI, Loopout x 8	COMPOSITE 1.0V p-p/75Ω, BNC x 2, VGA x 1, HDMI, Loopout x 8	COMPOSITE 1.0V p-p/75Ω, BNC x 2, VGA x 1, HDMI, Loopout x 16	
	VGA Resolution	1920x1080, 1280x1024, 1024x768, 800x600			
	Record Resolution	NTSC: 352x240, 704x480 PAL: 352x288, 704x576			
	Display Frame Rate (per camera)	704x480 at 30FPS			
	Record Frame Rate (per camera)	NTSC: D1 30FPS CIF 30FPS PAL: D1 25FPS CIF 25FPS			
	AUDIO	Audio Input	-8dB~ 22k, RCA X8	-8dB~ 22k, RCA X16	-8dB~ 22k, RCA X16
		Audio Output	-8dB~92dB, RCA X4		-8dB~92dB, RCA X1
ALARM	Alarm Input	NO or NC 8CH	NO or NC 16CH	NO or NC 16CH	
	Alarm Output	4CH	4CH	4CH	
FUNCTION	Record Mode	Manual/Sensor/Timer/Motion Detection			
	Multi-Function	Simultaneously Record, View Live or Recorded Video, Playback, Back-up files, Monitor Remotely			
INTERFACE	Network Interface	RJ45 (LAN, Internet)			
	Communication Interface	RS485, eSATA, Microphone USB 2.0 x 2 (One for Backup, One for USB Mouse)		RS485, eSATA x 2, Microphone USB 2.0 x 2 (One for Backup, One for USB Mouse)	
CONTROLS	PTZ Control	Yes			
	Remote Control	Yes			
DISK INFO	Disk Type	SATA x 3 (up to 2TB each)		SATA x 8 (up to 2TB each)	
OTHER INFO	Voltage	110/230V			
	Optimal Temperature	50°F to 104°F 10°C to 40°C 10% to 90% Humidity			
	Average Power Consumption	22W	36W	50W	

### A.3 RACK MOUNTING

The QT446, QT4332, QT4532, QT518, QT5116 and QT536 all use 2U cases and include brackets and screws allowing them to be secured in a standard server rack or server cabinet. These DVRs are designed for **horizontal mounting only**.

The DVR must rest on a shelf sufficient to hold its weight. The included mounting brackets are only intended to keep the system from shifting and they are not sufficient to suspend the DVR alone. You will also need to provide bolts to attach the brackets to the rack.

Two mounting brackets and four screws are contained in the accessory box that accompanied your DVR. Some brackets will have three holes but only two screws are required to mount the bracket to the DVR.



The flanges to secure the DVR to the rack should be towards the front.



The DVR must have sufficient support when installed. The brackets are only to keep the DVR from moving. Ensure that all four holes on the two mounting brackets line up with holes in the rack.

If you will have limited access to the back of the DVR, it is best to make sure that all camera and other cable connections on the back of the DVR are secure before bolting the brackets to the rack.



## Q-SEE PRODUCT WARRANTY

Q-See is proud to back all of our products with a conditional service warranty covering all hardware for 12 months from the date of purchase. Additionally, our products also come with a free exchange policy that covers all manufacturing defects for one month from the date of purchase. Permanent upgrading service is provided for the software.

### Liability Exclusions:

Any product malfunction or abnormalities in operation or damage caused by the following reasons are not within the free service scope of our company:

1. Equipment damage caused by improper operation.
2. Improper equipment operation environment and conditions (e.g., improper power, extreme environmental temperatures, humidity, lightning and sudden surges of electricity).
3. Damage caused by acts of nature (e.g., earthquake, fire, etc).
4. Equipment damage caused by the maintenance of personnel not authorized by Q-See.
5. Product sold over 12 months ago.

In order to fulfill the terms of your warranty, you must complete the registration process after purchasing our product. To do this, simply fill out the User's Information Card on our website at [www.Q-See.com](http://www.Q-See.com)





**QUESTIONS OR COMMENTS? CONTACT US**

**PRODUCT SUPPORT, DOWNLOADS,  
FIRMWARE UPDATES & MANUALS**

24/7 Technical Resources

Live Chat (M-F, 9-5 PST)

[www.Q-See.com/Support](http://www.Q-See.com/Support)

simplicity - quality - technology



Digital Peripheral Solutions, Inc.

8015 E. Crystal Drive

Anaheim, CA 92807

## Free Manuals Download Website

<http://myh66.com>

<http://usermanuals.us>

<http://www.somanuals.com>

<http://www.4manuals.cc>

<http://www.manual-lib.com>

<http://www.404manual.com>

<http://www.luxmanual.com>

<http://aubethermostatmanual.com>

Golf course search by state

<http://golfingnear.com>

Email search by domain

<http://emailbydomain.com>

Auto manuals search

<http://auto.somanuals.com>

TV manuals search

<http://tv.somanuals.com>