



Commercial Series Net DVR

User Manual

(V2.0)

Thank you for purchasing our embedded Net DVR. This manual is applicable for QSD42208, QSC26408, and QSC26416 Net DVR, as well as the QSF2648008 and QSF2648016 Enterprise DVR models. Please read this User Manual carefully to ensure that you can use the device correctly and safely.

DISCLAIMER: The contents of this Manual are subject to change without notice; we are also not responsible for typing errors or errors of omission.

Contact Us:

Q-See Products

8015 E. Crystal Dr
Anaheim, CA 92807

Website:

<http://www.q-see.com>

Customer Service:

Phone: 877-998-3440 x 538

Email: cs@dpsi-usa.com

Tech Support:

Phone: 877-998-3440 x 539

Email: ts@dpsi-usa.com

Fax:

714-998-3509

Rev 082907D

Index

Version Description.....	4
Chapter 1 Product Introduction.....	6
1.1 Summary	6
1.2 Features	6
Chapter 2 Installation.....	8
2.1 Checking the DVR and Its Accessories.....	8
2.2 HDD Installation	8
2.3 Rear Panel Description.....	9
2.3.1 8-ch QSD42208 Rear Panel	9
2.3.2 8-ch/16-ch QSC26408/16 Rear Panel	10
2.4 External Alarm In/Out Connection	12
Chapter 3 Operational Instructions	13
3.1.1 8-ch QSD42208 Front Panel	13
3.1.2 8-ch QSC26408 Front Panel	15
3.1.3 16-ch QSC26416 Front Panel	17
3.2 Remote Control	19
3.3 Menu Description.....	21
3.3.1 Menu Items.....	21
3.3.2 Menu Operation	22
3.4 Character Input.....	25
Chapter 4 Basic Operation Guide	26
4.1 Power on	26
4.2 Preview.....	26
4.3 User name and password.....	29
4.4 PTZ Control	31
4.5 Manual Record.....	33
4.6 Playback	34
4.7 Backup Recorded Files	39
4.8 Shut Down DVR	41
Chapter 5 Main and Aux Output Function.....	43
5.1 Main and aux output.....	43
5.2 Main and Aux output preview	44
5.3 Main and Aux output playback	47
5.4 Main or Aux output to control PTZ.....	48
Chapter 6 Parameters Setup Guide	49
6.1 Administrator and Password	49
6.2 Add and Delete User	51
6.3 Unit Name and Device ID.....	54
6.4 Video Output Standard and VGA Setup.....	55
6.5 OSD Setup.....	56
6.6 Video Parameters Setup	59

6.7	Mask Area Setup	60
6.8	View Tampering Alarm	62
6.9	Video Loss Alarm.....	64
6.10	Motion Detection Alarm	66
6.11	Preview Properties	69
6.12	Recording Setup.....	71
6.13	External Alarm Input and Relay Output.....	75
6.14	Network Parameters	79
6.141	Accessing the DVR over a network.....	81
6.142	Accessing the DVR from a remote computer	82
6.15	PTZ	83
6.16	RS232 setup	87
6.17	Exceptions	92
6.18	Transaction Information.....	93
Chapter 7	Utilities.....	97
7.1	Save Parameters	97
7.2	Restore Parameters.....	97
7.3	Upgrade.....	98
7.4	Hard Disk Management	99
7.5	Clear Alarm Out	99
7.6	Reboot	99
7.7	Power Off.....	99
7.8	View Log.....	99
7.9	System Information.....	102
Chapter 8	Firmware Upgrade	103
8.1	FTP Server Setup	103
8.2	Upgrade Mode.....	105
Appendix A	HDD Capacity Calculation.....	106
Appendix B	DVR Connect Cable Definition	107
1	How to make a RS-485 connect cable	107
2	How to make a UTP network connect cable	107
3	How to make a RS-232 connect cable	109
Appendix C	Specifications	112
Appendix D	Quick Search Function Table	115
Appendix E	Troubleshooting	117
Appendix F	Product Service	119
Appendix G	Customer Information Card	120

Version Description

Version 2.0 built 070206:

The new version firmware DVR has the following new features:

1. Supports USB mouse

Recommended USB mouse model list:

Logitech: M-UV83

Benq: M800

ViewSonic: MC204

Philips: SPM4500BB/93

LG: LGIM-ML208

GlodFly: GF-OP718

Newmen: MS0270 (www.newmen.com.cn)

Agiler: AGM-018LU (www.agilertech.com)

Citu: CH-3090 (www.citu.cn)

2. Supports USB external DVD backup

Recommended USB external DVD model list:

LG GSA-E10L

BENQ EW164B

Samsung SE-S164

3. Supports DS-1000KI network keyboard

4. Supports E-SATA HDD backup

E-SATA interface in QSD42208, QSC26408, and QSC26416 model DVRs is optional. 1st internal SATA interface can be extended to E-SATA (external SATA) interface. In DVR “Recording” menu, you can select 1st SATA HDD as either “Recording” or “Backup” work mode.

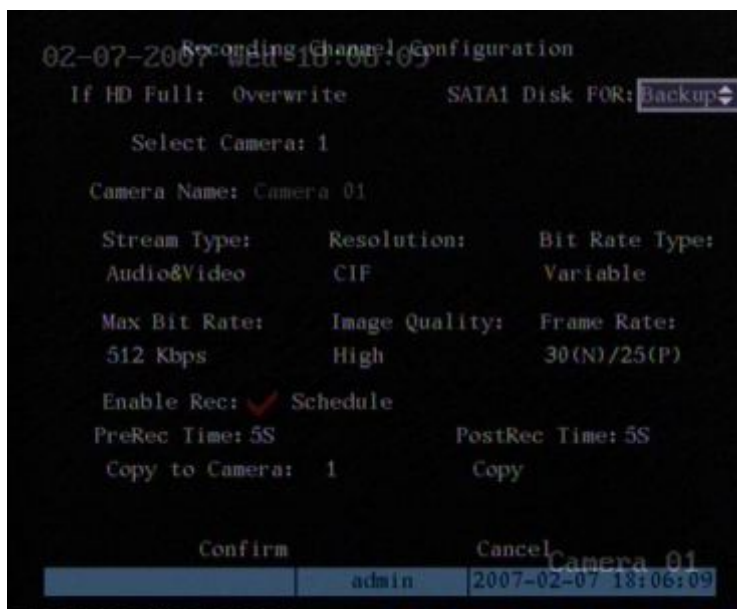
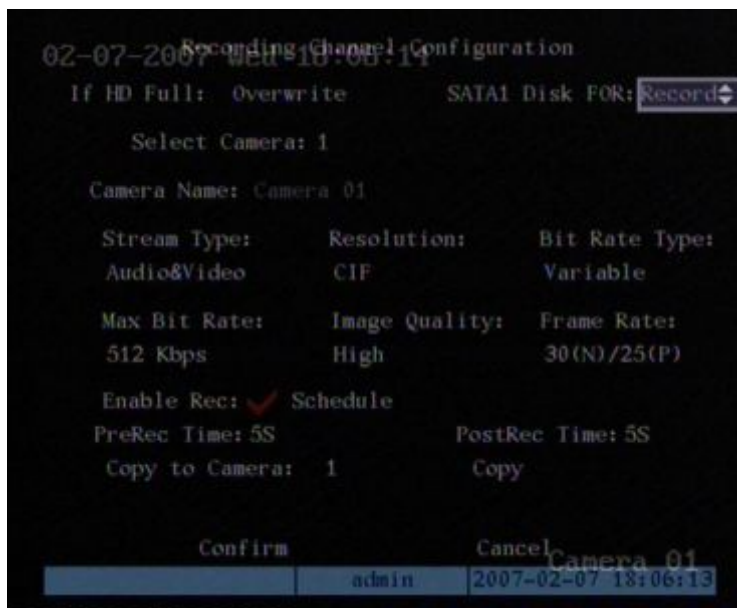

If you select “Backup” mode, in DVR “Playback” menu, you can select SATA HDD for backup.

5 . Solved some old version bugs

VGA black screen and Aux audio output issues

Chapter 1 Product Introduction

1.1 Summary

The Commercial series network digital video recorder is an excellent digital surveillance product. It uses the embedded MCU and embedded operating system (RTOS), combining the most advanced technology in the Information Industry such as video and audio encoding/decoding, hard disk recording and TCP/IP. The firmware is burned into flash memory, more stable and reliable.

The Commercial series device has both the features of digital video recorder (DVR) and digital video server (DVS). It can work stand alone, also be used to build a powerful surveillance network, widely used in banking, telecommunications, transportation, factories, warehouses, irrigation, etc.

1.2 Features

Compression

- Supports 16 channels video input (PAL/NTSC) at most. Each channel is independent, H.264 hardware compression and real time (PAL: 25 FPS, NTSC: 30FPS). Support both variable bitrate and variable frame rate.
- Supports 16 channels audio input at most. Each channel is independent, OggVorbis compression and bitrate is 16Kbps.
- Compressed video and audio are synchronous. You can select either mixed stream or only video stream.
- Supports 4CIF, DCIF, 2CIF, CIF and QCIF resolution (depending on model).
- Supports multi area motion detection.
- Supports OSD and changeable OSD position.
- Supports LOGO and changeable LOGO position.

Local functions

Record

- Supports multiple record type, including real time, manual record, motion detection, external alarm, motion&alarm, motion|alarm.
- Supports 8 SATA HDDs and each HDD can support 2000GB maximum.
- Supports FAT32 file system.
- Supports HDD S.M.A.R.T technology.
- Supports cycle or none cycle record.
- Supports backing up the recorded files and clips. Supports USB flash memory, USB HDD, USB CD-R/W, USB DVD-R/W, SATA DVDRW/CDRW HDD for backup.

Preview and playback

- Supports BNC analog monitor and VGA output for main output
- Supports one aux video and audio input
- Supports multiple preview modes.
- Supports sensitive area mask.
- Supports camera spiteful block alarm.
- Supports 2-ch synchronous playback. Support play forward, backward, pause, frame by frame, etc.
- Supports play back by files or by time.
- Displays local record status.

PTZ

- Supports many PTZ protocols.
- Supports preset, sequence and cruise.

Alarms

- Supports exception alarm, motion detection alarm, external alarm, etc.

Others

- Supports IR control.
- Supports RS-485 keyboard.
- Supports multi-level user management.

Network

- Supports TCP, UDP, RTP, Multicast for network preview.
- Supports PPPoE for broad band access.
- Supports PSTN for narrow band access.
- Supports remote parameters setup.
- Alarm information can be sent to remote center.
- Network control PTZ.
- Network record real time stream.
- Network download and playback of the recorded files in DVR.
- Remotely upgrade the firmware.
- RS-232 supports transparent channel function so that the remote PC can use DVR to control serial devices.
- Supports bi-directional voice talk or one-way voice broadcast.
- Supports IE to preview and config DVR.
- Support log.

Development support

- Provides network SDK.
- Provides client demo source code.

Chapter 2 Installation

Warning: Before you install the DVR, please make sure the power to the DVR is switched off.

2.1 Checking the DVR and Its Accessories

When you get the product, check that all the items are included in your product package. There is a list in the package. If any of the items are missing, please contact your dealer.

2.2 HDD Installation

Installation notice

The DVR has no HDD when leaving factory. Based on the record schedule, you can calculate the total capacity you need (refer to Appendix A). Please ask the specialist to disassembly the DVR and install HDD. If the vendor you purchased the DVR from did not include a HDD have HDD installed by qualified technicians.

Installation instrument

One Phillips screw driver.

HDD installation

1. Open the DVR box.
2. Take off the HDD mounting plate.
3. Place the HDD on the mounting plate and attach it with screws.
4. Attach the mounting plate in the DVR.
5. Connect the ATA data cable correctly.
6. Plug the HDD power connector into the HDD.
7. Cover and re-attach the DVR box lid.

Note: After you install the HDDs, you must format them. Please refer to section 6.4. If your vendor supplied the DVR with HDDs this may have already been done for you.

2.3 Rear Panel Description

2.3.1 8-ch QSD42208 Rear Panel

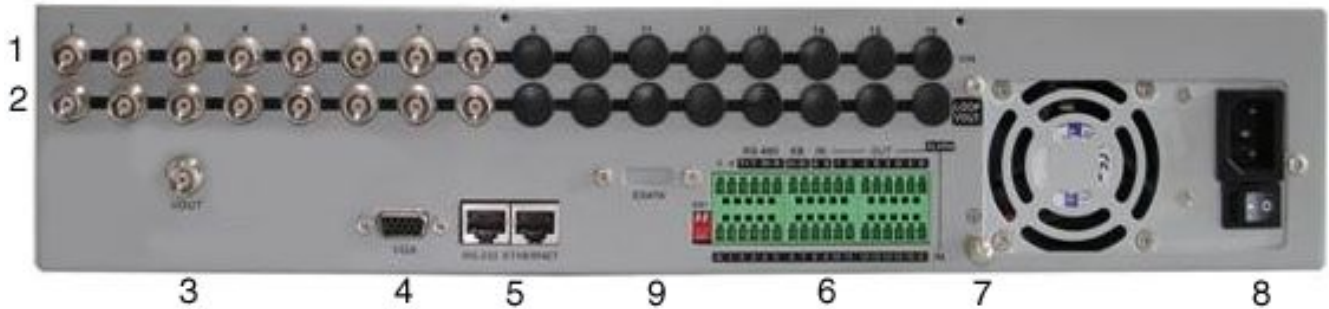

Index	Physical Interface	Description
1	Video Input	Standard BNC.
2	Loop Back Ports	Standard BNC.
3	Main video Output	Connect CCTV monitor, output video and menu.
4	VGA Interface	VGA display.
5	RS-232/Keyboard Interface	Connect RS-232 devices. Refer to Appendix B for pin definition.
	RJ45 Ethernet Port	Connect network devices. Refer to Appendix B for pin definition.
6	Keyboard Interface	Can use Hikvision DS-1000K1, DS-1002K1, DS1003K1
	RS-485	PTZ connection. Using T+/T- to connect PTZ.
	External Alarm Input	4 sensor alarm in.
	Relay Output	2 replay output.
7	GND	Ground
8	AC Input	100~240VAC
9	E-SATA	Optional. Extend 1 st internal SATA to E-SATA.

2.3.2 8-ch/16-ch QSC26408/16 Rear Panel

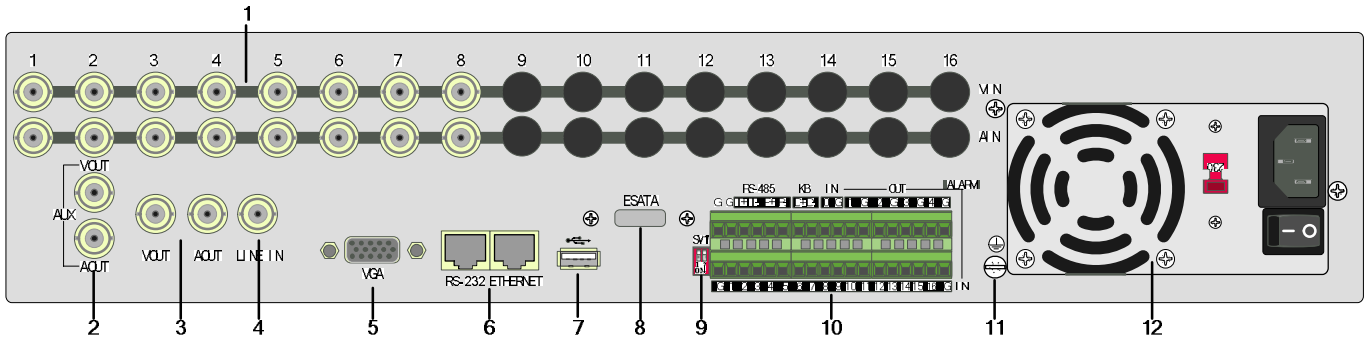

QSC26408 Rear Panel

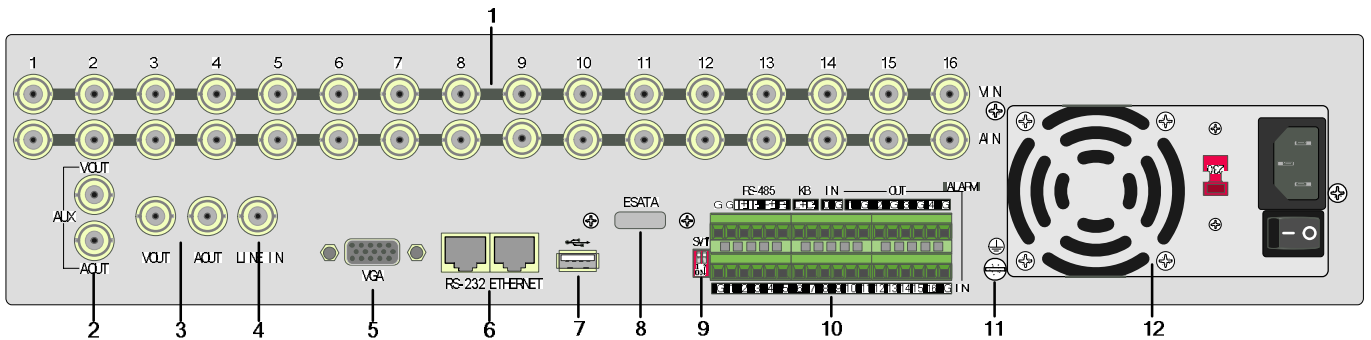

QSC26416 Rear Panel

Index	Physical Interface	Description
1	Video Input	Standard BNC.
	Audio Input	Standard BNC.
2	Aux video Output	Spot monitor for video preview and playback.
	Aux audio Output	Spot monitor for audio preview and playback.
3	Main video output	Main monitor for video and menu.
	Main audio output	Main monitor for audio preview and playback.
4	Line In	Audio line input for voice talk.
5	VGA Interface	VGA display.
6	RS-232	Connect RS-232 devices. Refer to Appendix B for pin definition.

	RJ45 Network Port	Connect network devices. Refer to Appendix B for pin definition.
7	USB Interface	USB memory disk, USB HDD, USB CD-R/W, USB DVD or USB mouse.
8	E-SATA	Optional. Extend 1 st internal SATA to E-SATA.
9	SW1	RS-485 terminal resistor switch. Default is off. The resistor is 120Ohm.
10	RS-485	PTZ connection. Using T+/T- to connect PTZ.
	Keyboard Interface	Using D+/D- for keyboard and DVR cascade connection. Can use Hikvision DS-1000K1, DS-1002K1, DS1003K1
	External Alarm Input	16 sensor alarm in.
	Relay Output	4 replay output.
11	GND	Ground
12	AC Input	100~240VAC

2.4 External Alarm In/Out Connection

Alarm input port (drp node):

G (GND): Connect the GND of sensor.

1~8: Alarm input, support normal open/normal close.

0: Reserved.

Alarm output:

1G~4G: 4 relay output.

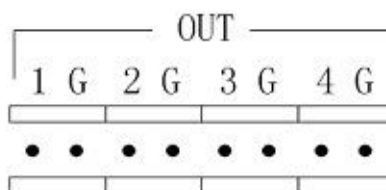
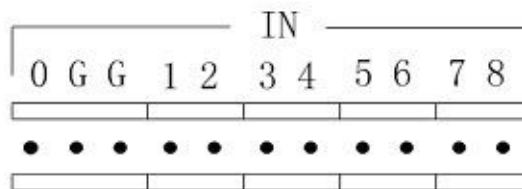

Alarm output connection

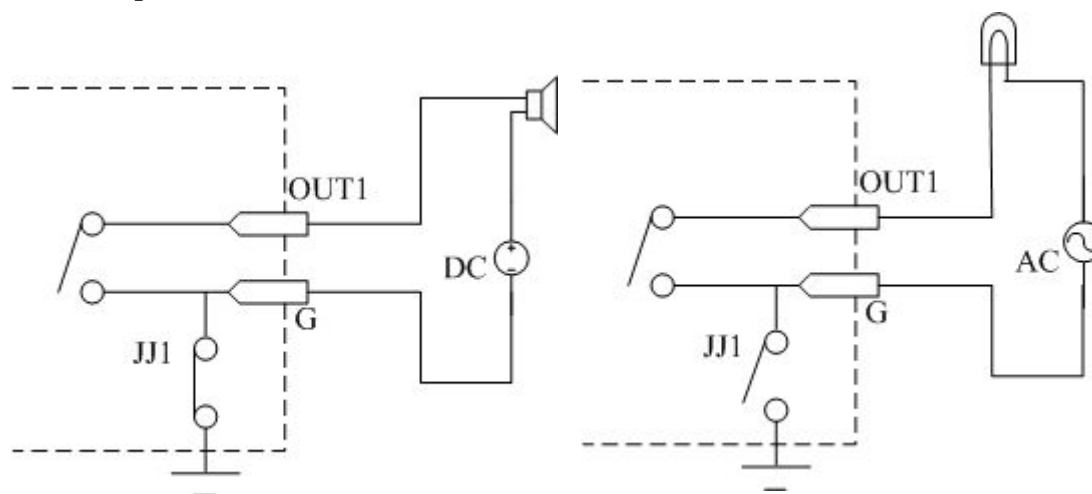

Please note the usage of jumper JJ1. If you use DC, either connection is OK. We suggest you use DC under 12V, 1A.

If you use AC, please open the jumper. There are 4 jumpers (JJ1, JJ2, JJ3 and JJ4) on DVR main board, corresponding with 4 alarm output. The default is closed.

Warning: If you use AC input for relay output, please open the jumpers.

Chapter 3 Operational Instructions

3.1.1 8-ch QSD42208 Front Panel



Index	Type	Name	Description
1	USB Port		USB flash drive, HDD, DVDRW/CDRW or Mouse
2	Status Lamps	1-8	Shows channel 1-8 status. Green means recording; Red means network transmission; Orange means recording and network transmission. Lamp twinkle and red means the corresponding HDD has error.
3	POWER	POWER	Device switch with power indicator lamp. Green means DVR is working; Red means DVR is powered off; No light means no power is supplied.
4	Compound Keys	MENU ESC PLAY REC EDIT PTZ A	<ol style="list-style-type: none"> 1. Switch preview mode into menu; 2. Brush control short key 【WIPER】 . <p>Cancel and back to parent menu.</p> <ol style="list-style-type: none"> 1. Local playback; 2. 【AUTO】 in PTZ mode. <ol style="list-style-type: none"> 1. Manual record; 2. 【SHOT】 in PTZ mode (adjust preset). <ol style="list-style-type: none"> 1. In edit state, delete current cursor character; 2. 【IRIS+】 in PTZ control; <ol style="list-style-type: none"> 1. Select ✓ or × to enable or disable. <ol style="list-style-type: none"> 1. Enter into PTZ control mode;

		PREV INFO Main/Aux	<p>2. 【IRIS-】 in PTZ control.</p> <p>1. Input switch (number, lower case, upper case and symbol);</p> <p>2. 【FOCUS+】 in PTZ control;</p> <p>3. In preview mode, display or hide the channel status bar.</p> <p>1. Multi screen preview switch;</p> <p>2. Switch menu mode into preview;</p> <p>3. 【FOCUS-】 in PTZ control.</p> <p>【ZOOM+】 in PTZ control.</p> <p>1. 【ZOOM-】 in PTZ control.</p> <p>2. Switch main/aux video output control mode.</p>
5	Input Keys	Numeric Keys F1 F2	<p>Input number, lower case, upper case character and symbols.</p> <p>【LIGHT】 in PTZ control.</p> <p>【AUX】 in PTZ control.</p>
6	Control Keys	Direction Keys ENTER	<p>Composed of 【↑】 , 【↓】 , 【←】 and 【→】 .</p> <p>1. Menu mode, use 【←】 / 【→】 to select 【↑】 / 【↓】 to edit;</p> <p>2. PTZ direction control;</p> <p>3. Playback speed control.</p> <p>1. Menu confirmation;</p> <p>2. Select ✓ or × to enable or disable;</p> <p>3. Pause playback.</p>

3.1.2 8-ch QSC26408 Front Panel

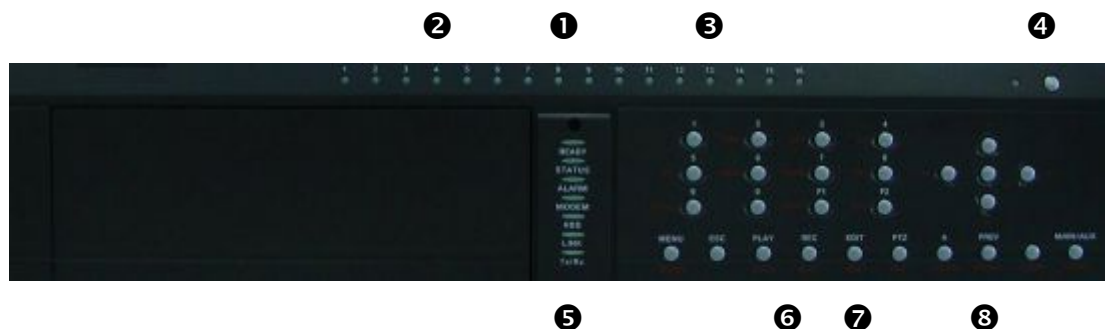

Index	Type	Name	Description
1			IR receiver.
2	Status Lamps	1-8	Shows channel 1-8 status. Green means recording; Red means network transmission; Orange means recording and network transmission. Lamp twinkle and red means the corresponding HDD has error.
3	Status Lamps	9-16 (Previous model QSC26416)	Shows channel 1-16 status. Green means recording; Red means network transmission; Orange means recording and network transmission.
4	POWER	POWER	Device switch with power indicator lamp. Green means DVR is working; Red means DVR is powered off; No light means no power is supplied.
5	Status Lamps	READY STATUS ALARM MODEM HDD LINK Tx/Rx	DVR is ready. Green means you can use IR remote control. Red means there is an alarm. Green means modem connection and dial-up successful. Twinkle in red means reading or writing HDD. Green means network is OK. Twinkle in green means data is being transmitted.
6	Command Keys	MENU ESC PLAY	1. Switch preview mode into menu; 2. Brush control short key 【WIPER】 . Cancel and back to parent menu.

		<p>REC</p> <p>EDIT</p> <p>PTZ</p> <p>A</p> <p>PREV</p> <p>INFO</p> <p>Main/Aux</p>	<p>1. Local playback 2. 【AUTO】 in PTZ mode.</p> <p>1. Manual record;</p> <p>2. 【SHOT】 in PTZ mode (adjust preset).</p> <p>1. In edit state, delete current cursor character;</p> <p>2. 【IRIS+】 in PTZ control;</p> <p>2. Select ✓ or × to enable or disable.</p> <p>1. Enter into PTZ control mode;</p> <p>2. 【IRIS-】 in PTZ control.</p> <p>1. Input switch (number, lower case, upper case and symbol);</p> <p>2. 【FOCUS+】 in PTZ control;</p> <p>3. In preview mode, display or hide the channel status bar.</p> <p>1. Multi screen preview switch;</p> <p>2. Switch menu mode into preview;</p> <p>3. 【FOCUS-】 in PTZ control.</p> <p>【ZOOM+】 in PTZ control.</p> <p>3. 【ZOOM-】 in PTZ control.</p> <p>4. Switch main/aux video output control mode</p>
7	Input Keys	Numeric Keys F1 F2	<p>Input number, lower case, upper case character and symbols.</p> <p>【LIGHT】 in PTZ control. 【AUX】 in PTZ control.</p>
	Control Keys	Direction Keys ENTER	<p>Composed of 【↑】 , 【↓】 , 【←】 and 【→】 .</p> <p>1. Menu mode, use 【←】 / 【→】 to select 【↑】 / 【↓】 to edit;</p> <p>2. PTZ direction control;</p> <p>3. Playback speed control.</p> <p>1. Menu confirmation;</p> <p>2. Select ✓ or × to enable or disable;</p> <p>3. Pause playback.</p>

3.1.3 16-ch QSC26416 Front Panel

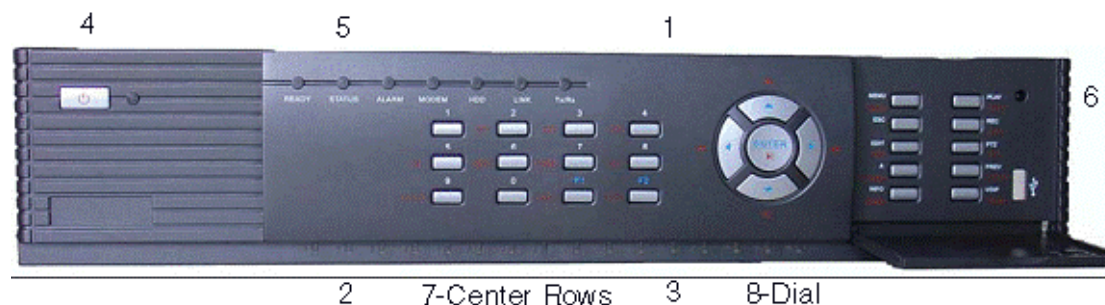

Index	Type	Name	Description
1			IR receiver.
2	Status Lamps	1-8	Shows channel 1-8 status. Green means recording; Red means network transmission; Orange means recording and network transmission. Lamp twinkle and red means the corresponding HDD has error.
3	Status Lamps	9-16	Shows channel 1-16 status. Green means recording; Red means network transmission; Orange means recording and network transmission.
4	POWER	POWER	Device switch with power indicator lamp. Green means DVR is working; Red means DVR is powered off; No light means no power is supplied.
5	Status Lamps	READY STATUS ALARM MODEM HDD LINK Tx/Rx	DVR is ready. Green means you can use IR remote control. Red means there is an alarm. Green means modem connection and dial-up successful. Twinkle in red means reading or writing HDD. Green means network is OK. Twinkle in green means data is being transmitted.
6	Command Keys	MENU ESC PLAY REC	1. Switch preview mode into menu; 2. Brush control short key 【WIPER】 . Cancel and back to parent menu. 1. Local playback; 2. 【AUTO】 in PTZ mode.

		<p>EDIT</p> <p>PTZ</p> <p>A</p> <p>PREV</p> <p>INFO Main/Aux</p>	<p>1. Manual record;</p> <p>2. 【SHOT】 in PTZ mode (adjust preset).</p> <p>1. In edit state, delete current cursor character;</p> <p>2. 【IRIS+】 in PTZ control;</p> <p>3. Select ✓ or × to enable or disable.</p> <p>1. Enter into PTZ control mode;</p> <p>2. 【IRIS-】 in PTZ control.</p> <p>1. Input switch (number, lower case, upper case and symbol);</p> <p>2. 【FOCUS+】 in PTZ control;</p> <p>3. In preview mode, display or hide the channel status bar.</p> <p>1. Multi screen preview switch;</p> <p>2. Switch menu mode into preview;</p> <p>3. 【FOCUS-】 in PTZ control.</p> <p>【ZOOM+】 in PTZ control.</p> <p>5. 【ZOOM-】 in PTZ control.</p> <p>6. Switch main/aux video output control mode.</p>
7	Input Keys	Numeric Keys F1 F2	<p>Input number, lower case, upper case character and symbols.</p> <p>【LIGHT】 in PTZ control.</p> <p>【AUX】 in PTZ control.</p>
8	Control Keys	Direction Keys ENTER	<p>Composed of 【↑】 , 【↓】 , 【←】 and 【→】 .</p> <p>1. Menu mode, use 【←】 / 【→】 to select 【↑】 / 【↓】 to edit;</p> <p>2. PTZ direction control;</p> <p>3. Playback speed control.</p> <p>1. Menu confirmation; 2. Select ✓ or × to enable or disable;</p> <p>3. Pause playback.</p>

3.2 Remote Control



Index	Name	Description
1	POWER	Turnoff device.
2	DEV	Enable/Disable IR remote control
3	Numeric Keys	Same as numeric keys of front panel.
4	EDIT	Same as EDIT key of front panel.
5	A	Same as A key of front panel.
6	REC	Same as REC key of front panel.
7	PLAY	Same as PLAY key of front panel.
8	INFO	Same as INFO key of front panel.
9	VOIP	Same as [Main/Aux] key of front panel.
10	MENU	Same as MENU key of front panel.
11	PREV	Same as PREV key of front panel.
12	Direction Keys ENTER	Same as direction keys and enter key of front panel.

13	PTZ	Same PTZ key of front panel.
14	ESC	Same as ESC key of front panel.
15	Reserved	
16	F1	Same as 【F1】 key of front panel.
17	Lens control	IRIS, FOCUS ZOOM for lens control of PTZ camera.
18	F2	Same as 【F2】 key of front panel.

Loading the batteries into the Remote Control

1. Remove the battery cover.
2. Insert the battery. Please make sure the poles (+ and -) are correctly positioned.
3. Replace the battery cover.

Start to use the Remote Control

Press **【DEV】** key, input the DVR device ID (default is “88”, can be changed in “Display” menu) and then press **【ENTER】** key. If the “STATUS” lamp of DVR front panel turns to green, it means you can use IR controller to operate this DVR.

Stop using the Remote Control

When remote control status is on, press **【DEV】** key again, the “STATUS” lamp will be turned off, then the remote control can not control this DVR.

Switch the DVR off

When remote control status is on, press **【POWER】** key for several seconds, the DVR will be powered off.

When the Remote Control can not work normally

- Check batteries pole positions.
- Check the remaining charge in the batteries.
- Check to see the remote control sensor is covered.

If the problem is still exists, please contact administrator.

3.3 Menu Description

3.3.1 Menu Items

Menu Name	Function	Menu Name	Function
Display	Video standard Brightness Menu transparency Unit name Device ID Require password Screen saver time VGA resolution Date and Time	Image	Camera name and position setup Adjust Brightness, Contrast, Hue and Saturation OSD Display mode, position and OSD format setup Mask area setup View tampering area and response setup Video signal loss Motion detection sensitivity, area and response setup
Recording	Overwrite/Stop recording Resolution and recording parameters setup Record schedule PreRecord time PostRecord time	Network	DVR IP address DNS IP Multicast IP address Remote host IP and port NAS IP and directory PPPoE username and password
Alarms	Alarm input type (Normal open/Normal close) Alarm response and PTZ linkage Alarm output and schedule	Exceptions	Exceptions type Exceptions response
PTZ	PTZ parameters Preset setup Sequence setup Cruise setup	RS232	RS232 parameters RS232 work mode
Preview	Preview mode Switch time Enable/Disable audio preview Preview layout	User Password	Add or delete user Password setup or modification User rights setup

<p>Transaction</p>	<p>Text input mode ATM IP address ATM type Text information</p>	<p>Utilities</p>	<p>Restore parameters Upgrade firmware HDD management Clear alarm output Reboot Power off View log System information</p>
---------------------------	---	-------------------------	---

3.3.2 Menu Operation

How to enter into menu mode

- Press **【MENU】** key to enter into DVR main menu.
- Press **【PLAY】** short key to enter into playback menu.
- Press **【REC】** short key to enter into manual record menu.
- Press **【PTZ】** short key to enter into PTZ control interface.

Notes: You must input user name and password. The default user name is “admin” and password is “12345”.

Main Menu Description

The main menu interface is:

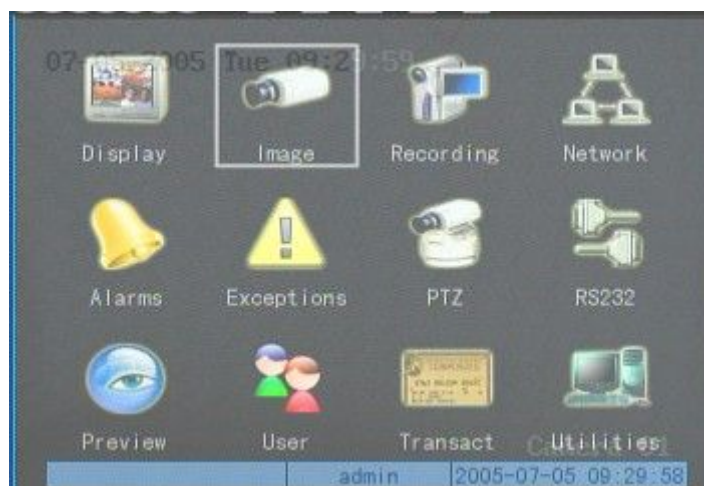

There is one rectangular frame called “Active Frame”. It can be moved from one icon to another by using **【→】** or **【←】** key. When the “Active Frame” is located on an icon, you can press

【ENTER】 key to enter into the secondary menu. For example, move the “Active Frame” to the “Image” icon, press **【ENTER】** to enter into the secondary menu show below:

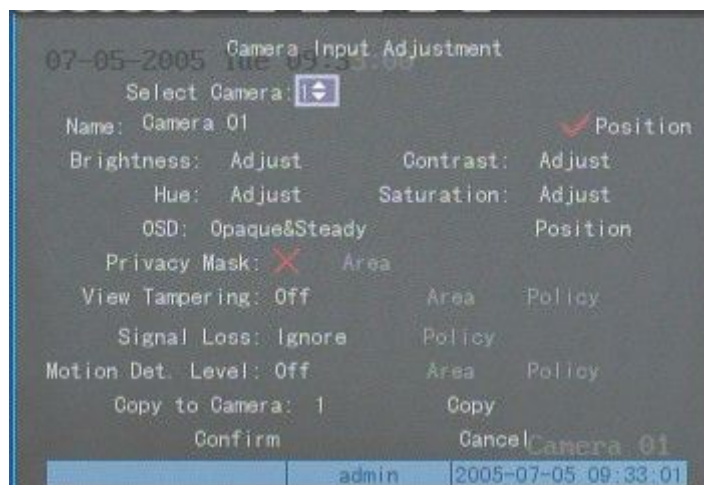

Each menu contains different kinds of items. There is a rectangular frame called “Active Frame” which is pointing to the selected item. This “Active Frame” can be moved by **【→】** or **【←】** keys. There are such kinds of menu items:

- a) Check Box: Provide 2 options, “✓” means enable and “x” means disable. You can use **【ENTER】** or **【EDIT】** key to switch over.
- b) List Box: Provides more than 2 options. However, only one of them can be selected. You can use **【↑】** and **【↓】** to select one option. For example, on the right side of “Select Camera”, there is a list box for you to select one camera.
- c) Edit Box: This is for you to input characters. Press **【EDIT】** key to enter into edit status, you can input characters as follows:
 - i. Press **【A】** key to select number, upper case, lower case or symbols;
 - ii. Use **【→】** and **【←】** keys to move cursor;
 - iii. Use **【EDIT】** key to delete the character in front of cursor;
 - iv. Press **【ENTER】** or **【ESC】** to exit edit.
- d) Button: Execute a special function or enter into next sub-menu. For example, press “Policy” button to enter into sub-menu. Press **【Confirm】** to save parameters and return

to parent menu. Press **【Cancel】** button to cancel and return to parent menu. The button in grey means it can be operated only after it is enabled.

How to exit menu

Press **【PREV】** key to exit menu and return to preview mode.

3.4 Character Input

In the menu interface, if you enter into edit status (for example, in the “camera name” edit box), at the bottom of screen, the input status appears:

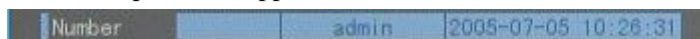

Here you can press numeric keys to input digital numbers.

Press **[A]** key to change input methods. You can select “number”, “Uppercase”, “Lowercase” or “Symbol”.



There are 24 symbols in all. They are divided into 4 pages, and you can use **[0]** key to go to the next page.

Chapter 4 Basic Operation Guide

4.1 Power on

Note: Please make sure the power supply matches DVR and AC cable is connected correctly. Before switching DVR on, please connect one monitor with VOUT or VGA interface. Otherwise, you can not see graphic user interface and can not operate.

If **【POWER】** lamp is off, please check the following:

Step1: Connect AC cable correctly;

Step2: Switch on the power button on the rear panel.

If **【POWER】** lamp is in red, just press **【POWER】** button to start DVR.

When DVR is started, **【POWER】** lamp is green. On the monitor or VGA display, DSP and HDD initialization process will be shown.

The first line represents DSP initialization. If the DSP icon is “×”, it means that the DSP has an initialization error, please contact administrator at once.

The second line represents HDD initialization. Icons of SATA hard drives are displayed. If the HDD icon has a “×”, it means the corresponding HDD is not installed or not detected. If the HDD is installed but not detected, please contact administrator.

Note: If HDD is not installed or not detected, DVR will beep for alarm. You can disable the alarm option in “Exceptions” menu.

4.2 Preview

DVR will enter into preview mode after it is started.

On preview screen, you can see date, time, camera name and camera status icon.

Set system date and time in “Display” menu, refer to section 5.2.9; Change camera name in “Image” menu, refer to section 5.3.2.

In the screen, it will display record and alarm status of each camera. These two kinds of status will switch over automatically.

Press **[A]** key to display or hide the camera status bar.







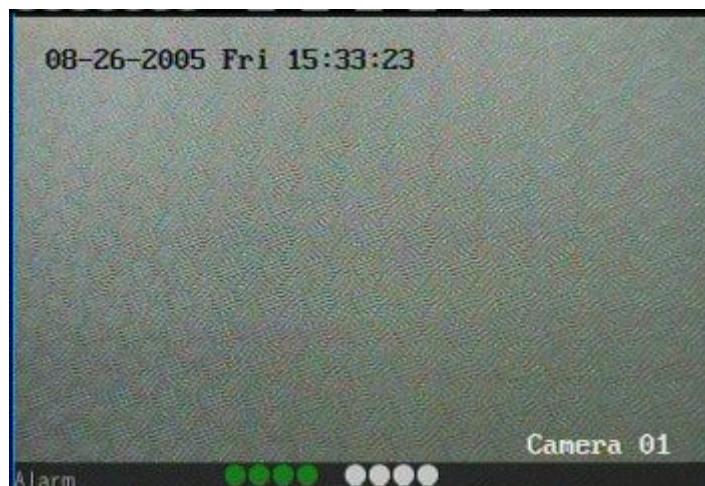

Camera record status is:

Icon	Icon Color	Status Description
	White	No video signal
	Yellow	Vdideo input
	Pink	Manual recording
	Green	Real time recording
	Blue	Motion detect recording
	Red	External alarm recording



Camera alarm status is:

Icon	Icon Color	Status Description
	White	Video signal lost
	Yellow	View tampering alarm
	Pink	Motion&External alarm
	Green	No alarm
	Blue	Motion alarm
	Red	External alarm

Press numeric keys to switch to individual camera preview. If DVR has less than 10 channels, press one numeric key to switch corresponding channel. For example, press **【2】** key to preview 2nd camera. **If DVR has 10 or more than 10 channels, press two numeric keys to switch to corresponding channel. For example, press **【0】【2】** to preview 2nd camera; and press **【1】【2】** keys to preview 12th camera.**

Press **【EDIT】** key to manually cycle preview. **You can set the auto preview mode in “Preview” menu, refer to section 5.11.**

Press **【PREV】** key to switch multi-screen preview.

4.3 User name and password

Note: When DVR is delivered from factory, there is only one default administrator named “admin”, and password is “12345”. The administrator’s name can not be modified, while the password can be modified. The administrator can create 15 users and define their user rights.

Login

Login dialog box:

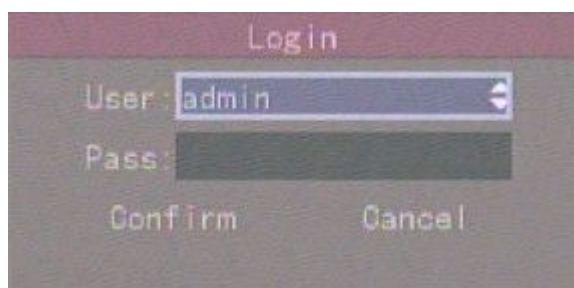

Use **【↑】**/**【↓】** keys to select one user, press **【→】** key to enter into “Password” edit box, input corresponding password, press **【ENTER】** key to exit edit box. The “Active Frame” will be moved to “Confirm” button. Press **【ENTER】** key to enter into main menu. If there is beeper alarm, it means the user name and password do not match. After three incorrect tries the DVR will enter into preview mode.

Modify password

For those users created by admin, they can modify their password as follows:

Step1: Enter into main menu

Press **【MENU】** key, in the login dialog, select your user name, input the correct password, you can enter into the main menu.

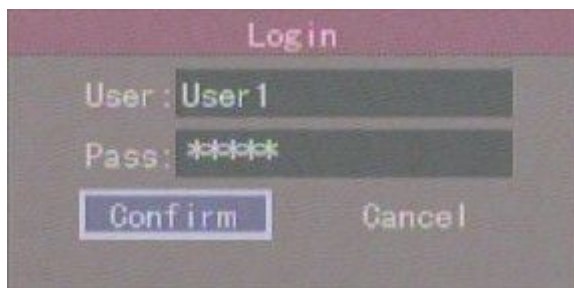



Step 2: Enter into password modification menu

Move the “Active Frame” to “Password” icon by using **[→]** / **[←]** keys. Press **[ENTER]**

key to enter into password menu:



Step 3: Input new password

Press **[EDIT]** key to enter into edit box. You can use numeric keys to input new password.

The password can be null. It also can be 16 numerals. Press **[ENTER]** to exit edit box, and move to “Verify” item to input the new password for verification.

Note: In edit box, use **[→] / **[←]** to move cursor and **[EDIT]** key to delete the numeral in front of the cursor.**

Step 4: Modify password successfully

Move the “Active Frame” to “Confirm” button, press **[ENTER]** key. If the password is

modified successfully, you will get the main menu or an error dialog box will pop up. You can repeat step 3 to modify again.

4.4 PTZ Control

Note: The user must have the “PTZ control” right.

PTZ control interface

In preview mode, press **【PTZ】** key, in the login dialog, select one user name and input the correct password, you can enter into PTZ control interface.

In menu mode, press **【PTZ】** key, you can enter into PTZ control interface directly.

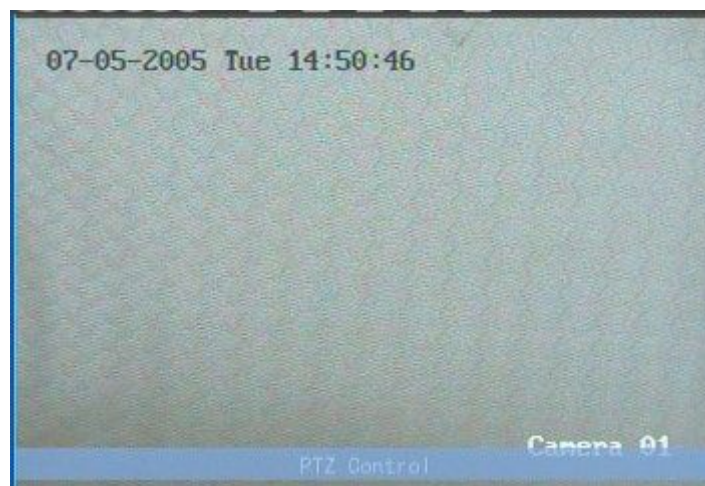

There is “PTZ Control” prompt in the PTZ control interface. The displayed camera name shows which channel’s PTZ is under control. For example, “Camera 01” means you are controlling the 1st camera PTZ.

Select channel

In PTZ control mode, you can press numeric keys to select channel. If DVR has less than 10 channels, press one numeric key to select. For example, press **【2】** key to select 2nd camera PTZ. **If DVR has 10 or more than 10 channels, you must press two numeric keys to select. For example, press 【0】【2】 to select 2nd camera PTZ, and press 【1】【2】 to select 12th camera PTZ.**

After you select the camera PTZ, you can use the directional keys on the front panel or the remote to control PTZ.

PTZ control keys description

Direction control keys: **【↑】** , **【↓】** , **【←】** , **【→】** ;

ZOOM control keys: **【ZOOM+】** , **【ZOOM-】** ;

FOCUS control keys: **【FOCUS+】** , **【FOCUS-】** ;

IRIS control keys: **【IRIS+】** , **【IRIS-】** ;

Adjust preset keys: **【REC/SHOT】** ;

Auto control key: **【PLAY/AUTO】** ;

Wiper control key: **【WIPER/MENU】** ;

Light control key: **【LIGHT/F1】** ;

Auxiliary device control key: **【AUX/F2】**

Adjust preset description

In PTZ control mode, press **【REC/SHOT】** key, and press the preset number (three numeric keys), DVR will adjust the corresponding preset number. Repeat pressing **【REC/SHOT】** key, and press the preset number, DVR will adjust that preset number.

When you exit PTZ control mode, the camera will stay at the current position.

Note: The PTZ preset number is set already. Please refer to PTZ menu for preset setup. Current firmware can support 128 preset number at most.

Start/Stop auto in PTZ control mode

In PTZ control mode, press **【PLAY/AUTO】** key to start PTZ auto function. Press **【PLAY/AUTO】** key again to stop.

When PTZ is in auto mode, if you exit PTZ control mode, PTZ will continue auto function. You must enter into PTZ control mode again, and press **【PLAY/AUTO】** key to stop.

Exit PTZ control mode

Press **【ESC】** or **【ENTER】** to exit and return to preview mode.

4.5 Manual Record

Note: The user must have the corresponding right, DVR must have HDD and HDD must be formatted.

Manual record

In preview mode, press **【REC】** key, in the pop-up login dialog, select the name and input the correct password, you can then enter into the “Manual Record” interface.

In menu mode, press **【REC】** key to enter into “Manual Record” interface directly.



Description

Manual record interface has following parts: channel number, channel status, start/stop record, start all and stop all buttons.

Channel: Lists the channel numbers that the DVR has.

Status: Channel work status has 4 cases:  means idle. Green means the channel is recording (including real time recording, alarm recording, motion detection recording). Red means network transmission. Orange means both recording and network transmission.

Start/Stop: “✓” means you can start corresponding channel recording. “x” means you can stop recording.

Start All: Press this button to start all channels recording.

Stop All: Press this button to stop all channels recording.

Exit manual record

Press **【ESC】** key to enter into preview mode. Press **【MENU】** key to enter into main menu.

Press **【PLAY】** key to enter into playback menu. Press **【PTZ】** key to enter into PTZ control mode.

4.6 Playback

Note: The user must have “Playback” right.

Playback interface

In preview mode, press **【PLAY】** key, in the pop-up login dialog, select username and input correct password, you can enter into “Playback” interface.

In menu mode, press **【PLAY】** key, you can enter into “Playback” interface directly.



One Channel Playback



Two Channel Playback

Description

If DVR only supports one channel playback, you can not select second channel. If DVR can support two channel playback, you can select second channel.

Main Channel: Use **【↑】** or **【↓】** key to select one channel.

Second: If DVR supports 2-ch playback, you can use **【↑】** or **【↓】** key to select the second channel.

These two channels can be played back simultaneously. If you select the second channel as none, only the main channel is played back.

Rec Type: Use **【↑】** or **【↓】** to select recorded files type. The file type options have “All”, “All Time”, “Motion Detect”, “Alarm” and “Manual”.

Time Section: You can define the search time section. Move “Active Frame” to the time edit box, use numeric keys to input the detail time.

Card Number: DVR can get text number through RS-232 or network port. The text is sent from devices such as ATM machine, POS machine or others. DVR can overlay the text on the real time image and record. You can use the text to search the recorded files and play them back. Use the numeric keys to input the text number.

Search: Search the matched recorded files and display them in the list box. If there is no matched file, a corresponding dialog box will be pop-up.

Play by Time: Playback the recorded stream directly based on the time section.

Select Page: In the file list box, each page will only display 8 files. If the matched files are more than 8, you can select page to list other files. 500 pages (4000 files) can be searched at one time. You can use numeric keys or **【↑】** **【↓】** keys to select page.

File List Box: Lists the matched files. File started time, file size are displayed in the list box. You can use **【↑】** **【↓】** keys to move the scroll bar to select file.

Backup Devices: You can select USB flash, USB HDD, USB DVDRW/CDRW, SATA DVDRW/CDRW or SATA HDD to backup the files or clips.

Copy: Start to backup.

Backup Today: Backup all recorded files from today.

Three kinds of playback mode

1. Search and playback file: In the playback interface, you can select main channel, second channel (2-ch playback), record type, time section. Move “Active Frame” to “Search” button and press **【ENTER】** key, DVR will search and list the matched files.

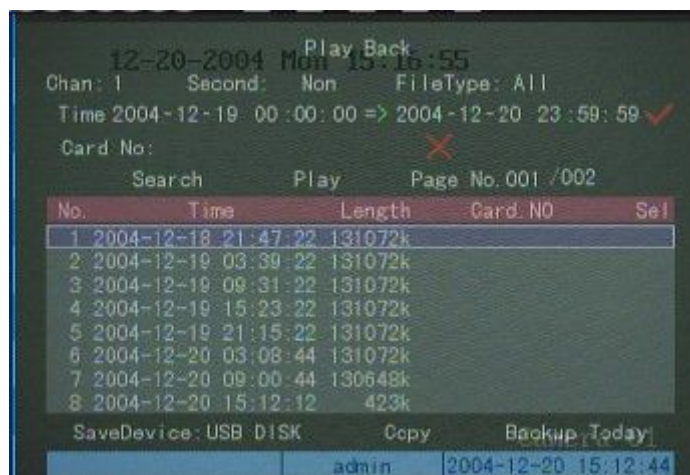

If the matched files are more than 8, you can use “Page No.” to select page (use numeric keys or **【↑】【↓】** keys to select page). In the file list box, use **【↑】【↓】** keys to move the scroll bar to the file, press **【ENTER】** key to playback the file. If the second channel is selected, these two channels can be played back simultaneously

If DVR can not find the matched files, a failure dialog box will pop-up.

2. Playback by Time: In the playback interface, select main channel, second channel (2-ch playback), record type and time section, move “Active Frame” to “Play” button, press **【ENTER】** key, DVR will start to playback based on time section.

3. Search by Card No and Playback file: In the playback interface, select main channel, second channel (2-ch playback), record type, enable card No. search option (“✓”) and input the card number, move “Active Frame” to “Search” button, press **【ENTER】** key, DVR will search and list the matched files. If the matched files are more than 8, you can use numeric keys or **【↑】【↓】** keys to select page. Use **【↑】【↓】** keys to move scroll bar to the file, press **【ENTER】** key to playback the selected file. If DVR can not find any matched files, a message dialog box will pop-up.

Operation when playing back

Playback picture:



One Channel Playback



Two Channel Playback

At the bottom of the image, there is an information bar with the following information: Volume, Play Progress, Play Speed, Played Time and File Total Time.

- Display/Hide information bar: **【MENU】**
- Open/Close sound: **【PLAY】**
- Adjust play progress: **【←】** (Backward), **【→】** (Forward). The unit is “%”.
- Adjust play speed: Normal speed is “1x”. Use **【↑】** to increase play speed (2X, 4X,

8X and MAX). Use **【↓】** to decrease play speed (1/2X, 1/4X, 1/8X and Frame by Frame)

- Pause/Continue: Press **【ENTER】** to pause/continue playback. If played frame by frame, Press **【ENTER】** to display one frame.
- Copy segment: **【EDIT】**
- Exit: **【ESC】**
- Playback switch: When in 2-ch playback, press **【PREV】** to switch between main channel and second channel.

Note: When DVR is busy, if you select high play speed, there may be a difference from actual play speed.

Exit playback

In playback interface, press **【ESC】** key to enter into preview mode.

In playback interface, press **【MENU】** key to enter into main menu, press **【REC】** key to enter into manual record, and press **【PTZ】** key to enter into PTZ control mode.

4.7 Backup Recorded Files

Note: The user must have “Playback” right. Please connect with backup devices before you start to backup.

In the playback interface, you can backup the recorded files.

In the preview mode, press **【PLAY】** key, in the login dialog box, select username and input the correct password, you can enter into the playback interface.

In the menu mode, just press **【PLAY】** key, you can enter into playback interface directly.

Record Daily Backup

In the playback interface, move “Active Frame” to “Backup Today” button, press **【ENTER】** key, all recorded files of all channels for the day will be backed up to the save device. A pop-up dialog box will display the backup status.

If backup device is not connected correctly or DVR does not detect the backup device, the following dialog box will pop-up. Please ask administrator for more information.



Backup the files that you selected

Step 1: Search the matched files

In the playback interface, select one channel and record type, input the time section, move “Active Frame” to “Search” button, press **【ENTER】** key, DVR will start to find and list the matched files.

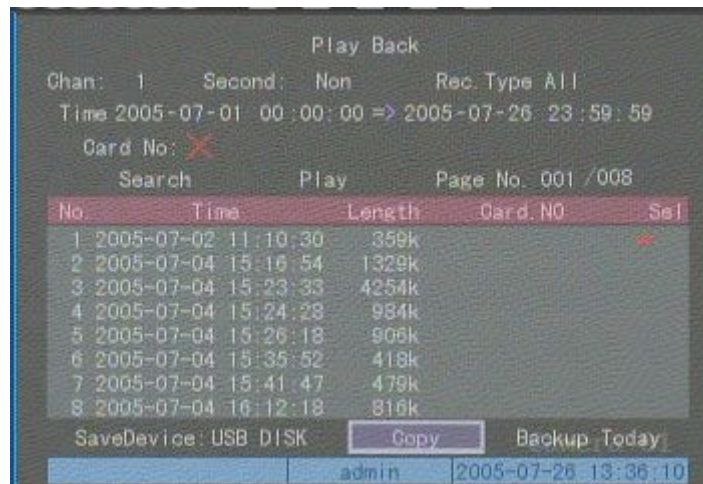

Step 2: Select the files that you want to backup

In the file list box, use **【↑】** or **【↓】** keys to move the scroll bar. When the scroll bar stays at the file you want to backup, press **【EDIT】** key to select it. The symbol “✓” is the selection tag. You can use the same method to select other files you want to backup. After finishing, you can do the next step.

Step 3: Select backup device

Please select the backup device: USB flash memory, USB HDD, USB DVDRW/CDRW, SATA DVDRW/CDRW, or SATA HDD.

Step 4: Start and finish backup

Move “Active Frame” to “Save” button and press **【ENTER】** key to start backup.

When backup is started, corresponding message box will pop-up to indicate the result.

Backup video segment

You also can backup the image segments when the image is being playback. The steps are:

- 1) Enter into the interface of playback the files or playback by time;
- 2) Press **【EDIT】** key to start selecting the current playback images, and press **【EDIT】** again to stop selecting. This segment is selected;
- 3) You can repeat step 2 to select many segments. 30 segments can be selected in all;
- 4) After you select all segments, press **【ESC】** key, a message window will pop-up. If you press “Confirm” button, DVR will start to backup the selected segments. If you press “Cancel” button, DVR will abort backup.

Note: The backup function is effective when two channels are played back simultaneously. In such case, each channel can backup 30 segments so 60 segments can be backed up for two channels.

Playback the video segment

You can use our file player software to playback the video segment in PC. You can find the player software on the included CD.

Exit playback interface

Please refer to chapter 4.6.

4.8 Shut Down DVR

Note: Do not switch off the power directly in case of damaging HDD. The correct step is using “Power Off” in the “Utilities” menu, or 【POWER】 key on the front panel or on IR controller.

Shut down DVR normally

Use menu

Enter into “Utilities” menu, move “Active Frame” to “Power Off” button and enter into power off dialog box, press “Confirm” to shut down the DVR.

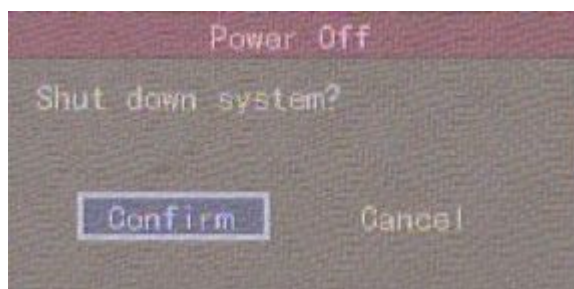

Use 【POWER】 key of front panel or IR controller

Press 【POWER】 key for 3 seconds.

In preview mode, a login dialog box will pop-up, select user name and input password, press 【Enter】 to enter into power off dialog box and press “Confirm” to shut down DVR. If you input incorrect password three times, DVR will return preview mode.

In menu mode, if the user has “Utilities” right, you can enter into power off dialog box, press

“Confirm” to shut down DVR. Otherwise, the user can not shut down DVR.

If DVR is shut down correctly, the **【POWER】** lamp is on red.

Note: When message of “Shut down...” has appeared, please do not press **【POWER】** key any more, otherwise, DVR can not be shut down.

Abnormally Shutting down DVR

Using the power switch on rear panel

When DVR is running, if you switch off the power, the HDD in DVR may be damaged. Please avoid such operation.

Taking away the power cable

Please avoid taking away the power cable directly.

Note: In some cases, when the power supply is abnormal, DVR will be damaged. We suggest that you use recommended power supplies.

Chapter 5 Main and Aux Output Function

5.1 Main and aux output

QSC26408, and QSC26416 Commercial series DVRs have one main output and one aux output.

You can use main video output to enter into DVR menu as follows, while aux output can not display DVR menu.



The aux output can support DVR local preview, local playback and local PTZ control. Press **【Main/Aux】** button to switch between “Main” output and “Aux” output control mode.

5.2 Main and Aux output preview

You can use “Main” output to enter into DVR menu, setup both “Main” and “Aux” output preview properties.

Please press **【Main/Aux】** button to enter into “Main” output control mode, then press **【Menu】** button to enter into DVR menu, the main video output will display the following DVR menu:



Move “Active Frame” to “Preview” icon and press **【ENTER】** to enter into “Preview” menu:

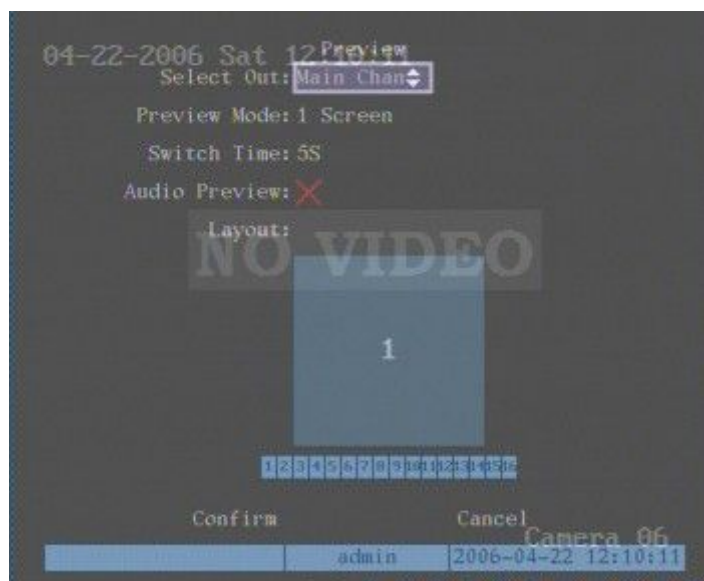

You can select out to setup main output and aux output respectively.

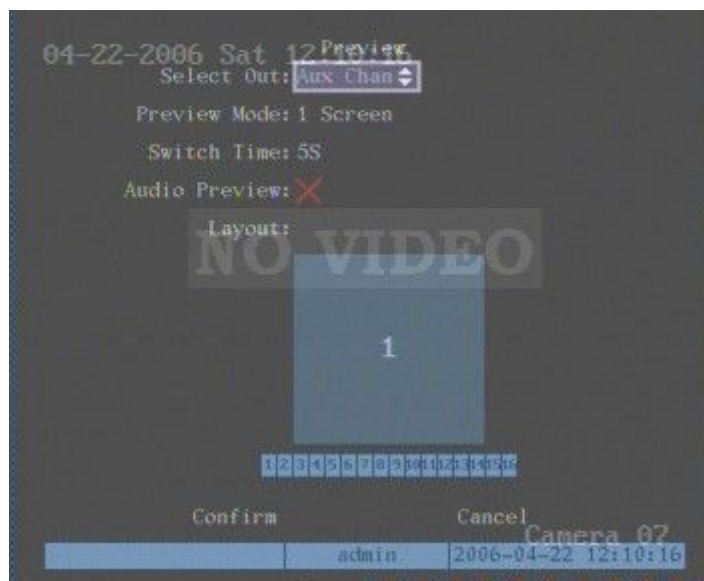

Preview mode: For preview mode item, you can use **【↑】【↓】** key to select one mode. If DVR has only 1 channel, you can select only “1 Screen” option. If DVR has 4 channels, there are “1 Screen” and “4 Screen” options. If DVR has more than 4 but less than 9 channels, there are “1 Screen”, “4 Screen” and “9 Screen” options. If DVR has 16 channels, there are “1 Screen”, “4 Screen”, “9 Screen”, “12 Screen” and “16 Screen” options.

Switch time: That is image preview switch time. You can use **【↑】【↓】** keys to select switch time. There are many options, including “5 Seconds”, “10 Seconds”, “20 Seconds”, “30 Seconds”, “60 seconds”, “120 seconds”, “600 seconds” and “Never”. If you select “Never”, the preview image will not be switched automatically. For example, for 16 channels DVR, if you select “4 Screen” preview mode and “20 Seconds” switch time, DVR will cycle display 4 channel image every 20 seconds.

Audio preview: If you enable audio preview (“✓”), when you preview single camera, DVR will play the audio of that channel.

Preview layout setup: There is a square frame divided into many windows. If you select “4 Screen” preview mode, this frame is divided into 4 windows. Each window represents one camera. You can move “Active Frame” among the windows. There is one bar under the square to display the preview order of all cameras.

First select the biggest screen preview mode, for example, for 16-channel DVR, select “16 Screen” preview mode so that all windows are display in the square.

Secondly, move “Active Frame” to one of these windows, press numeric keys to input camera index (If DVR has less than 10 channels, just use one numeric key, otherwise, use 2 numeric keys). The small window will display that camera number. In this way you can change the display order. If you press 0 or 00, then the corresponding window will not display live video.



After you define the camera preview order, you can select preview mode to meet your demand.

Save setup: Press “Confirm” button to save preview configuration. Press “Cancel” or **【ESC】** key to abort.

Whether in “Main” or “Aux” output control mode, you can press **【PREV】** button to enter into live preview and change preview screen mode.

5.3 Main and Aux output playback

Both “Main” and “Aux” output can be used to playback the recorded files on DVR HDD. Press **【Main/Aux】** button to enter into “Main” or “Aux” control mode, and press **【PLAY】** button to enter into “Playback” menu. You can use “Main” output to playback one channel and “Aux” output to playback another channel at the same time.

5.4 Main or Aux output to control PTZ

You can press **【Main/Aux】** button to enter into “Main” or “Aux” output control mode and press **【PTZ】** button to control one PTZ.

Please note if you enter into “PTZ” control mode, **【Main/Aux】** button is not effective until you press **【ESC】** button to exit PTZ control mode.

Only the users that have “Parameters Setup” right need read this chapter. When the following parameters are modified and saved, you must reboot the DVR to make the new parameters effective. Other parameters do not require you to reboot.

Chapter 6 Parameters Setup Guide

Only the users that have “Parameters Setup” right need read this chapter. When the following parameters are modified and saved, you must reboot the DVR to make the new parameters effective. Other parameters do not need to reboot.

- Any network parameters
- Stream type, resolution and record schedule
- External alarm sensor type
- View tampering alarm schedule
- Video lost alarm schedule
- Motion detection alarm schedule
- External alarm schedule
- Alarm output schedule
- Transaction
- RS232 work mode
- Change video output standard

6.1 Administrator and Password

When the DVR leaves the factory, there is one default administrator. The name is “admin” and password is “12345”. The name can not be changed, while the password can be.

Password modification

Press **【MENU】** key, in the login dialog box, select the username “admin”, use **【→】** key, to move cursor to password edit box, input “12345”, press “Confirm” to enter into administrator menu.

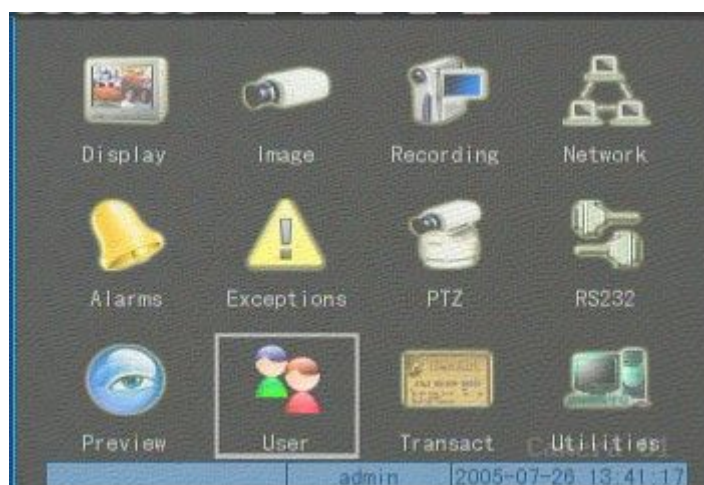

Move “Active Frame” to “User” icon, press **【ENTER】** key to enter into “User Management” menu.

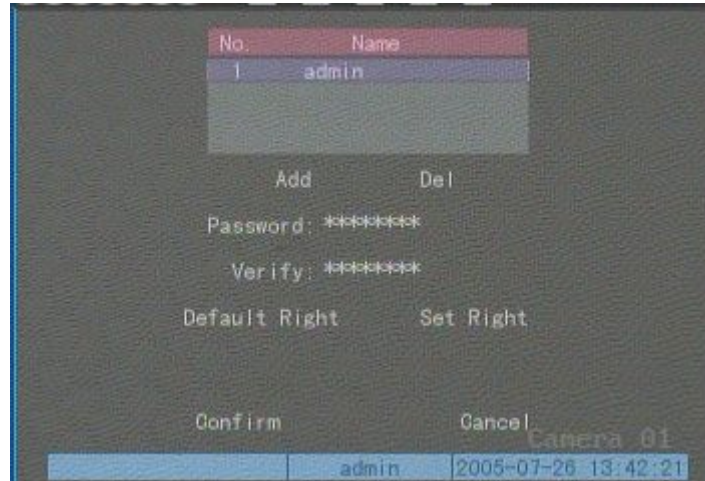

In the user name list box, only “admin” exists. You can use **【→】** key, move “Active Frame” to password edit box, and press **【EDIT】** key to enter into edit status. Press numeric keys to input the new password. The password is a combination of 16 numerals at most. After you finish inputting password, press **【ENTER】** key to exit. Move “Active Frame” to “Verify password” edit box, input the new password. Move “Active Frame” to “Confirm” button, and press **【ENTER】** , if new password and verified new password are the same, the password will be saved and take effect.

If password and verified password are not same, a warning message box will open.

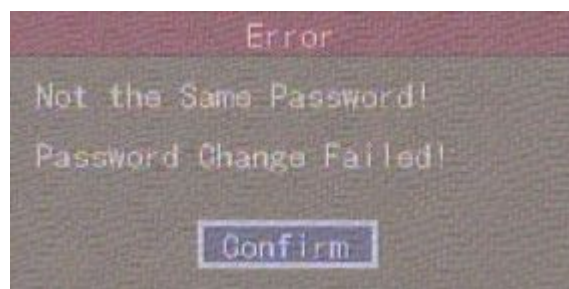

In this case, press **【ENTER】** to return to password edit box, and input new password again.

6.2 Add and Delete User

Enter into “User Management” interface.

Add user

The steps are as follows:

Step 1: Enter into “User Management” menu

Please refer to chapter 5.1



Step 2: Add new user name

In the “User Management” menu, move “Active Frame” to “Add” button and press **【ENTER】**, in the pop-up dialog box, input the new user name (refer to chapter 3.4), press **【ENTER】** and return “User Management” menu. 15 users can be added in all.

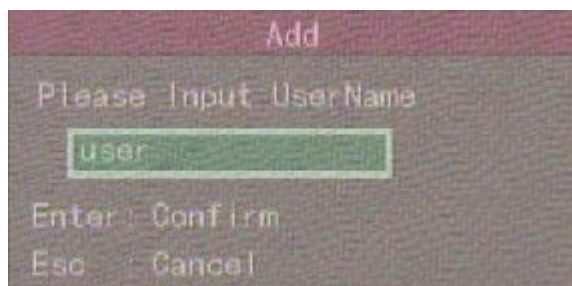

Step 3: Setup the password for new user

After you add a new user, the password is null. You can skip this step if you do not want to change the password.

In the users list box of “User Management” menu, use **【↑】** **【↓】** keys to select the new user name, then use **【→】** key to the password edit box. Press **【EDIT】** key to enter into edit box, use numeric keys to input the new password.

Step 3: Setup the rights for new user

The new added user has not any operational rights. You must setup rights for him.

In the users list box of “User Management” menu, use **【↑】** **【↓】** keys to select the new user name, then use **【→】** key to “Default Rights” button, press **【ENTER】**, the user will have the default rights. The default rights include local playback, remote playback and view log.

If you want to define the detail rights, move “Active Frame” to “Setup Rights” button and press **【ENTER】** to enter into rights setup menu as follows:

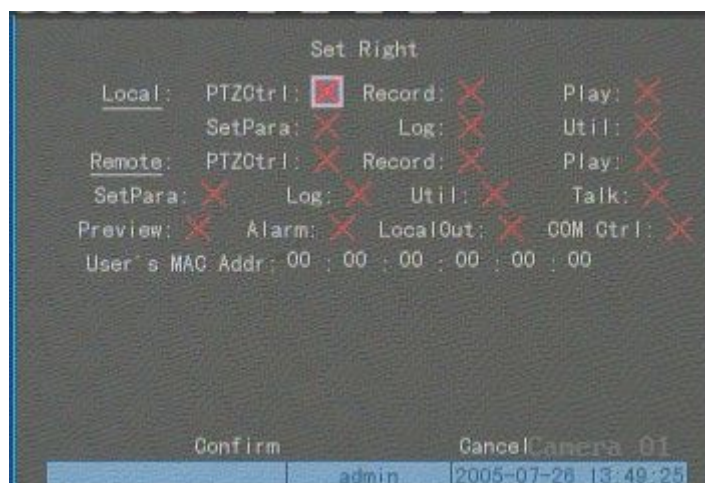

Operational rights are divided into “Local Rights” and “Remote Rights”. You can assign the necessary rights to the user. Use **【→】** **【←】** key to move “Active Frame” to the corresponding right items, press **【ENTER】** or **【EDIT】** key to enable or disable the item. “✓” means assigning the right to that user.

After you finish, press “Enter” button, the user’s rights will be saved and return to “User Management” menu. If you press “Cancel” button, the user’s rights will be aborted.

Step 4: Save the new user’s password and rights

In the “User Management” menu, press “Confirm” button, the user’s password and rights will be saved and you will return to main menu. If you press “Cancel” button, the user’s password and rights will be aborted.

User rights description

“Local Rights”:

Local rights are for local operation, such as the operation using front panel, IR controller and RS-485 keyboard.

PTZ control: Locally control PTZ;

Record: Manual start/stop recording;

Playback: Local playback and backup the recorded files;

Parameters Setup: Locally setup the DVR parameters;

Log: Locally view the log on DVR;

Utilities: Locally upgrade firmware, format HDD, reboot DVR and shut down DVR, etc.

“Remote Rights”:

PTZ Control: Remote control PTZ;

Record: Remote manual start/stop recording;

Playback: Remote playback, download the recorded files on DVR;

Parameters Setup: Remotely setup the DVR parameters;

Log: Remotely view the log on DVR;

Utilities: Remotely upgrade firmware, format HDD, reboot DVR and shut down DVR, etc.

Voice: Client talks with DVR;

Preview: Network live preview;

Alarm: Remote control DVR alarm output;

Local Video Out: Remote control DVR video output;

Com Control: DVR RS-232 transparent channel function.

MAC address

This MAC address is not the address of DVR but the PC that will access DVR. If you setup this MAC address, only the PC with this MAC address can access this DVR.

At PC end, in DOS prompt, you can use “ipconfig” command to get the PC MAC address (6 bytes).

Delete user

In “User Management” interface, you can use **【↑】****【↓】** keys to select one user, then use **【→】**, move “Active Frame” to “Del” button, press **【ENTER】**, in the pop-up confirmation dialog box, press “Confirm” button to delete the selected user and return. Press “Cancel” or **【ESC】** to abort deleting.

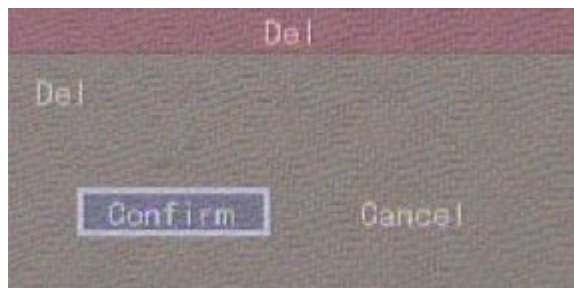

6.3 Unit Name and Device ID

Unit name

In the “Display” menu:

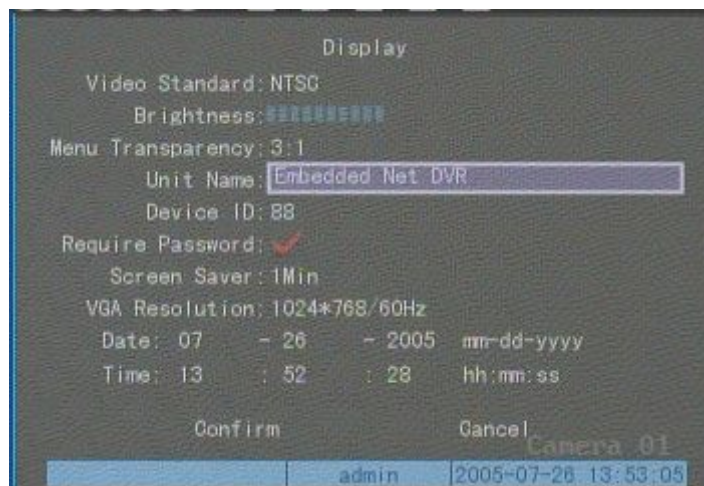

There is an item called “Unit Name”. The default unit name is “Embedded Net DVR”. Move “Active Frame” to unit name edit box, press **[EDIT]** key to enter into edit status, you can modify the unit name. For instructions on how to input characters, please refer to chapter 3.4. Press **[ENTER]** key to finish modification. Select “Confirm” button and press **[ENTER]**, you can save the new unit name and make it take effect. Press “Cancel” button or **[ESC]** key to abort modification.

Device ID:

When you use IR controller to operate DVR, you must use device ID to select DVR. The default device ID of the DVR is “88”. If there is more than one DVR in one place, please set a different device ID for each DVR. Otherwise, the IR controller will control all DVRs with the same device ID at the same time.

In “Display” menu, move “Active Frame” to the device ID edit box, in the edit status, you can use numeric keys to input a new device ID. The device ID can be set between 01-100.

After you finish the modification, press “Confirm” button to save and take effect or press “Cancel” to abort modification.

6.4 Video Output Standard and VGA Setup

Video output standard

There is one VOUT BNC connector at the rear panel of DVR. It is used to connect with an analog monitor and can support PAL or NTSC video output. You can modify video output standard to match video input.

In “Display” menu:

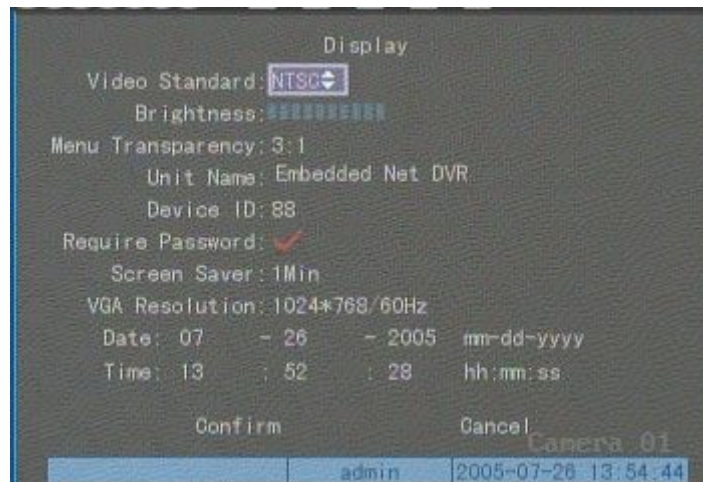

There is a list box called “Video Standard”, you can use **【↑】****【↓】** key to select PAL or NTSC video output.

VGA setup

There is one VGA interface on the rear panel of DVR. You can use it to connect with a VGA display. You can define VGA resolution and refresh frequency in “Display” menu.

There are three options: 1024*768/60Hz, 800*600/60Hz and 800*600/75Hz. You can use

【↑】**【↓】** key to select.

Press “Confirm” button to save or “Cancel” to abort.

6.5 OSD Setup

OSD is an abbreviation for “On Screen Display”. For our embedded net DVR models it includes displaying system time and camera name.

OSD settings include: System time, time format, time display position, camera name, camera name display position, etc.

System Time

In “Display” menu, you can setup DVR system date and time.

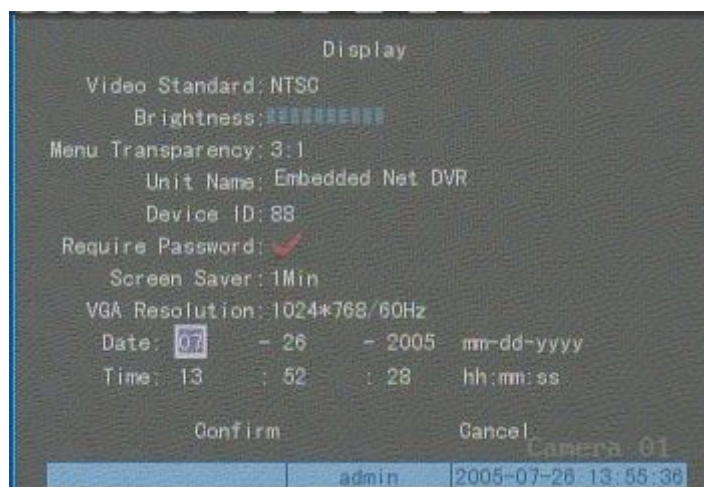

Display System Time

You can setup display properties for each camera, including display status, position and format. Of course, you can copy the properties of one camera to another camera or to all cameras.

In “Image Setup” menu select one camera:

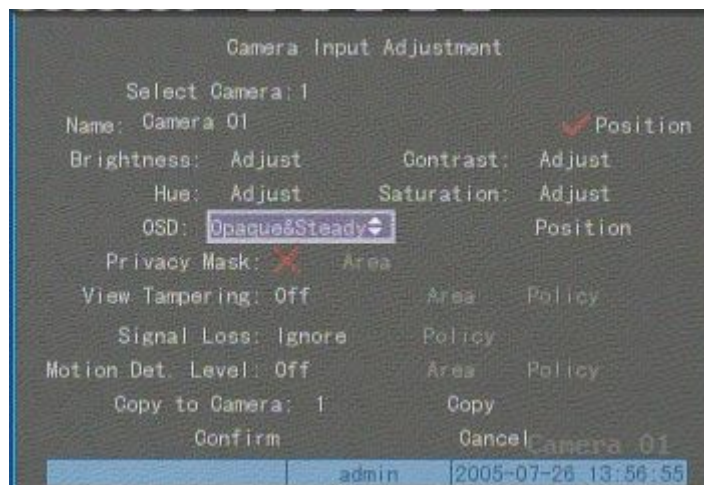

Display mode: There are several display modes: Opaque&Steady, Transparent&Steady, Transparent&Flashing, Opaque&Flashing,

Move “Active Frame” to “OSD” item, you can select one mode.

Display position and format: Move “Active Frame” to “Position” button on the right side of “OSD”, press **[ENTER]** to enter into setup image, there are 22*18 (for NTSC, 22*15) small panes, and OSD position is in red. You can use **[↓][↑][→][←]** keys to move the OSD position.

Press **[EDIT]** key to select OSD format. There are following OSD formats:

MM DD YYYY W hh:mm:ss (default)

MM DD YYYY hh:mm:ss

YYYY MM DD W hh:mm:ss

YYYY MM DD hh:mm:ss

Here YYYY means year, MM means month, DD means day, W means weekday, hh means hour, mm means minute and ss means second.

Press **[ENTER]** to save and return to “Image” menu or press **[ESC]** to abort modification.

Copy parameters: After you setup the properties of one camera, you can copy it’s parameter to any other camera or all cameras.

After you save the modification, it will become effective. You can press “Cancel” button or **[ESC]** key to abort.

Camera Name

In “Image Setup” menu, you can define name for each camera. **Please note that camera’s name can not be copied.**

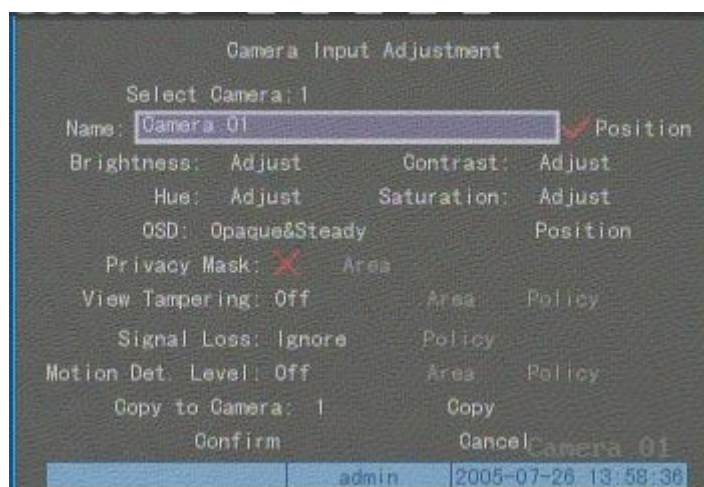

The steps for camera name setup:

Step 1: Select one camera.

Step 2: Move “Active Frame” to camera name edit box, press **【EDIT】** key to enter into edit status, you can input digital number, uppercase and lowercase characters (refer to Chapter 3.4). The camera name can support 32 characters.

Step 3: Press **【ENTER】** key to exit edit status.

Move “Active Frame” to “Confirm” button, press **【ENTER】** to save the modification and you can see the new camera name. Press “Cancel” button or **【ESC】** key to abort.

Setup Camera Name Position

If you do not want to display camera name, just disable the check box beside camera name edit box. The disable flag is “×”. If you enable the check box, you can setup the camera name position. You can copy the position to any other camera. The setup steps are:

Step 1: Enter into “Image Setup” menu.

Step 2: Select one camera.

Step 3: Enable the check box on the right side of camera name, then move “Active Frame” to “Position” button, press **【ENTER】** to enter into camera name position setup interface, in that interface, you can use **【↓】【↑】【→】【←】** keys to move camera name position. When the position is fixed, press **【ENTER】** and return “Image Setup” menu, and press “Confirm” button to save it. In the “Image Setup” menu, press “Cancel” button or **【ESC】** key, to abort the modification.

6.6 Video Parameters Setup

For different cameras and different backgrounds, in order to get the best video image, you may need to adjust video parameters such as brightness, saturation, contrast and hue, etc.

You can setup the cameras individually, and you can copy the video parameters of one camera to any other cameras. Here are the setup steps:

Step 1: Enter into “Image Setup” menu:

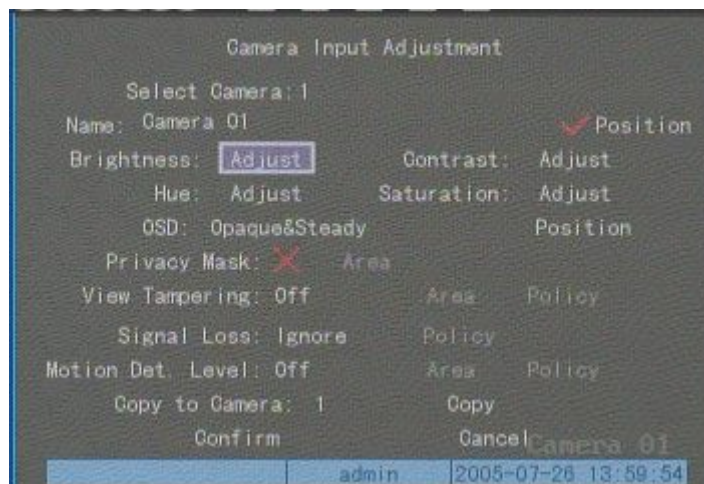

Step 2: Select camera: Please use **【↑】** **【↓】** keys to select one camera.

Step 3: Adjust brightness, contrast, saturation and hue: Move “Active Frame” to the “Adjust” button on the right side of Brightness, Contrast, Saturation and Hue, press **【ENTER】** key, you will enter into the corresponding adjust interface. In the adjust interface, there is one scroll bar at the bottom, you can use **【↑】** **【↓】** keys to adjust and the video image will be changed at the same time. When you are satisfied with the real time video image, press **【ENTER】** to return “Image Setup” menu.

Step 4: You can copy the video parameters of the current camera to any other cameras. Or you can repeat step2 and step3 to adjust for any other camera.

After adjust, in “Image Setup” menu, press “Confirm” button to save parameters and make them effective. Otherwise, press “Cancel” button or **【ESC】** key to abort modification.

6.7 Mask Area Setup

In some cases, you may want to mask a sensitive area. This area will not be previewed or recorded. The mask area setup steps are following:

Step 1: Enter into “Image Setup” menu:

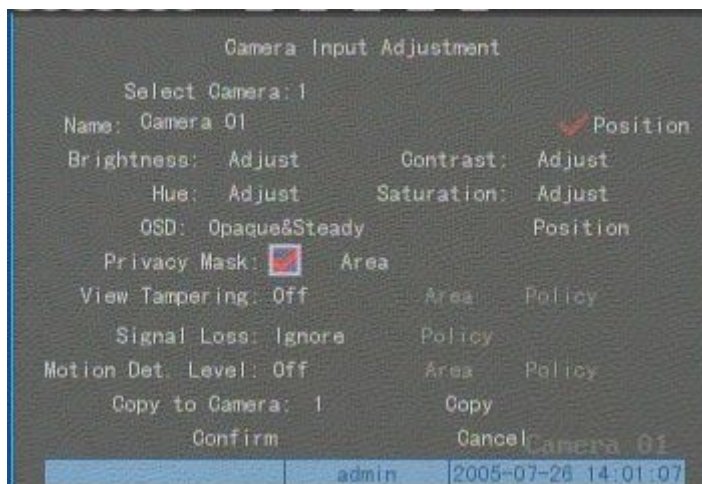

Step 2: Select a camera: You can use **【↑】** **【↓】** keys to select the camera.

Step 3: Enter into mask area setup interface: Enable the check box beside “Privacy Mask”, you can press **【EDIT】** key to change the flag into “✓”, and activate “Area” button. Move “Active Frame” to “Area” button on the right side of mask check box, press **【ENTER】** key to enter into mask area setup interface.

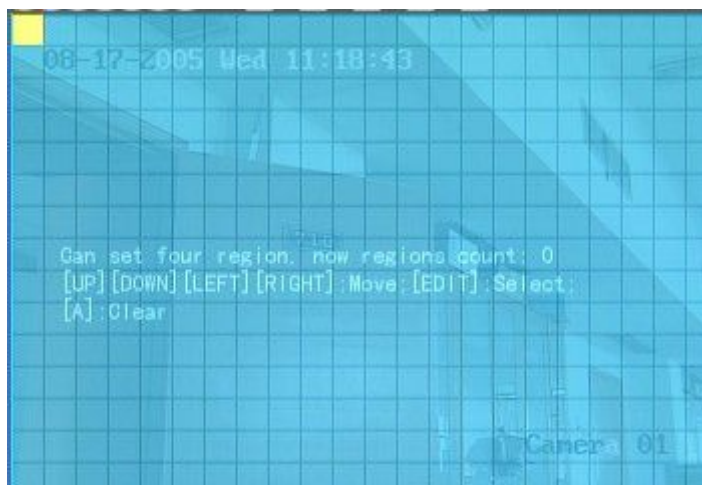

Step 4: Setup mask area: In the mask area setup interface, there is one small yellow pane on the upper left side. For PAL camera, the whole screen is divided into 22*18 panes (22*15 for NTSC), you can use **【↑】【↓】【→】【←】** keys to move the yellow pane to your desired position and press **【EDIT】** key, the yellow pane will be turned into red, then you can use **【↑】【↓】【→】【←】** keys to extend the red pane. This red area is the mask area.

After you select the red mask area, press **【EDIT】** key to save the mask area. Press **【ESC】** key to cancel the mask area. **The maximum mask area size is 8*8 panes and the minimum size is only one pane. You can setup 4 mask areas at most.**

After you finish setup, press **【ENTER】** key to return to “Image Setup” menu. **You can press 【A】 key to clear all mask areas.**

Step 5: Save mask area: You can repeat step2, step3 and step4 to setup mask area for other cameras. In “Image Setup” menu, press “Confirm” button to save the mask area, press “Cancel” button to abort.

Here is an example of the mask area function.



If you disable the mask check box, you can cancel the mask area.

6.8 View Tampering Alarm

If you enable this function, when someone blocks the camera spitefully, DVR will transmit a warning alarm.

Step 1: Enter into “Image Setup” menu:

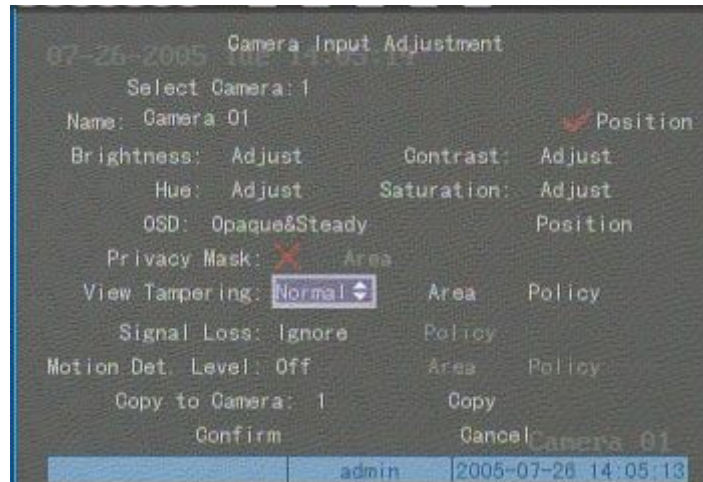

Step 2: Select camera: Please use **【↑】** **【↓】** keys to select one camera.

Step 3: Select sensitivity: You can use **【↑】** **【↓】** keys to select the sensitivity for “View Tampering” item. The sensitivity options are: Low, Normal and High. Select one of them to activate “Area Setup” and “Policy Setup” function.

Step 4: View tampering area setup: Move “Active Frame” to “Area” button, press **【ENTER】** key to enter into area setup interface. The setup methods are same as that of mask area setup. After setup the area, press **【ENTER】** key to return “Image Setup” menu. You can press **【ESC】** key to abort.

Only one view tampering area can be setup.

Step 5: View tampering alarm setup: In “Image Setup” menu, move “Active Frame” to “Policy” button, press **【ENTER】** key to enter into “View Tampering Handle” menu:

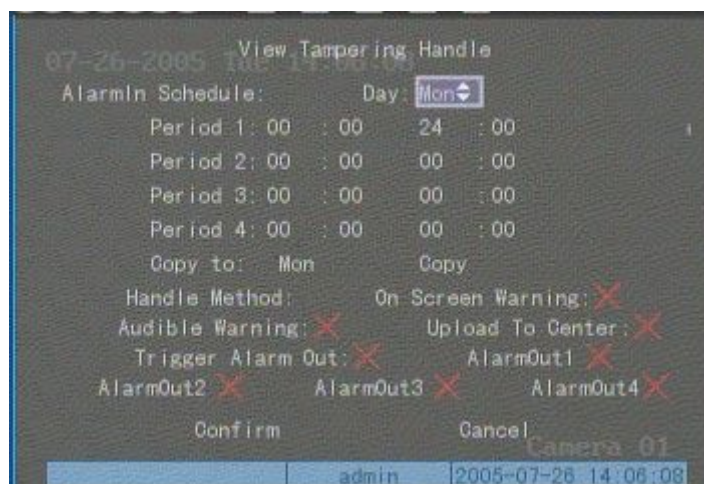

Step 6: Alarm schedule setup: When a view tampering alarm occurs, the DVR will handle the alarm based on the schedule. You can set 4 periods for each day one week. Also you can copy the schedule of one day to other days.

Notes: Time periods can not be repeated. Please reboot the DVR to make the setting effective.

Step 7: Setup alarm policy: If a view tampering alarm occurs during a schedule, the DVR will response based on the policy. You can select one or more solutions including “On Screen Warning”, “Audible Warning”, “Upload to Center” and “Trigger Alarm Output”. You can use **【↑】**

【↓】 and **【EDIT】** key to enable or disable them. “x” is disabled and “✓” is enabled.

Step 8: Save alarm setup: After you setup, press “Confirm” button and return to “Image Setup” interface. In “Image Setup” menu, press “Confirm” button to save current camera parameters and return to main menu.

Step 9: Save all cameras: If you want to setup other cameras, please repeat from step 2 to step 8. In “Image Setup” menu, press “Confirm” key to save all cameras parameters. Press “Cancel” button or **【ESC】** key to abort.

Select “Off” option for “View Tampering”, you can delete the view tampering area.

Note: Only one view tampering area can be setup for each camera. The view tampering area can not be copied. If the schedule is modified, you must reboot the DVR to make the parameters effective.

6.9 Video Loss Alarm

When the video cable or camera has something wrong, the video image is lost. If you enable video loss alarm, in such case, the DVR will send an alarm.

Step 1: Enter into “Image Setup” menu:

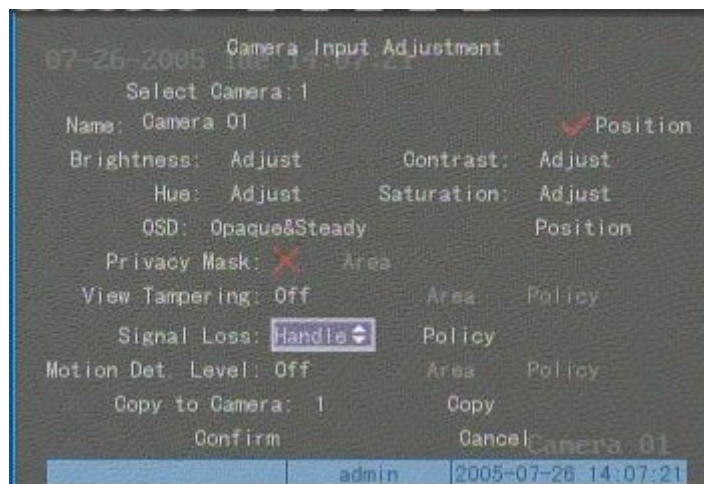

Step 2: Select camera: Use 【↑】 【↓】 keys to select one camera.

Step 3: Enter into “Video Signal Loss Handle” interface: Move “Active Frame” to the list box on the right side of “Video Loss” item, use 【↑】 key to select “Handle” option and move “Active Frame” to the “Policy” button on right side. Press 【ENTER】 to enter into “Video Signal Loss Handle” interface:

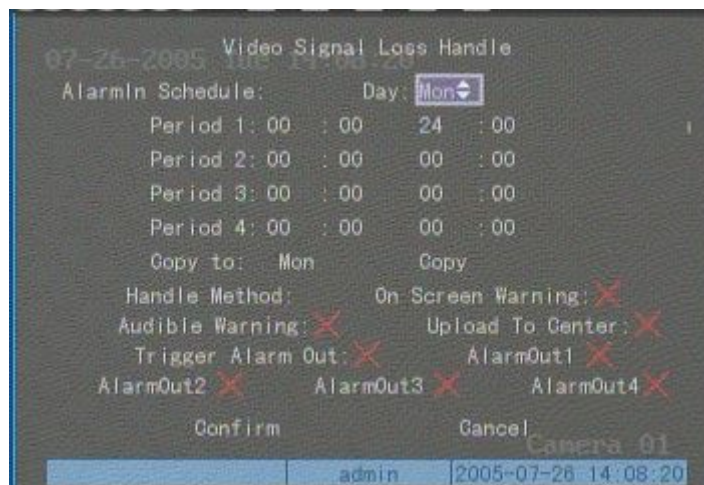

Step 4: Setup alarm schedule: You can setup a working schedule. Only when the video loss occurs during the schedule will the DVR respond.

Note: The 4 time periods can not be repeated. Please reboot the DVR to make parameters effective.

Step 5: Setup alarm policy: You can select one or more response solutions, including “On Screen Warning”, “Audible Warning”, “Upload to Center” and “Trigger Alarm Output”. You can use **【↑】** **【↓】** and **【EDIT】** key to enable or disable them. “×” is disabled and “✓” is enabled.

Step 6: Save alarm setup: After your setup, press “Confirm” button and return to “Image Setup” interface. In “Image Setup” menu, press “Confirm” button to save current camera parameters and return to main menu.

Step 7: Save all cameras: If you want to setup other cameras, please repeat from step 2 to step 6. In “Image Setup” menu, press “Confirm” key to save all cameras parameters. Press “Cancel” button or **【ESC】** key to abort.

6.10 Motion Detection Alarm

If you enable this function, when there is motion detected, DVR will make alarm.

Step 1: Enter into “Image Setup” menu:

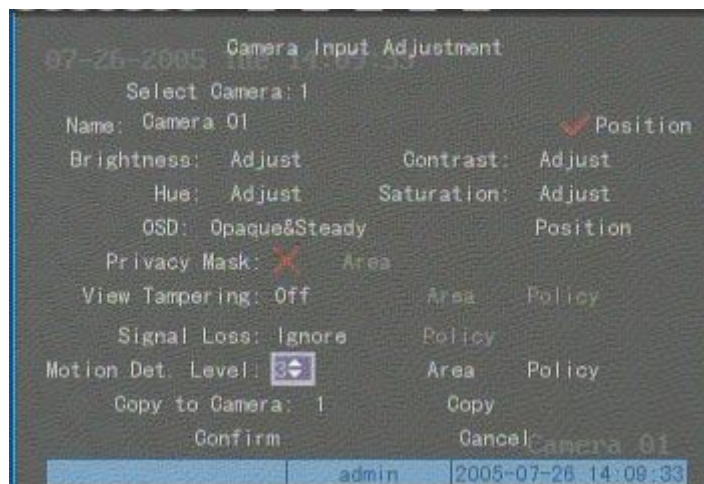

Step 2: Select camera: Use **【↑】** **【↓】** key to select one camera.

Step 3: Select motion detection sensitivity: On the right side of “Motion Det. Level” item, there is a list box. That is motion detection sensitivity. There are 7 options, from 0 (the lowest) to 5 (the highest) and “Off”. You can use **【↑】** **【↓】** keys to select one. If you select “Off” option, DVR will not respond even if motion is detected. If you select other options, it will active “Motion Area Setup” button and “Policy Setup” button. If you select low sensitivity such as 0, only when there are large amounts of motion will the DVR respond. On the other side, for high sensitivity such as 5, the DVR will respond to small amounts of motion.

Step 4: Motion area setup: You must define motion areas so that DVR will response when there is motion in those areas. Move “Active Frame” to “Area” button on the right side of sensitivity list box, press **【ENTER】** key, you can enter into “Motion Area Setup” interface.

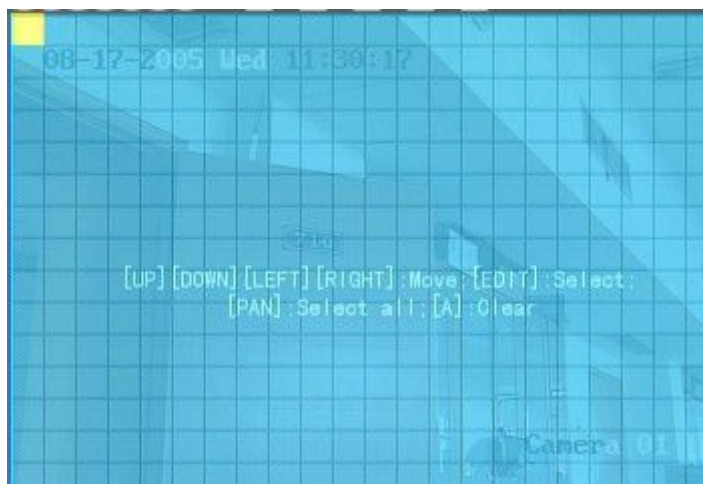

The whole screen is divided into 22*18 panes (NTSC: 22*15). There is one yellow panel on the upper left side. The motion area setup steps are the same as that of mask area setup (refer to chapter 5.7). The only differences are that you can use **【PTZ】** key to set the whole screen as motion area, and multiple motion areas can be defined. Press **【A】** key to clear all motion areas.

Setup multi areas: After you setup one motion area, press **【EDIT】** key, the yellow pane will appear again, then you can setup another motion area.

Clear motion area:

Clear part of motion area: Move the yellow pane to the start clear position of motion area, press **【EDIT】**, you will find the yellow pane is turned into black pane. You can use **【↓】** **【→】** keys to enlarge or shrink the black area. Press **【EDIT】** key to clear this part motion area.

Press **【Enter】** key to save and return to “Image” menu. Press **【ESC】** to cancel.

Clear all motion areas: Press **【A】** key to clear all motion areas of this channel.

The keys used to setup motion areas are as follows:

- **【↑】** **【↓】** **【←】** **【→】** : Move yellow panel to any position;
- **【EDIT】** : Yellow panel and red panel switch key;
- **【→】** : Right-enlarge red panel;
- **【←】** : Left-shrink red panel;

- 【↓】 : Down-enlarge red panel;
- 【↑】 : Up-shrink red panel;
- 【PTZ】 : Set whole screen as motion area;
- 【A】 : Clear all motion areas;
- 【ENTER】 : Save and return to “Image Setup” menu;
- 【ESC】 : Cancel setup and return to “Image Setup” menu;

The motion detection area is displayed as follows:

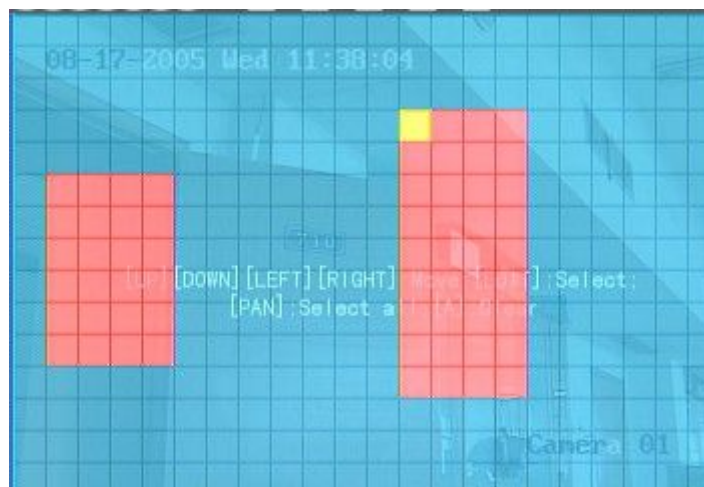

Step 5: Motion alarm policy: Move “Active Frame” to the corresponding “Policy” button of motion detection alarm, press 【ENTER】 key to enter into “Motion Alarm Handle” menu:

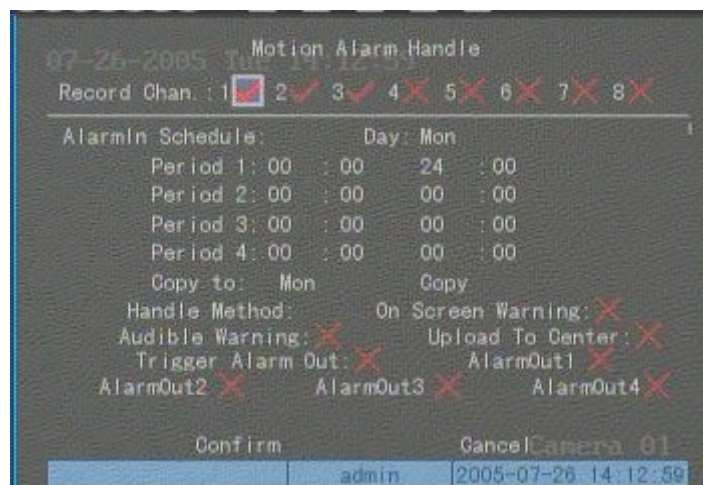

Step 6: Motion alarm record channel setup: When a motion alarm happens, you can

trigger related camera to start recording. In “Motion Alarm Handle” menu, you can select one or more record channels. Please use **[ENTER]** or **[EDIT]** key to change the flag to “✓”.

Note: In order to make the cameras start recording, in “Recording” menu, you must enable recording schedule and set “Rec Type” as “Motion Detection” or “Motion | Alarm”. Please refer to chapter 5.12 for recording setup.

Step 7: Motion alarm schedule: When the motion occurs during a schedule, DVR will respond with “On Screen Warning”, “Audible Warning”, “Upload to Center” or “Trigger Alarm Output”. You can setup 4 time periods for one day and 7 days for one week.

Note: Time periods in one day can not be repeated.

Step 8: Motion alarm handle method setup: You can select one or more handle methods such as “On Screen Warning”, “Audible Warning”, “Upload to Center” and “Trigger Alarm Output”.

Description: If “On Screen Warning” is enabled, when a motion alarm happens and DVR is in preview mode, DVR will display the related camera. If more than one camera is triggered the DVR will display them one by one every 10 seconds. When the motion alarm is has ended the DVR will return to preview mode.

Step 9: Save motion alarm setup: Press “Confirm” button to return “Image Setup” menu. In the “Image Setup” menu, press “Confirm” button to save the current camera parameters.

Step 10: Save all cameras: You can repeat from step2 to step8 to setup motion detection parameters for other cameras. You can also copy the parameters of one camera to any other camera or cameras.

Note: Motion alarm area can not be copied.

If you want to disable motion alarm area and motion alarm policy, you just need to select the motion alarm sensitivity as “Off”.

6.11 Preview Properties

In “Preview” menu, you can setup preview mode, screen switch time, enable or disable audio preview and preview layout.

Step 1: Enter into “Preview” menu: In the main menu, move “Active Frame” to “Preview” icon and press **[ENTER]** , you will enter into “preview” menu.

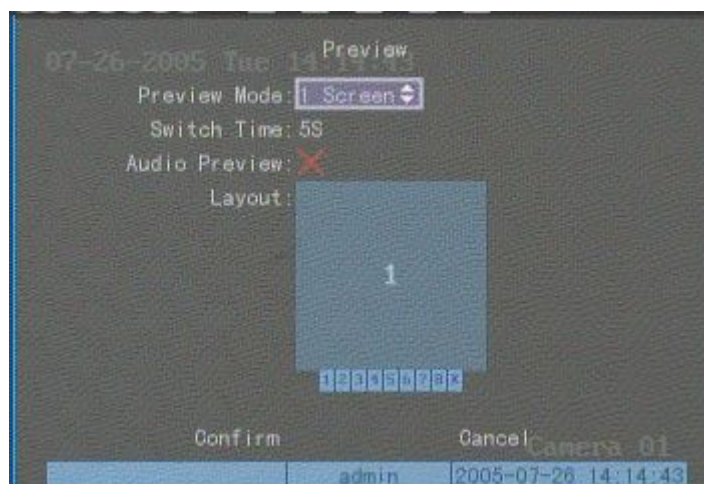

Step 2: Preview properties:

Preview mode: For preview mode item, you can use **【↑】【↓】** key to select one mode. If DVR has only 1 channel, you can select only “1 Screen” option. If DVR has 4 channels, there are “1 Screen” and “4 Screen” options. If DVR has more than 4 but less than 9 channels, there are “1 Screen”, “4 Screen” and “9 Screen” options. If DVR has 16 channels, there are “1 Screen”, “4 Screen”, “9 Screen”, “12 Screen” and “16 Screen” options.

Switch time: That is image preview switch time. You can use **【↑】【↓】** keys to select switch time. There are many options, including “5 Seconds”, “10 Seconds”, “20 Seconds”, “30 Seconds”, “60 seconds”, “120 seconds”, “600 seconds” and “Never”. If you select “Never”, the preview image will not be switched automatically. For example, for 16 channel DVR, if you select “4 Screen” preview mode and “20 Seconds” switch time, DVR will cycle display 4 channels image every 20 seconds.

Audio preview: If you enable audio preview (“✓”), when you preview single camera, DVR will play the audio of that channel.

Preview layout setup: There is a square frame divided into many windows. If you select “4 Screen” preview mode, this frame is divided into 4 windows. Each window represents one camera. You can move “Active Frame” among the windows. There is one bar under the square to display the preview order of all cameras.

First select the biggest screen preview mode, for example, for 16-channel DVR, select “16 Screen” preview mode so that all windows are display in the square.

Second, move “Active Frame” to one of these windows, press numeric keys to input camera index (If DVR has less than 10 channels, just use one numeric key, otherwise, use 2 numeric keys). The small window will display that camera number. In this way you can change the display order. If you press 0 or 00, then the corresponding window will not display live video.

After you define the camera preview order, you can select preview mode to meet your needs.

Save setup: Press “Confirm” button to save preview properties. Press “Cancel” or **【ESC】** key to abort.

6.12 Recording Setup

In main menu, there is an icon named “Recording”. You can enter into recording menu as follows:

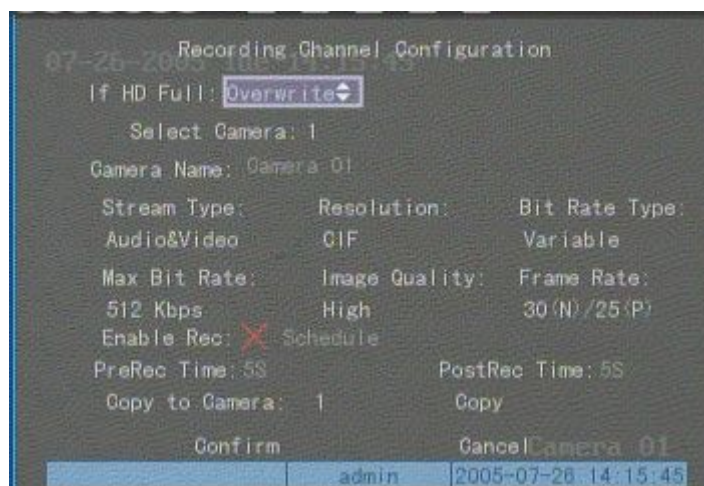

“Recording” menu description:

If HD Full: There are two options: “Overwrite” and “Stop recording”. If you select “Overwrite” option, when all HDDs in DVR are full, DVR will overwrite the earliest recorded files and continue recording. If you select “Stop recording” option, when all HDDs are all full, DVR will handle it as “Hard Disk Full” exception, please refer to chapter 5.17 for exception menu.

Select Camera: Here all channels are listed. You can use **【↑】** **【↓】** keys to select one.

Stream Type: There are two options, one is “Audio&Video” stream and the other is “Video” stream only. If you want to record video and audio, please select “Audio&Video” option, otherwise you can select “Video” option to record only video.

Note: If you change this option, please reboot DVR to make parameter into effective.

Resolution: The higher the resolution is, the clearer the image is. The resolution options from low to high are: QCIF, CIF, 2CIF, DCIF, 4CIF depending on model.

For QSD42208, QSC26408, and QSC26416 DVRs: All channels can support QCIF and CIF resolution.

For QSF2648008 and QSF2648016 DVRs: All channels can support QCIF, CIF, 2CIF, DCIF and 4CIF resolution.

Note: If you change this resolution option, please reboot DVR to make it into effective.

Bit Rate Type: There are two options: “Variable” and “Fixed”.

If you select variable bit rate, DVR will adjust the actual bit rate according to the video movement. When there is not much movement, DVR will use low bit rate, when there is much movement, DVR will use high bit rate. In this case, DVR can save HDD usage and network bandwidth.

If you select fixed bit rate, DVR will use the fixed bit rate to compress image. The bit rate size is defined in “Max Bit Rate” option. In this case, we can calculate the recorded file size and network bandwidth that we need.

Max Bit Rate: If you select variable bit rate, when the video input has great movement, we need to limit the max bit rate. The max bit rate has the following options (bps): 32K, 48K, 64K, 80K, 96K, 128K, 160K, 192K, 224K, 256K, 320K, 384K, 448K, 512K, 640K, 768K, 896K, 1M, 1.25M, 1.5M, 1.75M, 2M and “User define”.

The max bit rate selection is related to resolution. If you select high resolution, you must select high bit rate. For CIF resolution, the typical max bit rate is 384K-768Kbps. For DCIF resolution, the typical bit rate is 512K-1Mbps. For 4CIF resolution, the typical bit rate is 1.25Mbps-1.75Mbps. Of course, you will select the proper max bit rate based on the camera, background and image quality requirement.

Bit rate: You can select bit rate size for fixed bit rate type. It is the same as “Max Bit Rate”.

Image Quality: If you select variable bit rate type, you can define image quality. There are 6 options: Highest, Higher, High, Average, Low and Lowest. High image quality needs high bit rate size.

Frame Rate: Frames per second. Options are: Full (PAL is 25 FPS and NTSC is 30FPS), 20, 16, 12, 10, 8, 6, 4, 2, 1, 1/2, 1/4, 1/8, 1/16. For low frame rate, you can select low bit rate size.

PreRecord Time: When you enable motion detection recording or external alarm recording, you can define prerecord time. The options are: No PreRecord, 5 Seconds (default selection), 10 Seconds, 15 Seconds, 20 Seconds, 25 Seconds, 30 Seconds and Max PreRecord.

MaxPreRecord is to save all data in PreRecord buffer. The PreRecord time is related with bit rate. The lower bit rate, the longer PreRecord time is.

If the bit rate (Max bit rate) is very low, and you select “PreRecord Time” as “5 Seconds”, maybe the actual perrecord time is more than 5 seconds. On the other side, if the bit rate is high, and set “PreRecord Time” as “30 Seconds”, the actual pre-record time is less than 30 seconds.

PostRecord Time: When external alarm or motion alarm is stopped, DVR will continue recording time. The options are: 5 Seconds (default), 10 Seconds, 30 Seconds, 1 Minute, 2 Minutes, 5 Minutes and 10 Minutes.

Enable Rec: Enable or disable selected camera record function. “×” means disable and “✓” means enable.

Schedule: When you enable recording function, you can setup recording schedule.

Note: When the camera’s recording schedule is modified, you must reboot DVR to make it effective.

All day recording setup:

Step 1: Enter into recording schedule menu

In recording menu, use **[ENTER]** or **[EDIT]** key to enable record function (“✓” flag), press “Schedule” button to enter into recording schedule menu:

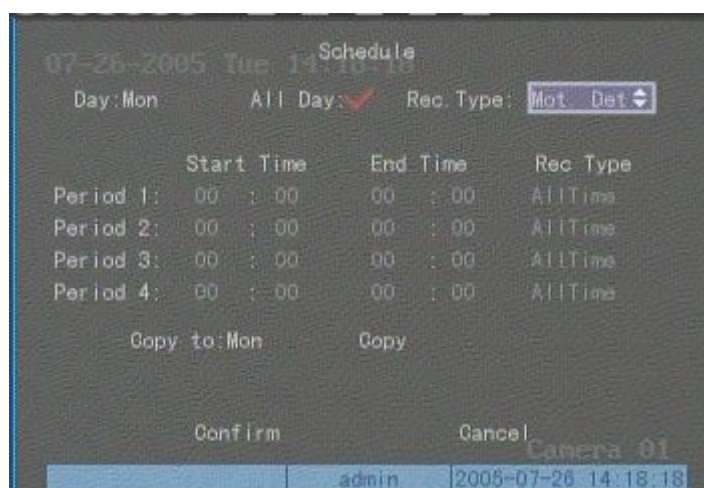

Step 2: Select one day and enable all day recording option

For “Day” item the options are: Monday, Tuesday, Wednesday, Thursday, Friday, Saturday and Sunday. Use **[↑]** **[↓]** keys to select one day. Move “Active Frame” to the check box on the right side of “All Day” item, press **[ENTER]** or **[EDIT]** key to enable “All Day” option. “×” means disable and “✓” means enable.

Step 3: Record type

For “Rec Type” item, the options are: All Time, Motion Detect, Alarm, Motion|Alarm, and Motion&Alarm.

For all day record mode, only one record type can be selected.

Step 4: Copy to other days

You can repeat step 2 and step 3 to setup for other days. Also you can copy the current day to other days.

Step 5: Save

Press “Confirm” back to “Recording” menu. Press “Confirm” again to save the parameters and return main menu.

None all day recording setup**Step 1: Enter into recording schedule menu**

In recording menu, use **[ENTER]** or **[EDIT]** key to enable record function (“✓” flag), press “Schedule” button to enter into recording schedule menu.

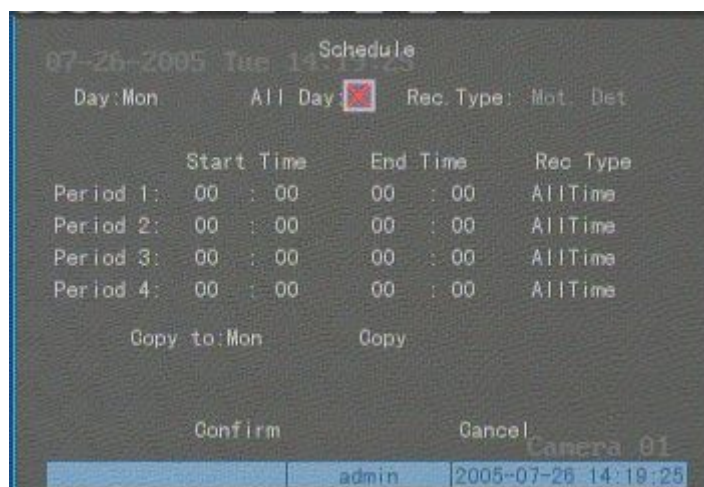
**Step 2: Select one day and disable all day recording option**

For “Day” item the options are: Monday, Tuesday, Wednesday, Thursday, Friday, Saturday and Sunday. Use **[↑]** **[↓]** keys to select one day. Move “Active Frame” to the check box on the right side of “All Day” item, press **[ENTER]** or **[EDIT]** key to disable “All Day” option. “x” means disabled and “✓” means enabled.

Step 3: Setup time period and record type

There are 4 time periods for one day, and each time period can select different record types. Input start time and stop time for each time period, and select record type for each period. The record type options are: All Time, Motion Detect, Alarm, Motion&Alarm and Motion|Alarm.

Note: The time periods in one day can not be repeated.

Step 4: Copy to other days

You can repeat step2 and step 3 to setup for other days. Also you can copy the current day to other days.

Step 5: Save

Press “Confirm” you go back to “Recording” menu. Press “Confirm” again to save the parameters and return to main menu.

Note:

- 1) If record type is “Motion Detect” or other related types, you must setup “Motion Detection” in order to trigger motion recording (refer to chapter 5.10).
- 2) If record type is “Alarm” or other related types, you must setup “Alarms” in order to trigger alarm recording (refer to chapter 5.13).
- 3) The time period is among 00:00—24:00.

6.13 External Alarm Input and Relay Output

For 8-channel DVR, there are 8 external alarm inputs and 4 relay outputs. For 16-channel DVR, there are 16 external alarm inputs and 4 relay outputs. In “Alarms” menu, you can setup each external alarm input.

In main menu, move “Active Frame” to “Alarms” icon and press **【ENTER】** key to enter into alarms menu:

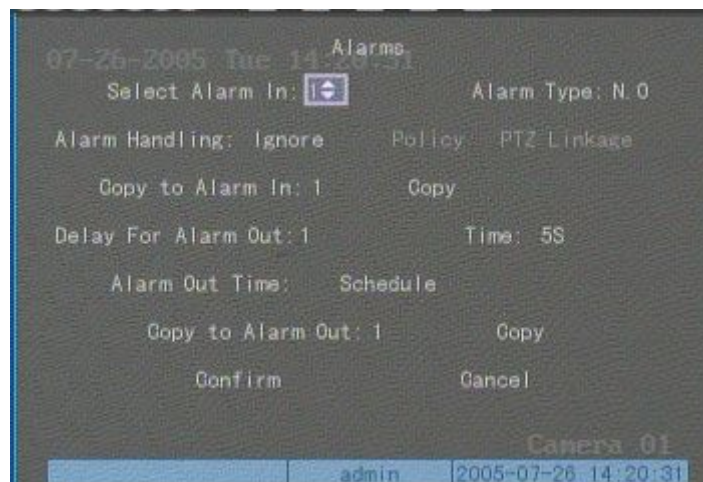

External alarm input setup:

Step 1: Select one alarm input Use **【↑】** **【↓】** keys to select one alarm input.

Step 2: Alarm type

This is sensor type. You can select “Normal Open” or “Normal Close” according to the sensor type.

Step 3: Enter into “Alarm in Handling” sub menu

In the “Alarms” menu, there are two options for “Alarm Handling” item. One is “Ignore”,

and the other is “Handle”. If you select “Handle” option, you can activate “Policy” and “PTZ Linkage” buttons on right side. Move “Active Frame” to “Policy” button and press **[ENTER]** key, you will enter into “Alarm in Handling” sub menu:

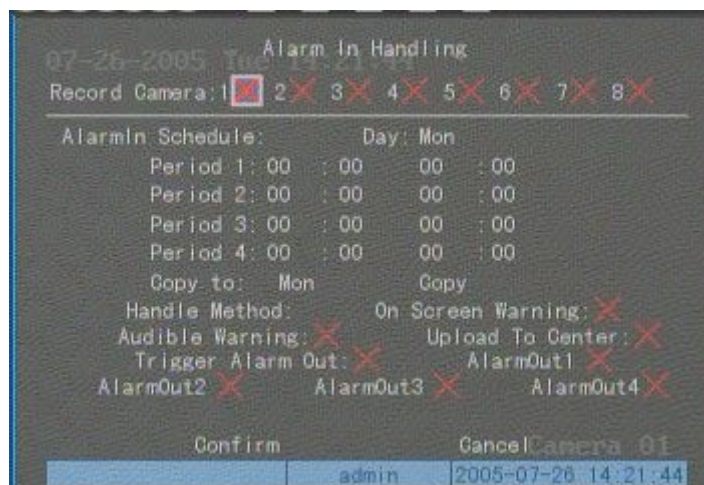

Step 4: Alarm trigger record channel setup

You can select channels to record for each alarm input. In the sub menu, you can use **[ENTER]** or **[EDIT]** key to enable record channel. “x” means disable and “✓” means enable.

Note: In order to trigger the channel to record, in “Recording” menu, you must enable recording and select record type as “Alarm” or other related type. Please refer to chapter 5.12.

Step 5: Schedule for alarm handle method

When an external alarm occurs in the schedule, the DVR will respond according to the handle methods.

Step 6: Alarm handle method

You can select one or more handle methods: “On Screen Warning”, “Audible Warning”, “Upload to Center” and “Trigger Alarm Output”.

Description: If “On Screen Warning” is enabled, when an external alarm happens and DVR is in preview mode, DVR will display the related camera. If you trigger more than one camera, DVR will display them one by one every 10 seconds. When the external alarm ends, the DVR will return to preview mode.

Step 7: Save setup

In “Alarm in Handling” sub menu, press “Confirm” button and return to “Alarms” menu. In “Alarms” menu, press “Confirm” button to save the parameters.

Step 8: PTZ Linkage

Move “Active Frame” to “PTZ Linkage” button, press **【ENTER】** key to enter into “PTZ Linkage” setup menu:

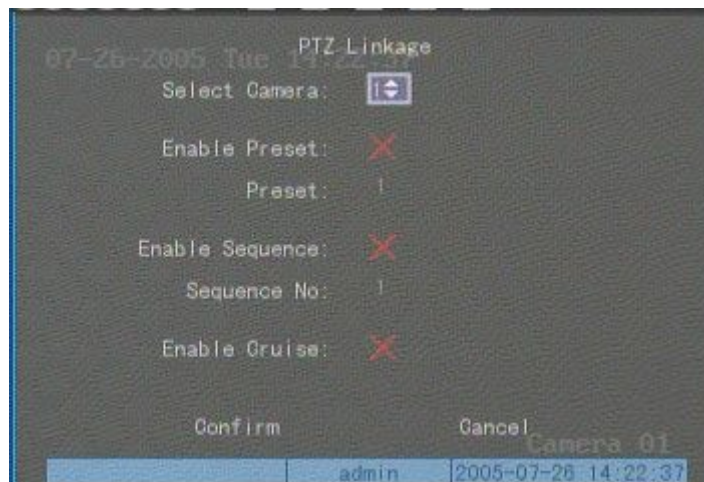

First select one camera, then select one of following PTZ linkage:

- Preset: Set the flag as “✓” to enable preset, in the preset number edit box and input one preset number that has been setup already. Please refer to chapter 6.15 for preset setup.
 - Sequence: Set the flag as “✓” to enable sequence and input one sequence number that has been setup already. Please refer to chapter 6.15 for sequence setup.
 - Cruise: Set the flag as “✓” to enable cruise. Please refer to chapter 6.15 for cruise setup.
- Press “Confirm” button to save and return to “Alarms” menu. Press “Cancel” button or

【ESC】 key to abort and return to “Alarms” menu.

Note: Please make sure that the PTZ you are using can support preset, sequence and cruise functions. One external alarm input can trigger many cameras PTZ linkage.

Step 9: Copy the parameters to other external alarm inputs: You can copy the parameters of current alarm input to other external inputs.

Step 10: Save setup: In “Alarms” menu, press “Confirm” button to save the parameters. Press “Cancel” button or **【ESC】** key to abort.

Alarm relay output setup

Step 1: In “Alarms” menu, use **【↑】** **【↓】** keys to select one alarm output.

Step 2: Select delay time

The delay time is when the alarm has stopped, the alarm output will continue to output for a specified time. The delay time options are: 5 Seconds, 10 Seconds, 30 Seconds, 1 Minute, 2

Minutes, 5 Minutes, 10 Minutes and Manual Stop. If you select “Manual” option, the alarm output will not stop until you press the “Clear Alarm” button in “Utilities” menu. So the actual alarm output time is made up of alarm input time and this delay time.

Step 3: Enter into alarm out schedule

You can set the schedule to make alarm output effective. Move “Active Frame” to “Schedule” button on right side of “Alarm Out Time” item, press **[ENTER]** key to enter into the corresponding schedule menu:

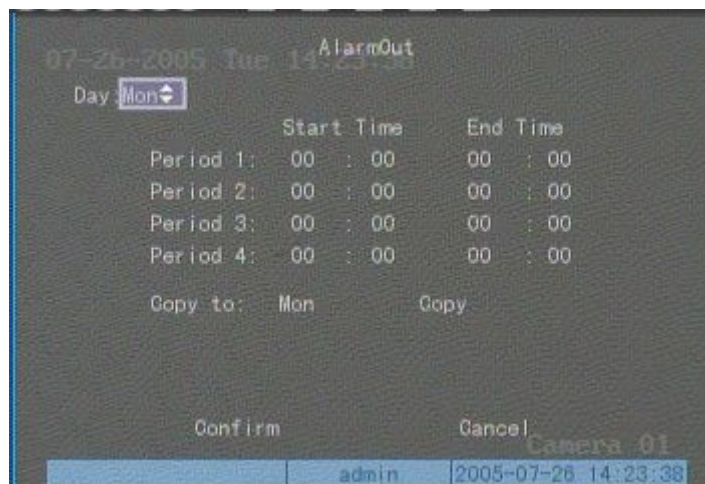

Step 4: Setup alarm out schedule

Like other schedule setup, you can set 4 time periods for one day and 7 days for one week. When you finish setup, press “Confirm” button to return to “Alarms” menu.

Step 5: Copy one alarm output parameters to other alarm outputs

In “Alarms” menu, you can copy parameters of current alarm output to other alarm outputs.

Step 6: Save setup

When you finish setup, in “Alarms” menu, press “Confirm” button to save all parameters.

Note: If any schedule is modified, you must reboot DVR to make it effective.

6.14 Network Parameters

If you want to access the DVR over a network you must setup network parameters.

Note: If any network parameter is modified, you must save and reboot DVR to make it effective.

In main menu, move “Active Frame” to “Network” icon and press **[ENTER]** , you can enter into “Network” menu as follows:



“Network” menu description:

***NIC type:** Default is “10M/100M Auto”, the other options are: 10M Half-Dup, 10M Full-Dup, 100M Half-Dup and 100M Full-Dup.

***IP address:** This IP address must not conflict with other IP addresses. If there is DHCP server in the network, you can set the IP as “0.0.0.0”, save and reboot DVR. In reboot process, DVR will search the DHCP server and get a dynamic IP address. This item will display the dynamic IP address. If DVR uses PPPoE function, the DVR can dial into internet and this item will display the dynamic internet IP address.

***Port:** Network access port number, must be greater than 2000.

***Mask:** This is sub net mask.

Gateway: The gateway IP is used to communicate with different network segments, it is the network IP of the router the DVR is attached to.

DNS address: If DVR uses PPPoE function, and gets a dynamic IP address. If you set DNS IP with one fixed Internet IP, DVR will send some information such as DVR name, DVR serial

number, DVR current IP to that fixed IP address. We call that fixed Internet IP as DNS IP. The DNS server with that fixed Internet IP can receive DVR information and used to provide DVR with a dynamic IP address.

This DNS is special software, not the normal domain name server. You can use SDK to develop this DNS software (available on request).

Multicast IP: It is one D-class IP address, among 224.0.0.0 --- 239.255.255.255. If you do not use multicast function, you do not need to set. Some routers will prohibit multicast function in case of network storm.

Remote Host IP and Port: If you set this IP and port, when there is alarm and exception happens, the DVR will send information to that host IP. The center with this IP can receive alarm and exception information from DVR. You can use SDK to develop this center software (available on request).

NAS: Network access storage. DVR will regard network HDD as local HDD. If you enable this function, DVR will send and save the real time image to that network HDD.

NFS IP: The IP of that network storage server.

Dir: The directory name shared by that network storage server.

This function is not currently available.

HttpPort: The port is for IE browser. The default value is 80. It can be modified.

PPPoE: DVR supports PPPoE dail-up function.

Example: Use PPPoE function

Step 1: Enter into “Network” menu.

Step 2: Select NIC type.

Step 3: Input port number. In the port edit box, use numeric keys to input port number. The port number must be more than 2000.

Step 4: Input DNS IP. Input one fixed Internet IP address where the IP analyst software (IPServer) is run.

Step 5: Input PPPoE parameters. Use **【ENTER】** or **【EDIT】** key to enable PPPoE function (set PPPoE flag as “√”). Input PPPoE username, password and verify password that ISP provided.

Step 6: Save parameters. In “Network” menu, press “Confirm” to save parameters. Reboot DVR to make parameters effective. In reboot process, DVR will start dialup using PPPoE function. If DVR dials up internet successfully, DVR will display the dynamic internet IP address in “Network” menu.

6.141 Accessing the DVR over a network

To access the DVR through a computer you need to make sure the default gateway on the DVR is the same IP address as your router, and the first three sets of numbers of the DVR IP address are the same as the first three sets of numbers of router's address. Example: if your router's default gateway is 192.168.1.1 then the default gateway setting in the DVR should be 192.168.1.1, and the first three sets of numbers on the DVR's IP address should be 192.168.1. The last set of numbers has to be different than those on any other devices attached to the router to avoid conflicts. The subnet on the DVR also needs to be the same as the router, example: if the subnet on the router is 255.255.255.0 the subnet on the DVR needs to be 255.255.255.0. To get the default gateway and subnet of the router, on a computer that is attached to the same router as the DVR, click on the start button, then click on run, then enter cmd into the box and click on OK. At the cursor type ipconfig, the default gateway and subnet will be displayed.

You can access the DVR through an Internet Explorer browser window, or through the included client software program.

To access the DVR through Internet Explorer: once you have set up the network settings on the DVR to match the settings of your router, you need to modify your browser controls. You need to allow Pop-ups. To do so go to the Internet Explorer tool bar and select the "tools" option, then select the "Pop up Blocker" option and select "Turn Off Pop-up Blocker." You will also need to enable Active X controls. To do so go to the Internet Explorer tool bar and select the "tools" option, then "Internet Options", then "Security", then click the "Custom Level" button, and make sure the Active X Controls and Plug Ins are set to prompt or enabled. To connect to the DVR from the computer you would then open an internet browser window and enter the gateway IP of your router. You will get a login screen where you will need to enter your user name and password (admin and 12345 by default). The first time you connect a webcam program will be downloaded to your system and you may get a message that an ActiveX control on the page may be unsafe but it is ok to click the Yes option to download the control and program since you have requested the program. This will take you to the Internet Explorer Webcam screen. You would click on the Camera Icon to display cameras.

If you wish to access the DVR through the included client software follow the installation instructions on the included manual.

6.142 Accessing the DVR from a remote computer

To access the DVR from a remote computer, in addition to the above steps, you will also need to forward ports 80 and 8000 on the router the DVR is attached to, to the IP address of the DVR. How you would do this depends on the brand and model number of your router. You can go to www.portforward.com to get instructions on how to forward ports on most popular routers. To access your router's program you would open an internet browser window and type the default gateway of the router into the address bar at the top of the window. Then follow the instructions for your router.

You can access the DVR through an Internet Explorer browser window, or through the included client software program.

To access the DVR through Internet Explorer: once you have setup the network settings on the DVR to match the settings of your router and forwarded the ports needed by the DVR, you need to modify your browser controls. You need to allow Pop-ups. To do so go to the Internet Explorer tool bar and select the "tools" option, then select the "Pop up Blocker" option and select "Turn Off Pop-up Blocker." You will also need to enable Active X controls. To do so go to the Internet Explorer tool bar and select the "tools" option, then "Internet Options", then "Security", then click the "Custom Level" button, and make sure the Active X Controls and Plug Ins are set to prompt or enabled. To connect to the DVR from the remote computer you would then open an internet browser window and enter the internet IP of your router. To get the internet IP of your router go to www.myipaddress.com from a computer that is attached to the same router as the DVR. You would then access the DVR by typing the IP address you got from www.myipaddress.com into the browser window (Example:http://70.69.120.123). You will get a login screen were you will need to enter your user name and password (admin and 12345 by default). The first time you connect a webcam program will be downloaded to your system and you may get a message that an ActiveX control on the page may be unsafe but it is ok to click the Yes option to download the control and program since you requested the program. This will take you to the Internet Explorer Webcam screen. You would click on the Camera Icon to display cameras. **If you wish to access the DVR through the included client software follow the installation instructions on the included manual.**

6.15 PTZ

There is one RS-485 port at DVR rear panel used for PTZ control. You can setup RS-485 parameters to match your PTZ protocol. In main menu, move “Active Frame” to PTZ icon and press **【ENTER】** key, you can enter into PTZ menu as follows:

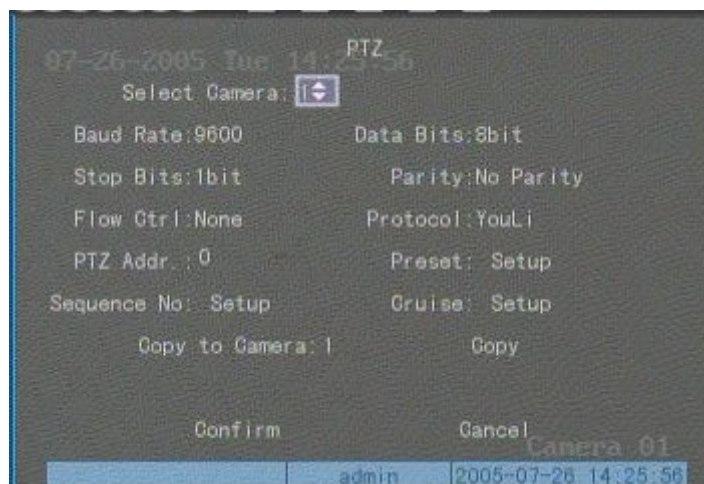

PTZ menu description

Select channel: Select one PTZ camera.

RS-485 parameters: Including baudrate, data bit, stop bit, parity, flow control, etc. These parameters must be the same as those of PTZ. Protocol.

PTZ address: Each PTZ has one different address.

PTZ type: DVR supports the following PTZ protocols: YouLi, LinLin-1016, LinLin-820, Pelco-p, DM DynaColor, HD600, JC-4116, Pelco-d WX, Pelco-D, VCOM VC-2000, NetStreamer, SAE/YAAN, Samsung, Kalatel-312, CELOTEX, TLPelco-p, TLHHX-2000, BBV, RM110, KC3360S, ACES, ALSON, INV3609HD, Howell, Tc Pelco P, Tc Pelco D, AUTO-M, AUTO-H, ANTEN, CHANGLIN, DeltaDome, XYM-12, ADR8060, EVI-D30, DEMO-SPEED, DM-PELCO-D, ST832, LC-D2104, HUNTER, A01, TECHYIN, WEIHAN, LG, D-MAX, Panasonic, KTD-348, infinova, PIH-7625, LCU, DennaDome, etc. Other PTZ protocols may be added through new firmware.

Note: In DVR “PTZ” menu, if you select Pelco-P protocol, when you setup PTZ address, please use 1 number higher or lower then the Camera ID. For example, if camera ID is 2, the DVR PTZ address is set as ID 3.

Preset setup: Preset is using one number to represent the camera’s position, zoom, focus and iris. Move “Active Frame” to “Setup” button on the right side of “Preset” item, press **【ENTER】**

key to enter into preset setup menu. You can save 128 preset numbers. Please make sure the PTZ supports preset function before you setup preset.

Sequence setup: Each sequence is made up of several cruise points. Each cruise point includes one preset number, dwell time and dwell speed. Please make sure the PTZ you are using can support sequence function before you start to setup. You can save 16 sequences.

Cruise setup: Cruise is remembering the track of PTZ movement. Please make sure the PTZ you are using can support cruise function.

Preset setup

In “PTZ” menu, move “Active Frame” to “Setup” button on the right side of “Preset” item, press **【ENTER】**, you can enter into “Preset” setup menu:

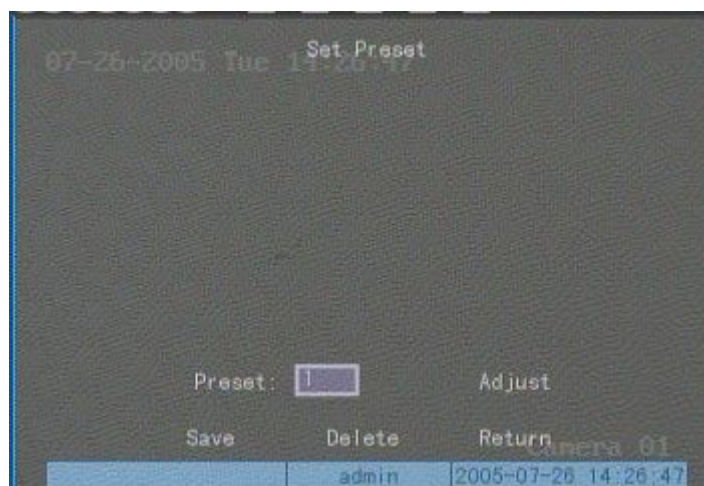

Add preset number: You can input preset number (among 1-128) in the edit box. Then press “Adjust” button to enter into PTZ control interface. In PTZ control interface, you can use direction keys to adjust PTZ position, and use **【IRIS+】【IRIS-】【FOCUS+】【FOCUS-】【ZOOM+】【ZOOM-】** keys to adjust iris, focus and zoom. After you finish adjusting, press **【ENTER】**, then press “Save” button to save the preset number. You can repeat this step to setup other preset numbers.

After you setup all preset numbers, press “Return” button to return to “PTZ” menu. In “PTZ” menu, press “Confirm” button to save all parameters.

Delete preset number: In “Preset” setup menu, input one preset number, press “Delete” button, you can delete this preset number.

After deleting, press “Return” button to go to “PTZ” menu. In “PTZ” menu, press “Confirm” button to save all modifications.

Please make sure the PTZ you are using can support preset function.

Sequence setup

In “PTZ” menu, press “Setup” button on the right side of “Sequence No” item, you will enter into “Sequence” setup menu:

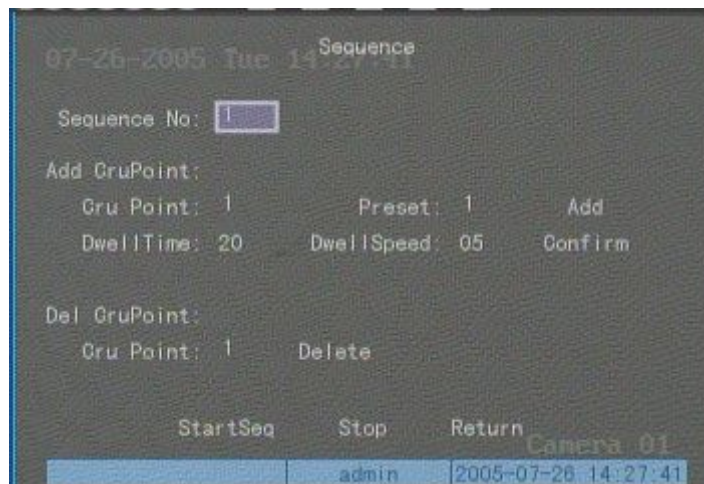

In “Sequence” setup menu, first input the sequence number. The sequence is among 1 --- 16. Each sequence is made up of cruise points, and each cruise point includes preset number, dwell time and dwell speed. Dwell time is the time staying at that preset number. Dwell speed is the speed that PTZ is moved to that preset number.

Press “Add” button to add one cruise point.

Press “Confirm” button to save the cruise point into the sequence.

After you finish setup the sequence number, press “StartSeq” to check the current sequence. Press “StopSeq” button to stop checking.

You can delete cruise points in one sequence.

After you finish sequence setup, press “Return” button to go back to “PTZ” menu. In “PTZ” menu, press “Confirm” button to save the modification.

Please make sure the PTZ you are using can support sequence function.

Cruise setup

In “PTZ” menu, press “Setup” button on the right side of “Cruise” item, you can enter into “Cruise” setup menu:

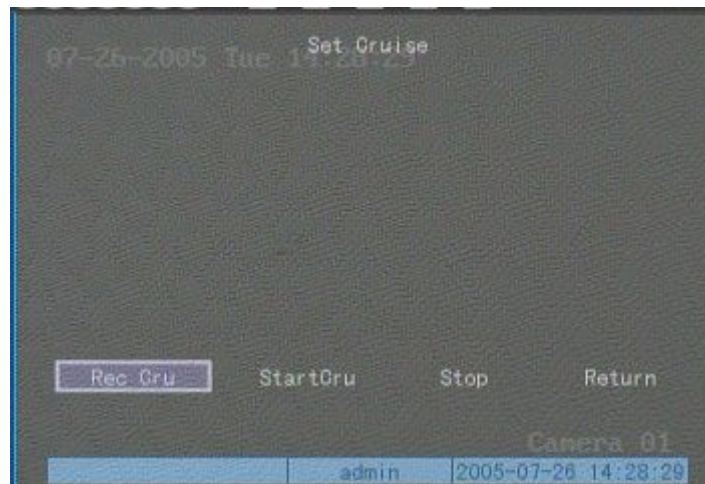

Press “RecCru” button, you will enter into “PTZ control” interface. You can start controlling PTZ with direction keys, press **【ENTER】** to save the operation track and return to “Cruise” setup menu. Press “StartCru” button to repeat the PTZ track until you press “Stop” button.

Press “Return” button back to “PTZ” menu. In “PTZ” menu, press “Confirm” button to save this cruise.

Please make sure the PTZ you are using can support cruise function.

6.16 RS232 setup

There is one RS-232 port on DVR rear panel. In main menu, move “Active Frame” to “RS232” icon and press **[ENTER]** key, you enter into “RS232” setup menu:

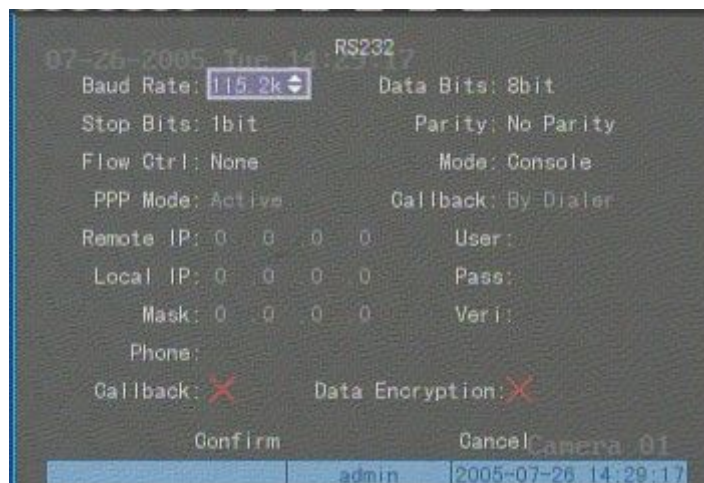

RS232 menu description

RS-232 parameters: Including baud rate, data bit, stop bit, parity, flow control, etc.

Work mode: The RS-232 can be used as “Console”, “PPP” or “Transparent Channel”.

Console: Connect with PC serial port. You can use HyperTerminal or NetTerm to control it.

PPP: Connect Modem, using PSTN to transfer video image.

Transparent channel: Connect serial devices. Remote PC can control these serial devices through network.

PPP Mode: Only used when work mode is “PPP”. There are two options: “Active” and “Passive”. “Active” means DVR will dialup through PSTN. “Active” function is not available. “Passive” means DVR will wait for dialup.

Callback mode: Only used when work mode is “PPP”. There are two options: “By Dialer” and “Preset Tel”. This function is not currently available.

Remote IP: Only used when work mode is “PPP”. This IP is defined for remote PC that will connect DVR through PSTN.

Local IP: Only used when work mode is “PPP”. This IP is defined for DVR.

Mask: Only used when work mode is “PPP”. Remote IP and Local IP are in the same sub net.

Username, password and Verify password: Only used when work mode is “PPP”. Used for

login with remote PC dialup through PSTN.

Phone: Only used when work mode is “PPP” and PPP mode is “Active”. It is the phone number of remote PC.

Callback and Data Encryption: Only used when work mode is “PPP”. This option is not currently available.

Confirm: Save parameters and return main menu.

Cancel: Abort modification and return main menu.

Example: PPP (Modem) passive dialup through PSTN

There are two Modems. One is connected to the DVR RS-232 port with DCE cable. The other is connected with PC COM port.

Setup at DVR end

Step 1: RS232 setup: Setup baud rate, data bit, stop bit, parity and flow control. They must be the same as those of modem connected with PC.



Step 2: Video setup In “Recording” menu, select the camera you want to transfer through PSTN. If you set CIF resolution, we suggest you set frame rate as 1 FPS. If you set QCIF resolution, the frame rate can be selected under 4FPS. You can adjust bit rate, resolution and frame rate according to your needs.

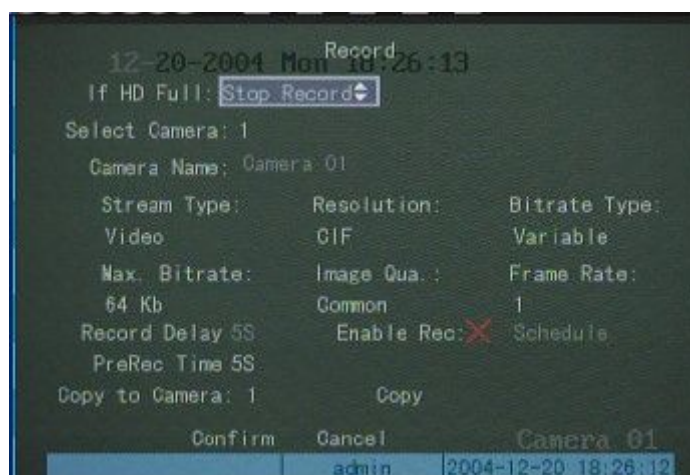

Step 3: Save setup: In “Recording” menu, press “Confirm” button to save parameters.

Step 4: Setup Modem used on DVR side: Use DCE cable to connect Modem with PC serial port. You can use HyperTerminal or NetTerm to setup modem:

AT&F ----- Retore default parameters (Generally, Modem is hard flow control)

AT&S0=1----- Set Modem as answer

ATE0 ----- Not display the input characters

ATQ1 -----Commit instruction and not display

AT&W&W1 ---- Save parameters

Step 5: Use DCE cable to connect Modem with DVR RS232 port.

Setup at PC end

Step 1: Setup Modem used on PC side. Use DCE cable to connect Modem with PC serial port. You can use HyperTerminal or NetTerm to setup modem:

AT&F ---- Retore default parameters (Generally, Modem is hard flow control)

AT&W&W1 ---- Save parameters

Step 2: Open “Network and Dial-up Connections” in control panel, then press “New Connection...”, select “Dial-up to private network” according to the guide. Select the corresponding MODEM, input the telephone number to be dialed in the next step, finish it according to the guide. At this point you will find a new program named “Dial-up Connection” in “Network and Dial-up Connections” folder.

During setup especially pay attention to:

Open the properties of the new-established dialup program, select “Advanced”(custom settings) in security option, press setup, set it in the popup dialogue box that is “Advanced Security Settings” as follows:

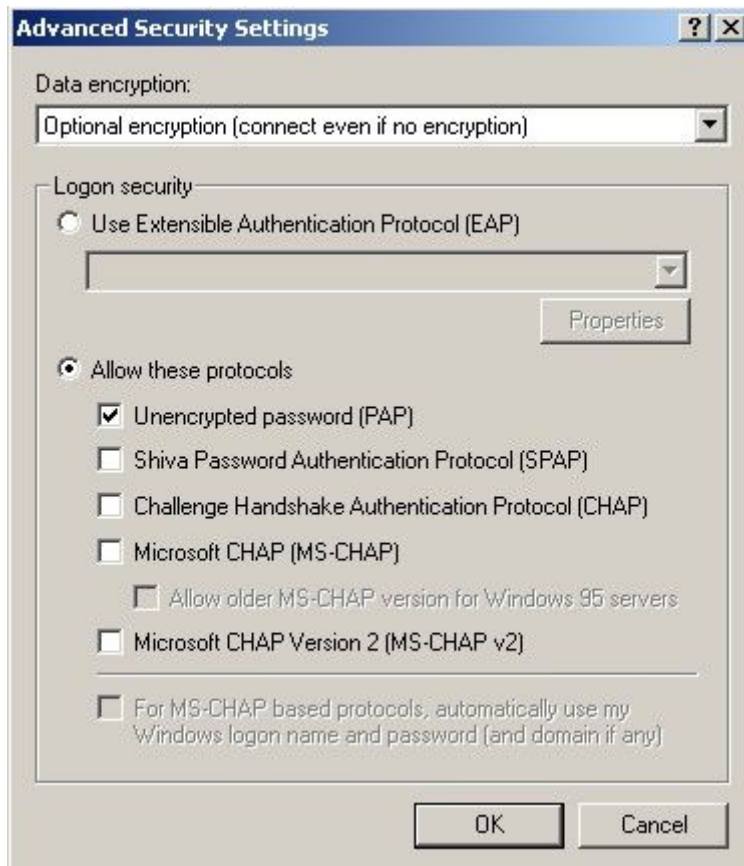
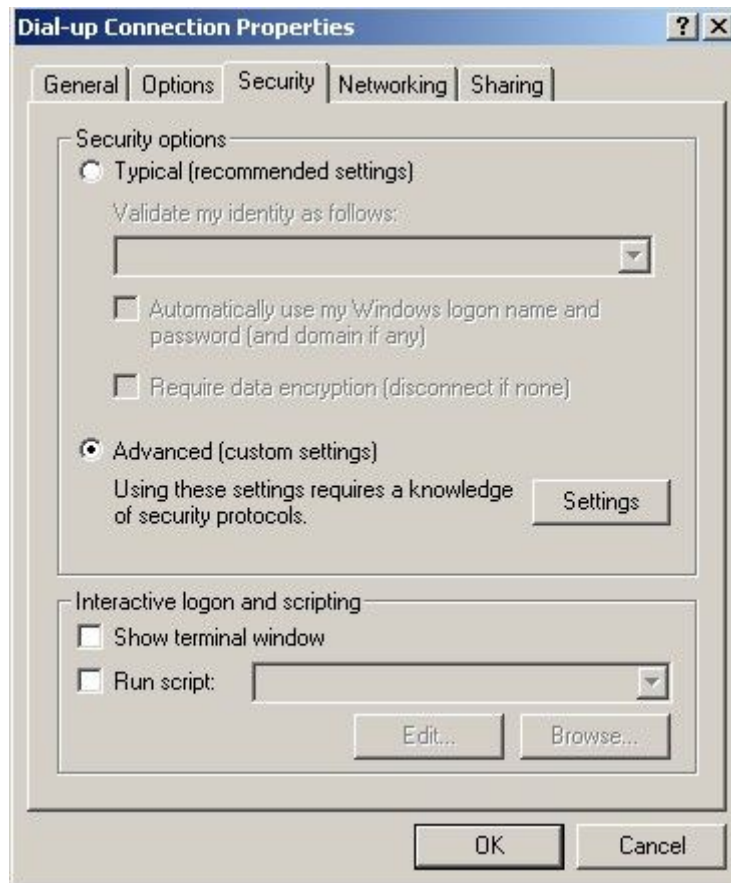

Step 3: Establish the dialup connection

Select the Modem connected with PC just like the dialup network connection, input the telephone number connected with DVR's modem. Input the username, password. They must be the same as in DVR PPP setup.

Step 4: During the dialup connection, it will give the message: "verification of username and password", after successful verification; the message will be given: "on process of register in PC". The process is the same as a common dialup connection.

Step 5: After successful dialup, network will designate the "remote IP" address to PC, e.g. the set 192.1.0.1. User can Ping-link the assigned IP address through Ping command, and can Ping-link DVR. Please refer to the following picture.



```
C:\>ipconfig

Windows 2000 IP Configuration

PPP adapter

    Connection-specific DNS Suffix . :
    IP Address. . . . . : 192.1.0.1
    Subnet Mask . . . . . : 255.255.255.255
    Default Gateway . . . . . : 192.1.0.1

C:\>ping 192.1.0.2

Pinging 192.1.0.2 with 32 bytes of data:

Reply from 192.1.0.2: bytes=32 time=130ms TTL=64
Reply from 192.1.0.2: bytes=32 time=130ms TTL=64
Reply from 192.1.0.2: bytes=32 time=130ms TTL=64
Reply from 192.1.0.2: bytes=32 time=130ms TTL=64

Ping statistics for 192.1.0.2:
    Packets: Sent = 4, Received = 4, Lost = 0 (0% loss),
    Approximate round trip times in milli-seconds:
        Minimum = 130ms, Maximum = 130ms, Average = 130ms
```

Step 6: You can preview the image of 192.1.0.2 by using client-end software.

6.17 Exceptions

The exceptions that can be handled at present include: hard disk full, hard disk error, illegal access, IP address conflict, network failure, and NTSC/PAL difference.

Enter into “Exceptions” menu:

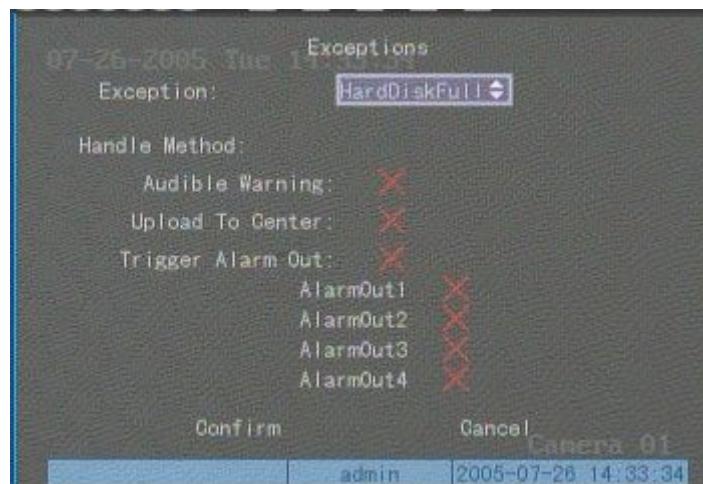

Including the following handle methods:

Audible Warning: DVR beep warning.

Upload to Center: Send exception information to center host PC.

Trigger Alarm Output: trigger local relay output.

You can select more than one handle method.

After you finish setup, press “Confirm” button to save parameters. Press “Cancel” button or **[ESC]** key to abort.

6.18 Transaction Information

The DVR can actively obtain or passively receive the credit card number from ATM machines linked through network or serial port, and credit card number can be overlaid on live video, recorded and playback. The following description indicates how to carry out relevant parameter setting according to different links to ATM machine.

In “Transaction Information” menu, there are 4 kinds of text capture solutions:

1. Network Sniff: Obtain the transaction information such as credit card number actively through network.

The network connection is as follows:

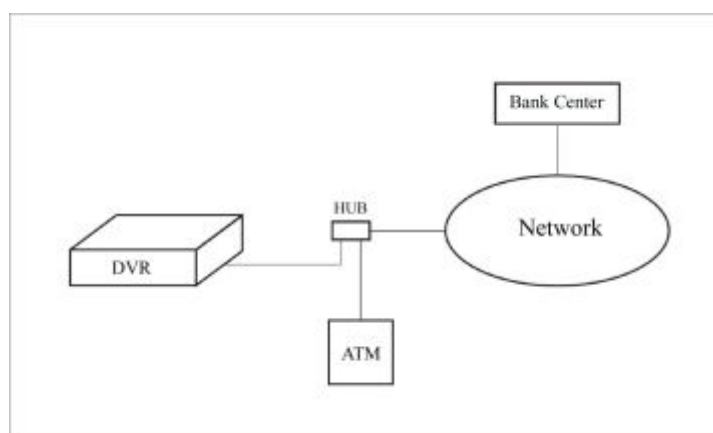

The corresponding setup menu is as follows:

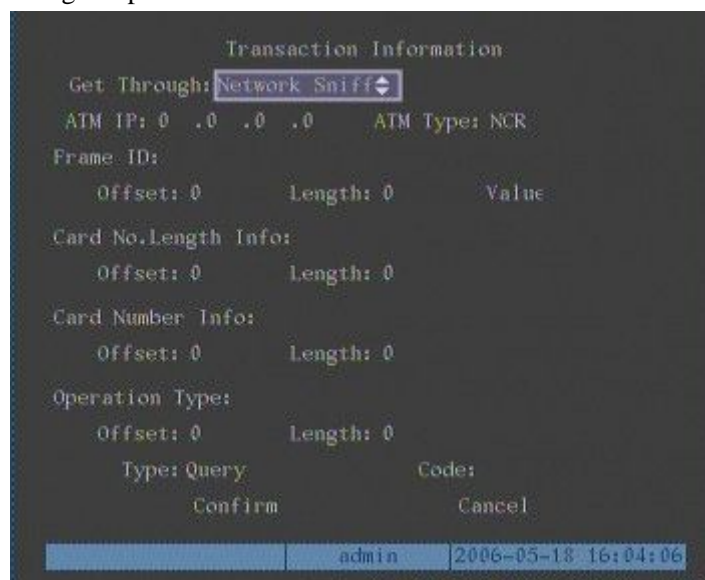

You need to setup the following information:

IP address of ATM machine

Type of ATM machine

Start & end position, length and the content of data message

Start & end position and length of credit card number

Start & end position and length of transaction type

Transaction type and code

When the ATM machine is sending transaction information to bank center, DVR will capture the data package through network, and analyse the data according to the format. Then DVR will overlay the corresponding text on live video.

2. Network receive: DVR receives data sent by ATM machine through network.

You only need to setup DVR listen port. The default port value is 10000.

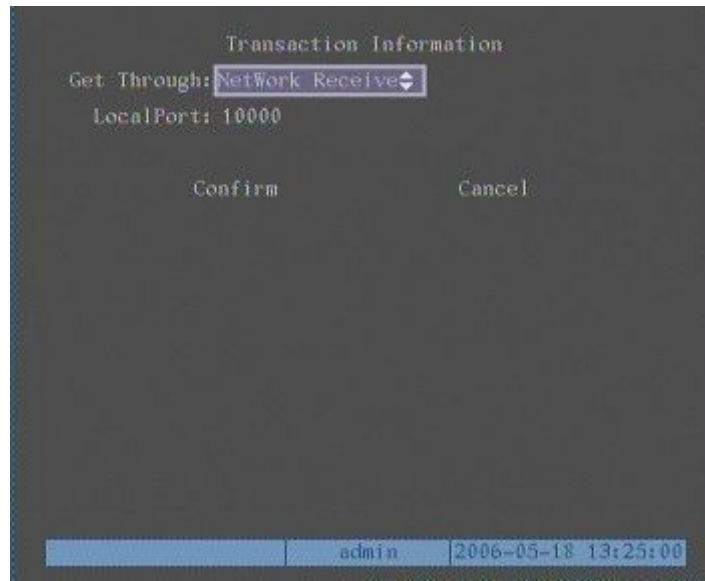

In this case, you must develop the software that is run in the ATM machine based on Hikvision protocol. The software will send the transaction information directly to the DVR. DVR will receive, analyse and overlay the text on live video.

3. Receive data sent by ATM through serial port

The connection is following:

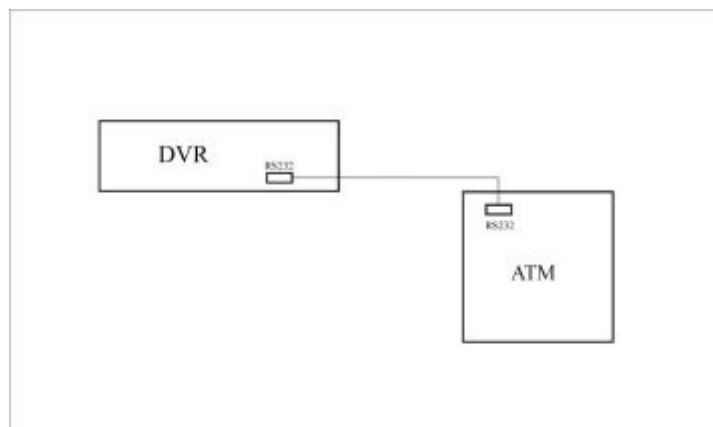

The corresponding setup menu is following:

You only need to setup ATM machine type.

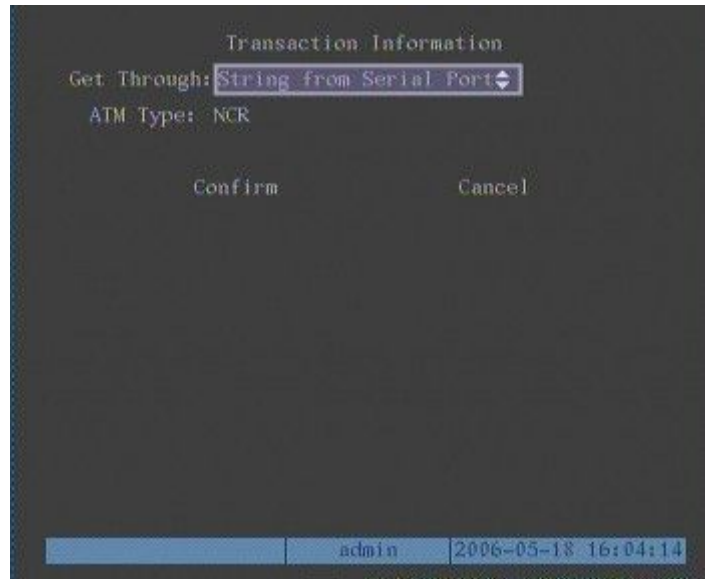

In the case, you must set the RS-232 of DVR as transparent channel mode as follows:



A software must be run in the ATM machine, and send the credit card number, transaction code to DVR through RS-232 port.

Please provide detail ATM machine communication protocol for actual projects.

4. Receive the command sent by ATM through serial port

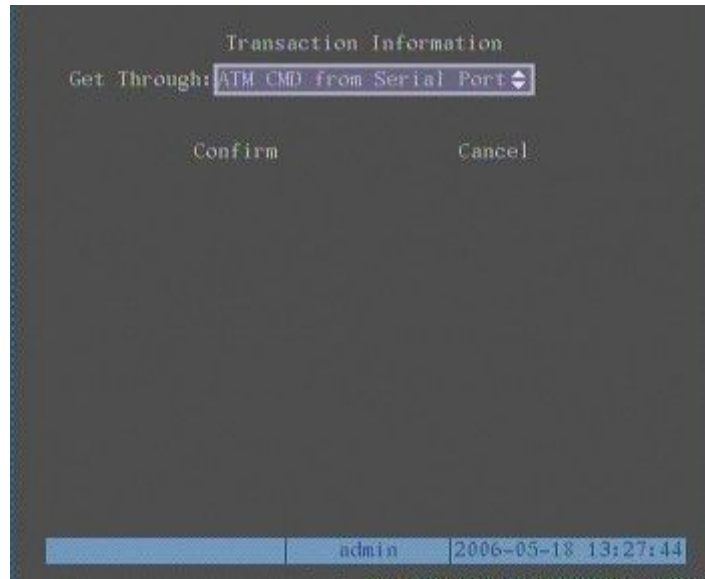

In this case, you must set the RS-232 of DVR as transparent channel mode as follows:



Also, a software must be run in ATM machine, and send command to DVR through RS-232 port based on Hikvision communication protocol.

Chapter 7 Utilities

There are many tools in “Utilities” menu. Including “SavePara”, “RestorePara”, “Upgrade”, “Hard Disk”, “Stop Alarm Out”, “Reboot”, “Power Off”, “View Log” and “System Info”.

Enter into “Utilities” menu:



7.1 Save Parameters

Save factory default parameters into FLASH memory. You can reboot DVR to make them effective.

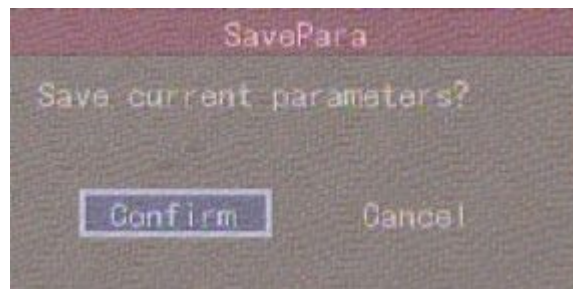

7.2 Restore Parameters

Restore factory parameters for DVR. The IP address, gateway and port number will not be changed back to defaults.

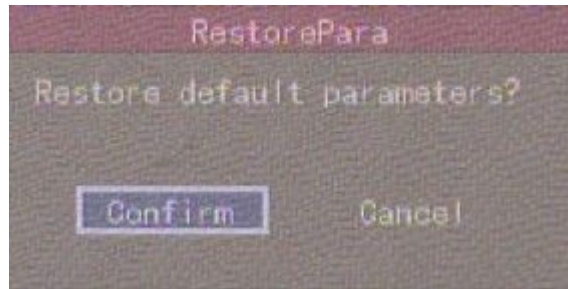

7.3 Upgrade

You can use this function to upgrade the firmware.

Press "Upgrade" icon, in the pop-up dialog, you can select either "FTP" or "USB" upgrade mode.

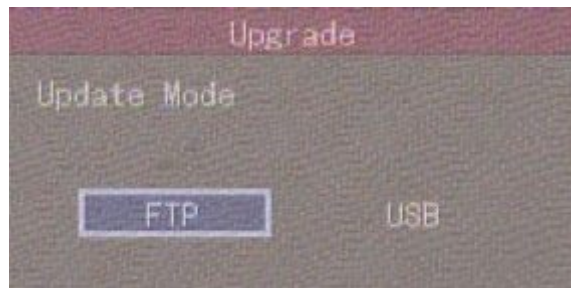

If you select "FTP" mode, you will enter into "FTP Upgrade" menu:

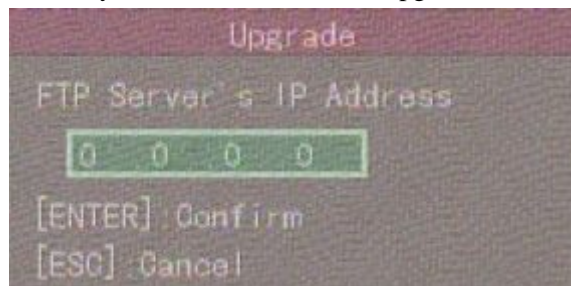

Input the ftp server IP and press **[ENTER]** key. DVR will connect with FTP server through network and download the firmware file.

If you select "USB" mode, please make sure you connect one USB flash memory to USB port on the DVR and that the firmware file is in it's root directory.

Reboot after successfully upgrading, the system will use the new firmware.

7.4 Hard Disk Management



Check HDD work status

Capacity, Free space, Stand by or not, Normal status or not.

Format HDD

Before formatting stop all recording. After formatting, you must reboot DVR, otherwise DVR will not work normally.

7.5 Clear Alarm Out

Clear the alarm output manually.

7.6 Reboot

Reboot DVR.

7.7 Power Off

Shut down DVR.

7.8 View Log

To view the log recorded in DVR HDD.

In "Utilities" menu, press "View Log" to enter into "Log" menu:

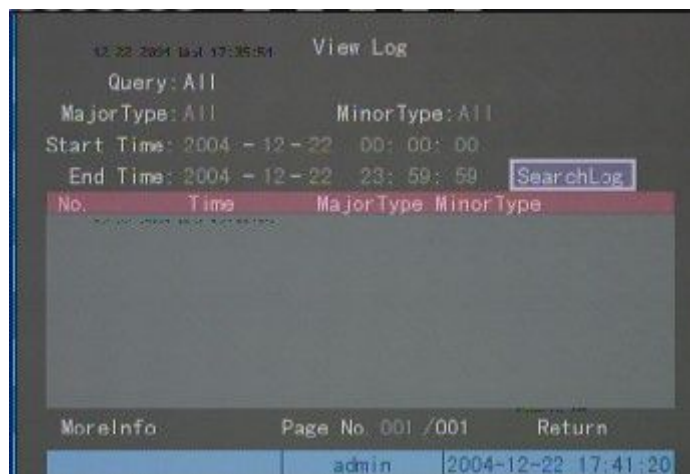

If you want to view the log based on default option, just press **[ENTER]** key. DVR will list all matched information. Also you can select options to search (By Type, By Date, By Type&Date).

By Type

To view log information of the assigned type.

Type is divided into “Major type” and “Minor type”. Major type includes operation, alarm, exception and all.

For operation major type, there are many minor types, including Power On, Shut Down, Abnormal Shut, Panel Login, Panel Logout, Panel Config, Panel File Play, Panel Time Play, Local Start Record, Local Stop Record, Panel PTZ, Panel Preview, Panel Set Time, Local Upgrade, Net Login, Net Logout, Net Start Record, Net Stop Record, Net Start Transparent Channel, Net Stop Transparent Channel, Net Get Parameter, Net Config, Net get Status, Net Alert On, Net Alert Off, Net Reboot, BiComStart (Start Voice Talk), BiComStop (Stop Voice Talk), Net Upgrade, Net File Play, Net Time Play, Net PTZ.

For alarm major type, the minor type includes: External Alarm In, External Alarm Out, Motion Detect Start, Motion Detect Stop, View Tamper Start, View Tamper Stop.

For exception major type, the minor type includes: Video Signal Loss, Illegal Access, Hard Disk Error, Hard Disk Full, IP Conflict, DCD Lost.

For example: The steps of viewing alarm log.

Step 1: For “Query” item, select “By Type” to activate “Major Type” and “Minor Type” items.

Step 2: For “Major Type” option, select “Alarm” option. For “Minor Type” option, select one of following options: All, External Alarm In, External Alarm Out, Motion Detect Start, Motion Detect Stop, View Tamper Start, View Tamper Stop .

Step 3: Move “Active Frame” to “Search Log” button, press **【ENTER】** key to start searching.

Step 4: When searching is finished, DVR will list all matched alarm information. In the list box, the information includes: Index, Occur Time, Major Type, Minor Type, Panel User, Net User, Host Address, Para. Type, Channel No, HDD No, Alarm In and Alarm Out. You can press “More Info” button for more information, also select page number to view more information.

Step 5: Press “Return” button back to “Utilities” menu.

By Time

View the log during one time period.

Step 1: Select “By Time” for “Query” option to activate “Start Time” and “Stop Time” items.

Step 2: Input start time and stop time.

Step 3: Move “Active Frame” to “Search Log” button and press **【ENTER】** key to start searching.

Step 4: After finishing search the DVR will list the matched log information.

Step 5: Press “Return” button to go back to “Utilities” menu.

By Type&Date

View one kind of log in the assigned time period.

Step 1: Select “By Type&Time” for “Query” option to activate “Major Type”, “Minor Type” “Start Time” and “Stop Time” items.

Step 2: Select “Operation” for major type and select one option for minor type.

Step 3: Input start time and stop time.

Step 4: Move “Active Frame” to “Search Log” button and press **【ENTER】** key to start searching.

Step 5: After finishing search DVR will list the matched log information.

Step 6: Press “Return” button to go back to “Utilities” menu.

7.9 System Information

Press “System Info” icon in “Utilities” menu, you can get DVR system information:



Chapter 8 Firmware Upgrade

The DVR firmware is stored in FLASH ROM. You can use DVR upgrade function to write the firmware file (digicap) into the FLASH ROM.

There are two cases that you need to upgrade DVR firmware. One is to update old firmware. The other is when the code in DVR FLASH has crashed.

Note: Make sure that the DVR and the firmware are compatible before the upgrade.

8.1 FTP Server Setup

You can download FTP server software through internet. Here we use wftpd32.exe as the example:

1. Run wftpd32.exe (FTP server software).

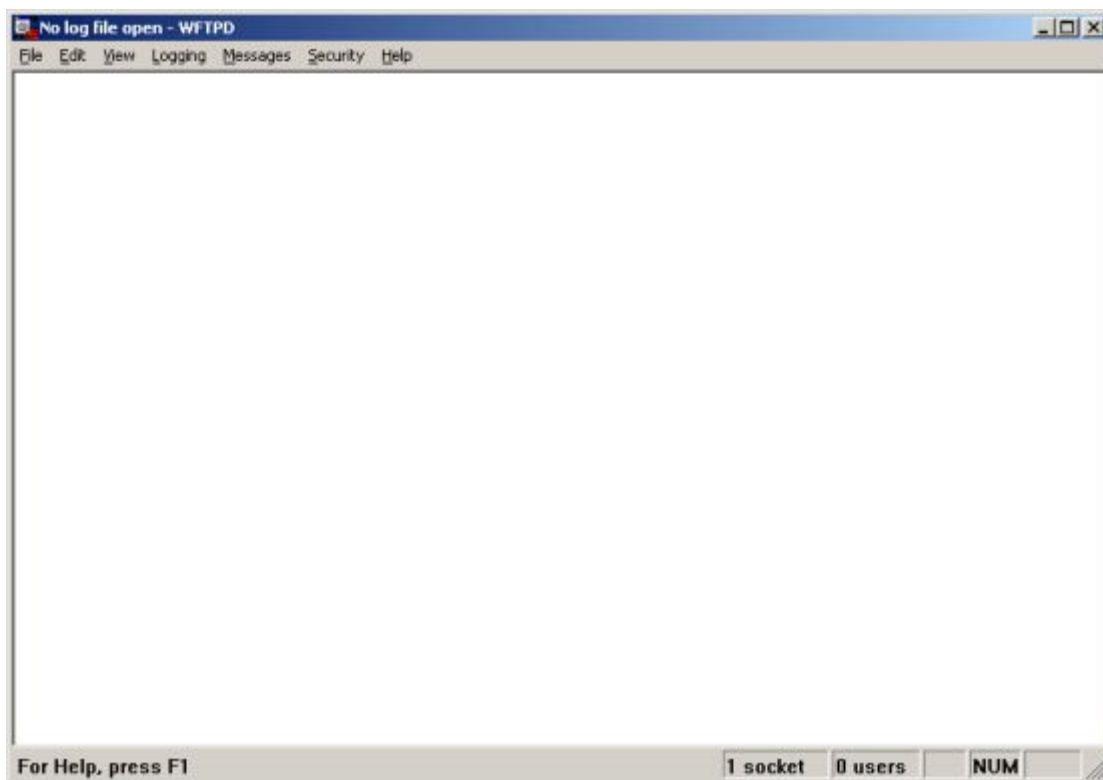

2. Select "Logging" in the menu ,choose Log Options in the sub menu, and give the choice as follows:

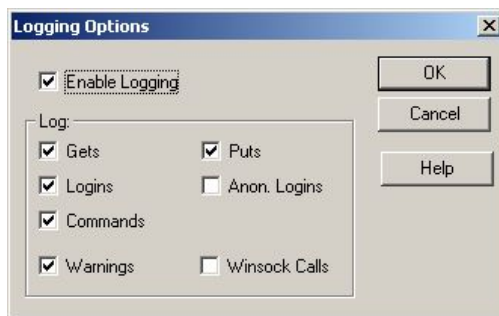

3. Select “Users/rights” under “Security” menu item. The following dialog box will pop-up.



4. Create new user. Click “new user’. New user dialog pops up. Input user name “target”. Click “OK”.



5. In the password dialog box, also input password “target” in “New Password” and “Verify Password” edit box. Click “OK” to save and exit the dialog box.

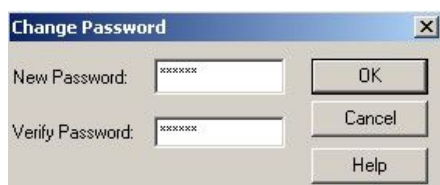

6. In the “User/Rights Security” Dialog, select “User Name” as “target”. In “Home Directory” edit box, input the path where the firmware file (digicap) is placed. Then press “Done” to exit.

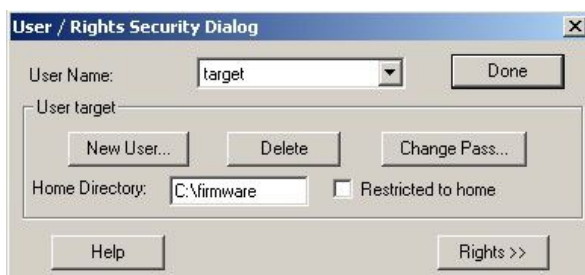

7. Next time, you do not need to setup again, just double click and open “wftpd32.exe” to upgrade the DVR/DVS firmware.

8.2 Upgrade Mode

1. Use client software to upgrade the firmware file. You do not need to use ftp server software. Please refer to the client software user manual for detailed information.
2. Use “FTP” function of “Upgrade” sub menu in “Utilities” menu. You need one host PC to run FTP server software and place firmware file (digicap), and make sure DVR and PC are in the same sub net.
3. Use “USB” function of “Upgrade” sub menu in “Utilities” menu. Please make sure the firmware file (digicap) is placed under root directory of USB flash memory.
4. After you reboot DVR, if you can hear the startup sound, but can not see startup picture, you can input shell commands under HyperTerminal. You need one host PC to run FTP server and HyperTerminal software, and make sure DVR and host PC are in the same sub net. Please use DTE cable to connect DVR will host PC.

Step 1: Setup and run HyperTerminal

The parameters are: Baud rate: 115200bps, Data bit: 8 bits, Stop bit: 1 bit,

Parity: No, Flow ctrl: None.

Step 2: Press "ctrl" and "u" keys of the PC keyboard. Do not release them.

Step 3: Switch the power supply of DVR off and on. In the HyperTerminal, the following sentence appears: **Please input [u/U] or [ESC] key**, Release "ctrl" and "u" keys.

Step 4: Press “u” key. In the message line of “**IP address of NET DVR**”, input any one IP, just make sure DVR IP and FTP server IP are in the same sub net.

Step 5: In the message line of “**IP address of the FTP server**”, input the FTP server IP.

Step 6: In the message line of “**Confirm? (y/n)**”, press “y”. DVR will connect with that FTP server, and download the firmware file (digicap) through the network. Please make sure FTP server and firmware file are setup and run correctly. After upgrade finishes, press any key to reboot DVR.

Appendix A HDD Capacity Calculation

How to calculate total capacity needed by the DVR according to video recording (video recording type and video file storage time).

Step 1: According to Formula (1) to calculate storage capacity q_i that is the capacity of each channel needed for every hour, unit Mbyte.

$$q_i = d_i \div 8 \times 3600 \div 1024 \quad (1)$$

In the formula: d_i means the bit rate, unit Kbit/s

Step 2: After video time requirement is confirmed, according to Formula (2) to calculate the storage capacity m_i , which is storage of each channel needed in Mbytes.

$$m_i = q_i \times h_i \times D_i \quad (2)$$

In the formula:

h_i means the recording time for each day (hour)

D_i means number of days for which the video shall be kept

Step 3: According to Formula (3) to calculate total capacity (accumulation) q_T that is needed for all channels in the DVR during **scheduled video recording**.

$$q_T = \sum_{i=1}^c m_i \quad (3)$$

In the formula: c means total number of channels in the DVR

Step 4: According to Formula (4) to calculate total capacity (accumulation) q_T that is needed for all channels in DVR during **alarm video recording (including motion detection)**.

$$q_T = \sum_{i=1}^c m_i \times a\% \quad (4)$$

In the formula : $a\%$ means alarm occurrence rate

Appendix B DVR Connect Cable

Definition

1 How to make a RS-485 connect cable

Material and tool

One twist cable (8 pins), one standard RJ45 connector and one special tool for RJ45.

RJ45 introduction

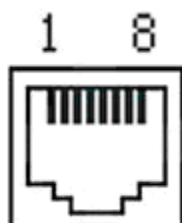

Pin definition

Make the connect cable according the following;. The left point of RJ45 head, 1st and 2nd cables are the anode and cathode line for sending, 3rd and 4th cables are the anode and cathode line for receiving, 7 is the shared grounding line:

RXD+	3	←
RXD-	4	←
TXD+	1	→
TXD-	2	→
GND	7	

Pin definition for Standard RS-485 serial port RJ45 plug-in

2 How to make a UTP network connect cable

Material and tool

One twist cable (8 pin, the length can be whatever is needed up to 100m), 2 standard RJ45 heads, one tool for RJ45.

Suggestion: have a network cable test tool to test each cable made.

Pin definition

To make the network cable according to your actual needs, there are two options:

(1) Use the following method to make the network cable when DVR is connected with network hub or switch.

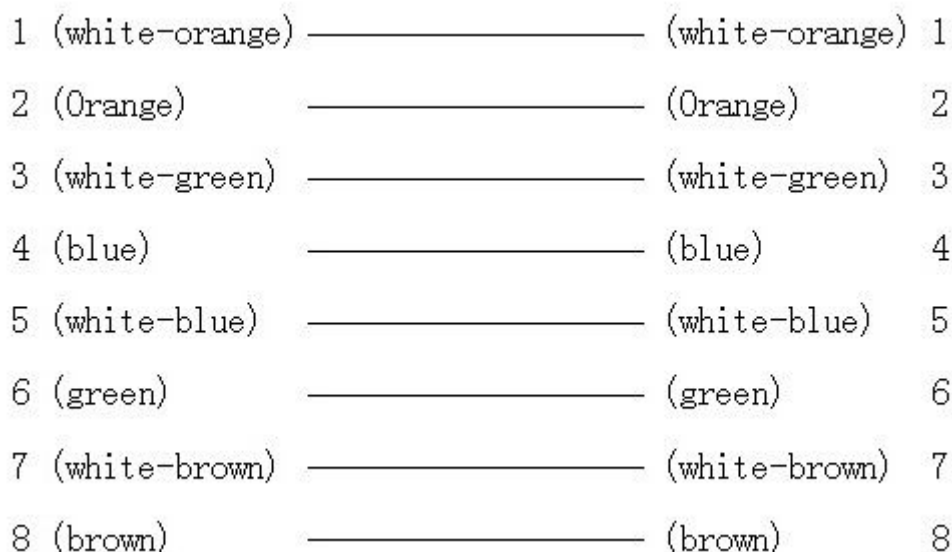

The corresponding relationship of the direct cable

(2) Use the following method to make the cross network cable when DVR is directly connected with client-end PC.

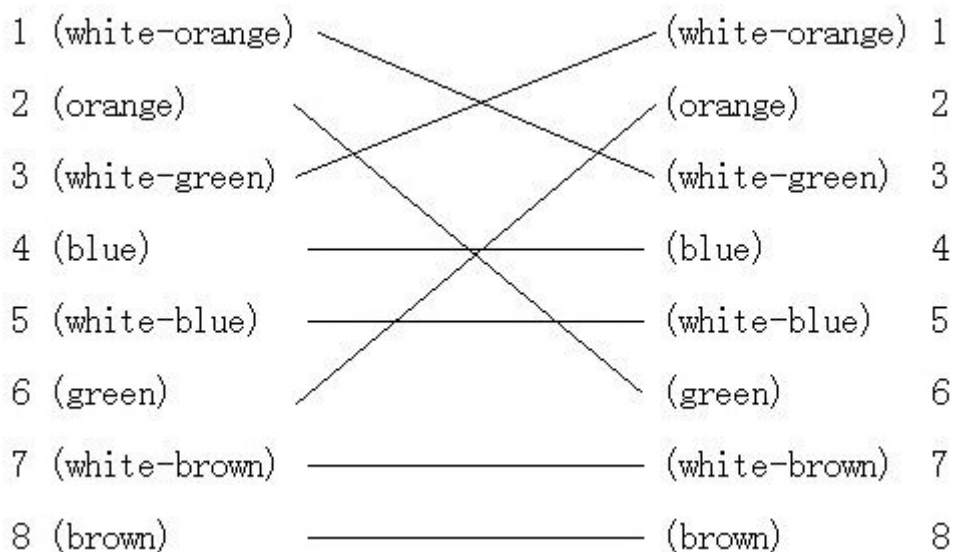

The corresponding relationship of cross cable

3 How to make a RS-232 connect cable

Material and tool

One twisted cable (8 pins), one standard RJ45 head, one or more DB25 or DB9 plug-ins, a tool for RJ45, one electric iron, and some soldering tin.

Pin definition

Make the RJ45 according to the following pin definition; I means DVR input, O means DVR output.

Pin index	Name	I/O	Description
1	DCD	I	Carrier Detect
2	RxD	I	Receive Data
3	TxD	O	Transfer Data
4	CTS	I	Clear Data
5	RTS	O	Request to Send
6	DTR	O	Terminal Device Ready
7	GND		Ground
8	Null	—	—

According to demand, the following three situations are considered to make the serial port plug-in according to the corresponding relationship of the pin definition.

(1) When the serial port of the DVR is connected with the DTE device with DB25 plug-in (terminal like computer, annunciator, door access etc), the corresponding relationship is as follows:

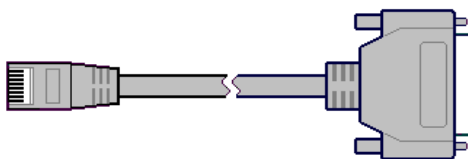

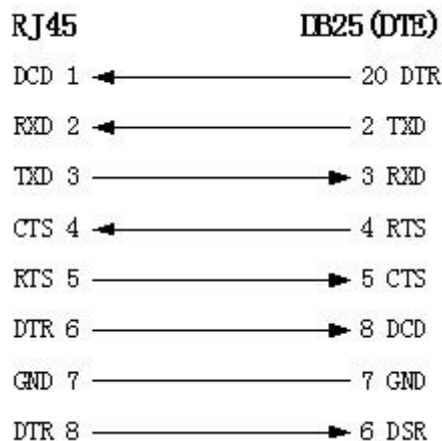

Connection for RJ45 and DB25 (DTE)

(2) When the serial port of the DVR is connected with DTE device with DB9 plug-in, the corresponding relationship is as follows:

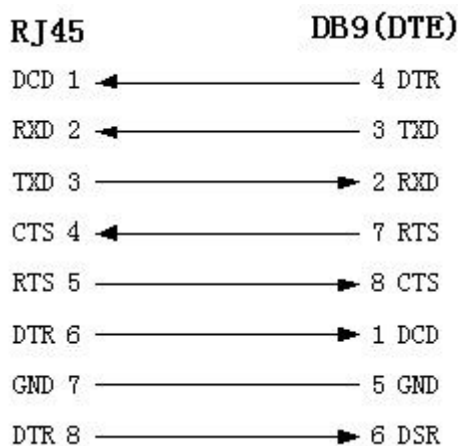

Connection for RJ45 and DB9

25-pin to 9-pin converter internal connection is defined as follows:

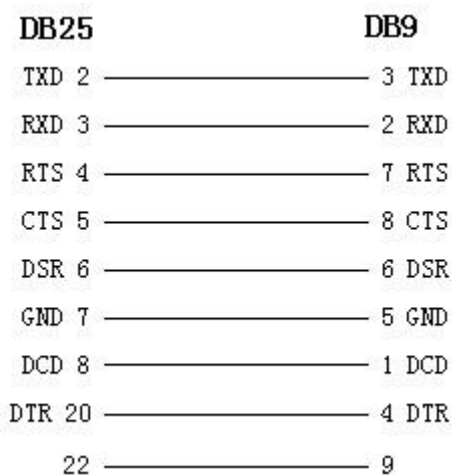

Connection for DB25 and DB9

(3) When the serial port of DVR is connected with DCE device (like MODEM), one end

of the cable is 8-pin RJ45 plug-in, the other end is DB25 pin plug-in, the corresponding relationship is as following:

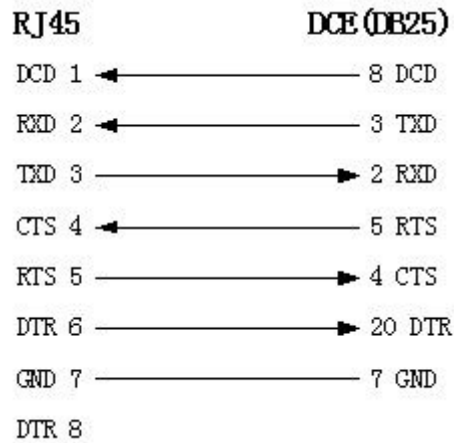

Connection for RJ45 and DB25 (DCE)

Appendix C Specifications

Model name	QSD42208	QSC26408	QSC26416	
Video compression	H.264			
Preview resolution	4CIF real time (PAL: 704*576, NTSC: 704*480)			
Playback resolution	(QSD422408 also has 2CIF) CIF/QCIF real time			
Video input	8	8	16	
	BNC (1.0Vp-p, 75Ω)			
Main video output	1 channel, BNC (1.0Vp-p, 75Ω)			
Aux video output	--	1 channel, BNC (1.0Vp-p, 75Ω)		
Frame rate	PAL: 1/16—25FPS, NTSC: 1/16—30FPS			
Stream type	Video/ Video&Audio (No audio on QSD42208)			
Max bit rate	32Kbps--2Mbps, self-define			
Audio input	0	8	16	
	BNC (2.0Vp-p, 1kΩ)			
Main audio output	(None on QSD42208) 1 channel, BNC (Linear Electrical Level, 600Ω)			
Aux audio output	--	1 channel, BNC (Linear Electrical Level, 600Ω)		
Audio compression	(No audio on QSD42208) OggVorbis, 16Kbps			
Voice talk	1 channel, BNC (Linear Electrical Level, 1KΩ)			
Communication interface	1 RJ45 10M/100M Self-adaptive Ethernet Interface 1 RJ45 RS232 Port			
RS-485 Port	1 Port (T+, T-, R+, R-)			
Keyboard interface	1 Port (D+, D-)			
SATA interface	8	8	8	
USB interface	1 USB interface, USB1.1, can support USB flash memory, USB HDD, USB CD-R/W, USB DVD or USB mouse.			
VGA interface	1 VGA interface, support resolution: 800×600/60Hz, 800×600/75Hz, 1024×768/60Hz			
External alarm in	16	16	16	
Relay output	4	4	4	
Power supply	100~240VAC, 6.3A, 50~60Hz			
Power consumption	20 - 42W (without HDD and CD-R/W)			

Working temperature	14 F—131 F
Working humidity	10%--90%
Size	19" Standard (17.25(W)*18(D)*3.75(H))
Weight	≤18 Lbs (without HDD and CD-R/W)

	QSF2648008/QSF2648016 (Enterprise Series)
Video compression	H.264
Preview resolution	4CIF real time (PAL: 704*576, NTSC: 704*480)
Playback resolution	4CIF/DCIF/2CIF/CIF/QCIF real time
Video input	8/16 channels BNC (1.0Vp-p, 75Ω)
Main video output	1 channel, BNC (1.0Vp-p, 75Ω)
Aux video output	1 channel, BNC (1.0Vp-p, 75Ω)
Frame rate	PAL: 1/16—25FPS, NTSC: 1/16—30FPS
Stream type	Video/ Video&Audio
Max bit rate	32Kbps--2Mbps, self-define
Audio input	8/16 channels BNC (2.0Vp-p, 1kΩ)
Main audio output	1 channel, BNC (Linear Electrical Level, 600Ω)
Aux audio output	1 channel, BNC (Linear Electrical Level, 600Ω)
Audio compression	OggVorbis, 16Kbps
Voice talk	1 channel, BNC (Linear Electrical Level, 1KΩ)
Communication interface	1 RJ45 10M/100M Self-adaptive Ethernet Interface 1 RJ45 RS232 Port
RS-485 Port	1 Port (T+, T-, R+, R-)
Keyboard interface	1 Port (D+, D-)
SATA interface	8 SATA interfaces, max support 8 SATA HDD. Each HDD can max support 2000GB
USB interface	1 USB interface, USB1.1, can support USB flash memory, USB HDD, USB CD-R/W, USB DVD or USB mouse.
VGA interface	1 VGA interface, support resolution: 800×600/60Hz, 800×600/75Hz,

	1024×768/60Hz
External alarm in	16
Relay output	4
Power supply	100~240VAC, 6.3A, 50~60Hz
Power consumption	20 - 42W (without HDD and CD-R/W)
Working temperature	14 F—131 F
Working humidity	10%--90%
Size	19" Standard (17.25(W)*18(D)*3.75(H))
Weight	≤18 Lbs (without HDD and CD-R/W)

PAL: 176*144(QCIF), 352*288(CIF), 704*288(2CIF), 528*384(DCIF), 704*576(4CIF);
 NTSC: 176*120(QCIF), 352*240(CIF), 704*240(2CIF), 528*320(DCIF), 704*480(4CIF).

Appendix D Quick Search Function Table

Type	Name	Description	Index
Safety function	User management	Create and delete users. System has one default administrator. The administrator can create 15 users and define their rights.	5.2
	Password Management	Modify password.	4.3&5.1
HDD recording	HDD management	Format HDD, HDD information.	6.4
	Recording mode	Manual record, All time record, Motion detection record, Alarm record, Motion&Alarm record, Motion Alarm record.	5.12
	Recording para.	Bit rate, Frame rate, Image quality etc	5.12
	Playback	Playback by time, Playback by file. Fast, Slow, Pause, Frame by frame. 2-ch synchronized.	4.6
	Backup	Backup record files and video clips.	4.7
Local monitoring	Preview mode	Monitor and VGA display. 1 screen/4 screen/9 screen/16 screen preview mode. Auto switch or manual switch.	5.11
	PTZ control	Control pan, tilt, zoom, focus and iris. Setup and adjust preset, sequence and cruise.	4.4
	Motion detection	Motion detection area, sensitivity and response policy setup.	5.10
	Alarm input	Alarm input response policy, schedule setup.	5.13
	Relay output	Alarm output parameters setup.	5.13
	Mask	Sensitive mask area setup.	5.7
	View tampering	Camera spiteful block setup.	5.8
	Exceptions	Exception response, such as HDD error, HDD full, illegal access, etc.	5.17
	Camera status	Recording, video loss status display.	4.2
Network	ASDL	Using PPPoE dialup function, support DNS.	5.14
	Preview	TCP, UDP, RTP, Multicast.	*
	Control	Control DVR through network.	*
	Alarm	Send alarm information to host PC through network.	5.14
	PTZ control	Remotely control PTZ.	*
	Remote setup	Remotely setup DVR parameters.	*

	Remote record	Remotely record real time stream.	*
	Remote playback	Remotely playback the recorded files in DVR	*
	Download	Download recorded files in DVR.	*
	Remote upgrade	Remotely upgrade firmware.	*
	Transparent channel	Remotely control serial device connected with serial port of DVR.	5.16
	Web	Using IE or Client software to access DVR	*
	PSTN	Access DVR through PSTN.	5.16
Utilities	OSD	OSD setup	5.5
	LOGO	Logo setup	5.5
	View log	View log	6.8
	Voice talk	Two way voice talk or one way voice broadcast	*

【*Note】 The network SDK and client demo source code are available on request.

Appendix E Troubleshooting

Failure	Possible reasons
After plugging in power, turning on the power switch, "POWER" light in front Panel does not turn on, and fan does not work.	<ol style="list-style-type: none"> 1) Power cable is damaged. 2) Power supply is damaged.
After plugging in power, turning on the power switch, "POWER" light in front panel turn to green while fan does not work.	<ol style="list-style-type: none"> 1) Front panel cable is damaged. 2) Fan is broken.
After plugging in power, turning on switch, "POWER" light turn to green, the indicator lights in the panel turn on at the same time, but fan does not work.	The ATX plug in main board is not plugged in well.
DVR continuously reboots after start up, and makes a sound like "di" every 10 seconds.	<ol style="list-style-type: none"> 1) Used wrong firmware upgrade 2) Compression board has problems. 3) Main board has problems.
There are no images on the monitor connected with VOUT after DVR is started.	<ol style="list-style-type: none"> 1) The cable connected with the monitor is damaged. 2) Real board of DVR has problems. 3) Main board of DVR has problems.
Cannot find the hard disk in reboot process.	<ol style="list-style-type: none"> 1) Hard disk cable is damaged. 2) The power cable of hard disk is not connected. 3) Hard disk has problems.
No reponse in HyperTerminal interface.	<ol style="list-style-type: none"> 1) Baud rate does not match. 2) RS-232 cable is damaged. 3) Serial port of PC is damaged. 4) RS-232 port of DVR is damaged.
DVR can not control PTZ through RS-485 port.	<ol style="list-style-type: none"> 1) RS-485 cable is not connected correctly or damaged. 2) PTZ parameters error. 3) RS-485 port of DVR is damaged.
Client software can not view DVR live image.	<ol style="list-style-type: none"> 1) Network error. 2) Wrong connectinon settings

	on DVR (wrong IP, port number, username or password, ect). 3) Old player SDK (playm4.dll)
--	--

Notes:

- 1) Place the DVR in well ventilated space so that it operates within the allowed range of temperature and humidity as in specifications.
- 2) If the circuit board gets wet, dust on circuit board can cause a short circuit. The circuit board, plug and socket, housing fan and housing should be cleaned by brushing.

Appendix F Product Service

Thank you for choosing our products.

All of our products users can enjoy a conditional free warranty repair service for hardware within 12 months starting from purchase date, and a free exchange service within one month (valid for manufacturing defects). Permanent upgrading service is provided for the software.

Liability Exclusions:

Any product malfunction, abnormalities in operation or damage caused by following reasons are not within the free service scope of our company. Please select payable service.

(1) Equipment damage caused by improper operation

(2) Improper environment and conditions in/on which the equipment operates, e.g., improper power, environment temperature, humidity and lightening strike etc. that cause equipment damage.

(3) Damage caused by acts of nature: earthquake and fire etc.

(4) Equipment damage caused by the maintenance of personnel not authorized by our company.

(5) Product sold over 12 months ago.

In order to provide various services to you, please complete registration procedure after you purchase the product. Cut off or copy User's Information Card and fax or mail it to us after the card is filled in.

Address: Q-See Products

8015 E. Crystal Dr

Anaheim, CA 92807

Fax: 714-998-3509

Appendix G Customer Information Card

User's Name		M
	r./Mrs.	
Company Name		
Post Address		
Postcode		
Phone Number		
E-mail		
Model Number of Product		
Serial Number of Product		
Purchase Date		
Distributor		

Suggestions:

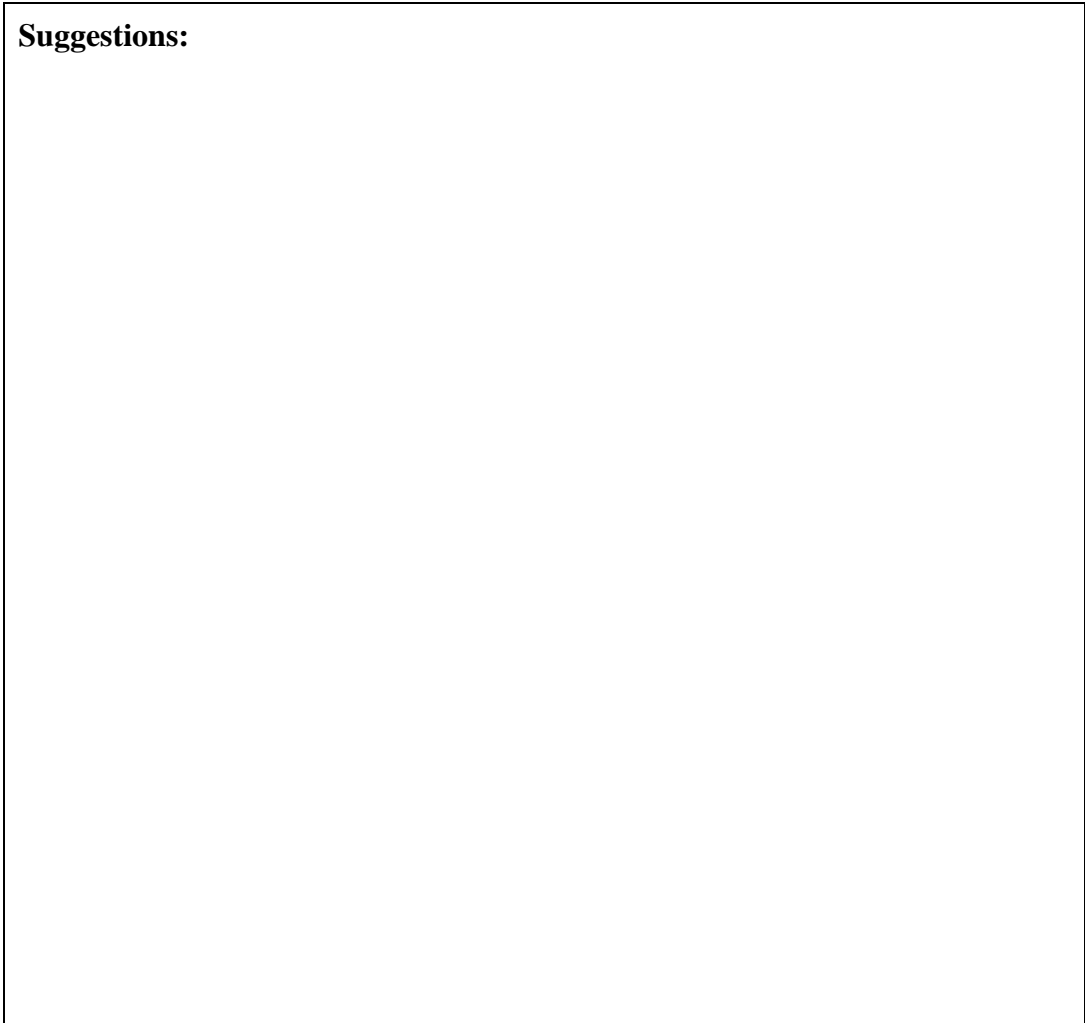

Free Manuals Download Website

<http://myh66.com>

<http://usermanuals.us>

<http://www.somanuals.com>

<http://www.4manuals.cc>

<http://www.manual-lib.com>

<http://www.404manual.com>

<http://www.luxmanual.com>

<http://aubethermostatmanual.com>

Golf course search by state

<http://golfingnear.com>

Email search by domain

<http://emailbydomain.com>

Auto manuals search

<http://auto.somanuals.com>

TV manuals search

<http://tv.somanuals.com>