



# QSD6204 User's Manual



## Contact US:

### Q-see Products

8015 E. Crystal Dr  
Anaheim, CA 92807

### Website:

<http://www.q-see.com>

### Customer Service:

Phone: 877-998-3440 x 538

Email: [cs@dpsi-usa.com](mailto:cs@dpsi-usa.com)

### Tech Support:

Phone: 877-998-3440 x 539

Email: [ts@dpsi-usa.com](mailto:ts@dpsi-usa.com)

### Fax:

714-998-3509

Rev 030608

# Table of Contents

Chapter 1.Introduction to the Digital Video Recorder (DVR).....	1
Chapter 2. Unit Description.....	2
A. DVR Front Panel.....	2
B. DVR Rear Panel.....	4
Chapter 3.Gettling Started.....	5
Chapter 4.Hardware Installation.....	6
A. Connecting DVR to Your TV Set.....	6
B. Camera Installation.....	7
C. Sensor Installation.....	9
D. Alarm Installation.....	10
E. LAN-DVR Connection.....	11
F. Power Connection.....	12
Chapter 5 DVR Menu.....	13
<b>Main Menu</b> .....	13
1. Camera Setup.....	14
2. Record Setup.....	15
3. Record Frame Rate.....	16
4. Video Quality.....	16
5. Record Schedule.....	17
6. Sensor Setup.....	18
7. Hard Drive Setup.....	20
Hard Drive Format.....	21
8. Miscellaneous Setup.....	22
(1) PASSWORD CHANGE.....	23
(2) SET TIME.....	24
(3) HIDDEN CHANNEL.....	24
(4) AUDIO PORT SETUP.....	25
(5) PTZ SETUP.....	26
(6) COLOR SETUP.....	27
(7) PASSWORD CONTROL.....	28
9. Network Setup.....	28
10. Video Backup.....	32
11. Reset Menu.....	33
A. Record Control.....	34
B. Record Playback Control.....	34
C. Record Mode.....	36
D. View Control.....	36
Chapter 6.USB Program (optional).....	37
Chapter 7.Trouble Shooting Guide.....	40
Appendix .....	42



## GENERAL SAFETY



Review the following safety precautions to avoid injury and prevent damage to this product or any products connected to it.

**1. Use proper power source**

Do not operate this product from a power source that applies more than the specified voltage (90~260 VDC).

**2. Do not insert anything metallic into the DVR case.**

Putting something into the DVR case can be a source of dangerous electronic shock.

**3. Do not operate in wet or dusty conditions.**

Avoid places like a damp basement or dusty hallway.

**4. Do not expose this product to rain or use near water.**

If this product accidentally gets wet, unplug it and contact an authorized dealer immediately.

**5. Keep product surfaces clean and dry.**

To clean the outside case of the DVR, use lightly dampened cloth with water (no solvents).

**6. Provide proper ventilation.**

This DVR has a built in fan that properly ventilates the system.

**7. Do not operate with suspected failures.**

If there are any unusual sounds or smells coming from the DVR, unplug it immediately and contact an authorized dealer or service center.

**8. Do not attempt to remove the DVR cover.**

Warning: You may be subjected to severe electrical shock if you remove the cover of the DVR.

**9. Handle DVR box carefully.**

If the DVR is dropped on any hard surface it may cause a malfunction, If it stops working properly due to physical damage contact an authorized dealer for repair or exchange.

**10. Use standard lithium cell battery. (NOTE: Manufacturer has preinstalled battery.)**

The standard lithium cell 3v battery located on the mother board should be replaced if the time clock does not hold its time after the power is turned off. Warning: unplug the DVR before replacing battery or you may be subjected to severe electrical shock. Properly dispose of old batteries.

**11. Install this product where there is good air circulation.**

This DVR system contains a hard drive which generates much heat during operation. Therefore do not block the air holes (bottom, upper side and back) of the DVR that cool down the system while running. Install or place this product in an area where there is good air circulation.

# **Chapter 1. Introduction to the Digital Video Recorder (DVR)**

The following document is a reference for Vineyard Teneyard Technologies' Digital Security System, designed to simultaneously record/retrieve up to 4 or 9 channels of video streams. It utilizes the latest digital image compression technology to compress the input channel video streams, and uses a hard drive to record the compressed video streams.

.Chapter 4. "Hardware Installation" explains how to install the DVR and other accessories in your home.

.Chapter 5. "DVR Menu" explains how to operate and manage the DVR.

## Chapter 2. Unit Description

### A. **DVR Front Panel**

This chapter briefly describes the buttons on the front panel of the DVR. These buttons operate the basic functions, such as recording, playback, fast-forward, reverse, etc. For more details on the DVR's on-screen menu, refer to "Chapter 5. DVR Menu."



#### (1) **CH1, CH2, CH3, CH4, QUAD**

These buttons allow you to select camera images in live recording or playback mode. There are 5 display mode selection buttons on the front panel. The default display setting of the DVR is to show all 4 channels on your TV screen at the same time. However, when you want to see only one channel full screen, which means one large image, you can simply select one channel and it will be displayed. If you push "QUAD" camera selection button, the DVR will display all 4 channels (cameras) at the same time in quad screen.

#### (2) **REC**

Press "REC" button to start recording. A "Z" marked on the selected channel/s of the screen means that channel is now recording.

#### (3) **STOP**

To stop playback or recording press the "STOP" button. When you Press "STOP" button while DVR is recording the recording indicator "Z" on the screen will disappear.

#### (4) **PLAY**

After recording, press the "PLAY" button to start video playback. Playback will start with the latest event and continue playing sequentially through the contents on the hard drive.

Please see "Playback Control" in Chapter 5 for more details.

#### (5) **FF**

To play the recorded video faster, press the "FF" button.

There are six levels of fast forward playback speed.

- (a) FF1: Plays every frame without skipping any video frames at the speed of 60FPS.
- (b) FF2: Plays two times faster (x2) than the normal play.
- (c) FF3: Plays three times faster (x3) than the normal play.
- (d) FF4~6: Increased playback speed by skipping more frames at a time during playback. To change the fast forward play back speed level, press the "FF" button again.

**(6) REW**

To play the recorded video backward, press the “REW” button.

There are 6 modes of REW, 1~6. To change the reverse playback speed level, press the “REW” button again.

**(7) PAUSE**

To pause the video playback, press the “PAUSE” button.

Then the video display will be stopped.

To continue playback, push the play “PLAY “ button or “PAUSE” button again to resume the previous mode.

**(9) MENU/ESCAPE**

To display the menu options, press the “MENU” button. Also used to Escape from current screen to previous screen

**(10) UP (c) /DOWN (d) /RIGHT (f) /LEFT (e)**

To change a menu field or change the DVR configuration values, use the UP, DOWN, LEFT, RIGHT buttons.

**(11) SELECT/EDIT**

This button is used to change the setup value.

**(12) LED Light**

There are LED lights located on the front panel (some models on the side panel). When the LED light is ON, it indicates the following conditions:

- (a) Red LED-Hard Drive is currently recording video.
- (b) Green LED-Power is on.

**(13) Power Button**

Press Power button to shut down DVR

**(14) PTZ Button**

Activates buttons for Pan-Tilt-Zoom camera control

## B. DVR Rear Panel.

[Note] See “Chapter 4. Hardware Installation” for more details.



### (1) VIDEO OUT

Connect DVR to TV monitor using a RCA cable or BNC cable with RCA adapter.

### (2) VIDEO IN (or CHANNEL IN)

Connect cameras to DVR. Each channel port indicates a single camera connection. The DVR has 4 camera connection ports.

### (3) SENSOR

You can use this sensor terminal block to install up to 4 motion sensors into the DVR. If you add the motion sensor devices to your DVR, the video recording can be triggered by motion detection. Even though you do not install motion detection hardware, you can utilize soft motion detection. (Refer to Chapter 5, Section O-Sensor Setup)

### (4) ALARM

There is an alarm output terminal in case you need to install alarm devices.

### (5) AUDIO IN

Use this port to connect DVR to cameras that have a microphone function so that you can record sound. There are two audio input ports.

### (6) AUDIO OUT

Connect DVR to “AUDIO IN” on your TV so that you can hear recorded sound from TV speakers.

### (7) LAN

Using an Ethernet cable, connect the DVR to your computer or routing device, such as a DSL modem or hub. The LAN (RJ-45) jack is for remote viewing of the DVR via the Internet.

### (8) AC-DC POWER ADAPTER JACK

Connect the power adapter into the DVR and plug the power cable into the wall. Some DVR models do not have a power adapter so you may not see this. In case, just plug power cable from the behind of the DVR into the wall

### (9) USB 2.0 PORT

Used to back up files to PC using PC Viewer software.

## Chapter 3. Getting Started

- (1) Install a hard drive into your DVR (some models come with the hard drive already installed).
- (2) Connect the DVR to a TV set.
- (3) Connect cameras (up to 4) to the DVR.
- (4) Connect the LAN cable from the DVR to a network router (optional)
- (5) Connect any other accessories (sensors or alarms) if necessary.
- (6) Plug the power cord into the power outlet on the wall.

**Notice: We STRONGLY recommend that you plug the DVR and cameras into a Transient Voltage Surge Protector (UL-1449 rating). Look for a clamping voltage of 330 or lower, Joule rating of at least 400, and a response time of 10 nanoseconds or less.**

- (7) Turn on the power switch on the DVR.
- (8) Start TV Monitoring and Recording.

Here is a check list to use when using the DVR.

- a. Make sure that a hard drive and camera(s) are properly installed (see “Chapter 4. Hardware Installation”)
- b. The hard drive jumper setting must be set to master (see “Hard Drive Installation” in Chapter 4). Otherwise the DVR may not boot up.
- c. The software used for the DVR is not compatible with your computer’s operating system (ie, Windows). Therefore you cannot take the hard drive from this DVR and install it into your computer to view recorded videos.
- d. The DVR offers you the flexibility to choose between a faster recording frame rate (Maximum Rate:30 frames per second) for more natural motion or recording at a slower frame rate and maximizing hard drive space. On a 120GB hard drive you will be able to record for up to six months using the slowest frame rate of one frame per second.
- e. There is an exception to entering “View” mode at start up. If the power is turned off while recording (ie. a power failure), the DVR will enter ”Power Recovery” mode at start up, detect that it has been shut down, and then re-initialize the recording process.

**Notice: See the next Chapter 4 “Hardware Installation” for more details such as hard drive and camera installation.**



## Chapter 4. Hardware Installation

### A. Connecting DVR to Your TV Set

#### (1) Video Input/Output Connection (For TV monitor screen display)

Any TV set that has a “RCA Video Input” terminal is suitable for displaying the picture. The figure below shows the video signal line connection.

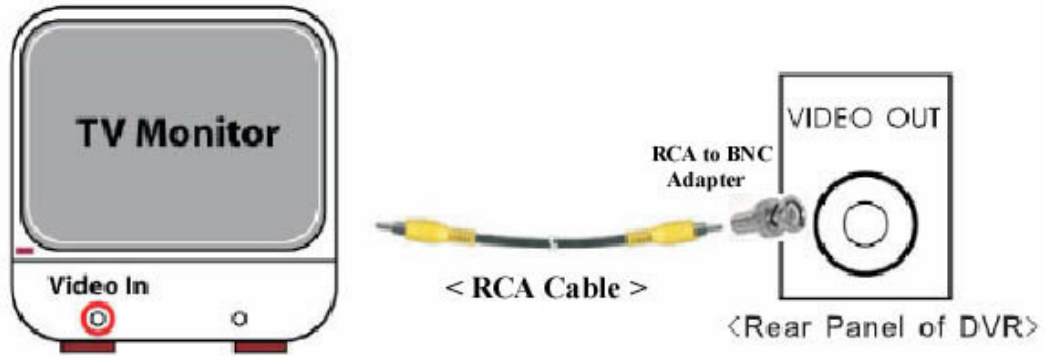

<“Video in” on TV>

Using a RCA cable, connect “VIDEO IN” on your TV to “VIDEO OUT ” on the rear panel of the DVR.

**Notice: You need to purchase a RCA cable separately for connecting to the Video In port on the TV. A RCA female to BNC male adapter is provided for connecting the cable to the Video Out port of the DVR.**

#### (2) Audio Input/output connection(For TV speaker)

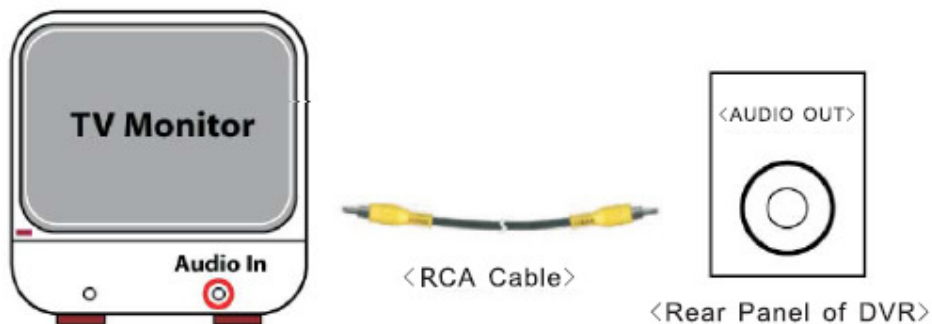

<“Audio in”of TV>

Using an RCA cable, connect “AUDIO IN” of your TV to “AUDIO OUT” port on the rear panel of the DVR.

**Notice: You need to purchase a RCA cable separately for connecting to the Audio In port on the TV.**

## B. Camera Installation

### (1) For cameras that have no built-in microphone

If your cameras have cables consisting of power and video cables, connect "VIDEO IN" of your DVR, using the combined camera cable included in the package, and plug in the camera power adapter.

<Connection Type1-For indoor/outdoor cameras or other brands that come with a splitter cable>

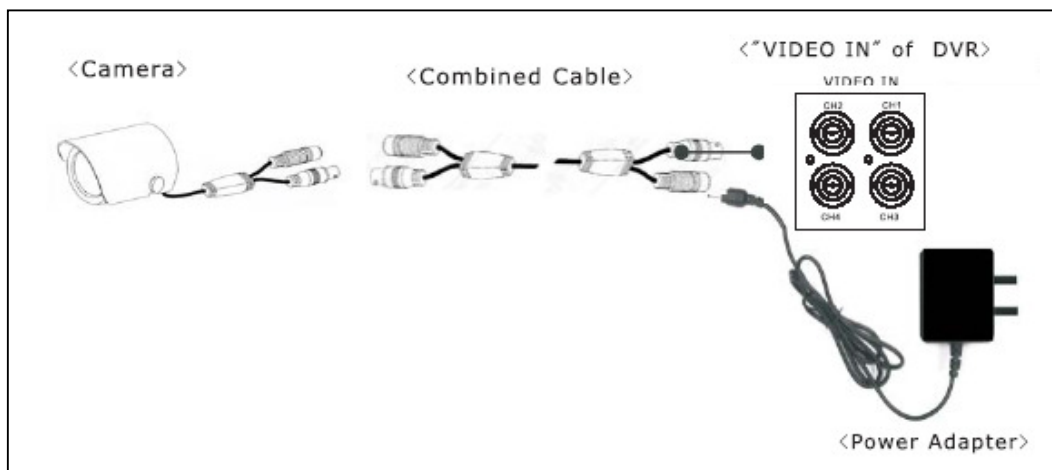

<Connection Type2-For cameras that have a video output port on the rear>

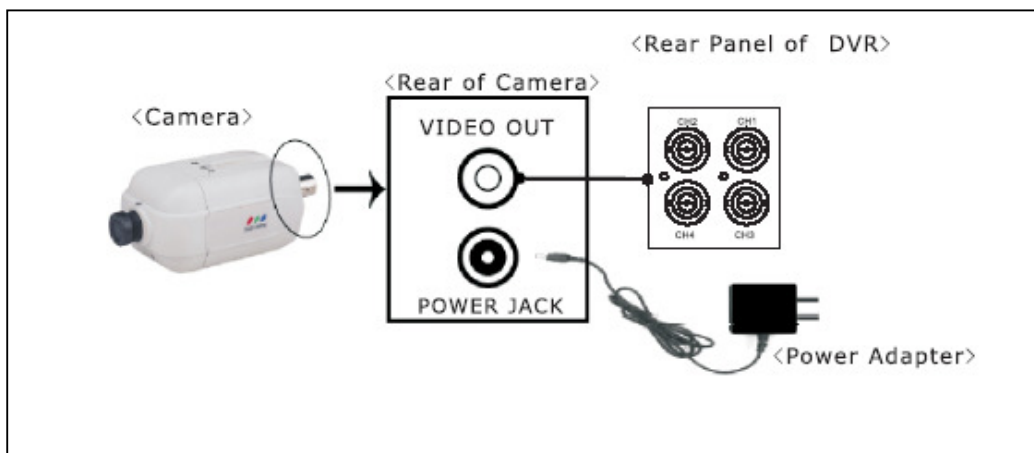

**(2) For cameras that have a built-in microphone**

If you're purchased cameras that have a built-in microphone, follow the diagram below for installation.

<Connection Type 1-For cameras that comes with a video/audio splitter cable>

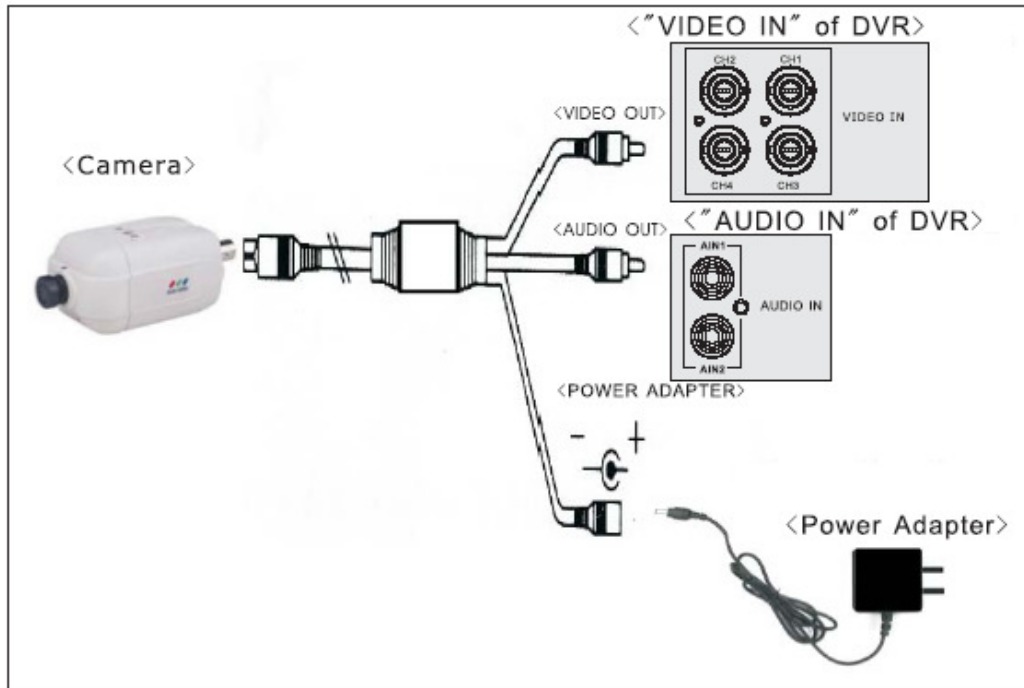

<Connection type2-For cameras that have direct video/audio output holes>

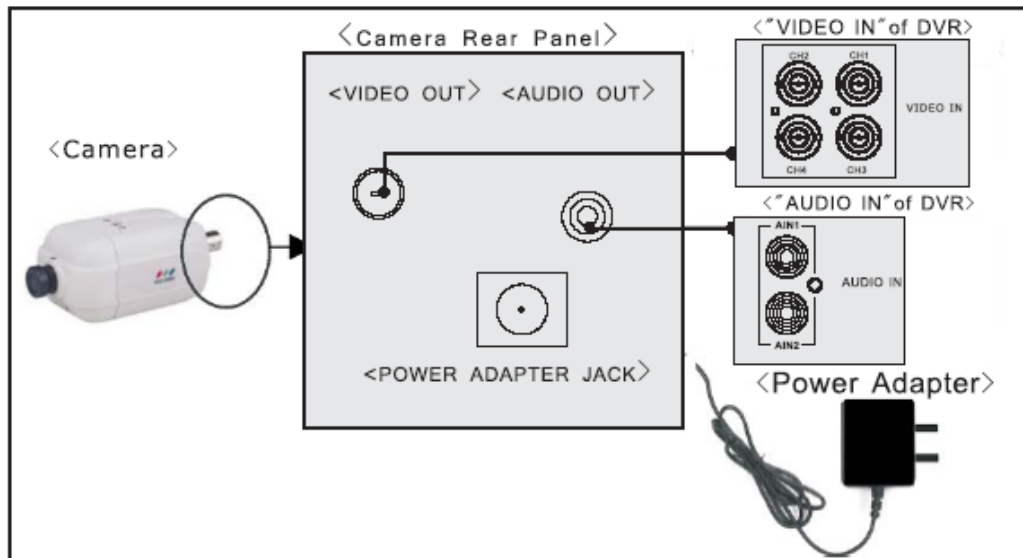

### C. Sensor Installation

The DVR can support up to 4 sensors (not included in the DVR package) in up to four locations.

There are two steps for sensor installation:

- (a) Connect the sensor signal lines to the signal input terminal.
- (b) Connect the sensor power lines to the appropriate power source.

In general, there are three different types of sensors readily available for purchase:

- (1) Normal-Close (2) Normal-Open (3) Normal

[DVR-Sensor installation Diagram]

Close/Open. Below is a brief diagram on how each type of sensor is installed into the DVR. The procedure for sensor installation is shown below:

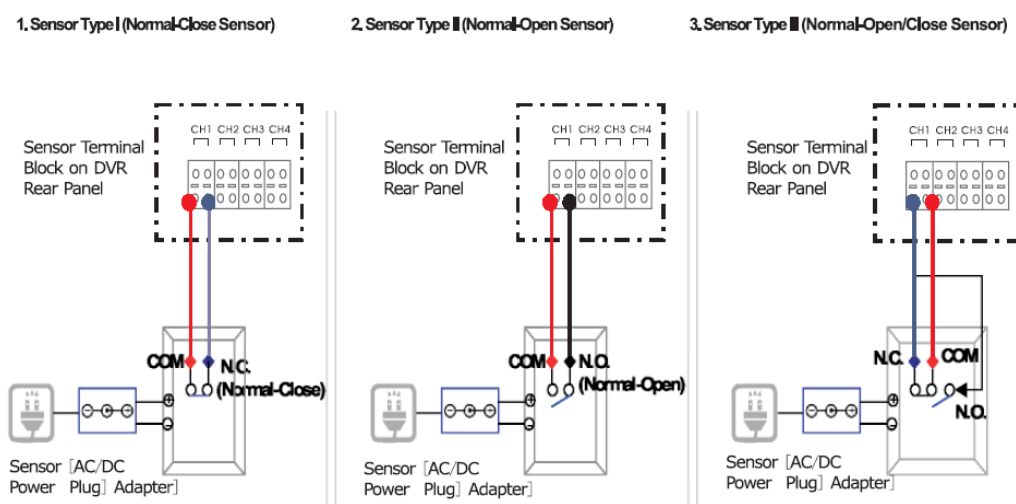

#### Notice:

**\*After you install sensor(s), the programmed recording mode must be set to “S” for “sensor” during the hour that you are recording (See “Chapter 5.H.Record Schedule”).**

**\*Contact an authorized dealer for information about buying the appropriate sensors for your needs and for information concerning proper installation procedures.**

#### D. Alarm Installation

The DVR has an internal switch for sounding an alarm. The switch is normally open, but when the sensor is triggered, the alarm is activated as well. The circuitry is as follows:

There are two steps for alarm installation.

- (a) Connect the alarm power lines to the alarm switch terminal.
- (b) Connect the alarm power lines to the appropriate power source.

The following diagram shows how you install an alarm device into your DVR.

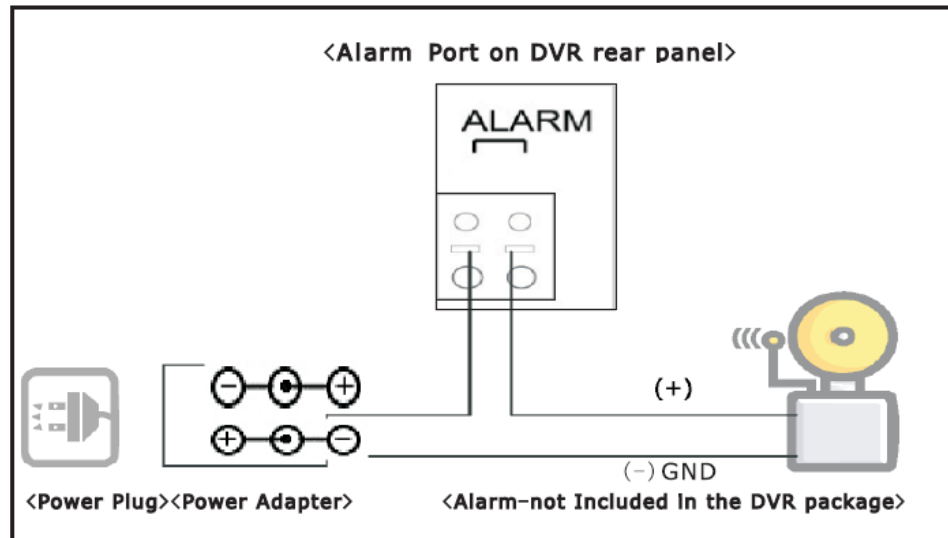

### E. LAN-DVR Connection

See the diagram below for steps to connect your DVR to a local area network or the internet. For remote monitoring from your computer, you must have a LAN connection available or Internet access service.

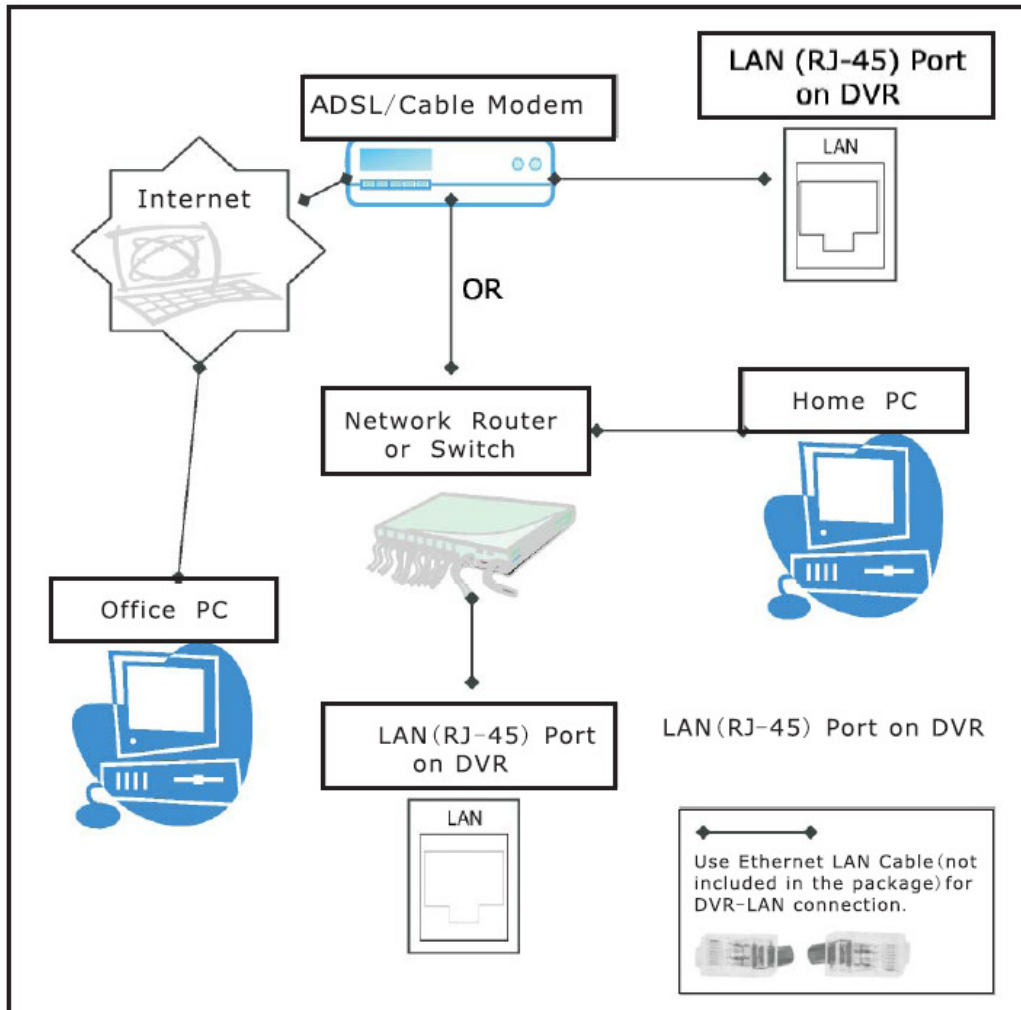

## F. Power Connection

Connect the DVR power adapter at the back of the DVR unit.

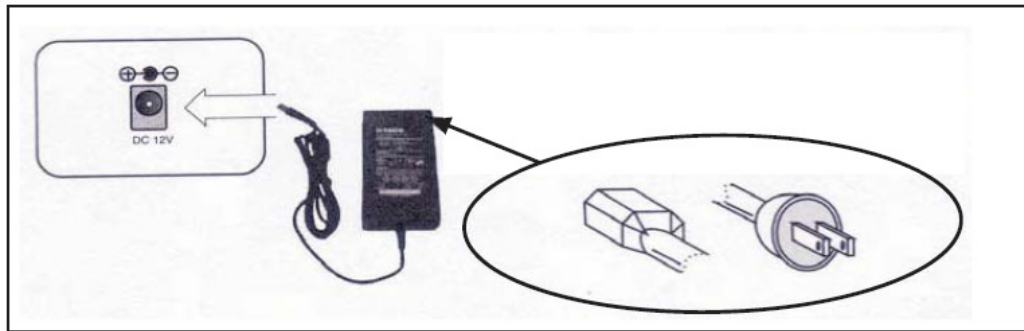

**Notice: We also STRONGLY recommend that you plug the DVR and cameras into a Transient Voltage Surge Protector (UL-1449 rating). Look for a clamping voltage of 330 or lower, Joule rating of at least 400, and a response time of 10 nanoseconds or less.**

Now the DVR is ready to go!! Turn on the power button at the front of the DVR.

The next chapter will explain about the DVR menu and how to operate the DVR.

## Chapter 5. DVR Menu

Below you will find a screen shot of the DVR main menu. Press the MENU button to display the screen.

### Main menu



Press [MENU] to enter main menu. Use [UP] and [DOWN] to select item.  
Press [SEL] to modify setting and [MENU] to confirm and exit.



## 1. Camera Setup

There are 4 cameras that can be connected to the DVR. Use the key buttons on the front panel to select which cameras are turned ON or OFF for real-time viewing on the screen, change ON/OFF by pressing the 'SELECT' button.

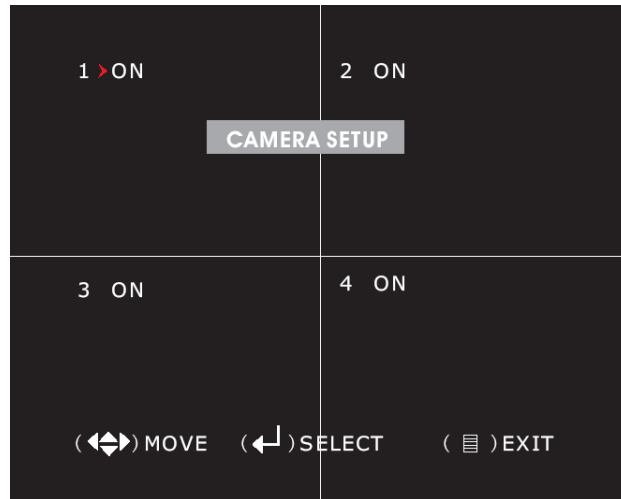

In the example above, cameras 1,2,3,4 are ON.

## 2. Record Setup

SELECT  
CAMERA(S)  
FOR  
RECORDING

Selecting the camera channel/s on RECORD SETUP menu is the same as CAMERA SETUP options.

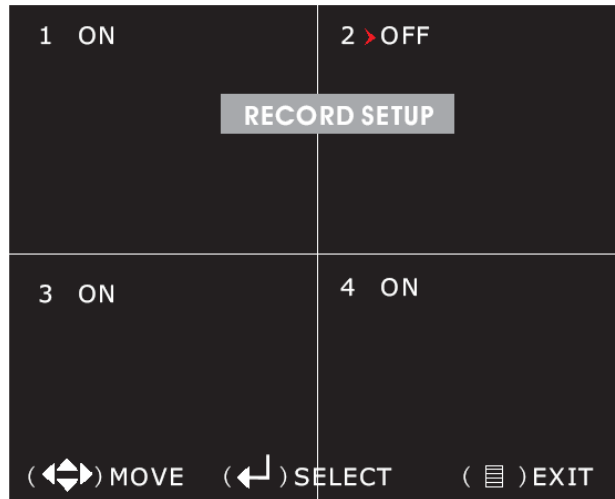

Choose the cameras you want to Record by selecting "ON"

### 3. Record Frame Rate

ADJUST BETWEEN 1 TO 25 (PAL) OR 1 to 30 (NTSC) FRAMES PER SECOND

The total frame rate per second is 50/60. You can set the frame rate per channel (1-25)/(1-30). If the frame rate you select causes the total frame rate to exceed 50FPS the software automatically changes the largest frame rate value to a smaller value.

The higher the record frame rate, the more natural movement will appear during playback. The lower record frame rate, the more space you will save on the hard drive. There are various record frame rate settings to choose from.

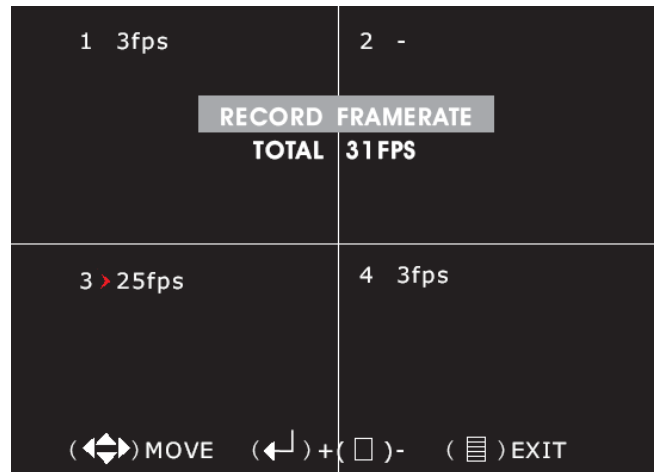

### 4. Video Quality

Highest  
High  
Normal  
Low

There are four different video quality settings, The higher the video quality is the clearer the image will be during playback. The lower the video quality is the more space you will save on the hard drive.

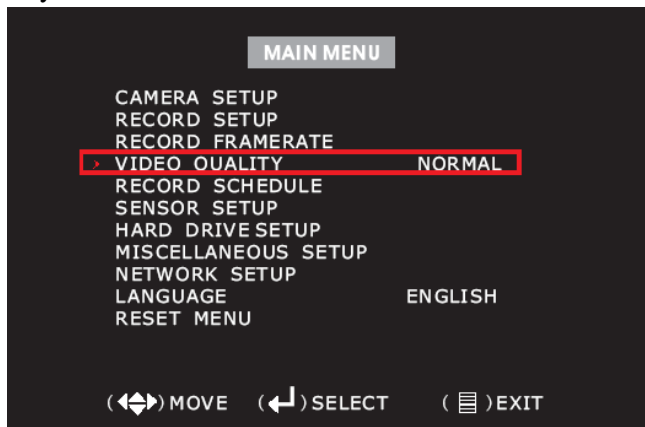

The video quality in View Mode is not affected by the video quality setting, These settings only affect the video quality during playback of a recording.

## 5. Record Schedule

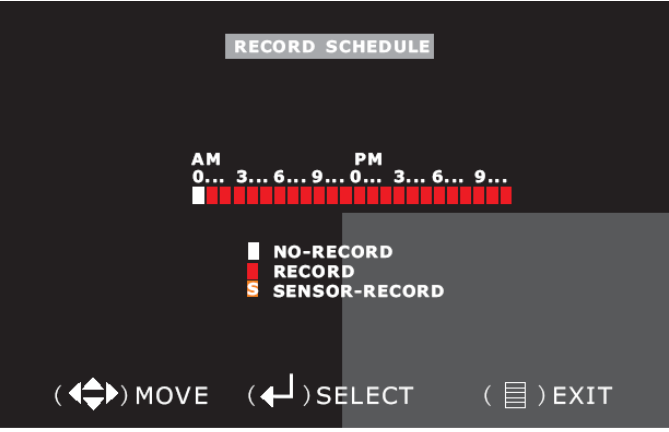
<p><b>.ALWAYS</b> <b>.SENSOR</b> <b>.NO REC</b></p>	<p>The time line below indicates the hours of the day based on an AM/PM clock. For each hour you may select between NO RECORD, RECORD, or SENSOR-RECORD.</p> 
	<p>Press the “LEFT” and “RIGHT” arrows to maneuver and use the “SELECT” button to change between continuous recording, sensor recording and no recording, Once you have finished, press ”MENU” to exit.</p> <p>(RECORD) System will record continuously during this period. (SENSOR-RECORD) System will record when sensor is triggered.</p> <p>(NO-RECORD) System will not record during this period.</p> <p>You must press the “REC” button to record in these three modes.</p>

## 6. Sensor Setup

**Notice: You need to buy sensors separately to make sensed alarm recording functions operate on your DVR system.**

### MOTION SENSOR RECORDING

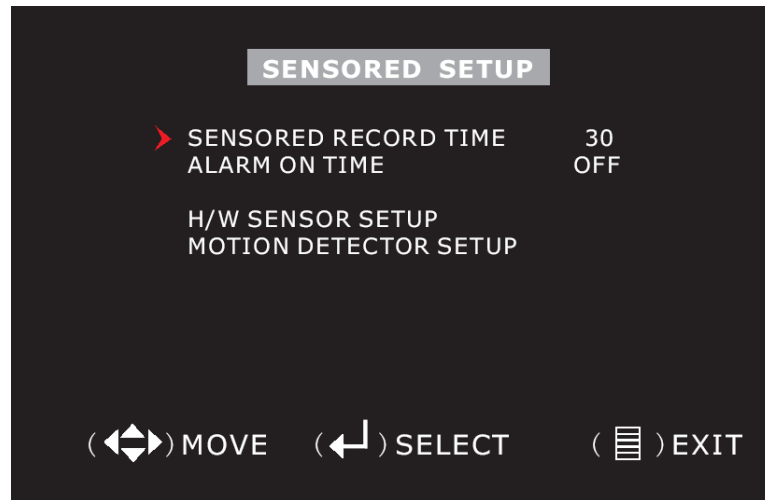

#### **SENSORED RECORD TIME**

This indicates the length of recording time after the sensor's last detection of movement.

#### **ALARM ON TIME**

It indicates how long the alarm lasts after a sensor is triggered.

\*SENSORED RECORD TIME and ALARM ON TIME are measured in seconds.

#### **HARDWARE SENSOR SETUP**

It indicates the sub menu for setting up the external motion sensor devices.

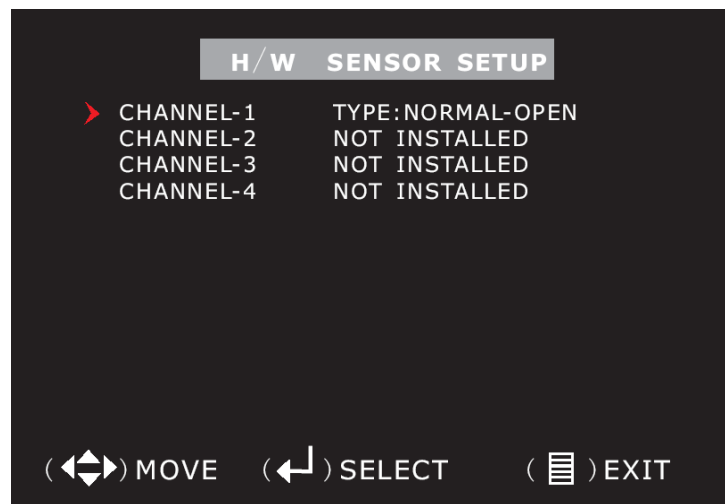

In this example, Channel 1 has sensors installed, Open and Close, respectively.

#### MOTION DETECTOR SETUP

This indicates the sub menu for setting up the software motion detection without any external sensor devices.

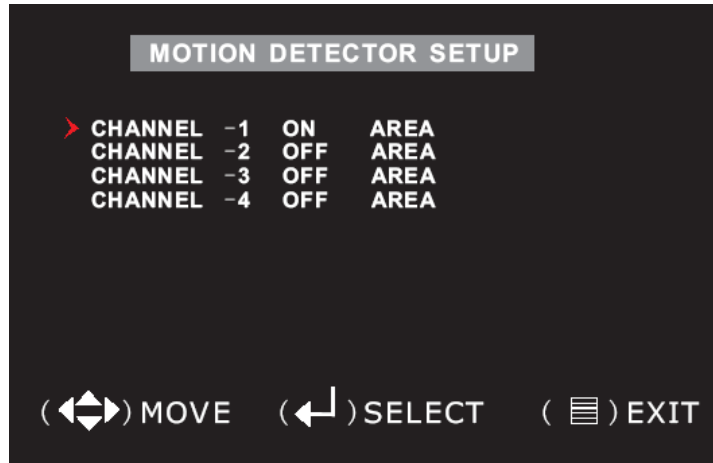

In this example, Channel 1 has Motion Detection enabled.

#### MOTION SENSOR RECORDING

The image below shows the Motion Detection Area setup. As you see in the example below there are 3 shaded regions. Each region represents different levels of motion sensitivity required to activate sensor recording.



Adjust the sensitivity by first selecting the specific region in the view you would like to set. Then press 'STOP' button to adjust the sensitivity.

A blinking block (cursor) shows the particular setting sensitivity for that block. The Level 0 setting means the block area is disabled. Level 3 is the highest level of sensitivity. By pushing the "SELECT" button you can choose the sensitivity of the blinking block.

## 7. Hard Drive Setup

### HARD DRIVE INFORMATION

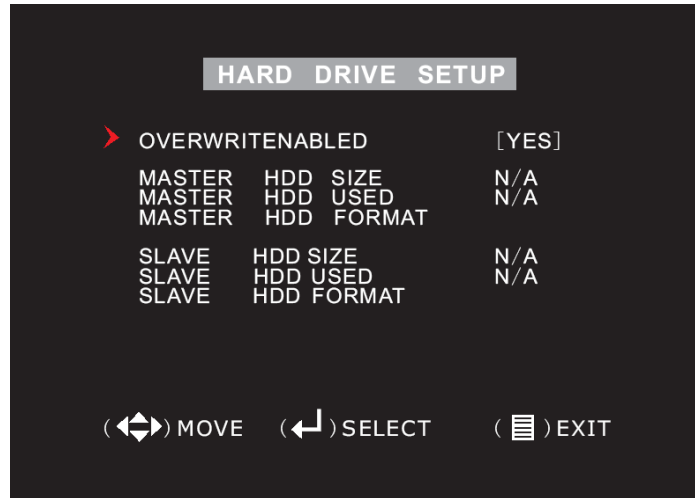

#### 1.OVERWRITE ENABLED:

If you choose YES (default setting), recording continues and overwrites oldest previous recordings when hard drive space is Full. If you choose NO, the recording session stops when the hard drive capacity is full.

#### 2. MASTER HDD SIZE:

This shows the size of the primary hard drive installed in the DVR.

#### 3. MASTER HDD USED:

This shows the space used on the primary hard disk drive for recording.

#### 4. MASTER HDD FORMAT:

If you format the hard drive, it will erase all the data recorded on the primary hard drive.

#### 5. SLAVE HDD SIZE

This shows the space available on the secondary hard drive in the DVR.

#### 6. SLAVE HDD USED

This shows the space used on the secondary hard disk drive for recording.

#### 7. SLAVE HDD FORMAT

If you format the hard drive, it will erase all the data recorded on the secondary hard drive.

**NOTICE: This DVR does not support a slave hard drive.**

## 7.1 Hard Drive Format

HARD DRIVE FORMAT	When you press the “SELECT” key you will be prompted to input a Password when the hard drive format menu appears.
	Type Password (6) ::—————
	When you key in the correct password the following message will flash 3 times. “password correct Hard Disk Formatting...” Otherwise, the following error message will be displayed on the screen. “Password Incorrect” <b>Notice: The Factory Default password is 11111. This number (1) corresponds with the button for camera “one” on the front of your DVR.</b>



## 8. Miscellaneous Setup

**.CHANGE  
PASSEWORD  
.SET TIME  
.HIDDEN  
CHANNEL(ON/OFF)  
.AUDIO PORT  
SETUP  
.PTZ SETUP  
.COLOR SETUP  
.PASSWORD  
CONTROL**

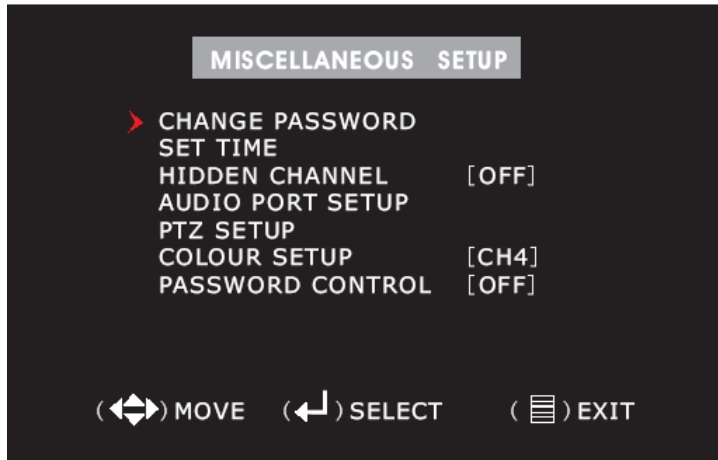

## (1) PASSWORD CHANGE

•**6-DIGIT  
PASSWORD**  
•**DEFAULT  
PASSWORD  
SETTING:  
11111**

When you select “CHANGE PASSWORD”, the menu below will open.

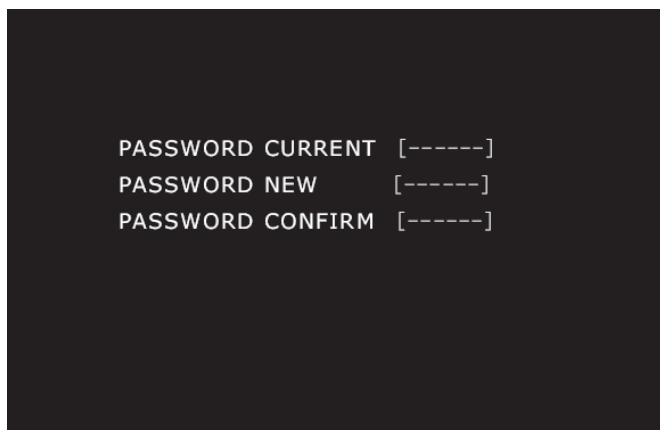

1. Press the channel 1 button six times.
  2. Once you have input the current password, you can set a new password.
  3. Then confirm the password you have set.
- You can use a combination of any of the buttons, except the [MENU] button on the front of your DVR to set a new password
  - When the new password is accepted the following screen message will flash: “Password changed”
  - The message will blink 3 times. Then the “MENU” will return. If the password is not accepted you will receive a message that informs you that it was not accepted and the “MENU” returns. You may try again by repeating the same steps.

**NOTICE: The Factory Default Password is 11111. This number (1) Corresponds with the button for camera “one” on the front of your DVR.**

## (2) SET TIME

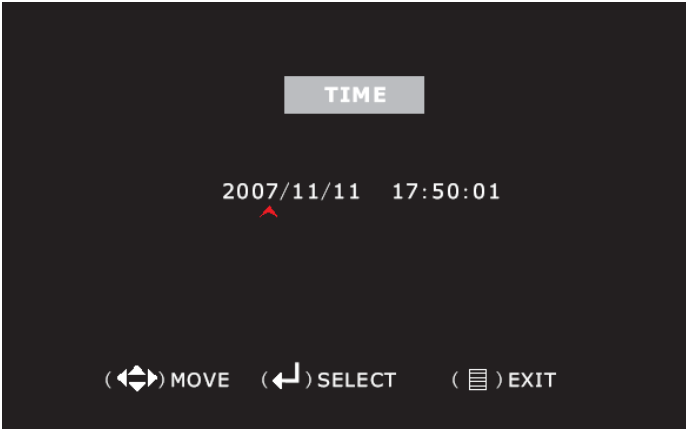
<p>.Year .Date .Hour .Minute Second</p>	<p>You can change year/date/hour/minute/second by using the SET TIME menu.</p>
	
	<p>2007/11/11=year/month/day 17:50:01=hour/minute/second Use the “LEFT” and “RIGHT” buttons on the front panel to move the cursor below the numbers back and forth. Then use the “SELECT” button to change the numeric values of date &amp; time.</p>

## (3) HIDDEN CHANNEL

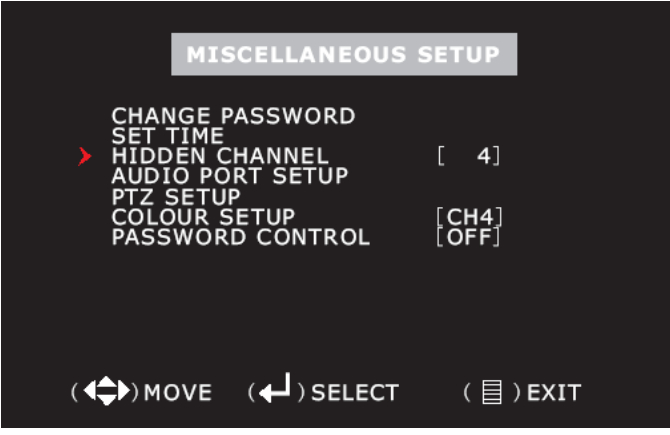
<p><b>In the example, select HIDDEN CHANNEL [4], camera 4 IS hidden.</b></p>	
--	--

#### (4) AUDIO PORT SETUP

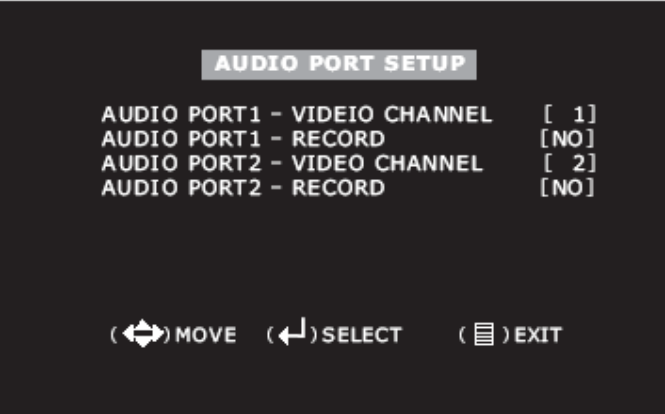
<p><b>AUDIO CHANNEL NUMBER</b></p> <p><b>AUDIO RECORD, MUTE YES/NO</b></p>	
	<p>When you move the cursor to “AUDIO PORT RECORD” and push the “SELECT” button, the option will be changed to NO or YES .If the option is YES, the audio will be recorded onto the hard drive when you push the RECORD button.</p> <p>When you move the cursor to “AUDIO PORT VIDEO CHANNEL” and push “select” button the option will be changed to “2”. If you push “SELECT” button one more time the option will be changed to “3” and one more time will set the channel to “4”.</p>

For Example

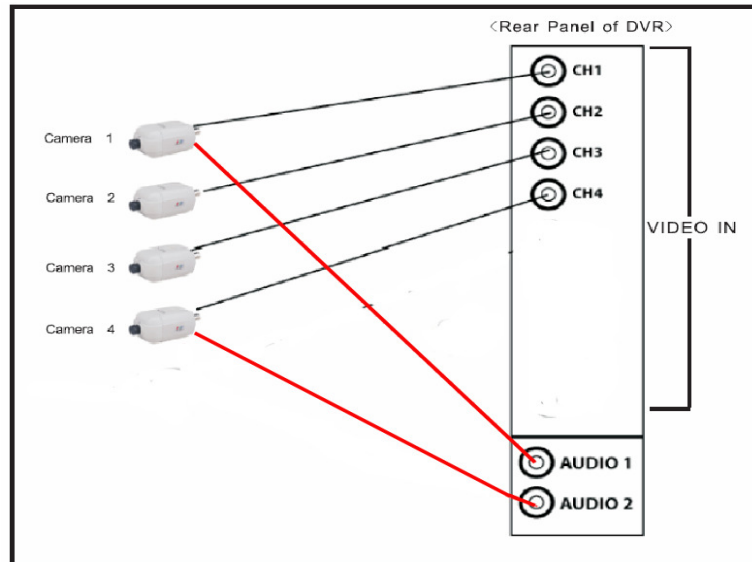

The setup screen for the above configuration would look like this:

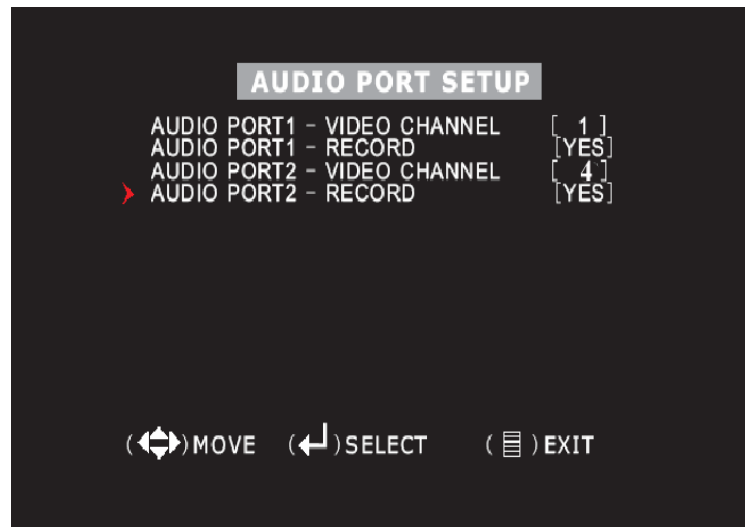

### (5) PTZ SETUP

This DVR can control speed dome cameras (PTZ), which are connected to the DVR.

**SPEED:** Set the band rate of each channel (2400, 4800, 9600, 19200, 38400, 56000)

**PROTOCOL:** Select PELCO-P or PELCO-D protocol.

**CAMERA&ID:** Set camera (1-4); Set ID (1-32)

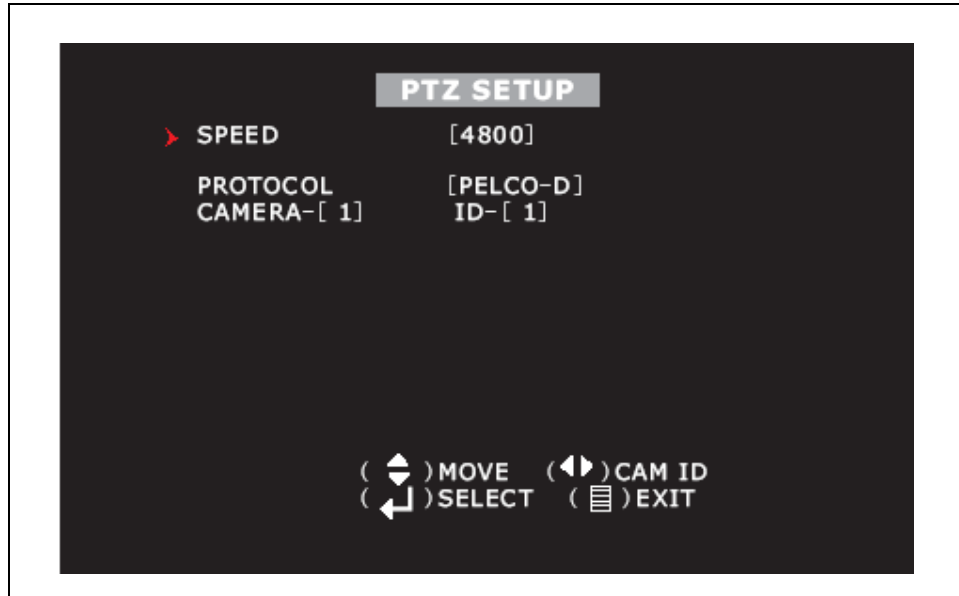

**(6) COLOR SETUP**

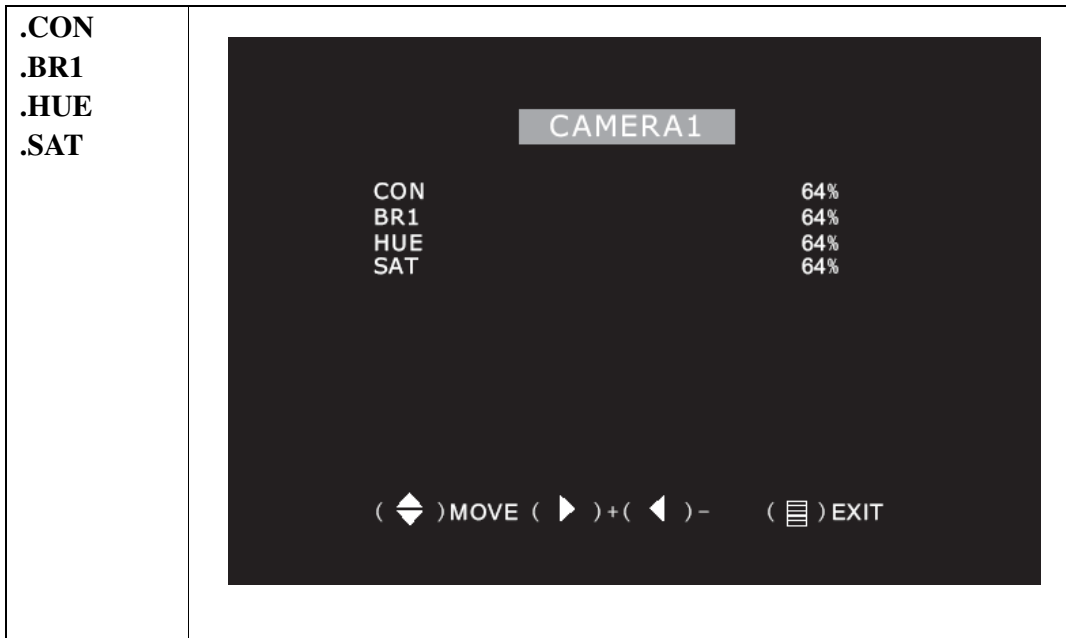

**(7) PASSWORD CONTROL**

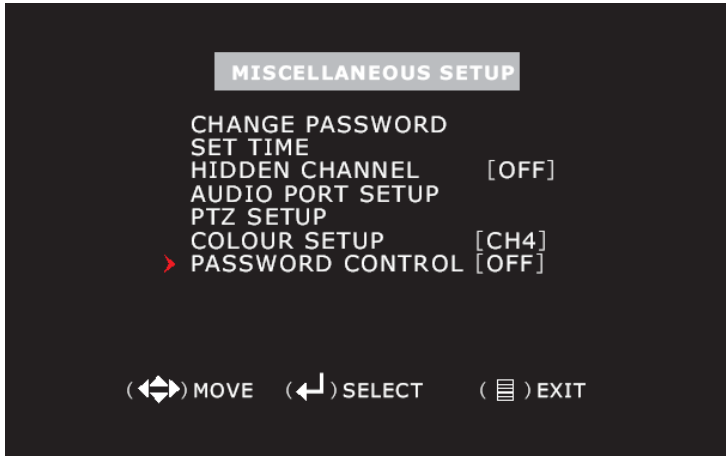
<p>•PASSWORD CONTROL</p>	
--------------------------	--

## 9. Network Setup

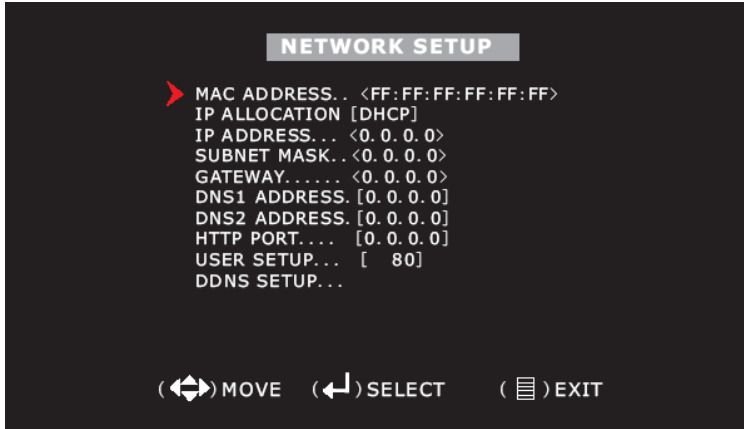
<p><b>NETWORK SETUP</b></p>	
	<p>Note: The default MAC address is: “00-11-22-33-44-55”, but after “00” the address will be set by the system!.</p> <p>Use the UP “▲” and DOWN “▼” buttons to left to right and use the “SELECT” button to change the numbers.</p> <p>.Once you have finished making your changes, press the “MENU” button.</p> <p>.Press the “MENU” button again to exit NETWORK SETUP.</p> <p>.For more details about each network configuration item, see the following:</p> <p style="text-align: center;">-28-</p>

## Accessing the DVR over a network

To access the DVR through a computer you need to make sure the default gateway on the DVR is the same IP address as your router, and the first three sets of numbers of the DVR IP address are the same as the first three sets of numbers of router's address. Example: if your router's default gateway is 192.168.1.1 then the default gateway setting in the DVR should be 192.168.1.1, and the first three sets of numbers on the DVR's IP address should be 192.168.1. The last set of numbers has to be different than those on any other devices attached to the router to avoid conflicts. The subnet on the DVR also needs to be the same as the router, example: if the subnet on the router is 255.255.255.0 the subnet on the DVR needs to be 255.255.255.0. To get the default gateway and subnet of the router, on a computer that is attached to the same router as the DVR, click on the start button, then click on run, then enter cmd into the box and click on OK. At the cursor type ipconfig, the default gateway and subnet will be displayed.

**To access the DVR through Internet Explorer:** Once you have set up the network settings on the DVR to match the settings of your router, you need to modify your browser controls. You need to allow Pop-ups. To do so go to the Internet Explorer tool bar and select the "tools" option, then select the "Pop up Blocker" option and select "Turn Off Pop-up Blocker." You will also need to enable Active X controls. To do so go to the Internet Explorer tool bar and select the "tools" option, then "Internet Options", then "Security", then click the "Custom Level" button, and make sure the Active X Controls and Plug Ins are set to prompt or enabled. To connect to the DVR from the computer you would then open an internet browser window and enter the gateway IP of your router. You will get a login screen where you will need to enter your user name and password (admin and 12345 by default). The first time you connect a webcam program will be downloaded to your system and you may get a message that an ActiveX control on the page may be unsafe but it is ok to click the Yes option to download the control and program since you have requested the program.



### **Accessing the DVR from a remote computer**

To access the DVR from a remote computer, in addition to the above steps, you will also need to forward port 80 on the router the DVR is attached to, to the IP address of the DVR. (This port can be changed if the port is currently being used by another program.) How you would do this depends on the brand and model number of your router. You can go to [www.portforward.com](http://www.portforward.com) to get instructions on how to forward ports on most popular routers. To access your router's program you would open an internet browser window and type the default gateway of the router into the address bar at the top of the window. Then follow the instructions for your router.

**To access the DVR through Internet Explorer:** once you have setup the network settings on the DVR to match the settings of your router and forwarded the ports needed by the DVR, you need to modify your browser controls. You need to allow Pop-ups. To do so go to the Internet Explorer tool bar and select the "tools" option, then select the "Pop up Blocker" option and select "Turn Off Pop-up Blocker." You will also need to enable Active X controls. To do so go to the Internet Explorer tool bar and select the "tools" option, then "Internet Options", then "Security", then click the "Custom Level" button, and make sure the Active X Controls and Plug Ins are set to prompt or enabled. To connect to the DVR from the remote computer you would then open an internet browser window and enter the internet IP of your router. To get the internet IP of your router go to [www.myipaddress.com](http://www.myipaddress.com) from a computer that is attached to the same router as the DVR. You would then access the DVR by typing the IP address you got from [www.myipaddress.com](http://www.myipaddress.com) into the browser window (Example:http://70.69.120.123). You will get a login screen were you will need to enter your user name and password (admin and 111111 by default). The first time you connect a webcam program will be downloaded to your system and you may get a message that an ActiveX control on the page may be unsafe but it is ok to click the Yes option to download the control and program since you requested the program.

**Static versus dynamic addresses:** You can access the DVR through a static or dynamic IP address, however a dynamic address can change from time to time. How often depends on your service provider. We suggest [www.Dyndns.org](http://www.Dyndns.org) or [www.no-ip.com](http://www.no-ip.com) domain name service. If you register your domain name for the DVR, you can use this service to connect to your DVR without the need for a static or public IP address. You do need to leave a computer attached to the router and ON to be able to use this service, but it could help avoid the higher cost of having a static address.

<p>NETWORK SETUP</p> <p>-USER SETUP</p>	<div data-bbox="548 625 1289 1056" data-label="Image"> </div> <p>When a user connects to the DVR via the Internet, Internet Explorer will prompt the user to enter a username and password. There are two kinds of user, ADMIN and USER. The default value for username and password of “USER” is blank, Nothing. This allows the user to connect without username or password.</p> <p>However, in order to control the DVR, the user must login as “ADMIN”, and at that time must type the username and Password set by this menu.</p> <p style="text-align: center;">-31-</p>
---	---

NETWORK  
SETUP  
(cont.)

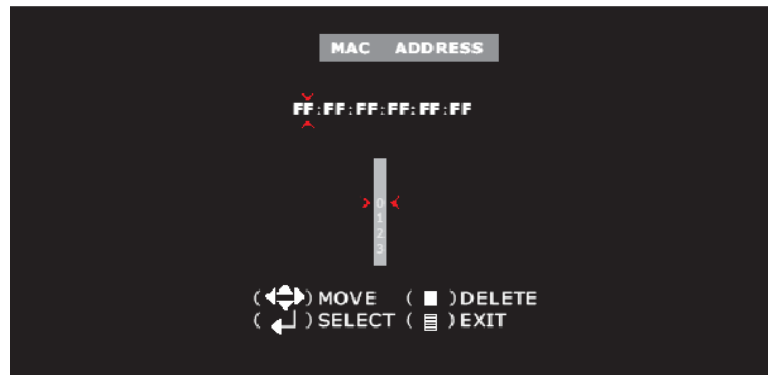
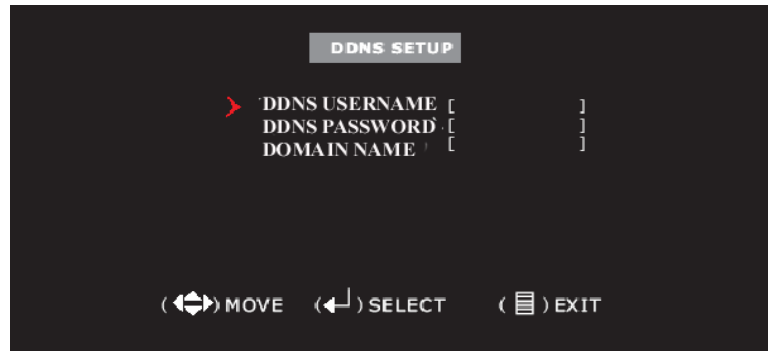

10.VIDEO BACKUP

VIDEO  
BACKUP



## 11. Reset Menu

RESTORE  
FACTORY  
DEFAULT  
SETTINGS

Selecting 'RESET MENU' will restore all of the factory default settings for the DVR.

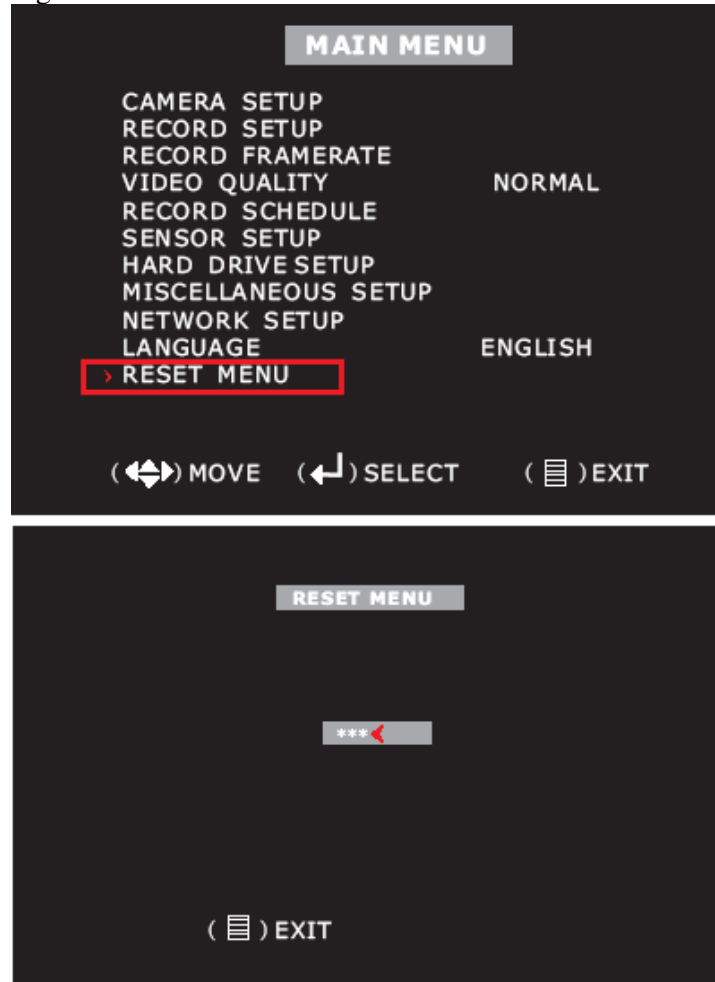

## A. Record Control

<p><b>RECORDING BY CAMERA</b></p>	<p>When the “RECORD” button is pressed, the recording process starts immediately. The recording channel indicators (red dot) next to CH1 and CH2 on the screen indicate that those channels have been selected to record and are recording.</p> 
-----------------------------------	--

## B. Record Playback Control

<p><b>PLAYBACK CONTROL</b></p>	<p>When you press the MENU button during PLAY mode, the SEARCH TIME window will open as illustrated below. While in this window, you can either choose and playback a recorded event or manually input a specific time to be viewed.</p> <p>To choose and playback a recorded event:</p> <p>When you first open the SEARCH TIME window, the arrow will be pointing at the most recent event. Use the “UP” and “DOWN” buttons to find the event that you want to view and then press the PLAY button. The event you have chosen will start playing.</p> <hr/> <p>2007/09/19=year/month/day 15:05:43=hour/minute/second</p> <p>When the arrow is pointing at a specific event, the date and time below HARD DRIVE: MASTER shows the beginning (date and time) to the ending (date and time) of that recorded event.</p>
--------------------------------	---

## PLAYBACK CONTROL

To manually input a specific time to be viewed:

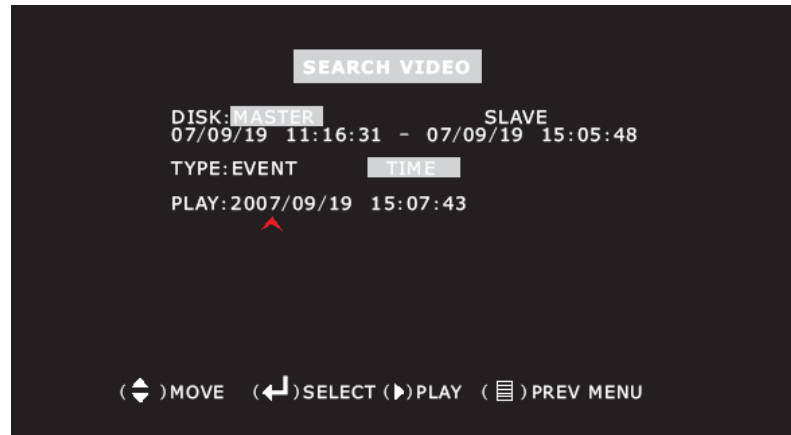

1. Open the SEARCH TIME window by pressing the “MENU” button during “PLAY” mode. The arrow will be next to the most recently recorded event.

The date and time displayed under HARD DRIVE: MASTER now corresponds with the beginning and ending period of what has been recorded on your hard drive.

2. Press the “DOWN” button and the arrow will move below the date and time references under HARD DRIVE: MASTER.
3. Move the arrow left or right by using the UP “▲” and DOWN “▼” buttons. Change the date and time digits by pressing the SELECT button.
4. Finally, input the desired starting date and time, press the “PLAY” button and the DVR will start playing.

## B. Record Mode

If you press the “REC” button, the DVR goes into “REC” mode. The DVR will start recording based on set “Record Schedule”. In record mode, you can change channel view and switch the audio channel. However, you cannot playback while in record mode.

## C. View Control

SINGLE OR MULTI-SCREEN VIEW Cam 1-4	In EACH mode, you can use the following keys to select the camera that you want to see in full screen during playback.
	Each View button controls FULL SCREEN display for the selected channel (From cameras 1-4)

## Chapter 6. USB Programming (optional)

### 6. USB Programming

#### 6.1 Install

1. Place the USB Driver Program CD into your CD ROM.
2. If your CD ROM does not auto-run the install CD, go to “My Computer”, select your CD drive, and click on “PCVIEWER.EXE”.
3. Follow the prompts on your PC to finish the installation.

#### 6.2 Program Interface



To run the program (Double click “” icon on your desktop).

System will detect the HDD automatically when you connect the USB cable to your PC.

Note: If the HDD is not detected, please perform the following steps:

- (1) Close the USB program window, and remove the USB cable.
- (2) Press [ PLAY] twice to put the DVR into the Playback mode.
- (3) Connect the USB cable to the PC again.

Please allow up to 30 seconds for the DVR to show video on your PC.

Please make sure that the PC has detected the hard drive before you double click player icon.



Button functions:



1.PTZ Control	11.Record
2.Zoom in, Zoom Out	12.Search
3.HDD Play Mode	13.Reverse
4.File Play Mode	14.Record
5.Net Play Mode	15.Stop
6.Event List	16.Pause
7.Control Panel	17.Play
8.Remote Login	18.Forward
9.Change Storage Device	19.Playback Slider
10.Capture Image	20.Audio Slider

Press  (button 6) to open the video event lists.

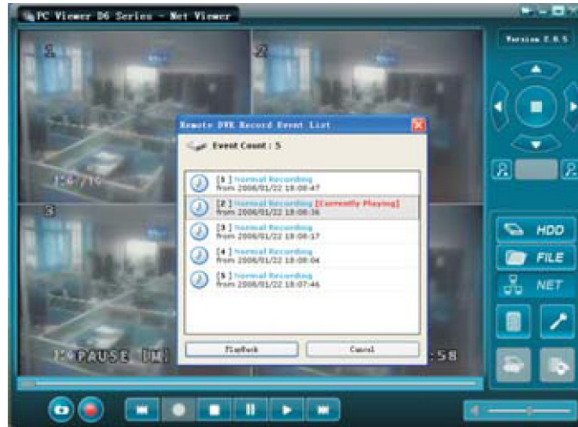

Press  (button 7) to configure the DVR play/record system.



Press  (button 17) to play video.



## Chapter 7. Trouble Shooting Guide

### **1. What kind of camera should I buy for this DVR?**

Any BNC or RCA interface indoor/outdoor/infrared camera will work with the DVR. It doesn't matter the color of the camera. However, web cameras that require a USB interface are not compatible with the DVR.

### **2. What kind of sensor device should I buy for sensor recording?**

Any motion detection sensor is compatible with our DVR.

### **3. What kind of alarm device should I buy for DVR?**

Most sound alarms are compatible with our DVR.

### **4. I can't turn on the DVR.**

Make sure that the power switch is on. If the power switch is on and you still can't turn on DVR, make sure that the power cord is plugged in correctly and the green power light on DVR front panel is on.

### **5. I see nothing but a blue screen after I turn on the DVR.**

Check the camera input and video output connection on DVR rear panel. If you can't find any problem with these connections, check whether the camera power cable is firmly connected.

### **6. I pushed the MENU button but it doesn't show the menu directory.**

When the DVR is in record mode no button on the front panel will work. You will see the yellow light on the front panel when DVR is recording. To end recording press the STOP button.

### **7. I push the Record button but nothing records.**

Make sure the "Record Schedule" menu shows that the current time is marked by a "red block" not a "white block".

### **8. I turn on the DVR and no buttons work.**

Make sure hard drive jumper is set as a "master". Check the two connectors (power cable & IDE cable) from hard drive to DVR to see if they are firmly connected.

### **9. I installed only one camera to channel 1 but channel 1 screen does not show anything.**

Under Menu and Camera Select, select 1.

### **10. Can I record everything 24 hours 7 days a week without stopping?**

Yes. On Record Schedule on the Menu, select "Red Block" for 0-24 periods.

### **11. Can I prevent other people from stopping the recording while I am gone? Would creating a password do it?**

The only way to prevent it is to place the DVR in a room where nobody else can enter.

**12. Can I still record all the events while I review the previous recording?**

No. This DVR currently doesn't support recording while playback.

**13. How long is the warranty period?**

One year from the original date of purchase. We will gladly offer repair or replacement for all defective units.

**14. What is the correct jumper setting for using a single hard drive?**

Single master without slave. Most of HDD drives come with the jumper setting as a Master without slave, so you may not need to change the jumper setting after you purchase HDD and install it into DVR. Check the documentation that came with your hard drive.

**15. What is the largest hard drive that I can install in the DVR?**

This unit supports a SATA hard drive up to 500GB

**16. How can I erase all data on the hard disk drive?**

Select "HDD Format" option on the menu.

**17. Why do I need a password?**

You may need a password to format hard drive. The password is for your protection.

**18. I forgot my password. What should I do?**

Press the "STOP" button five times and it will reset the DVR settings to factory default.

Then the password will reset to factory default (111111). \*Channel 1 button is as same as a numeric number

**19. Can my desktop PC read the video data on hard disk drive in DVR?**

Yes, MS-Windows can detect HDD but cannot recognize the file system. You must use a PC application (i.e. PC Viewer) to view the video image.

**20. What happens if I install my PC hard disk drive into the DVR?**

You can use a PC hard disk drive in the DVR. However, once it runs in DVR, it will delete Any PC operation system and files on the hard drive.

**21. What kind of hard drive should I purchase to make the DVR run?**

Any PC compatible SATA hard disk drive will work.

**22. Does this DVR kit come with sensors, cameras, or hard disk drive?**

Some models come with a hard disk drive and cameras. Some models don't. please check the package contents information on the DVR box. If the DVR unit that you've purchased contains a digital video recording system only, then you need to buy accessories separately to complete a digital video recording surveillance system. A single hard drive and a single camera are minimum requirements to make a digital surveillance system complete.

## Appendix

### Technical Specifications 4-Channel DVR

Items	Descriptions	
Video Standard	NTSC, PAL	
Video Input/Output	4 Channels/2 Channels	
Audio Input/Output	2 Channels/2 Channels	
Monitoring	Resolution	NTSC:720X480@30fps(Each Ch) PAL:720X576@25fps(Each Ch)
	Features	Full-D1,1-CH/4-CH Display
Recording	Resolution	NTSC:720X240@60fps(4Ch.Total) PAL:720X288@50fps(4Ch.Total)
	Features	Variable Frame Rate/Variable QL per Channel
	Quality	4-Level(Highest High Normal low)
Audio	ADPCM2 CODEC	
Video	MPEG4	
Motion Detection	Settable Window/Level	
Microprocessor	32-bit RISC Processor	
Network Interface	TCP/IP (RJ45)	
Network Monitor	IE (Internet Explorer)	
PTZ Interface	RS485	
USB Interface	USB 2.0	
VGA Output	Optional	
Remote control	IR remote control	
Power supply	DC 12V/5A	

Recording Time Table

(Per 160GB of storage with the installation of 4 cameras.)

Unit: Hour

Standard	Quality	60fps	48fps	32fps	16fps	1fps
NTSC	Highest	62	78	116	232	3720
	High	88	110	165	330	5280
	Normal	107	134	201	401	6420
	Lower	120	150	225	450	7200

Standard	Quality	50fps	36fps	24fps	12fps	1fps
PAL	Highest	64	89	133	267	3200
	High	90	125	188	375	4500
	Normal	110	153	229	458	5500
	Lower	123	171	256	513	6150

- The figures in the table above were estimated under ideal recording conditions and may vary from your actual recording situation.
- In the table above, multiply by 2 for recording hours with an 320 GB HDD and 3 for recording hours with a 500 GB HDD.
- The complexity of the image and the amount of motion recorded greatly influences the recording capacity of your hard drive (HDD). The higher the frames per second and the higher the video quality setting, the lower your HDD recording capacity will be. In the same manner, the lower the frames per second setting and the lower the video quality setting, the higher your HDD recording capacity will be.
- Note that the lower frame rate does not mean a lower video quality. The video quality remains the same whether the frames per second setting is set high or low. One frame per second is the same as taking a photo every second.
- NTSC:Max.60 fps, PAL:Max.50 fps

## Q-SEE Product Warranty

Thank you for choosing our products.

All of our products users have a conditional free warranty repair service for hardware within 12 months starting from purchase date, and a free exchange service within one month (valid for manufacturing defects). Permanent upgrading service is provided for the software.

### Liability Exclusions:

Any product malfunction, abnormalities in operation or damage caused by following reasons are not within the free service scope of our company. Please select payable service.

- (1) Equipment damage caused by improper operation
- (2) Improper environment and conditions in/on which the equipment operates, e.g., improper power, environment temperature, humidity and lightening strike etc. that cause equipment damage.
- (3) Damage caused by acts of nature: earthquake and fire etc.
- (4) Equipment damage caused by the maintenance of personnel not authorized by our company.
- (5) Product sold over 12 months ago.

In order to provide various services to you, please complete registration procedure after you purchase the product. Cut off or copy User's Information Card and fax or mail it to us after the card is filled in. You can also register the product by going to the [www.q-see.com](http://www.q-see.com) website and clicking on the Register link.

If you have questions:

### Contact Us:

#### Mailing Address:

**DPS Inc.**

8015 E. Crystal Dr  
Anaheim, CA 92807

#### Customer Service:

Phone: 877-998-3440 x 538

Email: [cs@dpsi-usa.com](mailto:cs@dpsi-usa.com)

#### Website:

<http://www.q-see.com>

#### Fax:

714-998-3509

#### Tech Support:

Phone: 877-998-3440 x 539

Email: [ts@dpsi-usa.com](mailto:ts@dpsi-usa.com)

### Customer Information Card

<b>User's Name</b>	<b>Mr./Mrs.</b>
<b>Company Name</b>	
<b>Postal Address</b>	
<b>Postal code</b>	
<b>Phone Number</b>	
<b>E-mail</b>	
<b>Model Number of Product</b>	
<b>Serial Number of Product</b>	
<b>Purchase Date</b>	
<b>Distributor</b>	

The material in this document is the intellectual property of our company.

No part of this manual may be reproduced, copied, translated, transmitted, or published in any form or by any means without our company's prior written permission.

1. Our products are under continual improvement and we reserve the right to make changes without notice. But no guarantee is given as to the correctness of its contents.
2. We do not accept any responsibility for any harm caused by using our product.
3. The product picture may differ from the actual product, which is only for your reference. The accessories will probably be different according to the different selling areas. For details of accessories, please refer to your local distributor.

Copyright reserved



## Free Manuals Download Website

<http://myh66.com>

<http://usermanuals.us>

<http://www.somanuals.com>

<http://www.4manuals.cc>

<http://www.manual-lib.com>

<http://www.404manual.com>

<http://www.luxmanual.com>

<http://aubethermostatmanual.com>

Golf course search by state

<http://golfingnear.com>

Email search by domain

<http://emailbydomain.com>

Auto manuals search

<http://auto.somanuals.com>

TV manuals search

<http://tv.somanuals.com>