

Features of the WL3082

- Extraordinarily compact (only 20" / 508 mm wide) and lightweight (38 lb / 17.2 kg)
- High acoustic output (133 dB SPL peak)
- Wide 140° horizontal coverage
- High power, 8" neodymium LF/MF drivers provide low-frequency extension to 62 Hz without subwoofers
- 3" diaphragm compression driver on QSC's patented 140° multiple diffraction aperture waveguide (*Patent No. 7,177,437*)
- Simple, easy-to-use rigging system supports arrays of up to 12 units with 10:1 design factor
- Flexible ground stack capability
- Fully supported in EASE and EASE Focus acoustic software

Features of the WL212-sw

- Dual 12" subwoofer in a 4th order bandpass enclosure
- 135 dB SPL peak output capability
- Frequency range to 32 Hz (-10 dB down point)
- May be suspended at the top of a WL3082 array or behind the array
- Integral suspension hardware also supports WL3082 in ground stack applications

Designed for the most demanding concert and installation audio professionals, the WideLine-8 system sets new standards for astonishing acoustical performance and compact size.

Line arrays are increasingly employed in a wider range of venues and applications. Frequently these venues have height or sightline restrictions that limit the placement and size of the array. Rising fuel costs are putting pressure on touring system providers to downsize their transportation requirements. At the same time, client and audience expectations for audio performance has never been higher. To meet these needs, QSC embarked on a program to develop the most compact, highest output line array speaker system available.

QSC's WideLine-8 packs full size line array performance into an ultra compact package measuring less than 20" (508 mm) wide and 9" (229 mm) high. The WideLine-8 applies to audio the classic hot rod, high-performance formula – putting the most horsepower available into the smallest chassis possible.

Each tri-amplified WideLine-8 element uses a pair of high-power, neodymium magnet, 8" low-frequency drivers. Both cover low frequencies while only one extends into the mid range, thus maintaining horizontal dispersion control at crossover. High frequencies are handled by a premium, 3" diaphragm, neodymium compression driver mounted to QSC's patented, 140° multiple aperture diffraction waveguide. WideLine signature wide coverage delivers a broader stereo image, reduces the need for supplemental fill speakers and allows more placement options.

The waveguide exit extends nearly to the top and bottom of the enclosure to create a continuous acoustical source with minimal discontinuities between adjacent elements resulting in greatly reduced destructive interaction.

WL3082 | WL212-sw



The WideLine-8 sub sets a new benchmark for extraordinary acoustic output from a miniscule enclosure. At first glance, the enclosure seems too small to even house its pair of 4" voice-coil, long-excursion 12" woofers, yet it produces 135 dB (peak) SPL and has LF extension to 32 Hz, with the punch needed for popular music. The extremely low profile of the WL212-sw sub (less than 15") also makes it a great choice for installed and portable use under a stage or in other tight quarters. The 4th order bandpass design matches the width of the WideLine-8 elements allowing it to be flown inline with or behind a WideLine-8 array.

Premium materials are used throughout the system. The enclosure is constructed of Baltic birch plywood and coated in an environmentally friendly, waterborne polymer finish that is field repairable. To keep the weight to a minimum and prevent rust, suspension fittings are made of aluminum.

An elegantly simple 4-point suspension system combined with light weight, compact size and excellent handling ergonomics mean that a one person crew can easily deploy an array. A single AF3082-L array frame suspends up to twelve line array elements or up to twelve line array elements plus four subwoofers. The WideLine-8 system is equally at home in the air or ground-stacked.

Special attention is given to ground-stacked applications. The WideLine-8 sub suspension system includes a unique provision that allows the lowest line array element stacked over a sub to be tilted up or down by as much as 10°, offering better coverage of listeners near the stage. WideLine-8 subs may be used as a base for stacking up to six WideLine-8 elements.

WideLine-8 System Configurations

Flexible Arrays

Arrays can be assembled using only WL3082 line arrays modules, with WL212-sw subwoofers at the top of the array, or by utilizing the EB3082 extension bar, subwoofers can be flown behind the main array.

Arrays of up to twelve WL3082 modules, with four WL212-sw subwoofers flown behind can be accommodated by the combination of 2 x AF3082-S small array frames and a single EB3082 extension bar (Figure A). As many as twelve WL3082 modules can be suspended

using one AF3082-S (Figure B) while the AF3082-L large array frame can be used to assemble arrays of up to 12 x WL3082 modules alone or suspended below up to 4 x WL212-sw subwoofers (Figure C). The AF8-10 adapter frame (not shown) allows the user to add WL3082 WideLine-8 arrays beneath WL2012 WideLine-10 arrays. The PB3082 pullback bar (not shown) can be used to attain extra down-angle in flown arrays or as a suspension bar for arrays of up to eight WL3082 modules.



Figure C



Figure A



Figure B

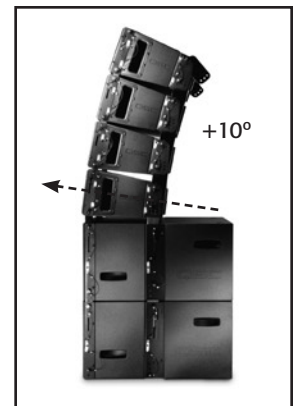
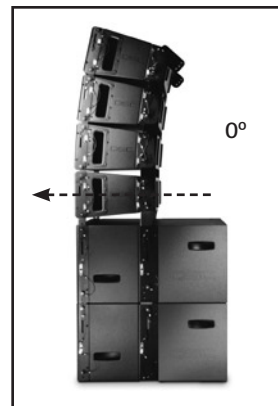
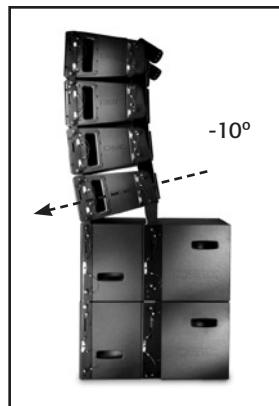

Optimized Ground Stacking

WideLine-8 rigging doubles as an optimized ground stacking system. Using the WL212-sw subwoofer as a base, arrays of WL3082 line array elements can be aimed downward by as much as ten degrees to cover audience areas close to a stage, as well as upward by as much as ten degrees in order to better cover distant balcony seating areas.

	WL3082	WL212-sw
Configuration	Dual 8", 3-way, tri-amp line-array	Dual 12", 4th order bandpass subwoofer
Transducers	High-frequency Low-frequency	3" diaphragm, neodymium magnet compression driver Dual, 8" woofer, 2.5" voice coil
Frequency Response (± 3 dB)	68 Hz – 18 kHz	40 Hz – 100 Hz
Frequency Range (-10 dB)	62 Hz – 20 kHz	32 Hz – 107 Hz
Nominal Impedance	HF: 16 Ω MF: 16 Ω LF: 16 Ω	SUB: 4 Ω
Continuous Power Capacity ¹	HF: 85 W MF: 250 W LF: 250 W	LF: 1100 W
Sensitivity (1 W at 1 m)	HF: 108 dB SPL MF: 98 dB SPL LF: 98 dB SPL	LF: 99 dB SPL
Maximum Output, Continuous/Peak (dB SPL at 1 m)	HF: 127 dB SPL / 133 dB SPL MF: 122 dB SPL / 128 dB SPL LF: 122 dB SPL / 128 dB SPL	LF: 129 dB SPL / 135 dB SPL
Nominal Coverage	H: 140° V: dependent on number of elements used	– –
Enclosure Type	Ported, trapezoidal	4th order bandpass
Enclosure Material	15 mm birch plywood	15 mm birch plywood
Finish	Available in black (WL3082) or white (WL3082-WH) paintable	Available in black (WL212-sw) or white (WL212-sw-WH) paintable
Grille	Perforated, 16AWG steel, backed with black/white cloth fabric	–
Connectors	2 x NL8 in parallel	2 x NL8 in parallel
Pin Outs	1+/1- NC; 2+/2- LF; 3+/3- MF; 4+/4- HF	1+/1- Sub; 2+/2- NC; 3+/3- NC; 4+/4- NC
Attachment Points	Integral, side plate adjustable rigging system, vertical splay adjustable in 1° increments from 0° – 10°	Integral, non-adjustable
Weight (Net / Shipping)	38 lb (17 kg) / 45.5 lb (20.7 kg)	109 lb (49.4 kg) / 125 lb (56.7 kg)
Dimensions (HWD)	9" x 20" x 16" 229 mm x 508 mm x 406 mm	15" x 20" x 29" 381 mm x 508 mm x 737 mm
Available Accessories <i>See descriptions on back</i>	AF3082-S • AF3082-L • EB3082 • CP3082 • PB3082 • AF8-10	AF3082-L • CP212 • AF3082-S

1) 2 hours, IEC specified noise

Specifications subject to change without notice.

WideLine-8 Signal Processing

The WL3082 is designed for tri-amplification. Adding WL212-sw subwoofers creates a 4-way active system. For applications in which audio quality is paramount but operational simplicity and low-cost are also critical, the QSC SC28 processor delivers factory programmed voicings while also offering user-adjustable system equalization, offset delays and output levels.

QSC system engineers have employed the power of the SC28 processor's FIR (finite impulse response) filters to implement Intrinsic Correction™ of the loudspeaker. *Intrinsic Correction* provides the most accurate acoustical magnitude, frequency and phase domain performance possible. *Intrinsic Correction* can compensate for many causal phenomena such as the effects of waveguide acoustical impedance and loudspeaker cone resonance. The result is a loudspeaker system with excellent power

response and extremely natural, uncolored sound across its frequency band and coverage area. An array of loudspeakers with *Intrinsic Correction* tunings will be very responsive to the use of equalization to compensate for array configuration, acoustical conditions or user preferences. For users needing sophisticated, programmable DSP, voicings are available for QSC BASIS™ processors.



SC28



BASIS 914z

WideLine-8

Dimensions | Accessories

WL3082

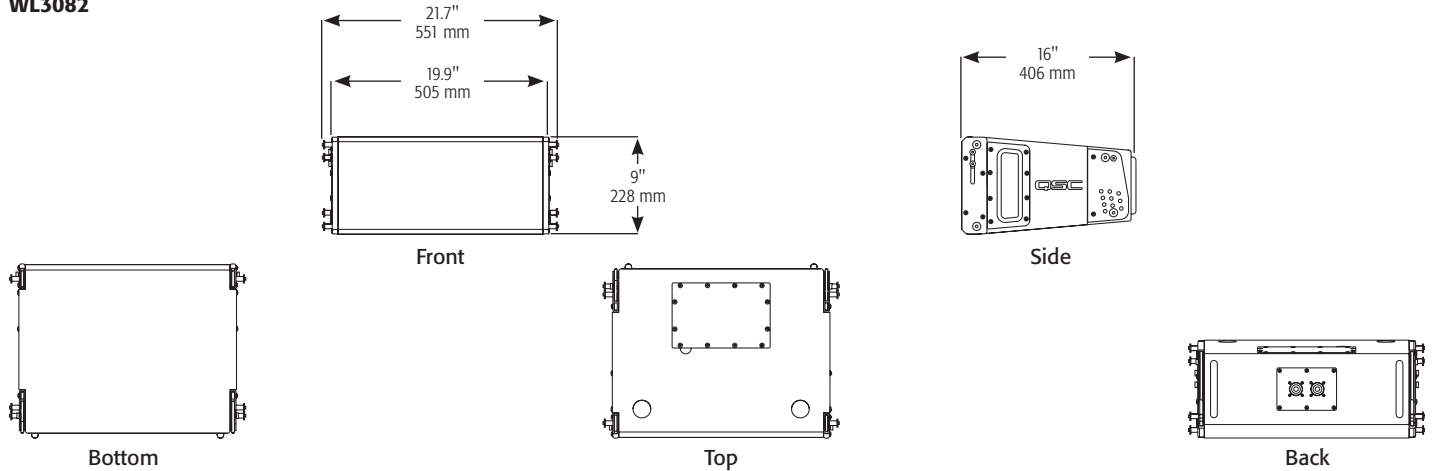

WL212-sw

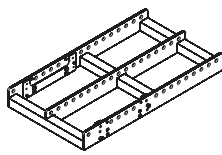
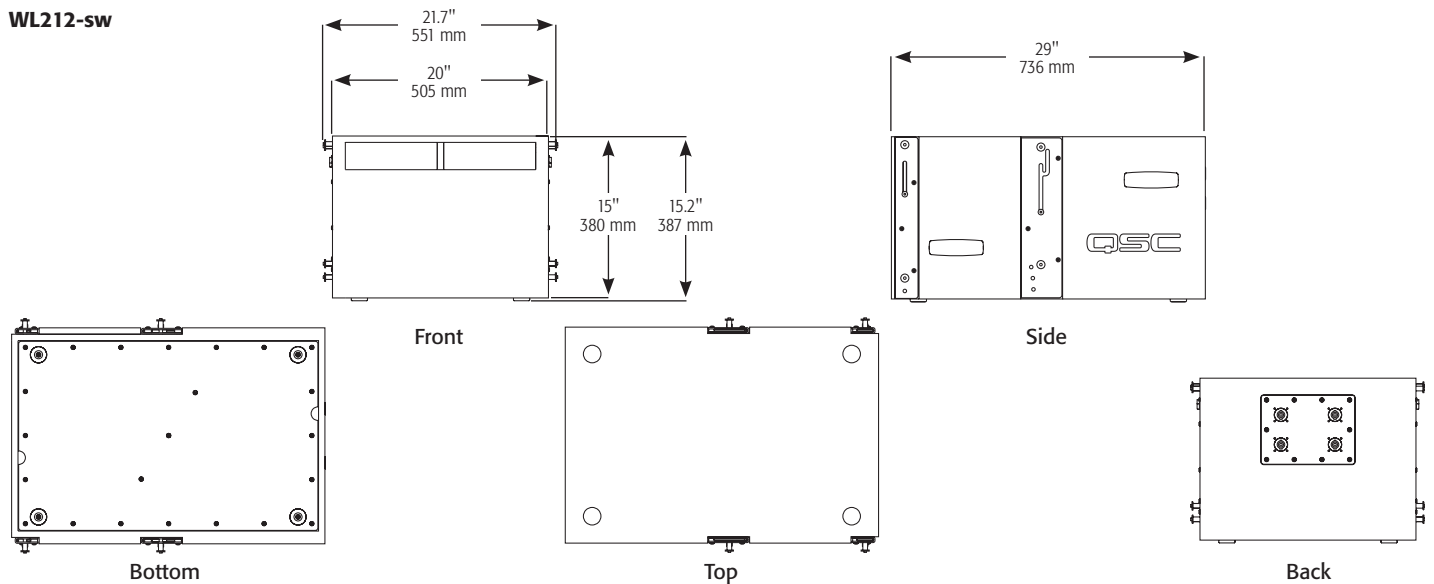

AF3082-L

Large array frame, supports up to twelve (12) WideLine-8 elements and four (4) WideLine-8 subs with 10:1 design factor.

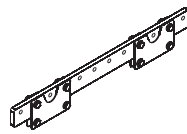

EB3082

Extension bar, required for system with the subwoofers flown behind the main array.

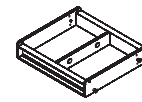

AF3082-S

Small array frame, supports up to twelve (12) WideLine-8 elements with 10:1 design factor.

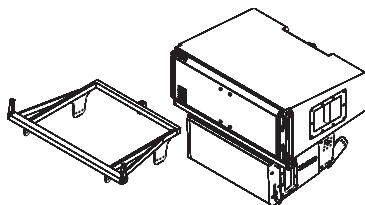

AF8-10

Adapter frame that allows suspension of WL3082 under WL2012.

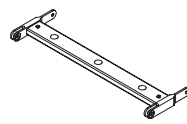

PB3082

Pullback bar for adjusting aiming angle of WideLine-8 arrays or suspension of certain small arrays.

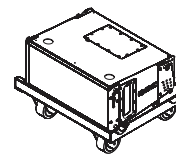

CP3082

Caster pallet for four (4) WL3082 line array elements, includes padded cover.

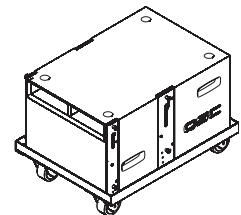

CP212

Caster pallet for three (3) WL212-sw subwoofers, includes padded cover.

Specifications subject to change without notice.

© 2009 QSC Audio Products, LLC. All rights reserved. QSC, the QSC logo, WideLine and BASIS are registered trademarks of QSC Audio Products, LLC in the U.S. Patent and Trademark office and other countries. Intrinsic Correction is a trademark of QSC Audio Products, LLC. All other trademarks are the property of their respective owners. Patents may apply or be pending.

1675 MacArthur Boulevard • Costa Mesa, CA 92626 • Ph: 800/854-4079 or 714/957-7100 • Fax: 714/754-6174

WideLine-8 Spec Sheet 05/26/09

QSC
qscaudio.com

Free Manuals Download Website

<http://myh66.com>

<http://usermanuals.us>

<http://www.somanuals.com>

<http://www.4manuals.cc>

<http://www.manual-lib.com>

<http://www.404manual.com>

<http://www.luxmanual.com>

<http://aubethermostatmanual.com>

Golf course search by state

<http://golfingnear.com>

Email search by domain

<http://emailbydomain.com>

Auto manuals search

<http://auto.somanuals.com>

TV manuals search

<http://tv.somanuals.com>