

QUAD

909
909 Mono

Power Amplifiers



Owner's Manual

Quad Electroacoustics Ltd, IAG House,
Sovereign Court, Ermine Business Park,
Huntingdon PE29 6XU
www.quad-hifi.co.uk
Tel: 01480 447700 Fax: 01480 431767

IMPORTANT SAFETY INFORMATION

- Read these instructions.
- Keep these instructions.
- Heed all warnings.
- Follow all instructions.
- Do not use this apparatus near water.
- Clean only with dry cloth.
- Do not block any ventilation openings.
- Install in accordance with the manufacturer's instructions.
- Do not install near any heat sources such as radiators, heat registers, stoves, or other apparatus (including amplifiers) that produce heat.
- Do not defeat the safety purpose of the polarized or grounding type plug. A polarized plug has two blades with one wider than the other. A grounding type plug has two blades and a third grounding prong. The wider blade or the third prong are provided for your safety. If the provided plug does not fit into your outlet, consult an electrician for replacement of the obsolete outlet.
- Protect the power cord from being walked on or pinched, particularly at plugs, convenience receptacles, and the point where they exit from the apparatus.
- Use only attachments/accessories specified by the manufacturer.
-  Use only with a cart, stand, tripod, bracket, or table specified by the manufacturer, or sold with the apparatus. When a cart is used, use caution when moving the cart/apparatus combination to avoid injury from tip-over.
- Unplug this apparatus during lightning storms or when unused for long periods of time.
- Refer all servicing to qualified service personnel. Servicing is required when the apparatus has been damaged in any way, such as power-supply cord or plug is damaged, liquid has been spilled or objects have fallen into the apparatus, the apparatus has been exposed to rain or moisture, does not operate normally, or has been dropped.
- Warning: To reduce the risk of fire or electrical shock, do not expose this product to rain or moisture. The product must not be exposed to dripping and splashing and no object filled with liquids such as a vase of flowers should be placed on the product.
- No naked flame sources such as candles should be placed on the product.
- Caution: Changes or modifications not expressly approved by the manufacturer could void the user's authority to operate this device.
- Warning: The mains power switch for this appliance is located on the rear panel. To permit free access to this switch, the apparatus must be located in an open area without any obstructions.

MAIN SERVICE CENTRES IN THE UK, USA AND CANADA

USA

IAG America, Inc.
 15 Walpole Park South
 Walpole
 MA 02081
 Tel: +1 508 850 3950



CANADA

Karbon Trading Ltd
 6800 Kitimat Road
 Units 19-20
 Mississauga
 Ontario
 Tel: +1 905 567 1920

U.K.

QUAD Electroacoustics Ltd.
 IAG House, Sovereign Court,
 Ermine Business Park,
 Huntingdon,
 Cambs PE29 6XU,
 England.
 Tel: +44 (0)1480 447700
 Fax: +44 (0)1480 431767

www.quad-hifi.co.uk

	CAUTION! RISK OF ELECTRIC SHOCK DO NOT OPEN	
<p>TO REDUCE THE RISK OF ELECTRIC SHOCK DO NOT REMOVE COVER (OR BACK) NO USER-REMOVEABLE PARTS INSIDE REFER SERVICING TO QUALIFIED PERSONNEL</p>		
<p>ADVERTISSEMENT: RISQUE DE CHOC ELECTRIQUE- NE PAS OUVRIR</p>		



This symbol indicates that there are important operating and maintenance instructions in the literature accompanying this unit.



This symbol indicates that dangerous voltage constituting a risk of electric shock is present within this unit.

SPECIFICATIONS

Quad 909 Stereo Amplifier

(Measurements made with 230V supply, one channel driven and apply to either channel)

Power Output	140W into 8 Ohms (0.05% THD)
Total Harmonic Distortion (100W/8Ω 20Hz - 20kHz)	<0.01%
Output Impedance	0.05Ω in parallel with 1.5uH
DC Offset Voltage	<10mV
Frequency Response	-1.0 dB at 13 Hz and 40 kHz, ref. 1kHz
Power Response	-0.25 dB at 20 Hz and 20 kHz, ref. 1kHz
Input Sensitivity	775 mV (RCA line input)
Input Impedance	20 kΩ
Crosstalk	-90 dB at 1 kHz (input loaded with 600Ω)
Signal to Noise Ratio (ref. 140 Watts)	108 dB (20 kHz measurement bandwidth)
Stability	Unconditional with any load and input
Dimensions (W x H x D)	321 x 140 x 240 (plus connectors)
Weight	12 Kg (nominal)

Quad 909 Mono Amplifier

Power Output	300W into 8 Ohms (0.05% THD)
Total Harmonic Distortion (100W/8Ω 20Hz - 20kHz)	<0.01%
Output Impedance	0.05Ω in parallel with 1.5uH
DC Offset Voltage	<10mV
Frequency Response	-1.0 dB at 13 Hz and 40 kHz, ref. 1kHz
Power Response	-0.25 dB at 20 Hz and 20 kHz, ref. 1kHz
Input Sensitivity	775 mV (RCA line input)
Input Impedance	20 kΩ
Signal to Noise Ratio (ref. 140 Watts)	108 dB (20 kHz measurement bandwidth)
Stability	Unconditional with any load and input
Dimensions (W x H x D)	321 x 140 x 240 (plus connectors)
Weight	12 Kg (nominal)



The right is reserved to alter all performance and specifications as required

QUAD



909 909 Mono USER GUIDE

CONTENTS

IMPORTANT SAFETY INFORMATION	IFC 
USER INFORMATION	2
INTRODUCTION	4
PROHIBITIONS ON HEADPHONE USE, ETC. (909 MONO) .	4 
PACKING LIST AND UNPACKING THE EQUIPMENT	5
INSTALLATION	5
MAINS SUPPLY AND SAFETY	5
CONNECTORS AND CABLES	7
QUAD 909 CONNECTIONS	8
QUAD 909 MONO CONNECTIONS	10
OPERATING YOUR EQUIPMENT	11
SPECIFICATIONS.	12
SERVICE ADDRESSES	IBC

Quad 909 Mono Connections

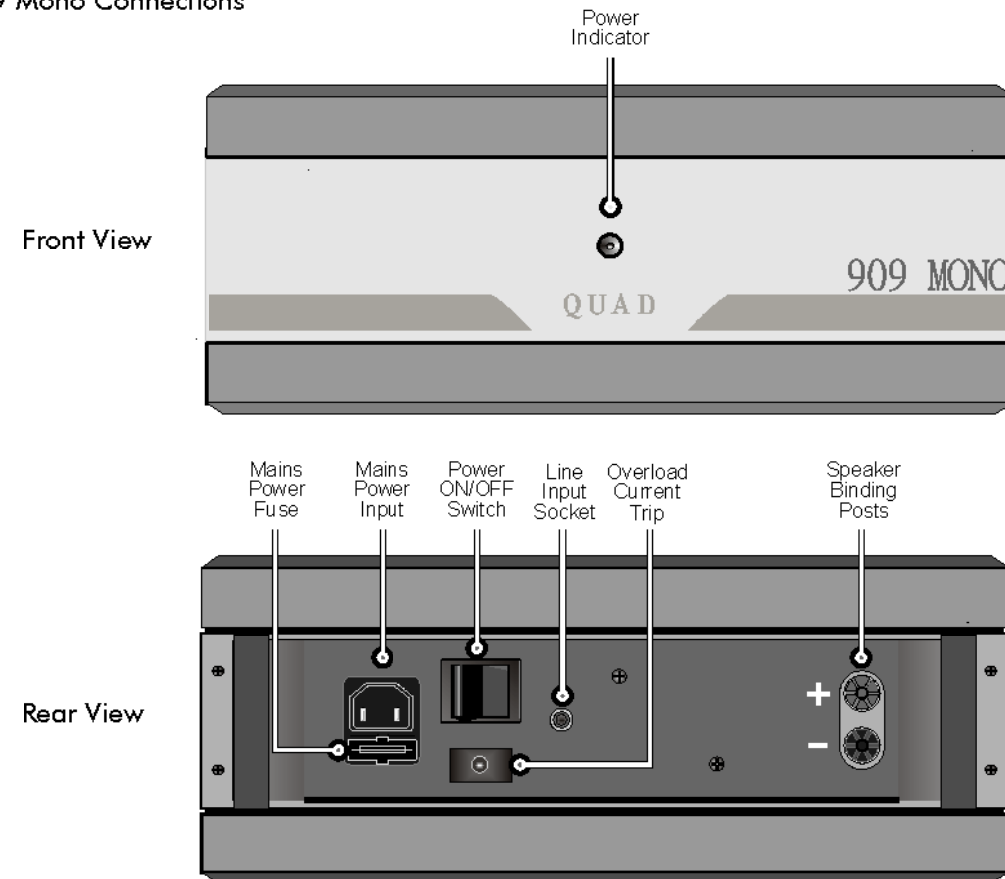

Connecting the Quad 909 Mono

The Quad 909 Mono does not utilise the AMPBUS system. Connect the outputs of your pre-amplifier to the RCA signal inputs of the 909 Mono as shown. Ensure the Left and Right channels are correctly connected. When connecting speakers, make sure that the Red + terminals of each loudspeaker connect to the Red+ sockets of the corresponding 909 Mono amplifier, and that the Black-sockets are similarly connected. The amplifiers may be placed as shown or side by side for improved ventilation.

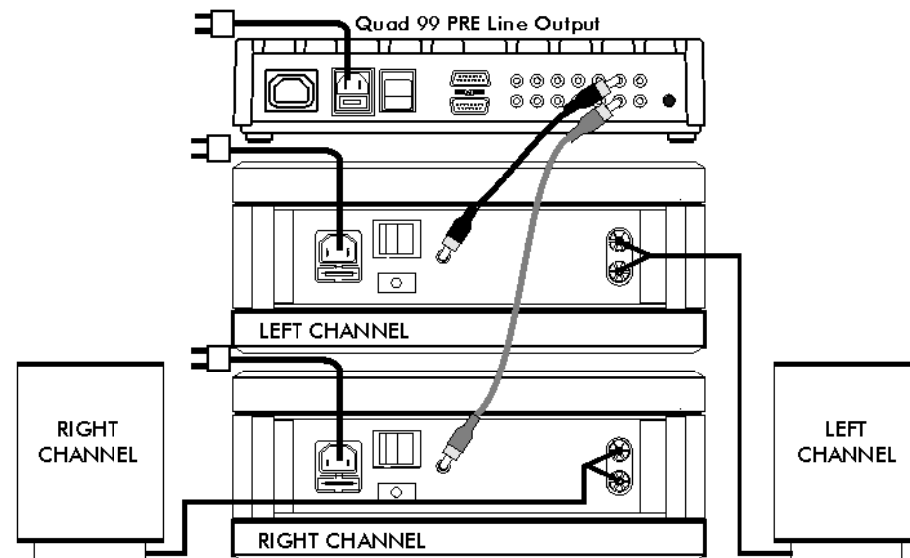

INTRODUCTION

The Quad 909 series power amplifiers are primarily intended for use with very high quality sound reproducing systems in the home and we hope that they will give you much pleasure. The amplifiers will normally be used in conjunction with a Quad pre-amplifier though other pre-amplifiers can be used.

You should read the following useful notes before you begin to install and use the equipment. The notes are directed towards responsible adults who can ensure safe installation of the equipment. Minors should not attempt electrical installation or carry out changes.

Quad 909 amplifiers weigh approximately 12kg each and are built to be robust. Remember to check that any surface on which you place it is stable and is able to support this weight.

There are no user adjustable parts inside the equipment. You should refer any servicing to a qualified engineer or return the equipment to either the dealer or the Quad distributor.

Current Dumping

909 series amplifiers use a current dumping output circuit, a Quad invention (covered by patents in several countries) which eliminates many of the problems associated with transistor amplifiers. In a current dumping amplifier there is in effect both a low power, very high quality amplifier and a high power, heavy duty amplifier. The low power amplifier controls the loudspeakers at all times calling on the high power amplifier to provide most of the muscle. The low power amplifier is so arranged - it carries an error signal - that provided the larger power transistors (the current dumpers) get within the target area of the required output current, it will fill in the remainder accurately and completely. The reproduced quality is solely dependent on the small amplifier which, because of its low power, can be made very good indeed.

Problems of crossover distortion, quiescent current adjustment, thermal tracking and transistor matching all disappear. There are no internal adjustments or alignments and the choice of power transistor types is less restrictive.

The performance of Quad 909 series amplifiers is as accurate as it is possible to achieve by careful design, selection of components and rigorous test procedures.

Simplified Diagram of a current dumping amplifier

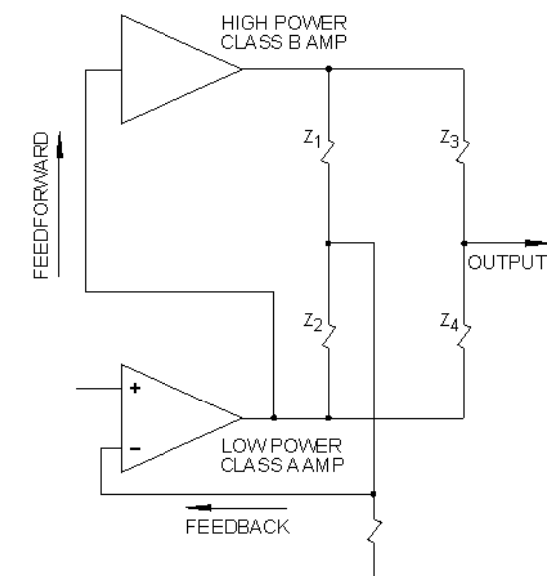

Quad 909 Connections

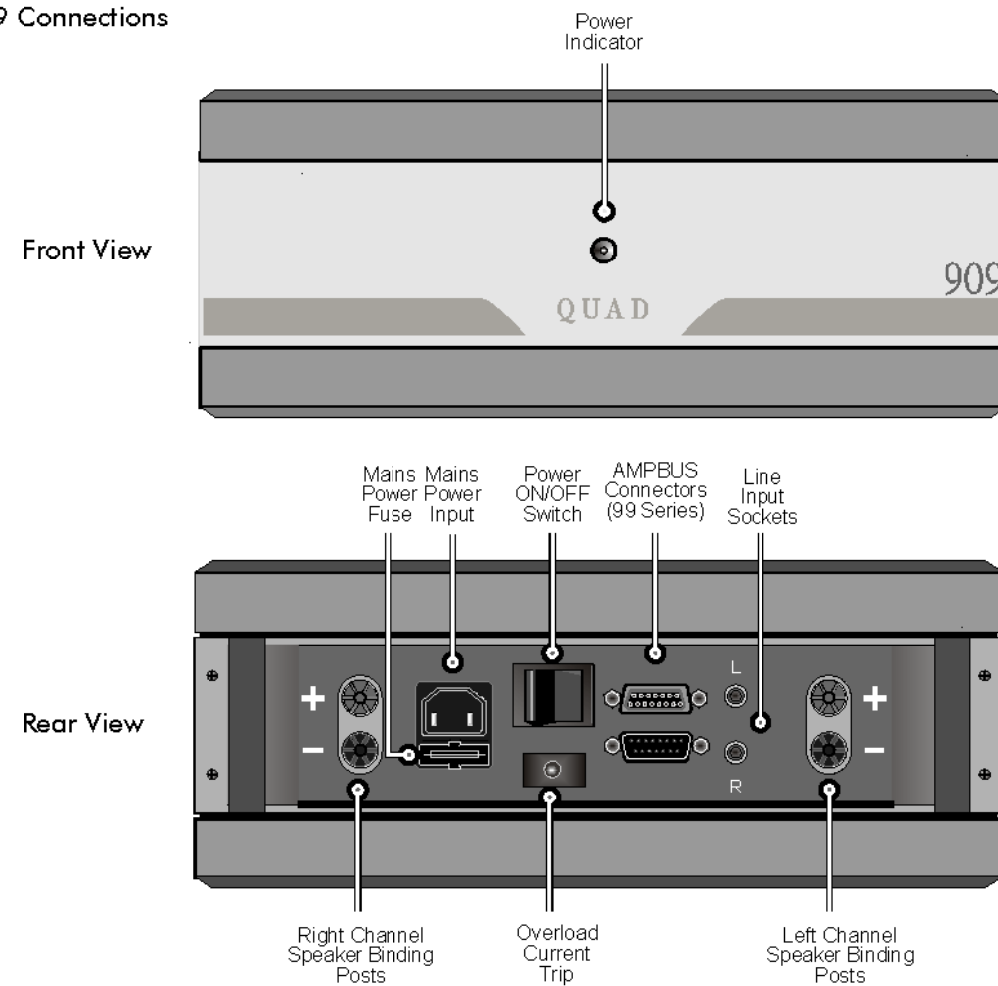

99 System Connections

The diagram shows the Quad 909 connected to some Quad 99 system components in a typical arrangement. The innovative bus system simplifies connections and provides optimal sound fidelity.

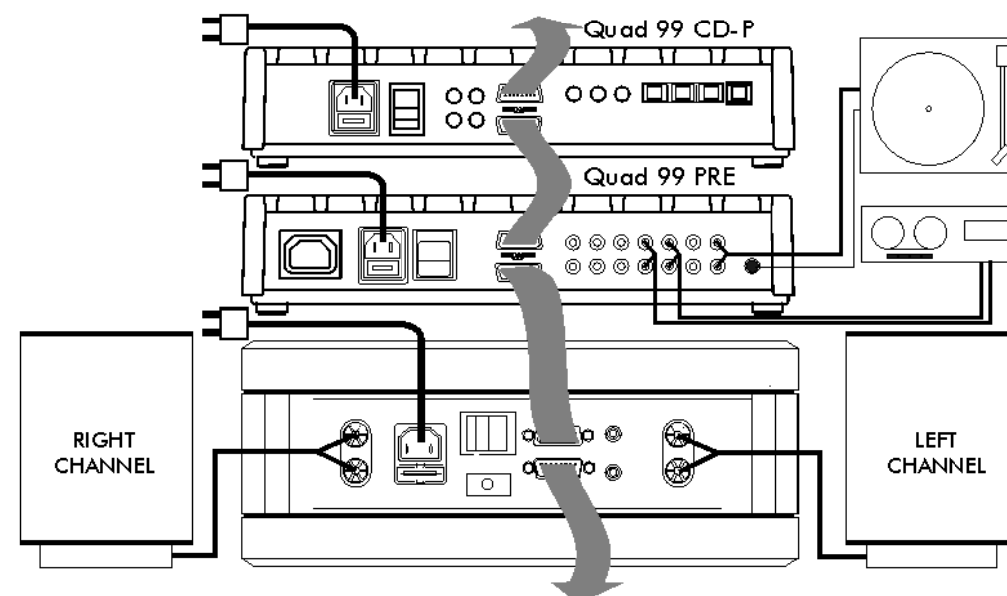

PACKING LIST AND UNPACKING THE EQUIPMENT

The packaging for all Quad 909 series products contains the following items:

- One 909 series Power Amplifier
- One IEC mains lead fitted with an appropriate mains connector;
 - for UK this is QUKES2B
 - for Europe this is QE2P2S2
 - for USA, Canada, Japan and Korea this is QU3ES2C
 - for other territories an appropriate cable will be supplied.
- Instruction Manual
- Warranty Registration Form
- One set of packing materials comprising:
 - One set of expanded foam end caps
 - One cardboard carton
 - One polythene protective bag

In addition the Quad 909 Stereo amplifier contains:

- One 1 m long 99 Ampbus connector and cable, Q37404A

Consult the dealer from whom you purchased the equipment if any of these items are not present.

Retain the packing materials for future use or return them to your dealer. If you decide not to keep the packing, please dispose of it sensibly. The paper and plastics are recoverable and may be taken to an appropriate recovery service.

Please retain the user manual and the information concerning the date and place of purchase of this equipment for future reference. If you decide transfer the equipment to a third party, please ensure all the instructions are passed on with the product.

INSTALLATION

Quad 909 series amplifiers have no controls other than an on/off switch. If used close to a record deck or other equipment susceptible to hum, it may be necessary to increase the spacing between those units and the power amplifier/s.

Quad 909 series amplifiers will be warm when running, the actual temperature depending on the power output. A resettable current trip will automatically switch the amplifier off under gross overload or short circuit output etc. The fins of the heatsink should be kept clear of obstruction to allow adequate ventilation in normal use.

See Amplifier Protection on page 11

Checking the AC power supply

909 series amplifiers are supplied in four versions suitable for connection to 230V, 220V, 115V or 100V AC power supplies. Before connecting the amplifier check that you have the correct version - if the amplifier is connected to a lower voltage than marked, the maximum output power will be lower than specified.

Before connecting to the AC power supply, check that the voltage range marked on the back corresponds with that of the supply. Within the EC, the nominal mains voltage is 230V AC.

Please check with the dealer if you have any doubt as to the voltage in your area or intend to use the equipment in regions which use different mains voltages.

Fuses

If you are in any doubt of the correct operational voltage, ask a qualified electrician before applying power to the equipment. The Quad 909 amplifier will work correctly within standard tolerances of this voltage.

The mains supply fuse of the Quad 909 amplifier is accessible on the rear panel after the IEC mains plug has been removed. In the rare event that it has broken, you should first check for any obvious cause before replacing the fuse with one of the correct rating and type. The correct fuse values are:

220 - 240V (UK, Korea, etc.) T 6.3 AL 20mm Slow Blow
100- 120V (USA, Japan, etc.) T 10 AL 20mm Slow Blow

You should switch off the equipment and remove the connection to the mains power outlet before changing the fuse.

Connecting to the AC power supply

Quad equipment supplied is provided with a mains cable fitted with an appropriate mains plug. This plug should not be cut from the cable. If, for any reason, the plug is removed, it must be safely disposed of. It must never be plugged into a mains outlet.

Any replacement plug should be wired to the supplied mains cable as follows:

the BROWN wire must be taken to the LIVE terminal

the BLUE wire must be taken to the NEUTRAL terminal

In the UK a fused 13 Amp mains plug should be fitted with a fuse link rated to 13 Amp which conforms to BS1362. In other countries a value between 10 Amps and 15 Amps should be used at either the wall socket or at the mains distribution board. If you are in any doubt you should consult a qualified electrical engineer.

Use of correct connectors and cables

You should ensure that any cables which are used with Quad equipment are properly terminated and that the cable is appropriate to the task. This is particularly important with loudspeaker cables and connections. If you are in any doubt you should consult your dealer.

Loudspeaker Cables

Loudspeaker cables should be carefully prepared. The following sketches show the preparation of a speaker cable for use with Quad power amplifiers and loudspeakers. When stripping the insulation, be careful not to cut into the wire. Make sure that you collect together all the strands of wire as stray wires may cause shorting which could result in damage or cause a fire.

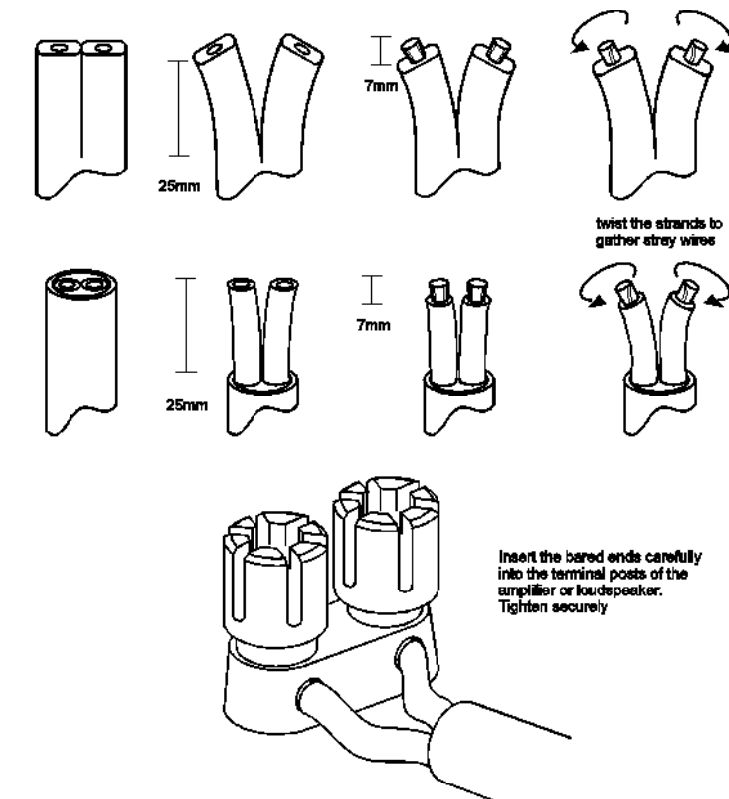

When estimating the length, provide sufficient loudspeaker cable to enable access and tidy securing. Some cable is quite heavy and you should be careful to place your cables so that they do not cause undue strain on the binding posts of the amplifier or loudspeaker.

Note: Ensure that cables used with Quad equipment are appropriate to the task and correctly terminated. For safety reasons Quad equipment is designed not to accept 4mm connectors.

Signal Cables

Signal cables should be properly terminated and fully screened to minimise hum. When the 909 amplifier is used as part of a Quad 99 system, you should use the 99 AMPBUS lead supplied to connect to the output of the 99 preamplifier or 99 AV processor. Signal on the 99 AMPBUS is in differential mode, which has performance advantages over conventional unbalanced signal connections.

When the 909 amplifier is used with other equipment, you should use an appropriate lead to connect to the phono input. Consult your dealer if in doubt.

The Quad 909

The Quad 909 is a versatile Stereo power amplifier that can be used with any high quality Stereo preamplifier, or integrated with the Quad 99 control unit and other components from the Quad 99 series to provide an integrated fully remote controlled versatile audio system.

The Quad 909 Mono

The Quad 909 Mono is a bridged monobloc version of the 909. By combining the two amplifier channels such that one channel amplifies the positive part of the signal waveform while the other amplifies the negative part, an extremely powerful dynamic amplifier can be obtained.

A conventional amplifier is shown in Figure A. The signal is amplified by the power amplifier and the loudspeaker is connected between the output terminal of the amplifier and the common signal return.

In a bridged amplifier the signal is fed through a splitter circuit which inverts the phase of the signal in one part of the splitter while leaving the phase unaltered in the other part. Each part of the splitter feeds its own power amplifier and the output signal is combined in the speaker which is fed equally from the outputs of both amplifiers. The basic technique is shown in Figure B

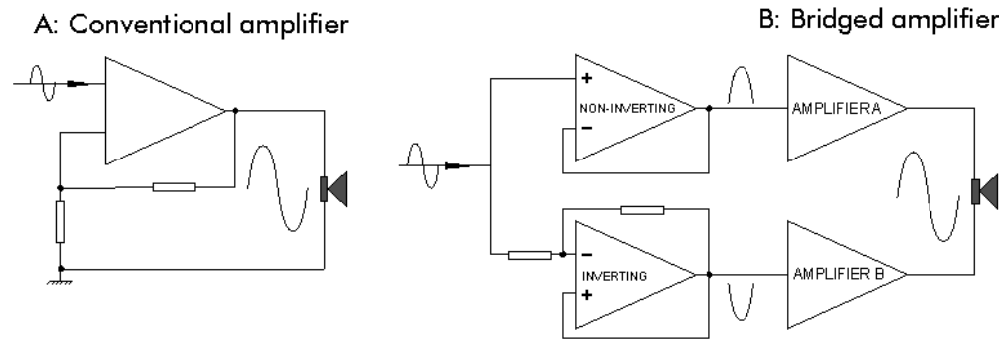

As the speaker forms a 'bridge' between the 'hot' amplifier output terminals, great care should be taken to ensure that no part of the loudspeaker or the loudspeaker connecting cables should be shorted or allowed to connect to ground at any point. Bridged amplifiers require a very high standard of design and execution. Quad's 'Current Dumping' circuitry ensures total accuracy between both 'halves' of the amplifier and stability is unconditional even with the most difficult loads.

Important Note: Do NOT connect subwoofers, speaker switching units, headphones, or any device with 'common earth' connections to the speaker outputs of the Quad 909 Mono. Input connections are unaffected.

Quad Electrostatic Loudspeakers

909 series amplifiers are fully compatible with the Quad ESL-63, ESL-988 and ESL-989 loudspeakers. They should not be used with the earlier model ESL which could be damaged by signal peaks unless a protection circuit is fitted inside each loudspeaker - please contact Quad Electroacoustics for details.

Running In your amplifier

The performance of amplifiers tends to stabilise after a period of use due to a number of factors associated with the physical and chemical properties of the components. We recommend that the system be run with a music signal for several hours when it is first installed. Although the changes can be quite subtle, after a few days the sound quality becomes smoother and more natural.

Quadlink and Ampbus Cables

Two kinds of bus are used in the Quad 99 series. AMPBUS is the system linking the Power amplifiers to the Quad 99 preamp (and to each other in multiple amplifier arrangements). The 99 AMPBUS and QUADLINK cables are electrically and physically identical. Quad manufactures two lengths of the cable, 160mm and 1m. The ends are terminated with male and female D type 15 way connector.



Bi- and Tri-amplification

Two or more 909 amplifiers can be used in bi- or tri-amplified combinations, or combined with one or more 99 stereo amplifiers by simply linking them using Quad 99 AMPBUS cables. A bi-amplified arrangement is shown below.

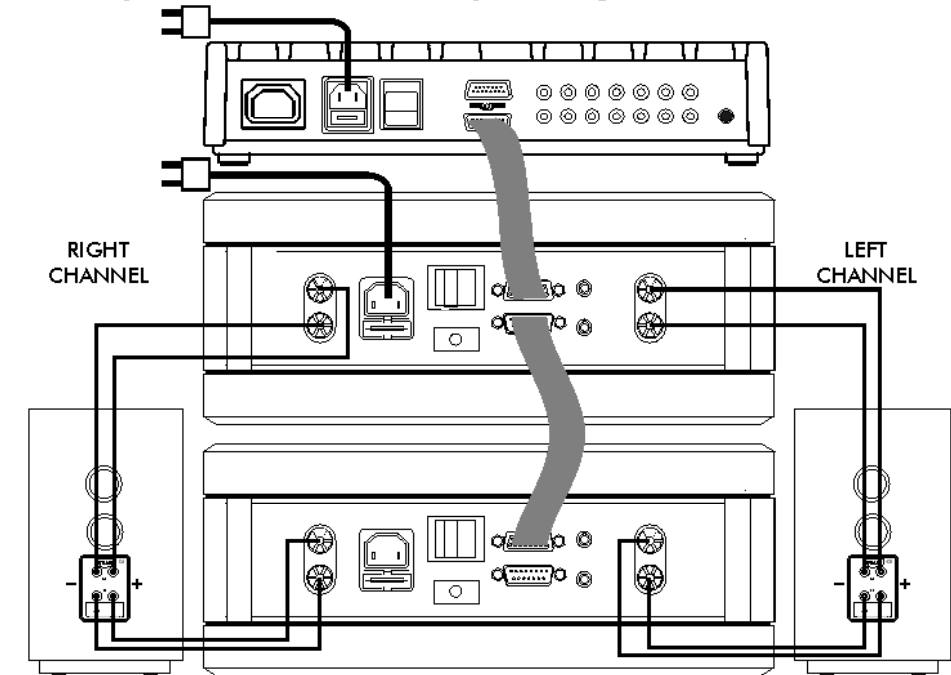

Connecting the Quad 909 to non-Quad 99 sources

Connect the outputs of your pre-amplifier to the RCA signal inputs of the 909 as shown. Ensure that the Left and Right channels are correctly connected.

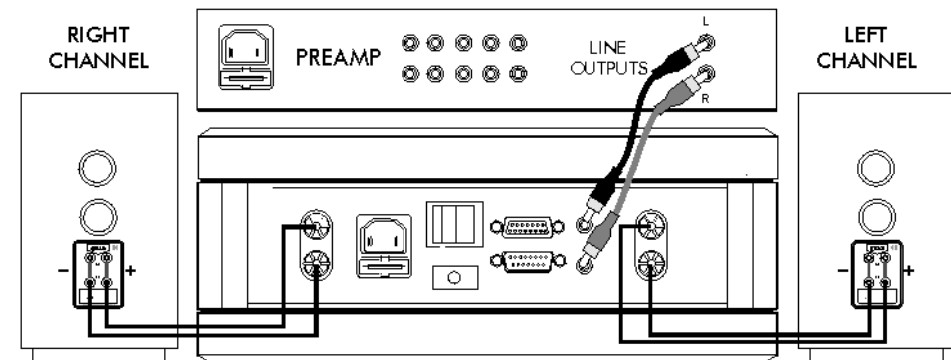

INFORMATION TO THE USER

Good Practice

It is always good practice to switch off equipment before connecting or disconnecting signal leads. This will prevent unpleasant and loud noises coming from the loudspeakers and avoid the risk of damage to equipment.

This equipment is double insulated and does not need a safety earth. It is important, though, that any equipment connected to it is earthed according to the manufacturers' instructions. This becomes more important as the number of units which are connected together increases.

Noise Pollution

Please be aware that very high sound pressure levels can cause permanent damage to your hearing and also severe annoyance to neighbours.

Guarantee and Product Registration

Your Quad equipment is guaranteed against any defect in material and workmanship for one year from the date of purchase (proof of purchase required). We ask that you complete and return the enclosed Warranty Registration Form. Within the guarantee period, Quad will undertake replacement of defective parts free of charge provided that the failure was not caused by misuse, accident or negligence. Your statutory rights within the territory in which you purchased the equipment are not affected by this guarantee.

Quad carries out a regular review of its products and reserves the right to adjust the specifications and performance from time to time.

There are no user replaceable or serviceable parts inside this equipment. Unauthorised attempts to service or modify this product will invalidate the warranty.

Service Arrangements

Equipment for servicing should be returned to the supplying dealer, or to the appointed service agents for your area. The addresses of Service Agents for the UK, USA and Canada are listed on the rear cover of this manual. If you are abroad and there is no suitable dealer in your area, please contact the distributor for the country in which it was purchased or Quad Electroacoustics Ltd.

Equipment returned for service should use the original packing. Please enclose a brief note with your name and address and the reason for returning the unit.

Compliance

Quad equipment is compliant with the relevant clauses enshrined in the following standards and directives in force at the time of the introduction of the product.

EU

Directives: 89/336/EC, 72/23/EEC

Safety: EN60065 (CB Scheme)

Emissions: EN55013, EN61000

Immunity: EN55020:2002.

The product bears the CE mark:



USA: UL 6500:2002.

CANADA: CAN/CSA-E60065-00

OPERATING YOUR EQUIPMENT

Switching On

The on/off switch has a rocker action; press the right hand side to switch the equipment on and the left hand side to switch it off.

909 Stereo: When the amplifier is part of a Quad 99 system using the special AMPBUS cable, this switch should normally be left switched on as the amplifier will be remotely switched from the 99 Preamplifier or the 99 system handset. The power LED will glow red when the amplifier is in standby and green when on.*

Where the 909 Stereo amplifier is not part of a Quad 99 system, the MAINS On/Off switch should be switched off when the amplifier is not in use.

909 Mono: The MAINS On/Off switch on both amplifiers should always be switched off when not in use.

Note: Always switch on the power amplifiers after the rest of the system and switch them off first. Ensure the system volume control is at minimum when switching your equipment on or off.

Amplifier Protection Trip

909 series amplifiers are protected by a resettable current trip which interrupts the AC Power supply if the amplifier is grossly overloaded for a period of time. To restore operation, simply press the red reset button on the back panel. It is thus fully protected against gross overload, short-circuited output etc, but not necessarily against seriously inadequate ventilation.

Loudspeaker Phasing

Make sure that both channels are connected in phase. The positive (red) output terminal of each channel should be connected to the positive (red) terminal of the speaker. Special care should be taken when bi-wiring as phase becomes critical.

If there is a doubt about the way the loudspeakers are connected, check their phasing by playing a mono source - the sound should appear from a point midway between the two loudspeakers. If this position is indefinite, reverse the connections to one of the loudspeakers. Correctly connected loudspeakers give a definite centre sound source with fuller bodied tenor and bass registers.

Headphones

909 Stereo: There are a number of suitable switch units available designed to enable the loudspeakers to be switched off when headphones are plugged in. Most of these incorporate a simple attenuator circuit to permit operation at normal settings of the control unit volume control.

909 Mono: Headphones should **NOT** be connected to the speaker outputs.

Maintenance

The surface of the equipment may be cleaned with a barely damp cloth provided the power has been switched off. Solvent based cleaners should not be used.

***Note:** Quad 909 amplifiers do not have a standby state. They are either on or off. Because the Quad 99 pre-amplifier *does* have a standby state, when the 99 Pre is connected to the 909 stereo amplifier using the QUADLINK system, the power indicator on the 909 amplifier mimics the rest of the system and indicates *green* for operational, and *red* when the Quad 99 Pre is in standby.

If a Quad 909 (mono or stereo) is connected via the RCA phono inputs, no 'standby' signal can be sent to the amplifier so the indication will be *green* as long as the unit is switched on whether the connected source units are in standby or not.

Free Manuals Download Website

<http://myh66.com>

<http://usermanuals.us>

<http://www.somanuals.com>

<http://www.4manuals.cc>

<http://www.manual-lib.com>

<http://www.404manual.com>

<http://www.luxmanual.com>

<http://aubethermostatmanual.com>

Golf course search by state

<http://golfingnear.com>

Email search by domain

<http://emailbydomain.com>

Auto manuals search

<http://auto.somanuals.com>

TV manuals search

<http://tv.somanuals.com>