



**QUALCOMM Globalstar
GIK-1700 Globalstar
Installation Kit
User Guide**



This guide is based on the production version of the QUALCOMM Globalstar GIK-1700 Globalstar Installation Kit. Software changes may have occurred after this printing.

QUALCOMM reserves the right to make changes in technical and product specifications without prior notice.

QUALCOMM Incorporated
5775 Morehouse Drive, San Diego, CA 92121-1714
Document Number 80-C6303-1 Rev B

Copyright © 2006 QUALCOMM[®] Incorporated
All rights reserved

This technology was exported from the United States Government. Diversion contrary to U.S. law prohibited.

QUALCOMM[®] is a registered trademark of QUALCOMM Incorporated.
Digital by QUALCOMM[®] is a registered trademark of QUALCOMM Incorporated.
SMART KEY[™] is a trademark of QUALCOMM Incorporated.
Globalstar[™] is a trademark of Globalstar, Inc.

All other trademarks and registered trademarks are the property of their respective owners.

Printed in the United States of America



Table of Contents

Introduction	1
Features	1
Safety precautions	1
Exposure to radio frequency signals	2
Antenna care	3
Phone operation	3
Driving	4
Electronic devices	4
Pacemakers	5
Hearing aids	5
Other medical devices	5
Vehicles	6
Posted facilities	6
Aircraft	6
Blasting areas	6
Potentially explosive atmospheres	7
For vehicles equipped with an air bag	7
Battery care	7
Other safety issues	8
Components	9
Globalstar Installation Kit standard components	10
Component parts	11
Globalstar Installation Kit	11
Speaker	11
Hands-Free microphone	11
Power interface cable	11

Car stereo muting (STEREO MUTE)	12
Ignition sense	12
Car Power Adapter	13
Exterior antenna	13
Globalstar Installation Kit optional accessories	14
Optional accessories (not included in kit)	15
Privacy headset	15
Data cable	15
Operation	17
Using the phone in a vehicle	17
Attaching the phone to the Globalstar Installation Kit	17
Turning on the phone and GIK	18
Charging the phone battery	19
Car stereo mute	20
Hands-free mode	20
When you use hands-free mode	21
Adjusting speaker volume	21
Connecting to a personal computer	22
Privacy Headset	22
Privacy headset operation	22
Troubleshooting	25



Introduction

Before using your Globalstar Installation Kit in a vehicle, please read this manual thoroughly and retain it for future reference. Professional installation is recommended.

Features

The Globalstar Installation Kit (GIK) allows your Globalstar satellite phone to be used as a mobile phone in your vehicle.

With this kit installed in a vehicle, you can:

- Turn the phone on and off by turning the vehicle's ignition on and off.
- Talk without picking up the phone.
- Obtain unlimited talk time using DC current supplied by your vehicle.
- Charge the phone's battery.

Safety precautions

When using your phone in a vehicle, please observe the following rules.



Caution

Failure to follow these instructions may lead to serious personal injury and possible property damage.

- Secure the phone in your vehicle to prevent personal injury and damage to the phone in the event of an accident.

When attaching or detaching the exterior antenna to the GIK with the antenna cables, disconnect all power to the phone and the GIK. Note that DC voltage is present in the central conductor of the antenna cable (45-C6162-1). See Globalstar Installation Kit standard components, page 10.

- Detach the phone from the GIK and disconnect the power interface cable (45-C6184-1) to the GIK when jump starting the vehicle or recharging the car battery. Jump starting may cause the GIK fuse to open. Refer to the installation sheet for further information regarding interconnects.

Exposure to radio frequency signals

Your wireless handheld portable telephone is a low power radio transmitter and receiver. When it is on, it receives and also sends out radio frequency (RF) signals.

In August, 1996, the Federal Communications Commissions (FCC) adopted RF exposure guidelines with safety levels for hand-held wireless phones. Those guidelines are consistent with the safety standards previously set by both U.S. and international standards bodies:

- ANSI/IEEE C95.1-1999 Standard¹
- NCRP Report 86 (1986)²
- ICNIRP (1998)³

-
1. American National Standards Institute
 2. National Council on Radiation Protection and Measurements

■ IRPA (1991) Guidelines on Protection Against Non-ionizing Radiation¹

The phone and this kit are designed to comply with established ANSI, FCC, and international safety standards for safe levels of human exposure to RF energy. Nonetheless, RF field intensity at the surface of the transmitting antenna is fairly high. Maintaining a minimum line-of-sight separation distance of 25 cm (10 inches) between the transmitting antenna and all personnel will ensure that the General Population/Uncontrolled Exposure Maximum Permissible Exposure (MPE) limits are not exceeded. This satisfies the MPE limits mandated by the FCC in 47 CFR Ch. 1 (2006 Edition), Part 1, paragraph 1.1310 and defined in the ANSI/IEEE C95.1-1999 standard, and also satisfies the slightly more-stringent European and international exposure limit recommendations of IRPA (1991) and ICNIRP (1998).

Antenna care

Use only the supplied or an approved replacement antenna. Unauthorized antennas, modifications, or attachments could damage the phone and may violate FCC regulations.

Phone operation

Hold the phone as you would any other telephone with the antenna pointed up and over your shoulder.

3. International Commission on Non-Ionizing Radiation Protection
1. Internal Radiation Protection Association



Tip

For your phone to operate most efficiently:

- ❑ Extend your antenna fully.
- ❑ Do not touch the antenna unnecessarily when the phone is in use. Contact with the antenna affects call quality and may cause the phone to operate at a higher power level than otherwise needed.

Driving

In the areas where you drive, always obey the local laws and regulations on the use of wireless telephones.

If using your phone while driving, please:

- Give full attention to driving – driving safely is your first responsibility.
- Use hands-free operation, if available.
- Pull off the road and park before making or answering a call if driving conditions require you to do so.

Electronic devices

Most modern electronic equipment is shielded from RF signals. However, certain electronic equipment may not be shielded against the RF signals from your wireless phone.

Pacemakers

The Health Industry Manufacturers Association recommends that a minimum separation of six inches (15 cm) be maintained between a handheld wireless phone and a pacemaker to avoid potential interference with the pacemaker. These recommendations are consistent with the independent research by and recommendations of Wireless Technology Research.

Persons with pacemakers:

- Should ALWAYS keep the phone more than six inches from their pacemaker when the phone is turned on.
- Should not carry the phone in a breast pocket.
- Should use the ear opposite the pacemaker to minimize the potential for interference.
- If you have any reason to suspect that interference is taking place, turn your phone off immediately.

Hearing aids

Some digital wireless phones may interfere with some hearing aids. In the event of such interference, you may want to consult your service provider (or call the customer service line to discuss alternatives). *Optional for each phone manufacturer.*

Other medical devices

If you use any other personal medical device, consult the manufacturer of your device to determine if it is adequately shielded from external RF energy. Your physician may be able to assist you in obtaining this information.

Turn your phone off in health care facilities when any regulations posted in these areas instruct you to do so. Hospitals or health care facilities may be using equipment that could be sensitive to external RF energy.

Vehicles

RF signals may affect improperly installed or inadequately shielded electronic systems in motor vehicles. Check with the manufacturer or its representative regarding your vehicle. You should also consult the manufacturer of any equipment that has been added to your vehicle.

Posted facilities

Turn your phone off in any facility where posted notices require you to do so.

Aircraft

FCC regulations prohibit using your phone while in the air. Switch off your phone before boarding an aircraft.

Blasting areas

To avoid interfering with blasting operations, turn your phone off when in a “blasting area” or in areas posted: “Turn off two-way radio”. Obey all signs and instructions.

Potentially explosive atmospheres

Turn your phone off when in any area with a potentially explosive atmosphere and obey all signs and instructions. Sparks in such areas could cause an explosion or fire resulting in bodily injury or even death.

Areas with a potentially explosive atmosphere are often but not always clearly marked. They include fueling areas such as gasoline stations; below deck on boats; fuel or chemical transfer or storage facilities; vehicles using liquefied petroleum gas (such as propane or butane); areas where the air contains chemicals or particles, such as grain, dust, or metal powders; and any other area where you would normally be advised to turn off your vehicle engine.

For vehicles equipped with an air bag

An air bag inflates with great force. DO NOT place objects, including both installed or portable wireless equipment, in the area over the air bag or in the air bag deployment area. If in-vehicle wireless equipment is improperly installed and the air bag inflates, serious injury could result.

Battery care

The phone's battery stores a large amount of energy when fully charged. If the battery is punctured, crushed, severely overheated, or charged in a non-QUALCOMM charger, this energy can be released suddenly and result in potential injury.

- Do not overheat the battery by leaving it on a heater or in the sun.

Introduction

- Do not dispose of the battery in a trash compactor or incinerator.
- Use only charging accessories manufactured by QUALCOMM, and discontinue use of the battery if it becomes damaged.

Other safety issues

In order to avoid the potential for confusing the phone as a weapon, the phone features a distinctive flame orange dot on the top of the antenna.

- This orange dot is a convention used by manufacturers of various devices and is familiar to safety officers in the country of manufacture and other countries.
- Do not remove or cover the dot, and avoid using or handling the phone in a threatening manner or so as to suggest that the phone is a weapon.



Components

Check the components of the Globalstar Installation Kit listed below. If there is something missing, please contact the service provider where you purchased your kit.

Component parts

CV90-C6029-1	Globalstar Installation Kit
CV90-C6030-1	Speaker Installation Kit
80-C6061-1	Hands-Free Microphone
45-C6184-1	Power-Interface Cable
65-C6185-1	Hardware Kit
45-H3210-6	Speaker Extension Cable
50-C6045-1	Speaker Mounting Bracket
CV90-C6032-1	Car Power Adapter
45-C6162-1	Antenna Cable
65-C6056-1	Literature Kit
GIK-1750	Patch Antenna
GIK-1770	Quadri-filar Helix Antenna

Globalstar Installation Kit standard components

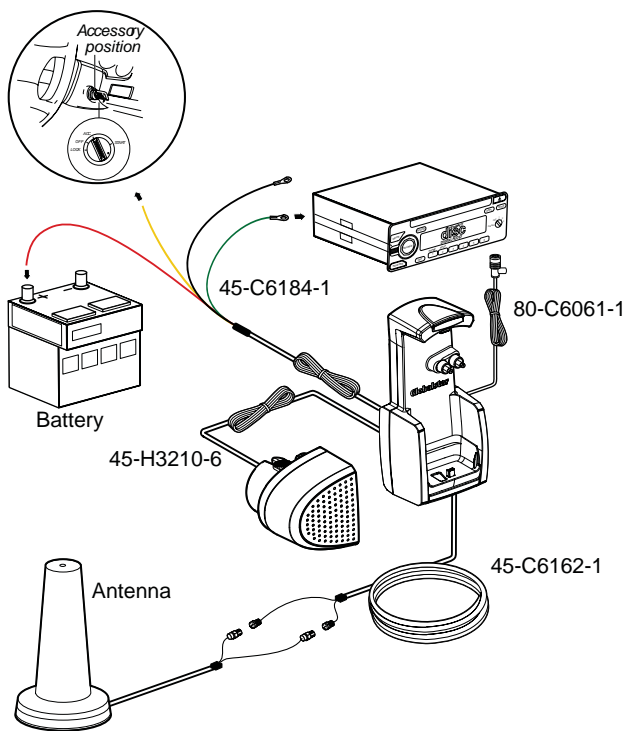

Component parts

Globalstar Installation Kit

The Globalstar Installation Kit (CV90-C6029-1) securely holds the Globalstar phone, interfaces to the vehicle's power, and houses the electronic circuit for the GIK. It provides and controls the supply voltages for the accessories and the charge current for the phone.

Speaker

The speaker (CV90-C6030-1) connects to the GIK speaker jack. It should be mounted at least 20 inches (50 cm) away from the Hands-Free microphone and should not be pointed towards the microphone. It can be mounted either on the cradle or remotely, depending on the user's preference.

Hands-Free microphone

The Hands-Free microphone (80-C6061-1), a unidirectional mouse-style microphone, connects to the GIK microphone jack. It can be installed with velcro or tape on the A-pillar or on the driver's sun visor.

Power interface cable

There are two options to connect to the car's power supply; the car interface cable and the Car Power Adapter.

The power-interface cable (45-C6184-1) connects to the GIK via the 4-pin connector.

Components

- The fused red lead connects to the positive terminal of the vehicle's battery.
- The black lead ground (GND) connects to a clean, unpainted metallic part of the vehicle.
- The fused green lead (STEREO MUTE) is for car stereo mute.
- The fused yellow lead (IGNS) is for ignition sense.

Car stereo muting (STEREO MUTE)

The phone provides a feature to mute the car stereo automatically during a conversation, which is convenient and provides for safer hands-free operation. When the phone rings, the green fused lead provided for the stereo mute feature goes to ground.



Note

This feature requires a car stereo that supports it.

Ignition sense

The ignition sense feature prevents the car kit from draining the vehicle's battery by executing an auto power off 30 seconds after the ignition key has been turned off, if not currently in a call. The yellow wire of the power-interface cable (45-C6184-1) is used for the ignition sense feature. The use of ignition sense is recommended to prevent accidental draining of the vehicle's battery. The wire is connected via a fuse to the vehicle's ignition.

Car Power Adapter

The GIK can alternatively be powered using the Car Power Adapter (CPA) (CV90-C6032-1).

- Connect the CPA cable to the 4-pin connector on the back of the unit.
- Plug the CPA into the vehicle's car power port.



Caution

Refer to vehicle's user manual regarding car power port operation. Some car power ports provide continuous power regardless of vehicle ignition state. This may require the user to remove the CPA from car power port to avoid vehicle battery drain when vehicle is off. When using the CPA, the stereo mute function is not available.

Exterior antenna

The exterior antenna permits communication with the satellite when the phone is installed in the GIK.

Antenna cables

The antenna cable consists of a pair of paired coaxial cables (45-C6162-1) that connect the exterior antenna to the GIK. Use only the antenna cables that come with your kit when connecting the exterior antenna. **Do not cut or modify the antenna cables.**



Caution

DC voltage exists in the central conductor of the antenna cable. Be sure that the cable connector is installed inside the vehicle.

Globalstar Installation Kit optional accessories



USB
Cable

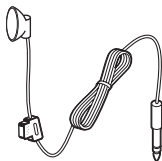

Privacy
Headset

Optional accessories

GHS-1700 Privacy Headset

GDC-1700 USB Data Cable

Optional accessories (not included in kit)

Privacy headset

The privacy headset (GHS-1700) offers more privacy during a call and is connected directly to the phone.

Data cable

A USB data cable (GDC-1700) can connect a computer or other device to the GIK, allowing the phone to send and receive data.

Components



Using the phone in a vehicle

Attaching the phone to the Globalstar Installation Kit

1. Remove GIK connector cover label from back of phone.

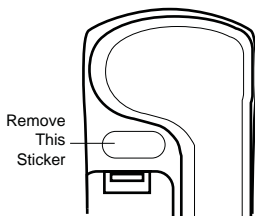

2. Remove rubber plug from connector at bottom of phone. Rotate rubber plug toward antenna.
3. Insert the connector on the bottom of the GIK into the connector on the phone.
4. Push the phone down and back until it locks into place. You should hear a click.
5. To remove the phone, press the release button at the top of the GIK, and gently remove the phone.
6. Replace the rubber plug in the connector.

Operation

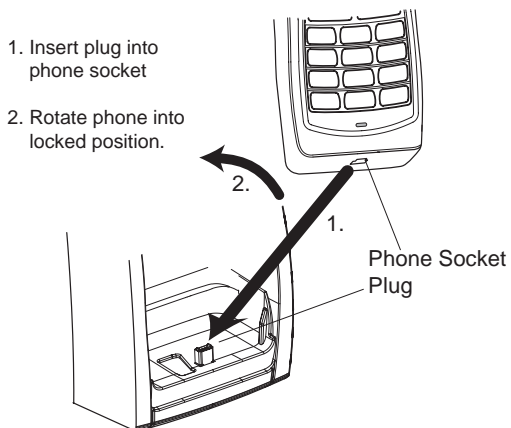

Caution

Do not pull the phone out of the GIK without first pressing the release button. If you do so, you could damage the phone and the GIK.

Turning on the phone and GIK

When you turn on the vehicle's ignition, the phone and the GIK are turned on. The phone is ready to make or receive a call.



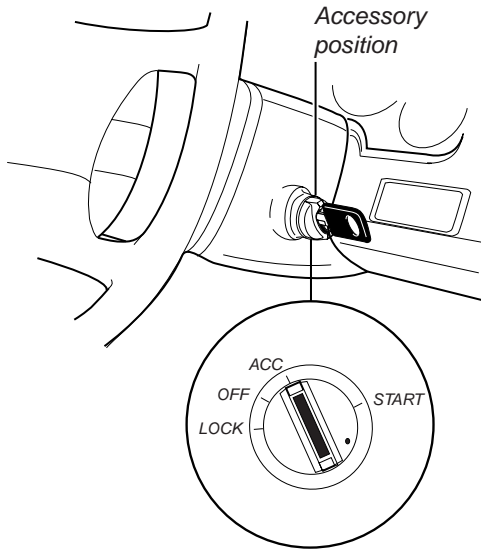

358AB_1999Q



Note

If you turn off the vehicle's ignition during a call, the GIK remains on so you can continue talking. (The GIK will remain on until the phone battery is fully charged. See Charging the phone battery, page 19.)

Charging the phone battery

When a powered on phone is placed in the GIK, whether the ignition is on or off, the GIK powers up and charges the phone's battery. When the charge is complete, the GIK will power down.

Operation

If both the phone and the GIK are powered down and the phone is placed in the GIK, the phone will charge as long as:

- the GIK is wired to the vehicle battery, OR
- the car power adapter cable has power (the light on the cable is lit).

The phone will charge to full and then both the phone and the GIK will power down.

Car stereo mute



Note

This feature requires a car stereo that supports it.

The GIK has the ability to mute the car stereo system automatically when you make or receive a call if the car stereo has an audio mute line (STEREO MUTE).

Hands-free mode

The GIK allows you to use your phone more efficiently and safely while driving in your vehicle. When the phone is properly attached to the GIK and the vehicle's ignition is on, you can speak into the microphone and listen to the other party through the speaker while keeping both hands on the steering wheel.



Caution

You should stop the vehicle in a safe place before attempting to dial a number. If you must talk while the

vehicle is moving, use the Hands-Free microphone so that you can always concentrate on traffic conditions.

If you turn off the vehicle's ignition during a call, the call will not be interrupted. After you terminate the call, the phone will power off in 30 seconds. No subsequent calls can be made unless the ignition is turned on. The GIK will continue to charge until the phone is fully charged.

When you use hands-free mode

- It is recommended that you use one-touch dialing or speed dialing to simplify key operations. See the *QUALCOMM Globalstar GSP-1700 Phone User Guide*.
- Exercise extreme caution with traffic conditions.

Adjusting speaker volume

You can use the volume keys on the side of the phone to adjust the speaker volume. You can:

- Adjust the phone speaker volume while on a call.
- Adjust the ringer volume when the phone is not on a call.



Note

You can also use menus to adjust the volume. Refer to the phone user guide.

Connecting to a personal computer

Connecting a USB data cable (GDC-1700) from your computer or other device to the data port of the GIK allows the phone to send and receive data. See Component parts, page 11.



Note

You cannot use the phone to talk while sending and receiving data.

Privacy Headset

Privacy headset operation

Setting up the headset

Before starting to drive:

1. Remove rubber plug from the headset jack on the left side of the phone. Rotate rubber plug toward the antenna.
2. Plug the privacy headset into the headset jack on the phone.
3. Place the headset over your ear.
4. Speak in the direction of the headset microphone instead of the Hands-Free microphone. You will hear the other party through the earplug.
5. Use the volume keys or Preferences menu on your phone to adjust the volume of the earplug when you are on a call. See the phone user guide.

Using the headset

To make a call with the headset:

1. Dial the desired number on the keypad of your phone.
2. Press  .

When you use the headset, the speaker and microphone are muted, and you can speak in privacy.

To receive a call with the headset:

- When the phone rings, press any key except  . See the phone user guide for information on the AnyKeyAnswer option.

To end a call with the headset:

- Press  .

To switch from the headset to hands-free mode:

- Unplug the headset from the headset jack when you are not driving.

Operation



Troubleshooting

If you have problems using the kit, look at these possible solutions before calling your service provider.

Table 1. Error messages

Message	Recommendation
Antenna not found	Re-check phone connection to the GIK. Re-check cable connections between the GIK, antenna cable, and antenna.
MCU/Communication Error	Re-check phone connection to the GIK.
Kit connected	No troubleshooting necessary.
No message when phone is placed in GIK	Re-check phone connection to GIK. Verify power is supplied to GIK, either via the power-interface cable or the car power adapter.

Table 2. Other problems

Problem	Recommendation
Speaker not working	Verify speaker connection to GIK. Verify volume setting on phone is loud enough to hear speaker.
Microphone is not working	Verify microphone connection to GIK. Verify handset is not set to “mute” during a call.
After charging/ jumping vehicle battery, phone no longer works	Replace GIK fuse on the red wire. Refer to the installation sheet for replacement instructions.



Index

A

- adjusting headset earplug volume 22
- adjusting ringer volume 21
- adjusting speaker volume 21
- air bag safety 7
- antenna cables
 - DC voltage 14

antenna

- cable 9
- exterior 13
- patch 9
- Quadri-filar helix 9
- safety 3

antenna cables

- DC voltage 2

B

battery

- charging 19

C

cables

- antenna 13
 - power interface cable 11
- ## car interface cable
- battery connection 12
 - ground 12
 - ignition sense 12

ignition sense feature 12

stereo mute 12

Car Power Adapter 9

car stereo mute 12, 20

components 11

D

data cable 15

dialing

one touch 21

speed 21

driving safety 4

E

electronic devices 4

exterior antenna 13

F

fuse 2, 26

G

Globalstar Installation Kit 11

attaching the phone 17

components 9

features 1

optional accessories 14

release button 17

standard components 10

turning off 19

turning on 18

H

hands-free mode 20
Hardware Kit 9
hearing aids 5

I

ignition sense
 auto power off 12

J

jump starting your vehicle
 safety precautions 2

L

Literature Kit 9

M

medical devices 5
microphone 9, 11, 20
 connecting 11
 installation 11

O

operation 17
optional accessories 15

P

pacemakers 5
patch antenna 9
power interface cable 11
Power-Interface Cable 9
privacy handset 15
 operation 23
privacy headset 22
 adjusting earplug volume 22

Q

Quadri-filar helix antenna 9

R

radio frequency 2
recharging vehicle battery
 safety precautions 2

S

safety
 air bags 7
 aircraft 6
 antenna 3
 blasting areas 6
 driving 4
 electronic devices 4
 explosive atmospheres 7
 hearing aids 5
 hospitals 6
 medical devices 5
 pacemakers 5
 precautions 1
 radio frequency 2
speaker 9, 11, 20
 connecting 11
 extension cable 9
 mounting bracket 9

T

Troubleshooting
 Error messages 25
 Other problems 26

U

USB data cable 22

Free Manuals Download Website

<http://myh66.com>

<http://usermanuals.us>

<http://www.somanuals.com>

<http://www.4manuals.cc>

<http://www.manual-lib.com>

<http://www.404manual.com>

<http://www.luxmanual.com>

<http://aubethermostatmanual.com>

Golf course search by state

<http://golfingnear.com>

Email search by domain

<http://emailbydomain.com>

Auto manuals search

<http://auto.somanuals.com>

TV manuals search

<http://tv.somanuals.com>