



QUALCOMM Globalstar GSP-1600 Tri-Mode Phone User Guide



This guide is based on the production version of the QUALCOMM Globalstar GSP-1600 Tri-Mode. Software changes may have occurred after this printing.

QUALCOMM reserves the right to make changes in technical and product specifications without prior notice.

QUALCOMM Incorporated
5775 Morehouse Drive, San Diego, CA 92121-1714
Document Number 80-98153-2EN Rev-

Copyright© 1999-2000 QUALCOMM® Incorporated
All rights reserved

This technology was exported from the United States Government. Diversion contrary to U.S. law prohibited.

QUALCOMM® is a registered trademark of QUALCOMM Incorporated.
Digital by QUALCOMM® is a registered trademark of QUALCOMM Incorporated.

SMART KEY™ is a trademark of QUALCOMM Incorporated.

Globalstar™ is a trademark of Loral Qualcomm Satellite Services, Inc.

All other trademarks and registered trademarks are the property of their respective owners.

Printed in the United States of America

Cautions and Warnings	vii
Getting Started	1
Understanding your phone	1
Contacting customer service	1
Solving problems	1
Understanding this guide	1
Manually selecting call mode	2
Preparing for satellite calls	2
Making satellite calls	4
Making cellular calls	4
Making data calls	5
Receiving satellite or cellular calls	5
Ending calls	6
Displaying your phone number	6
Phone Basics	7
Phone features and keypad	7
Display indicators	9
Security module	10
Antenna basics	10
Information key	10
Calling Basics	11
Turning the phone on	11
Turning the phone off	11
Standby mode	11
Power save mode	12
Entering numbers	12
Making emergency calls	13
Redialing a call	13
Muting a call	13
Possible service provider services	13
Menu Basics	15
Accessing main menu	16
Navigating and using menus	16
Phone Book Menu	17
Entering letters and other characters	17
Entering pauses	18
Saving entries	18
Finding entries	19
Editing entries	20
Erasing entries	20
Making entries secret	20
Viewing numbers	21
Prepending numbers	21
Sending tones	21
Speed dialing	22
One-touch dialing	22

Call History Menu	23
Accessing call history list	23
Viewing call history details	24
Messages Menu	25
Voice messages	25
Text messages	26
Features Menu	29
Key Guard	29
Scratchpad	29
Data	30
Call Information Menu	31
Last Call	31
Home Calls	31
Roam Calls	31
Recent Calls	32
Data Calls	32
All Calls	32
Resetting call counters	33
Security Menu	35
Lock code	35
Locking the phone	35
Restricting the phone	36
Entering a new lock code	36
Entering priority numbers	36
Erasing call history list	37
Erasing phone book entries	37
Erasing SMS messages	37
Resetting preferences	38
Entering PIN	38
Preferences Menu	39
Sounds	39
Display	42
SMS Time	45
Language	46
Alerts	46
Calling	47
System Menu	51
Status	51
Find Home	52
Version	52
Service Provider Select	52
Service Provider	55
Territory	55
Manual Mode	56
Auto Mode	56
NAM Select	57
My Numbers	58

Battery Care and Maintenance	59
Battery	59
Battery care and charging	59
Battery chargers	60
Low battery	60
Battery removal	61
Battery replacement	61
Safety Information	63
Exposure to radio frequency signals	63
Antenna care	63
Phone operation	63
Driving	64
Electronic devices	64
Aircraft	65
Blasting areas	65
Potentially explosive atmospheres	65
For vehicles equipped with an air bag	65
Battery care	65
Other safety issues	66
Accessories	67
Battery	67
Leather case	67
AC wall charger	67
Universal travel charger	67
Cigarette lighter adapter	67
Data cables	67
Hands-free car kit	68
Troubleshooting	69

Cautions and Warnings



Warning

Only use the batteries, antennas, and chargers provided by QUALCOMM. The use of any other type may be dangerous.



Warning

Allow only authorized personnel to service the phone and its accessories. Unauthorized service can invalidate the warranty.



Caution

Any changes or modifications to this equipment not expressly approved in this document could void your warranty and your authority to operate this equipment.



Caution

Avoid exposing the phone and accessories to rain or other liquids. If the phone gets wet, turn the power off immediately and remove the battery pack. See Battery Care and Maintenance, page 59, for more information.



Note

When using the QUALCOMM Globalstar Tri-Mode Phone near a television or radio, the phone can cause interference. Regulatory agencies in your area, such as the United States Federal Communications Commission (FCC) or Canadian Industry Canada (IC), can require you to stop using the phone if such interference cannot be eliminated. If you need assistance, contact your satellite or cellular service provider.

Cautions and Warnings

It is *very* important that you read this section because your tri-mode phone is unique – it combines satellite technology and cellular technology in one phone. For more detailed information on usage, refer to the other sections in this guide. If you need further assistance, see Solving problems, page 1.

Understanding your phone

Consider your phone as “two phones in one” because it requires operation in two distinct ways to make and receive two different types of calls:

- Satellite calls – Calls made via satellite. This is known as Globalstar satellite mode.
- Cellular calls – Calls made by cellular phone technology. There are two cellular modes: digital mode and analog mode.



Tip

The calling mode has probably been preset on your phone. To view or change the current setting, set your mode preference (see Auto Mode, page 56) so the mode is automatically selected when you turn your phone on (see Manual Mode, page 56).

Contacting customer service









You may have different service providers for Globalstar satellite service and cellular service. Contact the appropriate service provider for customer service.

Solving problems

If you have problems using your phone, see Troubleshooting, page 69. If you still have trouble, contact your satellite or cellular service provider.

Understanding this guide

These conventions or representations are used in this guide:

Type of Action	Example	Action
Key Presses	Press  .	Press key briefly.
	Press and hold  .	Press key for more than one second.
Using SMART KEY™ options	Press  book .	Press the SMART KEY button  under the appropriate option on the screen.
Scrolling	Scroll to select “yes” or “no.”	Press either the volume buttons on the side of the phone or   and   .

Manually selecting call mode

When you are ready to make a call, you can quickly select the call mode you prefer. You can select Globalstar, cellular (digital or analog), or Auto Mode. If you select Auto Mode, the phone looks for service as specified by the Auto Mode setting (see Auto Mode, page 56).

To manually select a call mode:

- Press and hold *** ↑** to display the mode menu, and press the menu number of the appropriate call mode.

Preparing for satellite calls

- If the security module is not properly installed, you can only make calls to emergency numbers and you cannot receive calls. Your satellite service provider installs and maintains the security module (see Security module, page 10, for more information).
- Charge and properly install the battery. See Battery Care and Maintenance, page 59.
- Rotate the Globalstar satellite antenna located on the back of the phone (see Phone features and keypad, page 7). The antenna will automatically extend as you rotate it and automatically retract when stored.

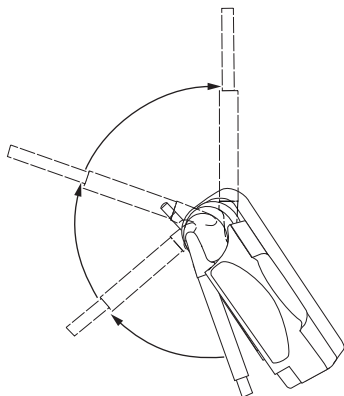

- Move the antenna to its optimal position (pointing straight up to the sky) until it sets into one of three positions. You cannot make or receive a satellite call with the Globalstar satellite antenna stored. The following shows right and wrong antenna positions when making satellite calls:



- Position yourself outdoors so that you can see the whole sky to prevent dropped calls. If a call is dropped, a fade alert sounds if that feature is turned on (see Fade, page 46). For best performance, move away from tall obstacles such as buildings or trees. If you can see the whole sky, the satellites will have a clear view of you and the phone. The phone will *not* operate inside a building or a vehicle unless you are using the car kit.



Note

You can make cellular calls in all of the following locations.

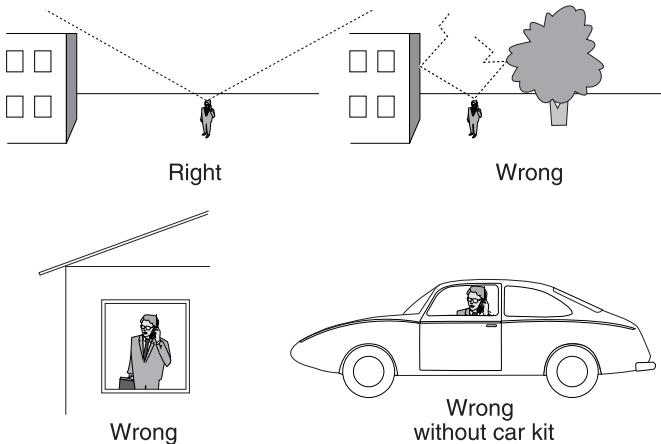

Making satellite calls

1. Rotate the satellite antenna (see Preparing for satellite calls, page 2).
2. Press and hold **(Pwr)** to turn your phone on.
3. Select call mode, if necessary (see Manually selecting call mode, page 2).



Note

The roaming indicator () usually displays immediately if the network roams to find a satellite service provider. Occasionally, the roaming indicator displays after you press **(SEND)**, and you may not see the indicator.

4. Enter the phone number that you want to call (see Entering numbers, page 12). To make international calls, see International dialing, page 13.



Note

When using the keypad or viewing the screen in Globalstar satellite mode, keep the antenna pointing up to maintain service.

5. Press **(SEND)**. A message displays if the phone is locked, if the phone number is restricted, or if there is another problem.

Making cellular calls

1. Press and hold **(Pwr)** to turn your phone on.
2. Select call mode, if necessary (see Manually selecting call mode, page 2).
3. Fully extend the cellular antenna.

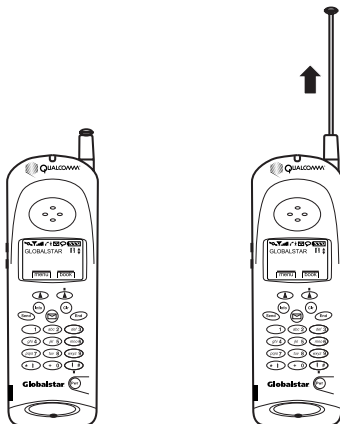

4. Enter the phone number that you want to call (see Entering numbers, page 12).
5. Press **SEND**. A message displays if the phone is locked, if the phone number is restricted, or if there is another problem.

Making data calls

If your satellite service provider offers Globalstar packet data service, you can make data calls in Globalstar mode. The QUALCOMM Globalstar packet data kit allows you to access the Internet or other networks with packet data service.

You need the data cable that connects your computer or Palm™ handheld to your tri-mode phone, and you need to set up your computer or Palm handheld. See the QUALCOMM Globalstar packet data kit user documentation that comes with your data cable for more information on connecting and setting up your computer to your tri-mode phone.

You can then use your computer to send and receive email, use TelNet or FTP, or browse the Internet. See your satellite service provider for more information.

Receiving satellite or cellular calls

To receive a satellite or cellular call

1. Turn your phone on.
2. Rotate the Globalstar antenna or extend the cellular antenna to find service.

When you receive a call, the phone rings, the indicator light flashes, and "Incoming Call" flashes on the screen until you answer the call.



Note

To receive satellite calls, the satellite antenna *must* also be rotated with a view of the whole sky. You can position the phone on its side for better stability:





Note

If you miss a call, you can press either **▲** **ok** to return to standby mode or **▲** **view** to display the call history list for details about the missed call.

3. To answer a call, do one of the following:
- Press **SEND**.
 - From standby mode, press any key except **(Pwr)** or **END** if Any-Key Answer is set to “on” (see Any-Key Answer, page 45).

Ending calls

- Press **END**. The total time of the call briefly displays. You can also obtain the total time of each call in the call history list.

Displaying your phone number

- The currently registered phone number briefly displays when you turn your phone on or press **(Info)** from standby mode.
- To display all three phone numbers (NAMs), press **▲ menu** and then press **(wxyz 9)** for My Numbers. (See My Numbers, page 58.)



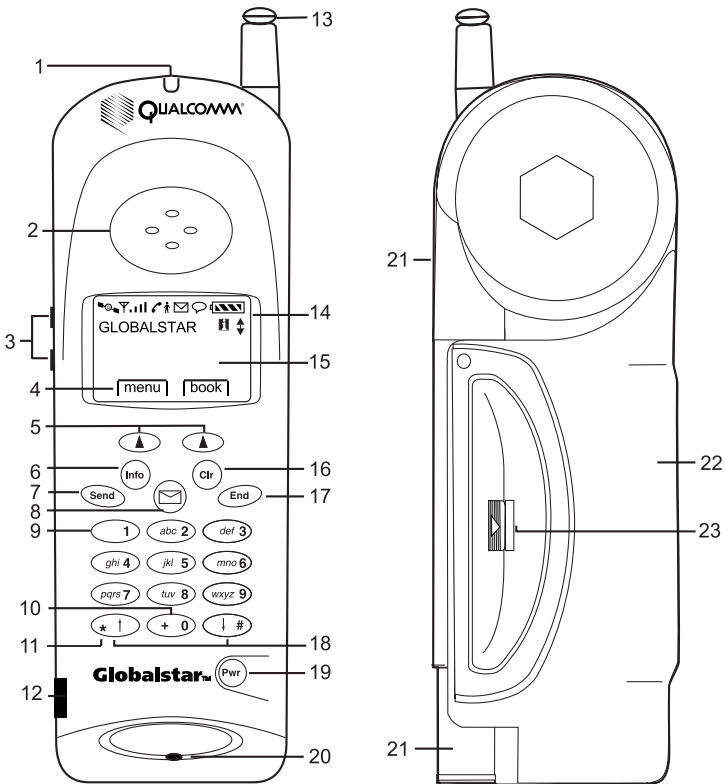

Learn about these topics in this section:

- Phone features and keypad
- Display indicators
- Security module
- Antenna basics
- Information key

Phone features and keypad























1. Light indicator – Flashes when turning phone on, when receiving incoming calls, or when receiving text or voice mail messages.
2. Earpiece

3. Volume buttons – Adjust ringer volume when not on a call. Scroll through the menu items if a scroll arrow displays. Scroll through call history and phone book. Move the cursor when editing alphabetic characters or digits.
4. SMART KEY options – Select the option on the screen by pressing the SMART KEY  below it.
5. SMART KEY buttons – Press the SMART KEY  to select the appropriate option on the screen.
6. Information key – Insert pauses and hyphens. Additional help is available if  displays on the screen (for example, when the phone registers and  displays, press  for service provider information and the current phone number).
7. Send key – Originate or answer a call. Also used for features such as call waiting.
8. Message key – Access text messages and voice mail notifications. See Messages Menu, page 25.
9. Punctuation key – Add punctuation or spaces when entering letters.
10. International dialing or plus (+) key – Make international calls (see International dialing, page 13).
11. Mode select – Press and hold to manually select Globalstar satellite, digital, analog, or auto mode (see Manual Mode, page 56).
12. Security module – Required to activate phone for Globalstar satellite service (see Security module, page 10).
13. Cellular antenna
14. Display indicators – Show phone and battery status (see Display indicators, page 9).
15. Screen
16. Clear key – Delete characters (see Entering numbers, page 12, and Entering letters and other characters, page 17). Return to previous screen.
17. End key – End a call. If not on a call, return to standby mode.
18. Scroll keys – Scroll through menu items if a scroll arrow displays on the screen. Move cursor.
19. Power key – Turn the phone on or off.
20. Microphone
21. Globalstar satellite antenna (see Preparing for satellite calls, page 2).
22. Battery
23. Battery release latch

Display indicators

The indicators on the screen show the status of the phone and the battery charge level at a quick glance.



	Phone operating in Globalstar satellite mode
	Phone operating in digital mode
	Phone operating in analog mode if neither  nor  display
	Signal strength ranging from a strong signal (four lines) to an extremely weak signal (one line)
	Call in progress
	No service available. If service is unavailable, the phone sounds a beep when you try to make a call.
	Roaming – found service outside home area
	Text message received
	Voice mail notification received
	Battery charge. Ranges between four diagonal bars (full charge) to one bar (minimal charge) to no bars and blinking (no charge).
	Help available; press  . For example, displays when the phone is registered and service provider information and the current phone number.
 	Designates additional level of call privacy (digital) or encryption (Globalstar)
	Designates the menu option currently selected
	Indicates that you can scroll between screens using the volume buttons or  and 
	Indicates that either the selected text message is locked or the keypad is locked
	Indicates that the text message is unlocked

Security module

The security module activates your phone when in Globalstar satellite mode. It is located on the lower left side of the front of the phone. The security module that comes with your phone works only with that phone and is not interchangeable.



Caution

Do not remove the security module.

When in Globalstar satellite mode, the security module must be properly installed to make or receive calls. If it is not properly installed, you can only make calls to emergency numbers.



Note

If you use the same phone number (or NAM) for both Globalstar satellite and cellular calls, the security module may also have to be installed for non-emergency cellular calls.

For more information, contact your satellite service provider, who installs and maintains the security module.

Antenna basics

Phone performance depends on the strength of the signal it receives. As you fully extend the cellular antenna or rotate the Globalstar satellite antenna, the signal strength indicator shows the strength of the signal received in that particular antenna position. You cannot make or receive a satellite call with the Globalstar satellite antenna stored.



It is important to use the antennas properly for the best performance. Follow these guidelines for the Globalstar satellite and cellular antennas:

- Never hold the phone by the antenna.
- Do not use the phone if either antenna is damaged, unless you are using the phone with the car kit's antenna.

For more information on how to use the antennas, see Preparing for satellite calls, page 2, and Making cellular calls, page 4.

Information key

The Info (Information) key  has several different functions:

- Provides help if  displays on the screen.
- When the phone registers and  displays on the screen, press  for service provider information and the current phone number.
- Displays your current phone number while on a call.
- Insert pauses and hyphens when entering a phone number.



Learn about these topics in this section:

- Turning the phone on and off
- Standby and power save modes
- Entering numbers
- Making emergency calls, redialing, and muting
- Possible service provider services (international dialing, call waiting, three-way calling, and caller ID)

Turning the phone on

1. Make sure that the battery is charged and properly installed (see Battery chargers, page 60, and Battery replacement, page 61).
2. Press and hold  until the indicator light illuminates (about one second). The phone is now in standby mode (see Standby mode, page 11) and starts looking for service. The message that displays on the screen depends on the service mode selected (see Manual Mode, page 56 or Auto Mode, page 56).
3. Press any key to stop animation, if desired.

Turning the phone off

1. Press and hold  until "Powering Off" displays.
2. Release .



Note

If you press  for less than one second, the phone does not turn off.

Standby mode

After you turn the phone on, it is in standby mode while it looks for service. The following screens show the message that displays when looking for service depending on the service mode selected (see Manual Mode, page 56):

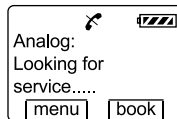
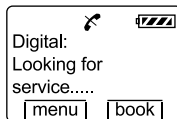
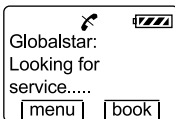

After your phone finds service, your banner, the date and time, and the appropriate icons display.



Note

The date and time may not be available in all modes of service.

Power save mode

If your phone does not find service while in standby mode, it switches to power save mode. Power save mode maximizes battery life by periodically looking for service. The following message displays when your phone is in power save mode:

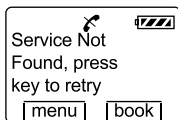

To return to standby mode, press any key.

Entering numbers

You can enter up to 32 numbers and other characters (hyphens and pauses).



Note

All 32 characters do not always display on certain screens and may be replaced by periods (...). To display the entire number, use the View # option in the Phone Book menu (see Finding entries, page 19) or the Call History menu (see Viewing call history details, page 24).

To enter numbers

1. From standby mode, enter the numbers.
2. Do one of the following:
 - Press **SEND** to place the call.
 - Press **save** to save the number in the phone book.

To edit numbers

- Move the cursor by pressing the volume buttons.



Note

You cannot use *** |** or **| #** to move the cursor when entering or editing numbers because these keys are used to enter # or *.

To delete numbers

- Press **Clr** to delete one previous character at a time.
- Position the cursor over a number (press the volume buttons), and press **Clr** to delete.
- Press and hold **Clr** to delete the entire entry.

Making emergency calls

Locking or restricting the phone does not prevent you from making calls to emergency numbers. Contact your satellite or cellular service provider for emergency numbers.

To make an emergency call

1. Enter the emergency number (for example, 911).
2. Press **SEND**.

Redialing a call

To redial the last outgoing number

- Press **SEND**.

Muting a call

While you are on a call, you can mute the microphone so that the caller cannot hear you.

To turn mute on

- Press **▲ mute**. The word “Mute” replaces the word “Time” on the screen until you end the call or turn mute off.

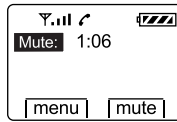

To turn mute off

- Press **▲ mute**. The word “Time” replaces the word “Mute” on the screen.

Possible service provider services

International dialing

To make international calls in Globalstar satellite mode

1. Enter the international access code, the country code, and the phone number.
Shortcut: Press and hold **+ 0** until a plus (+) displays on the screen, and then enter the country code and phone number.
2. Press **SEND**.

If international dialing is supported in your network, contact your satellite service provider for more information.

Call waiting

Call waiting lets you know that you are receiving an incoming call by sounding a beep. For instructions on how to use call waiting, contact your satellite or cellular service provider.

Three-way calling

Three-way calling allows you to talk to two callers at the same time. For instructions on how to use three-way calling, contact your satellite or cellular service provider.

Caller ID

Caller ID displays an incoming call's phone number on the screen, if available. If the phone number of the caller matches one stored in your phone book, the name also displays with the number.

For more information on caller ID, contact your satellite or cellular service provider.



Note

“Flash hook” is sometimes referred to when using call waiting, three-way calling, or caller ID. This means quickly press and release **SEND**.

Learn how to access and navigate through the phone menus in this section.

The phone menus are designed so that you can easily access and navigate through them. The following road map shows the various menus on the main menu, which is accessed by pressing  menu.

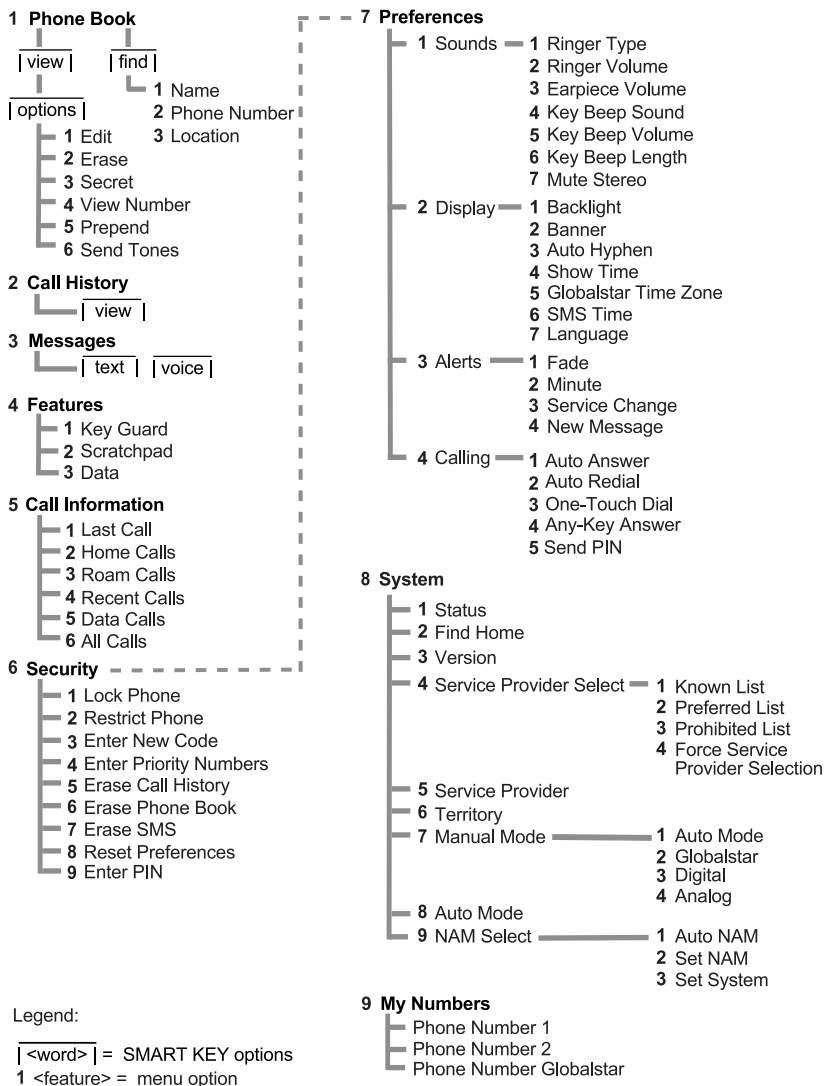



Legend:

| <word> | = SMART KEY options
 1 <feature> = menu option

Accessing main menu

1. Turn the phone on. The phone is now in standby mode (see Standby mode, page 11).
2. Press **▲** **menu** and the first three main menu items display. If scroll arrows display on the screen, you can scroll between screens to access additional menu options.

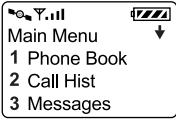
Each main menu item is explained in sequential order in separate sections of this guide.

	page 17 page 23 page 25
	page 29 page 31 page 35
	page 39 page 51 page 58

Navigating and using menus

To navigate the menus

- To access additional menu items when a scroll arrow displays on the screen, press the scroll keys.
- To select a menu item, press the corresponding number.

To save changes or a setting

- Press **▲** **ok**.

To return to previous screen without saving changes

- Press **Ⓞ**.

To return to standby mode without saving changes (if *not* on a call)

- Press **END**.

To return to standby mode without saving changes (if on a call)

- Press **Ⓞ** repeatedly.

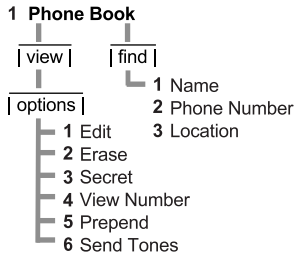

Learn about using the phone book, entering letters and other characters, entering pauses, speed dialing, and one-touch dialing in this section.

Entering letters and other characters

To enter letters and other characters

1. Press a key repeatedly to display the letters in uppercase, then lowercase, and finally the number. For example, if you repeatedly press **(def 3)**, the following characters display:
D E F d e f 3
2. Do one of the following:
 - Enter the next character if it is on a different key.
 - If the next character is on the same key, move the cursor forward by pressing **(↓ #)** or the down volume button.
3. Press **(▲) ok** after you enter the name.

To edit letters and other characters

- Move the cursor by pressing **(* ↓)** or **(↓ #)** or by pressing the volume buttons.

To delete letters and other characters

- Position the cursor over a letter or character, and press **(CtR)** to delete.
- Press **(CtR)** to delete previous letters or characters one at a time.
- Press and hold **(CtR)** to delete the entire entry.

To enter spaces

- Press **(↓ #)** or the down volume button.

To enter punctuation or spaces

- Press **(1)** repeatedly, and the punctuation or space displays in the following order:
– <space> @ & () : . ' # * , 1

Entering pauses

When using automated phone services, such as voice mail or online banking, you can use pauses when entering a series of numbers. You can also enter pauses manually, or you can save pauses in phone book entries. Each pause counts as one character. There are two types of pauses:

- **Hard Pause** – Stops until you press  **resume** to send the rest of the number sequence.
- **Timed Pause** – Stops for two seconds and then resumes automatically.







Note

If Auto Hyphen is set to “on” and you manually enter pauses, Auto Hyphen is temporarily set to “off.” (See Auto Hyphens, page 43 and Manual Hyphens, page 43.)

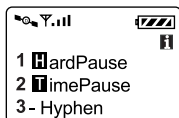
To enter pauses when entering numbers

1. Press  and the following displays on the screen:



2. Press  for Hard Pause or  for Timed Pause.  displays for hard pauses and  displays for timed pauses.
3. Continue entering numbers.

Saving entries



The phone saves up to 99 entries. Each entry contains a name (up to 12 characters) and phone number (up to 32 numbers) stored in location numbers 1 through 99. See Entering numbers, page 12.

You can also save pauses in phone book entries when automated phone services, such as voice mail or online banking, require personal identification or account numbers. See Entering pauses, page 18.

To save entries

1. Do one of the following:
 - Enter a phone number from standby mode and press  **save**.



- Select a number on the call history list, and press  **view**,  **options**, and  **save**.

- Enter a number into the scratchpad, and press **options** and **save** (see Scratchpad, page 29).
 - Select a number on the screen, such as Caller ID, and press **save**.
2. Enter a name and press **ok**.
 3. Do one of the following to select a location number:
 - If the phone book is *not* full, you are asked to accept an empty location. You can either:
 - Press **ok** to accept the empty location.
 - Enter a location number of your choice and press **ok**.
 - Scroll to select an empty location and press **ok**.
 - If the phone book is full, enter a location number that you want to reuse and replace with the new information. You will lose the old information.

Finding entries

You can find entries by name, phone number, or location number. You can also quickly advance to groups of ten entries or scroll through each entry one at a time.

To find an entry

1. From standby mode, press **book**.
2. Do one of the following:
 - Scroll through each entry one at a time.
 - To advance to groups of ten entries, enter 1 through 9. (For example, if you enter 6, location number 60 is selected. If 60 is empty, the previous filled location is selected.)
 - To find specific entries:
 - Press **find**.
 - Press **1** for Name, **abc 2** for Phone #, or **def 3** for Location.
 - Enter one or more characters.



Note

Searches ignore differences between upper- and lowercase letters.

- Press **find** and, if necessary, scroll through the entries.
- Press **view** to see the entry.
- Do one of the following:
 - Press **SEND** to call the number.
 - Press **options** to edit, erase, make secret, view number, prepend (add), or send tones.

Editing entries

1. From standby mode, press **▲** **book**.
2. Find the entry and press **▲** **view**.
3. Press **▲** **options**.
4. Press **1** to Edit.
5. Press **1** to edit Name, **abc 2** to edit Phone #, or **def 3** to edit Location.
6. Edit the name or phone number and press **▲** **ok**, or do one of the following to edit a location number:
 - Press **▲** **ok** to use the same location number.
 - Enter a location number of your choice and press **▲** **ok**.
 - Scroll to select an empty location and press **▲** **ok**.

Erasing entries

1. From standby mode, press **▲** **book**.
2. Find the entry and press **▲** **view**.
3. Press **▲** **options**.
4. Press **abc 2** to Erase.
5. Press **▲** **ok**.

Making entries secret

To prevent a phone number from displaying on the screen, you can make the entry "Secret." To view or change a secret entry, you must use your lock code. (See Lock code, page 35.)



Note

When receiving an incoming call, caller ID prevents the name from displaying if the entry in your phone book is secret.

To make an entry secret or nonsecret

1. From standby mode, press **▲** **book**.
2. Find the entry you want to make secret.
3. Press **▲** **view**.
4. Press **▲** **options**.
5. Press **def 3** and scroll to select:
 - Yes – Makes the entry secret
 - No – Makes the entry nonsecret
6. Press **▲** **ok**.

To view or change a secret entry

1. From standby mode, press **▲** **book**.
2. Find the secret entry and enter your lock code.
3. Press **▲** **ok** to accept any changes you make.

Viewing numbers

You can view an entry's entire phone number. When viewing a number, you can also prepend (add) numbers at the beginning of a phone number and save those changes.

To view numbers

1. From standby mode, press **▲** **book**.
2. Find the entry and press **▲** **view**.
3. Press **▲** **options**.
4. Press **ghi 4** for View #.
5. Do one of the following:
 - Press **▲** **ok** to return to the previous menu.
 - Press **END** to return to standby mode.

Prepending numbers

You can permanently prepend (add) numbers, such as an area code or country code, at the beginning of a phone number in an existing phone book entry.

To prepend (add) numbers

1. From standby mode, press **▲** **book**.
2. Find the entry and press **▲** **view**.
3. Press **▲** **options**.
4. Press **jkl 5** for Prepend. The phone number displays.
5. Enter the numbers.
6. Press **▲** **save**.

Sending tones

You can send DTMF (dual tone multi-frequency) tones over the air when using automated phone services, such as voice mail or online banking. To send tones, you must be on a call. You can send tones by manually entering numbers or sending numbers stored in your phone book. You can also send tones for numbers entered in the scratchpad (see Scratchpad, page 29).



Note

The length of the key beep, the sound you hear when pressing the keys, affects the DTMF tones in analog mode. Check your key beep length before sending tones (see Key Beep Length, page 41).

To send tones manually

- While on a call, enter the appropriate numbers. The tones associated with the numbers are immediately sent over the air.

To send tones saved in your phone book

1. While on a call, press **▲** **book**.
2. Find an entry and press **▲** **view**.
3. Press **▲** **options**.
4. Press **mno 6** for Send Tones. The tones associated with the numbers are immediately sent over the air.

Speed dialing

You can speed dial a phone number if you know the location number of the phone book entry. You can speed dial any of the 99 location numbers unless the phone is restricted (see Restricting the phone, page 36). If you restrict the phone, only the first nine phone book locations are available for speed dial.

To speed dial a phone number

1. Enter the location number.
2. Press **SEND**.

One-touch dialing

If you set one-touch dial to “on,” you can dial any of the 99 location numbers without pressing **SEND**. To set one-touch dial, see One-Touch Dial, page 48.

To one-touch dial a location number

1. Set one-touch dial to “on” (see One-Touch Dial, page 48).
2. Press and hold the location number. For double-digit locations, press and release the first digit, and then press and hold the second digit. For example:
 - Press and hold **def 3** for location number 3.
 - Press **def 3** and then press and hold **abc 2** for location number 32.

Call History Menu

2 Call History (Call Hist)





You can access a call history list of the last ten incoming or outgoing satellite or cellular calls (numbered 0 to 9) and view details about each call type:

- **Called By** Incoming calls, if caller ID is available (see Caller ID, page 14)
- **Call To** Outgoing calls
- **Added** Scratchpad entries (see Scratchpad, page 29)
- **Missed** Unanswered incoming calls, if caller ID is available
- **Caller ID** Caller ID information received
- **Call Waiting** Call-waiting information received during a call





The most recent call is numbered 0 and displays at the top of the list and the oldest call at the bottom (separated by a dashed line). When the list is full, a new call takes the first position in the list and the oldest call is deleted. The list is saved after you turn the phone off.

Names display in the call history list if the caller's phone number is stored in the phone book. If more than one name matches a call back number, the entry with the lowest phone book location number displays.

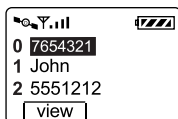
Accessing call history list

1. From standby mode, press  **menu**.
2. Press  for Call History.
3. Press the scroll keys to access the last ten calls. For example:



4. Scroll down to select a call from the most recent to the oldest calls, or scroll up to select a call from the oldest to the most recent.
5. Do one of the following:
 - To call the number, press .
 - To save the number in your phone book, press  **view** and  **save** (see Saving entries, page 18).
 - To exit call history without calling or storing a number, press  or .

Viewing call history details

1. Scroll to select a call on the list.
2. Press  **view**.

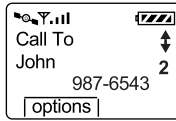

3. Press  **options** and select one of the following:
 - Date/Time – Display the date and time of the call.
 - Duration – Display the duration of the call.
 - Save – Save the number in your phone book.
 - View # – View the entire number.
 - Send – Make a call to the number.
 - Send Tones – Send DTMF tones while on a call. (For more information on DTMF tones, see Sending tones, page 21.)
 - Prepend – Add numbers, such as an area code or country code, at the beginning of the phone number and save it in your phone book.

3 Messages

| text | | voice |

Learn about retrieving SMS (short message service) messages in this section. SMS includes both text and voice mail notification messages. Contact your satellite or cellular service providers for information regarding the availability of text and voice mail notifications.

You can retrieve text messages and voice mail notifications from satellite or cellular service provider voice mail systems. When the phone is turned on and you receive SMS messages, the phone alerts you by flashing the indicator light, sounding a beep, and displaying the text message indicator ☑ or voice mail notification indicator ☎ on the screen. The text message and voice mail notification indicators display until all messages are read.

When you read a message, new messages are accessed before old messages. If the message contains a call back number matching one in your phone book, the corresponding name displays in place of the number. If more than one name matches a call back number, the entry with the lowest phone book location number displays.

Voice messages

If someone leaves you a voice mail message, your phone receives a voice mail notification and alerts you. You can then access the voice mail notification. (Service providers may provide different details about the message.) To hear the voice mail message, call your voice mail system.

If you have one or more voice mail systems, the total number of voice mail messages received by all systems displays on the screen. For example, if you have two voice mail systems and you receive two voice mail messages from one system and two from the other system, the total number of voice mail notifications displays under "Old":

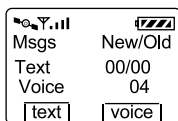



If new voice mail messages are received, the total number of voice mail notifications is updated.







To access voice mail notifications

1. From standby mode, press ☎. The total number of voice mail messages received displays under "Old."
2. Press ▲ **voice**. The voice mail notification displays either a call back number or a name if the call back number matches one in the phone book. If more than one name matches a call back number, the entry with the lowest phone book location number displays.







3. Do one of the following:

- Press  **next** to read the next voice mail notification.
- Press  **view** to display more detail, if available, which automatically scrolls on the screen and pauses so you can read it. Press a scroll key to manually scroll.

To call your voice mail system

1. Press .
2. Press  **voice**.
3. Press  **next** to find the voice mail notification you want.
4. Press  **view**.
5. Press . The phone number for the voice mail system displays, if available. Go to Step 6. If it does not display, the message "No Voice Mail Number received" displays, and you must manually enter the voice mail phone number.
6. If necessary, prepend (add) digits before the voice mail phone number. For example, if you are out of the area of your voice mail phone number, prepend the area code or country code.
7. Press  again.
8. Follow the voice mail system instructions to retrieve your messages.



To erase voice message notifications

1. Press .
2. Press  **voice**.
3. Press  **next** to find the voice mail notification you want.
4. Press  **view**.
5. Press  **erase** to erase the message.
6. Press  **ok**.



Text messages

Text messages can include call back numbers, messages, urgency stamps, time and date stamps, and possibly names if the call back number matches one in the phone book. The phone stores as many text messages as available memory allows. For more information on managing phone memory, see Storing text messages, page 27.







To access text messages

1. Press . The number of new and old text messages displays.
2. Press  **text**. The newest unread messages display first followed by the newest read messages, if any. The number of messages under "Old" is the number of messages you accessed.





3. Do one of the following:

- Press  **next** to read the next message.
- Press  **view** to display more detail, if available, which automatically scrolls on the screen and pauses so you can read it. Press a scroll key to manually scroll.

To call back numbers in text messages

1. Press .
2. Press  **text**.
3. Press  **next** to find the message you want.
4. Press  **view**.
5. Press . The call back number displays, if available.
6. If necessary, prepend (add) digits before the call back number. For example, if you are out of the area of the phone number, prepend the area code or country code.
7. Press  again.

To erase text messages

1. Press .
2. Press  **text**. A text message displays.
3. Press  **view** to display more detail, if available, which automatically scrolls on the screen and pauses so that you can read it. Press a scroll key to manually scroll.
4. Scroll to the bottom of the message and press  **options**.
5. Press  for Erase.



Note

You can erase a text message even if it is locked.

6. Press  **ok** to erase the message.

Storing text messages

Text messages are saved until you erase them or until the phone memory is full. If more than 75% of the phone's memory is full, a message displays the amount of memory used:

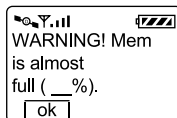

When the phone is out of memory, the oldest unlocked messages are automatically deleted as necessary to receive new messages.

To prevent messages from being deleted, you can lock them. However, if all messages are locked when a new message is received and the phone is out of memory, the new message is lost. The network may try to deliver it later.

To avoid running out of memory

- Erase locked or unlocked messages that you no longer need. When the phone is out of memory and all text messages are locked, it no longer accepts new messages and this message displays:

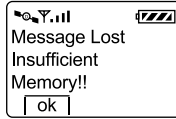









The network may try to deliver lost messages later.

Locking and unlocking text messages

To prevent messages from being automatically deleted if the phone is out of memory, you can lock them. You can manually erase a text message even if it is locked.

To lock or unlock text messages

1. Press .
2. Press  **text**. The newest text message displays.
3. Press  **view** to display more detail, if available, which automatically scrolls on the screen and pauses so that you can read it. Press a scroll key to manually scroll.
4. Scroll to the bottom of the message and press  **options**.
5. Press  for Lock or  for Unlock.

The lock indicator  or the unlock indicator  displays to the left of the SMART KEY options.

4 Features

- 1 Key Guard
- 2 Scratchpad
- 3 Data

Key Guard

The key guard locks the phone keys to prevent accidental use. If you receive an incoming call when the key guard is on, you can answer the call by pressing **SEND**. The key beeps are silenced when the keyguard is set to “on.”

To turn the key guard on

- *Shortcut:* From standby mode, press and hold **END**. The lock indicator  and “KeyGuard On” displays.

To turn the key guard off

- Press **1** **abc 2** **def 3**.



Note

You can also lock your phone to prevent unauthorized use. See Locking the phone, page 35.

Scratchpad

You can enter numbers on the scratchpad to add to call history, save to your phone book, or send tones over the air for automated phone services, such as voice mail or banking online. To add to call history or save to your phone book, you can be on a call or in standby mode. To send tones, you must be on a call.





To access the scratchpad

1. From standby mode, press **▲** **menu**.
2. Press **ghi 4** for Features.
3. Press **abc 2** for Scratchpad.
4. Enter numbers.
5. Press **▲** **options**.
6. Press:
 - **1** to AddToHist; the number is added to call history.
 - **abc 2** to Save to your phone book (see Saving entries, page 18).
 - **def 3** to Send Tones; the tones are immediately sent over the air.

Data

With this feature, you can set the baud rate when making data calls. The baud rate is the speed at which the phone communicates the data to or from the attached terminal equipment (for example, your computer or Palm™ handheld).

To set the baud rate:

1. From standby mode, press  menu.
2. Press  for Features
3. Press  for Data.
4. Scroll to select baud rate 9600, 19200, 38400, 57600, and 115200.
5. Press  ok.

See the QUALCOMM Globalstar packet data kit user documentation that comes with your data cable for more information on making data calls.

Call Information Menu

5 Call Information (Call Info)

- 1 Last Call
- 2 Home Calls
- 3 Roam Calls
- 4 Recent Calls
- 5 Data Calls
- 6 All Calls

The Call Information menu contains counters that allow you to track the number of calls and airtime for billing purposes.

Last Call

Last Call displays the duration of the last call in minutes and seconds. If Call History is empty, "None" displays on the screen.

To display last call information

1. From standby mode, press **▲** **menu**.
2. Press **(jkl 5)** for Call Information.
3. Press **(1)** for Last Call.
4. Press **▲** **ok**.

Home Calls

Home Calls displays the number and duration of all incoming and outgoing calls made in your home service area. You can reset this counter to zero (see Resetting call counters, page 33).

To display home calls information

1. From standby mode, press **▲** **menu**.
2. Press **(jkl 5)** for Call Information.
3. Press **(abc 2)** for Home Calls.
4. Press **▲** **ok**.

Roam Calls

Roam Calls displays the number and duration of roam calls. Roaming occurs when you move out of your home service area. You can reset this counter to zero (see Resetting call counters, page 33).

To display roam calls information

1. From standby mode, press **▲** **menu**.
2. Press **(jkl 5)** for Call Information.
3. Press **(def 3)** for Roam Calls.
4. Press **▲** **ok**.

Recent Calls

Recent Calls displays the number and duration of calls made or received since resetting the counter. You can reset this counter to zero (see Resetting call counters, page 33).

To display recent calls information

1. From standby mode, press **▲** **menu**.
2. Press **jkl 5** for Call Information.
3. Press **ghi 4** for RecentCall.
4. Press **▲** **ok**.

Data Calls

Data Calls displays the number of bytes received or transmitted and the duration of data calls made since resetting the counter.

To display data calls information

1. From standby mode, press **▲** **menu**.
2. Press **jkl 5** for Call Information.
3. Press **jkl 5** for Data Calls.
4. Scroll to view the number of bytes received or transmitted and the duration of the calls.
5. Press **▲** **ok**.

See the QUALCOMM Globalstar packet data kit user documentation that comes with your data cable for more information on making data calls.

All Calls

All Calls displays the number and duration of all calls (both voice and data) for the lifetime of your phone. You cannot reset this counter.

To display all calls information

1. From standby mode, press **▲** **menu**.
2. Press **jkl 5** for Call Information.
3. Press **mno 6** for All Calls.
4. Press **▲** **ok**.

Resetting call counters

You can only reset the Home Calls, Roam Calls, Recent Calls, and Data Calls counters to zero. You can also undo the counter reset, but you must do it before you press  **ok**, which confirms resetting the counter.

To reset the counter to zero

1. Press  **zero**.



Note

After you press  **ok**, you cannot undo the counter reset.

2. Press  **ok**.

To undo the counter reset

- Press  **undo**.

6 Security

- 1 Lock Phone
- 2 Restrict Phone
- 3 Enter New Code
- 4 Enter Priority Numbers
- 5 Erase Call History
- 6 Erase Phone Book
- 7 Erase SMS
- 8 Reset Preferences
- 9 Enter PIN



Lock code

When you access the Security menu for the first time, enter the lock code supplied by your satellite or cellular service provider. If you forget your lock code, contact your satellite or cellular service provider.

Locking the phone

You can lock the phone so that you can only make calls to priority numbers and emergency numbers and receive calls. There are no shortcuts for dialing emergency numbers or priority numbers when your phone is locked. All other functions are locked. To unlock the phone, use the lock code, the same one that you use to access the Security menu.

To lock the phone

1. From standby mode, press  **menu**.
2. Press  for Security and enter your lock code.
3. Press  for Lock Phone.
4. Scroll to select one of these options:
 - Never – The phone cannot be locked.
 - Now – Immediately locks the phone for one time only.
 - On Power Up – Locks the phone every time you turn the phone on.



To unlock the phone

1. Press  **unlock**.
2. Enter your lock code to return to the main menu. (Use the same lock code used to access the Security menu.)

Restricting the phone

When you restrict your phone, you can only make calls to emergency numbers, priority numbers, and phone book locations 1 to 9. You cannot make changes to the phone book when you restrict your phone.

To restrict the phone

1. From standby mode, press  **menu**.
2. Press  for Security and enter your lock code.
3. Press  for Restricted.
4. Scroll to select one of these options:
 - Yes – Make calls to emergency numbers, priority numbers, and phone book locations 1 to 9 only. There are no shortcuts for dialing emergency numbers or priority numbers unless you add them to your phone book.
 - No – Make calls to any number.





Entering a new lock code

The lock code is used to access the Security menu and unlock your phone. Contact your satellite or cellular service provider for information about entering a new lock code.

Entering priority numbers

You can call priority numbers when the phone is locked or restricted. You can store up to three priority numbers (up to 32 digits each).

To enter a priority number

1. From standby mode, press  **menu**.
2. Press  for Security and enter your lock code.
3. Press  for Priority #.
4. Scroll to Priority#1, Priority#2, or Priority#3.
5. Press  **edit**.
6. Enter the phone number.
7. Press  **ok**.

Erasing call history list

To erase the entire call history list

1. From standby mode, press **▲** **menu**.
2. Press **mno 6** for Security and enter your lock code.
3. Press **jkl 5** for Erase Call.
4. Press **▲** **ok**.
5. Press **▲** **ok** to erase the entire call history list, or press **END** if you do not want to erase it.

Erasing phone book entries

To erase all entries in the phone book

1. From standby mode, press **▲** **menu**.
2. Press **mno 6** for Security and enter your lock code.
3. Press **mno 6** for Erase Book.
4. Press **▲** **ok**.
5. Press **▲** **ok** to erase all entries in the phone book, or press **END** if you do not want to erase them.

Erasing SMS messages

You can erase all SMS (short message service) messages, which include all locked or unlocked text messages and all voice mail notification messages.





1. From standby mode, press **▲** **menu**.
2. Press **mno 6** for Security and enter your lock code.
3. Press **pqrs 7** for Erase SMS (short message service).
4. Press **▲** **ok**.
5. Press **▲** **ok** to erase all messages, or press **END** if you do not want to erase them.

Resetting preferences

You can reset all preferences to the original settings (defaults) that were previously set by your satellite or cellular service provider. These preferences include those described in Preferences Menu, page 39, with these exceptions:

- The banner is *not* reset.
- The Service Provider Preferred and Prohibited Lists *are* deleted (see Service Provider Select, page 52).
- The lock code is *not* reset.
- The phone book, call history, or SMS messages are *not* erased.

To reset preferences

1. From standby mode, press  **menu**.
2. Press  for Security and enter your lock code.
3. Press  for Reset Prefs.
4. Press  **ok**.
5. Press  **ok** when prompted to reset all preferences.





Entering PIN

When making analog calls, your cellular service provider may support the use of your own PIN (personal identification number) for verification before connecting your call.

If you want to be prompted for your PIN before making analog calls, set Send PIN accordingly (see Send PIN, page 49). Contact your cellular service provider for more information.

Each PIN is associated with a different phone number, or NAM (number assignment module). When you enter a PIN, it becomes associated with the currently selected phone number, so be sure to select the appropriate phone number before entering your PIN.

To enter your PIN

1. Select the appropriate phone number (NAM) (see NAM Select, page 57).
2. From standby mode, press  **menu**.
3. Press  for Security and enter your lock code.
4. Press  for Enter PIN.
5. Enter the four-digit PIN.
6. Press  **save**.

7 Preferences	
1 Sounds	1 Ringer Type 2 Ringer Volume 3 Earpiece Volume 4 Key Beep Sound 5 Key Beep Volume 6 Key Beep Length 7 Mute Stereo
2 Display	1 Backlight 2 Banner 3 Auto Hyphen 4 Show Time 5 Globalstar Time Zone 6 SMS Time 7 Language
3 Alerts	1 Fade 2 Minute 3 Service Change 4 New Message
4 Calling	1 Auto Answer 2 Auto Redial 3 One-Touch Dial 4 Any-Key Answer 5 Send PIN

Sounds

You can set ringer type, ringer volume, earpiece volume, key beep sound, key beep volume, key beep length, and mute stereo.

Ringer Type

You can change the ringer for incoming calls to one of eight different rings or songs.

To set the ringer type

1. From standby mode, press **▲** menu.
2. Press **(pqrs 7)** for Preferences.
3. Press **(1)** for Sounds.
4. Press **(1)** for Ringer Type.
5. Scroll to select the ringer type or song.
6. Press **▲** ok.

Ringer Volume

Do one of the following from standby mode:

- Press the volume buttons.
- Press **▲** menu.
 - Press **(pqrs 7)** for Preferences.
 - Press **(1)** for Sounds.
 - Press **(abc 2)** for Ringer Vol.

- ❑ Scroll to select the volume level from 1 (lowest) to 9 (highest) or Silent to turn the ringer off. While in standby mode, “-Ringer Off-” alternates on the screen with the time.
- ❑ Press **▲** **ok**.

To silence the ringer when receiving a call

- Press **END**.

Earpiece Volume

You can adjust the earpiece volume to one that is comfortable for you. You can adjust the volume while on a call or from standby mode. If you are using the car kit, this feature adjusts the speaker volume or the privacy handset volume, depending on which one you use.

To adjust the earpiece volume

- While on a call, press the volume buttons.
- From standby mode:
 - a. Press **▲** **menu**.
 - b. Press **pqrs 7** for Preferences.
 - c. Press **1** for Sounds.
 - d. Press **def 3** for EarpiecVol.
 - e. Scroll to select the volume level from 1 (lowest) to 9 (highest).
 - f. Press **▲** **ok**.

Key Beep Sound

You can set the key beep, the sound you hear when pressing the keys, to either a tone or a click.

To adjust the key beep sound

1. From standby mode, press **▲** **menu**.
2. Press **pqrs 7** for Preferences.
3. Press **1** for Sounds.
4. Press **ghi 4** for KeyBeepSound.
5. Scroll to select “tone” or “click.”



Note

If you select “click” and you are on a call, keys pressed for voice mail sound as “tones.” Other keys pressed in menus sound as “clicks.”

6. Press **▲** **ok**.

Key Beep Volume

You can adjust the volume of the key beep, the sound you hear when pressing the keys.

To adjust the key beep volume

1. From standby mode, press **▲** **menu**.
2. Press **pqrs 7** for Preferences.
3. Press **1** for Sounds.
4. Press **jkl 5** for KeyBeepVol.
5. Scroll to select the volume level from 1 (lowest) to 9 (highest) or Silent to turn the key beep off.
6. Press **▲** **ok**.

Key Beep Length

You can set the length of the key beep, the sound you hear when pressing the keys. The standard key beep is short and fixed in length. The custom key beep sounds as long as you press a key.

Using the standard key beep setting is recommended unless a service or device, such as an answering machine, requires a custom key beep.



Note

In analog mode, the key beep length affects the DTMF tones used for sending tones over the network for automated phone services, such as voice mail or online banking. Select the appropriate key beep length before sending tones (see Sending tones, page 21).





To set the key beep length

1. From standby mode, press **▲** **menu**.
2. Press **pqrs 7** for Preferences.
3. Press **1** for Sounds.
4. Press **mno 6** for KeyBeepLen.
5. Scroll to select one of the following:
 - Standard – Key beep is short and fixed in length.
 - Custom – Key beep sounds as long as you press a key.
6. Press **▲** **ok**.

Mute Stereo

To use this feature, the car kit mute line must be connected to the stereo mute line. (Contact your service provider or car kit installer for more information on implementing this in your vehicle.) While using the car kit, you can set this feature to automatically mute the stereo in your vehicle so you cannot hear it. This occurs when you receive incoming calls or press **SEND** when making calls.

To mute the stereo

1. Be sure that the car kit mute line is connected to the stereo mute line.
2. From standby mode, press  **menu**.
3. Press  for Preferences.
4. Press  for Sounds.
5. Press  for Mute Stereo.
6. Scroll to select "yes" or "no."
7. Press  **ok**.





Display

You can set the backlight, edit the banner, display the time, set the auto hyphen feature, and set the Globalstar time zone.

Backlight

You can set the screen and keypad backlighting to maximize battery life.

To set the backlight

1. From standby mode, press  **menu**.
2. Press  for Preferences.
3. Press  for Display.
4. Press  for Backlight.
5. Scroll to select one of the following:
 - Always Off – The backlight is always off, which significantly *increases* battery life.
 - 7 Seconds – Turns the backlight off 7 seconds after the last key press.
 - 15 Seconds – Turns the backlight off 15 seconds after the last key press.
 - 30 Seconds – Turns the backlight off 30 seconds after the last key press.
 - Always On – The backlight is always on, which significantly *decreases* battery life.
6. Press  **ok**.

To turn the backlight on

- Press any key.











Note

If this feature is set to "Always Off," pressing any key does *not* turn the backlight on. You must select a different setting.

Banner

You can enter a banner or personal greeting (up to 12 characters), such as a company name or a personal reminder. The banner displays when you turn the phone on.

To edit the banner

1. From standby mode, press  **menu**.
2. Press  for Preferences.
3. Press  for Display.
4. Press  for Banner.
5. Press  **edit**. See Entering numbers, page 12.
6. Press  **ok** to confirm banner changes.
7. Do one of the following:
 - Press  **ok** to return to standby mode.
 - Press  **edit** to change the banner.





Auto Hyphens

You can use this feature to automatically insert hyphens when you enter phone numbers. As the following example shows, hyphens are inserted automatically when numbers are entered:

- ### - ### -

You can also manually enter hyphens (see Manual Hyphens, page 43).

To set auto hyphen

1. From standby mode, press  **menu**.
2. Press  for Preferences.
3. Press  for Display.
4. Press  for AutoHyphen.
5. Scroll to select “yes” or “no.”
6. Press  **ok**.

Manual Hyphens

You can manually enter hyphens from standby mode or when editing phone numbers in the phone book. You can also set Auto Hyphen to “on” so that hyphens are automatically entered (see Auto Hyphens, page 43). Each hyphen counts as one character.

To manually enter a hyphen

1. Press  and the following displays on the screen:

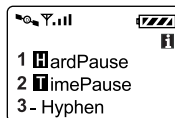





2. Press  to display a hyphen on the screen.

Show Time

You can set the time format using this feature. Initially, while in Globalstar satellite mode, UTC (universal coordinated time) displays. While in digital or analog mode, local time displays where available. To change the time zone that is used to display time while in Globalstar satellite mode, see Globalstar Time Zone, page 44.

To set the time format

1. From standby mode, press  menu.
2. Press  for Preferences.
3. Press  for Display.
4. Press  for Show Time.
5. Scroll to select one of the following:
 - 12 hour – Time displays in 12-hour format
 - 24 hour – Time displays in 24-hour format
 - UTC (universal coordinated time) – 24-hour time scale maintained by the Bureau International de L'Heure
 - Off – Time does not display
6. Press  ok.

Globalstar Time Zone

When in Globalstar satellite mode, this feature allows you to select the display of a different time zone instead of UTC (universal coordinated time) time. The time zone remains selected until you change it and is only valid for Globalstar satellite mode. You can also choose UTC plus or minus any hour if your time zone is unavailable.

The time zones for selection include the following:

European	GMT	Greenwich Mean Time	same as UTC
	BST	British Summer Time	UTC + 1 hour
	IST	Irish Summer Time	UTC + 1 hour
	WET	Western Europe Time	same as UTC
	WEST	Western Europe Summer Time	UTC + 1 hour
	CET	Central Europe Time	UTC + 1 hour
	CEST	Central Europe Summer Time	UTC + 2 hours
	EET	Eastern Europe Time	UTC + 2 hours
	EEST	Eastern Europe Summer Time	UTC + 3 hours
	MSK	Moscow Time	UTC + 3 hours
	MSD	Moscow Summer Time	UTC + 4 hours

U.S. and Canada	AST	Atlantic Standard Time	UTC – 4 hours
	ADT	Atlantic Daylight Saving Time	UTC – 3 hours
	EST	Eastern Standard Time	UTC – 5 hours
	EDT	Eastern Daylight Saving Time	UTC – 4 hours
	CST	Central Standard Time	UTC – 6 hours
	CDT	Central Daylight Saving Time	UTC – 5 hours
	MST	Mountain Standard Time	UTC – 7 hours
	MDT	Mountain Daylight Saving Time	UTC – 6 hours
	PST	Pacific Standard Time	UTC – 8 hours
	PDT	Pacific Daylight Saving Time	UTC – 7 hours
	HST	Hawaiian Standard Time	UTC – 10 hours
	AKST	Alaska Standard Time	UTC – 9 hours
	AKDT	Alaska Daylight Saving Time	UTC – 8 hours

To select a different time zone

1. From standby mode, press **▲** menu.
2. Press **(pqrs)7** for Preferences.
3. Press **(abc)2** for Display.
4. Press **(jkl)5** for G* TimeZone.
5. Scroll to select the appropriate time zone.
6. Press **▲** ok.

SMS Time

With this feature, you can adjust the time stamp displayed for SMS messages (probably UTC, or universal coordinated time) to one you select with the Globalstar Time Zone feature.

To set the SMS time stamp

1. From standby mode, press **▲** menu.
2. Press **(pqrs)7** for Preferences.
3. Press **(abc)2** for Display.
4. Press **(mno)6** for SMS Time.

5. Scroll to select one of the following:
 - As received – Time displays as received, probably in UTC format
 - Adjust – Adjusts one selected under Globalstar Time Zone (see Globalstar Time Zone, page 44)
6. Press **▲** **ok**.

Language

You can select the language displayed on your phone's screen.

To set the language

1. From standby mode, press **▲** **menu**.
2. Press **pqrs 7** for Preferences.
3. Press **abc 2** for Display.
4. Press **pqrs 7** for Language.
5. Scroll to select English, Español, Français, or Português.
6. Press **▲** **ok**.

Alerts

For your convenience, you can set alerts that sound a tone.

Fade

The fade alert sounds a tone when any network drops a call.

To set the fade alert

1. From standby mode, press **▲** **menu**.
2. Press **pqrs 7** for Preferences.
3. Press **def 3** for Alerts.
4. Press **1** for Fade.
5. Scroll to select "on" or "off."
6. Press **▲** **ok**.

Minute

The minute alert sounds a tone ten seconds before the end of every minute.

To set the minute alert

1. From standby mode, press **▲** **menu**.
2. Press **pqrs 7** for Preferences.
3. Press **def 3** for Alerts.
4. Press **abc 2** for Minute.
5. Scroll to select "on" or "off."
6. Press **▲** **ok**.

Service Change

This alert sounds a tone and displays a message when the phone enters or leaves service.

To set the service change alert

1. From standby mode, press menu.
2. Press for Preferences.
3. Press for Alerts.
4. Press for Service.
5. Scroll to select "on" or "off."
6. Press ok.

New Message

The new message alert sounds a tone when you receive a new text message or voice mail notification.

To set the new message alert

1. From standby mode, press menu.
2. Press for Preferences.
3. Press for Alerts.
4. Press for New Message.
5. Scroll to select one of the following:
 - Off – Phone does not sound a beep when a new message is received
 - Once – Phone sounds one beep when a new message is received
 - Periodic – Phone sounds a beep periodically when a new message is received until you retrieve the message by pressing
6. Press ok.

Calling

You can set the Calling features to automatically answer the phone or redial a busy number. You can also set one-touch dial or any-key answer to "on."

Auto Answer

You can set the number of times the phone rings before it automatically answers a call. If you use this feature, your phone's ringer is automatically set to Standard.

To set auto answer

1. From standby mode, press menu.
2. Press for Preferences.
3. Press for Calling.
4. Press for AutoAnswer.

5. Scroll to select one of the following:
 - Off – Phone does not automatically answer
 - After 1 ring – Phone automatically answers after 1 ring
 - After 2 rings – Phone automatically answers after 2 rings
 - Car kit only 1 ring – Phone automatically answers when installed in the car kit after 1 ring
 - Car kit only 2 rings – Phone automatically answers when installed in the car kit after 2 rings
6. Press **▲** **ok**. If you select an option other than “off,” the message “-Auto Answer-” alternates on the screen with the time while in standby mode.

Auto Redial

You can use this feature to set the time interval in which the phone automatically redials a number when the network is busy or unavailable, but not when the phone line is busy. While the phone is in standby mode, the phone automatically redials at that interval until the call connects or you press **END**. If you change service, auto redial stops.

To set auto redial

1. From standby mode, press **▲** **menu**.
2. Press **pqrs 7** for Preferences.
3. Press **ghi 4** for Calling.
4. Press **abc 2** for Auto Redial.
5. Scroll to select one of the following:
 - Off – Do not automatically redial
 - Every 10 seconds – Automatically redial every 10 seconds
 - Every 30 seconds – Automatically redial every 30 seconds
 - Every 60 seconds – Automatically redial every 60 seconds
6. Press **▲** **ok**.

One-Touch Dial

If you set one-touch dial to “on,” you can dial any of the 99 phone book location numbers without pressing **SEND**.

To set one-touch dial

1. From standby mode, press **▲** **menu**.
2. Press **pqrs 7** for Preferences.
3. Press **ghi 4** for Calling.
4. Press **def 3** for One-Touch Dial.
5. Scroll to select “yes” or “no.”
6. Press **▲** **ok**.

See One-touch dialing, page 22, for more information.

Any-Key Answer

With this feature, you can press any key to answer an incoming call while in standby mode, except **Pwr** or **END**. If this feature is not set to “yes,” press **SEND** to answer calls.

To set any-key answer

1. From standby mode, press **▲** menu.
2. Press **pqrs 7** for Preferences.
3. Press **ghi 4** for Calling.
4. Press **ghi 4** for AnyKeyAnsw.
5. Scroll to select “yes” or “no.”
6. Press **▲** ok.

Send PIN

If your cellular service provider supports this feature, you can use a PIN (personal identification number) for verification before connecting analog calls.

To enter your own PIN, see Entering PIN, page 38. Contact your cellular service provider for more information.

Each PIN is associated with a different NAM (number assignment module), or phone number. When you enter a PIN, it becomes associated with the currently selected NAM, so be sure to select the appropriate NAM before setting Send PIN (see NAM Select, page 57).

To set Send PIN

1. From standby mode, press **▲** menu.



Note

Be sure to select the appropriate NAM before setting Send PIN (see NAM Select, page 57).

2. Press **pqrs 7** for Preferences.
3. Press **ghi 4** for Calling.
4. Press **mno 6** for Send PIN.
5. Scroll to select one of the following:
 - Never – Does not prompt you for or send a PIN
 - Prompt – Prompts you for a PIN after you enter the phone number
6. Press **▲** ok.

8 System

- 1 Status
- 2 Find Home
- 3 Version
- 4 Service Provider Select
 - 1 Known List
 - 2 Preferred List
 - 3 Prohibited List
 - 4 Force Service Provider Selection
- 5 Service Provider
- 6 Territory
- 7 Manual Mode
 - 1 Auto Mode
 - 2 Globalstar
 - 3 Digital
 - 4 Analog
- 8 Auto Mode
- 9 NAM Select
 - 1 Auto NAM
 - 2 Set NAM
 - 3 Set System

9 My Numbers



- Phone Number 1
- Phone Number 2
- Phone Number Globalstar

Status

When your phone is in Globalstar satellite mode, this feature provides status for the state of the phone's Globalstar satellite antenna, car kit, security module, battery, memory, lock, and self-test:

- ☺ Indicates a good condition or ready for use
- ☹ Indicates a faulty condition or not ready for use
- – Indicates not in use

To access status information

1. From standby mode, press  menu.
2. Press  for System.
3. Press  for Status:
 - Antenna Up – If ☺ displays, the Globalstar satellite antenna is rotated properly. If the antenna is rotated and ☹ displays, contact your satellite service provider.
 - Car Kit – If ☺ displays, the car kit is operating properly. If ☹ displays, reconnect the phone in the cradle or contact the installation technician.
 - Battery – If ☺ displays, the battery is installed properly. If ☹ displays, remove and replace your battery or contact your satellite service provider.
 - Security – If ☺ displays, the valid security module is inserted properly. (There may be a brief delay in displaying ☺.) If ☹ displays, contact your satellite service provider.
 - Memory – If ☺ displays, there is enough available phone memory. If ☹ displays, delete text messages and voice mail notifications.

- Unlocked – If ☺ displays, the satellite or cellular service provider has not locked your phone. If ☹ displays, contact your service provider.
 - Self-test – If ☺ displays, the phone has made a successful self-test. If ☹ displays, contact your satellite or cellular service provider.
4. Press **Clr** or **END**.

Find Home

With this feature, you can quickly find your home satellite service provider. The phone disconnects and attempts to find your home satellite service provider, if available. If not, the phone attempts to find service based on your Auto Mode selection (see Auto Mode, page 56). This feature is helpful if you want to stop roaming.

To force the phone to find home

1. From standby mode, press **▲** menu.
2. Press **tuv 8** for System.
3. Press **abc 2** for Find Home.
4. Press **▲** ok.

Version

This feature displays the version number of the software installed on your phone.

To display the software version number

1. From standby mode, press **▲** menu.
2. Press **tuv 8** for System.
3. Press **def 3** for Version.
4. Scroll to read the information.
5. Press **Clr** or **END**.

Service Provider Select

This feature allows you to select satellite service providers and force service provider selection. Three lists are used to select satellite service providers:

- Known List – Shows all of the known satellite service providers that you can add to the Preferred or Prohibited Lists. This list is programmed by the satellite service provider. New satellite service providers are automatically added as they become available.
- Preferred List – Shows your preferred order of priority for satellite service providers. Always shows the home satellite service provider highlighted first on the screen. The number to the left of the satellite service provider name identifies the order of priority.

- Prohibited List – Shows the satellite service providers in alphabetical order that you choose *not* to use. You cannot add the home satellite service provider to this list.

**Note**

You cannot add or delete your home service provider from any list.

When you look at the Known List, satellite service providers you have placed on other lists display as follows:

- Satellite service providers placed on the Preferred List are highlighted.
- Satellite service providers placed on the Prohibited List are crossed out.
- Satellite service providers placed on both the Preferred and Prohibited Lists are highlighted and crossed out.

Registering phone

Registration means your phone is looking for service and obtains service after network approval. If the service change alert is set to “on,” the alert sounds a tone and displays a menu when the phone enters or leaves service. (See Service Change, page 47.) After your phone is registered and an **I** displays on the screen, press **Info** for service provider information and the current phone number.

Changes made to the Preferred or Prohibited Lists do not take effect until the phone is registered again with the network. To register the phone, do one of the following:

- Turn the phone on and off
- Find your home satellite service provider (see Find Home, page 52)
- Force service provider selection (see Force Service Provider Selection, page 55)

If you add the currently registered satellite service provider to the Prohibited List, the phone will automatically reregister.

Viewing lists**To view the Known, Preferred, or Prohibited Lists**

1. From standby mode, press **▲** menu.
2. Press **tuv 8** for System.
3. Press **ghi 4** for SP (service provider) Select.
4. Press **1** for Known List, **abc 2** for Prefr List, or **def 3** for Prohb List.

5. Press **▲** **view** to display the satellite service provider's MCC (mobile country code) and MNC (mobile network code).
 - If the satellite service provider is on the Preferred List, the preferred location number displays (Pref Loc).
 - If the satellite service provider is on the Prohibited List, "yes" displays (Prohib).
 - If the satellite service provider is on both the Preferred and the Prohibited Lists, the preferred location number and "yes" displays.
6. Press **▲** **ok**.

Adding to lists

To add to the Preferred or Prohibited Lists

1. From standby mode, press **▲** **menu**.
2. Press **tuv 8** for System.
3. Press **ghi 4** for SP (service provider) Select.
4. Press **1** for Known List.
5. Scroll to select a satellite service provider.
6. Press **▲** **edit**.
7. Press **1** for Preferred or **abc 2** for Prohibited.
8. Press **▲** **ok**.
9. Reregister your phone (see Registering phone, page 53).

Editing lists

To edit (reorder or delete) from the Preferred List

1. From standby mode, press **▲** **menu**.
2. Press **tuv 8** for System.
3. Press **ghi 4** for SP (service provider) Select.
4. Press **abc 2** for Prefr List.
5. Scroll to select a satellite service provider.
6. Press **▲** **edit**.
7. Do one of the following:
 - Press **1** for Reorder, scroll to move the selected satellite service provider to a new position, and press **▲** **ok**.
 - Press **abc 2** for Delete, and press **▲** **ok** to delete the selected satellite service provider from the list.
8. Press **▲** **ok**.
9. Reregister your phone (see Registering phone, page 53).

Erasing from Prohibited List

1. From standby mode, press **▲** **menu**.
2. Press **tuv 8** for System.
3. Press **ghi 4** for SP (service provider) Select.

4. Press **(def 3)** for Prohb List.
5. Scroll to select a satellite service provider.
6. Press **(▲)** **erase**.
7. Press **(▲)** **ok**.
8. Reregister your phone (see Registering phone, page 53).

Force Service Provider Selection

This feature forces the phone to register with a satellite service provider in the following order of priority:

1. The phone attempts to register with your home satellite service provider.
2. The phone attempts to register with satellite service providers on the Preferred List.
3. The phone attempts to register with satellite service providers on the Known List.

To force satellite service provider selection

1. From standby mode, press **(▲)** **menu**.
2. Press **(tuv 8)** for System.
3. Press **(ghi 4)** for SP (service provider) Select.
4. Press **(ghi 4)** for Force SPS (service provider selection).
5. Press **(▲)** **ok**.

Service Provider

To display the current satellite service provider's name

1. From standby mode, press **(▲)** **menu**.
2. Press **(tuv 8)** for System.
3. Press **(jkl 5)** for SrvcPrvder.
4. Press **(Clr)** or **(END)**.

Territory

This feature displays the current satellite service provider's MCC (mobile country code) and MNC (mobile network code).

To display the territory information

1. From standby mode, press **(▲)** **menu**.
2. Press **(tuv 8)** for System.
3. Press **(mno 6)** for Territory.
4. Press **(Clr)** or **(END)**.

Manual Mode

The phone operates in Globalstar satellite, digital, or analog mode. You can manually select one of these modes or select auto mode by using this feature. Auto mode means that the phone automatically selects a mode based on your auto mode setting (see Auto Mode, page 56).

The mode you select remains selected until you turn the phone off, and then it resets to your auto mode setting. If one of the modes is currently unavailable, it will not display on the screen.

To manually select a mode

1. **Shortcut:** From standby mode, press and hold *** ↑**. The following displays:



2. Press:

- **1** to select Auto Mode. The message “Initiating Automatic System Acquisition” displays.
- **abc 2** for Globalstar satellite mode. The message “Initiating Globalstar System Acquisition” displays.
- **def 3** for Digital mode. The message “Initiating Digital System Acquisition” displays.
- **ghi 4** for Analog mode. The message “Initiating Analog System Acquisition” displays.





Auto Mode

You can set each phone number (or NAM) to automatically look for service using one or more modes in the order of priority that you specify:

- GStar only – Look for Globalstar satellite service only.
- Cell only – Look for cellular service only. For cellular service (cell only), you choose between digital or analog using the Cell Pref menu.
- GStar Pref – Attempt to look for Globalstar satellite service first and cellular service last.
- Cell Pref – Attempt to look for cellular service first and Globalstar satellite service last.

To set auto mode

1. Select the appropriate NAM (see NAM Select, page 57).
2. From standby mode, press **▲** **menu**.
3. Press **tuv 8** for System.
4. Press **tuv 8** for Auto Mode

5. Scroll to select one of the following:
 - GStar Only – Look for Globalstar satellite service only. Press  **ok**, and the phone returns to standby mode.
 - Cell Only – Look for cellular service only. Press  **ok**, and the Cell Pref menu displays. Go to Step 6.
 - GStar Pref – Look for Globalstar satellite service first and either digital or analog mode last. Press  **ok**, and the Cell Pref menu displays. Go to Step 6.
 - Cell Pref – Look for cellular service first and Globalstar last. Press  **ok**, and the Cell Pref menu displays. Go to Step 6.
6. If the Cell Pref menu displays, scroll to select one of the following:
 - Analg Only – Prefer analog service only
 - Digtl Only – Prefer digital service only
 - Digtl Pref – Prefer digital service over analog
 - Analg Pref – Prefer analog service over digital
7. Press  **ok**.

NAM Select





The phone allows one Globalstar NAM (number assignment module), or phone number, and two different cellular-only NAMs. The NAMs are entered into the phone by your service providers. (See My Numbers, page 58, to display the NAMs entered.)

Before making or receiving calls, you must activate a NAM, but only one can be active at a time. With this feature, you can access these options:

- Auto NAM – Automatically switches NAMs, if appropriate, during system searches to look for home area service.
- Set NAM – Manually sets the NAM.
- Set System – Sets your system preference for each NAM. Set System only affects cellular service. It does not affect Globalstar service.

Your service provider can configure the Globalstar NAM for both Globalstar and cellular service (digital and analog). In Globalstar mode, the phone always uses the Globalstar NAM. In cellular mode, the phone uses the selected cellular NAM (NAM1, NAM2, or G*NAM).

To set Auto NAM

1. From standby mode, press  **menu**.
2. Press  for System.
3. Press  for NAM Select.
4. Press  for Auto NAM.
5. Scroll to select “yes” or “no.”
6. Press  **ok**.

To set the NAM

1. From standby mode with Auto NAM set to “no,” press **▲** menu.
2. Press **tuv 8** for System.
3. Press **wxyz 9** for NAM Select.
4. Press **abc 2** for Set NAM.
5. Scroll to select the NAM.
6. Press **▲** ok.

To set the system

1. Select the appropriate NAM (see NAM Select, page 57).
2. From standby mode, press **▲** menu.
3. Press **tuv 8** for System.
4. Press **wxyz 9** for NAM Select.
5. Press **def 3** for Set System.
6. Scroll to select one of the following:
 - Automatic – Use home system, but if not found use another system
 - No Roaming – Use only the home system
 - A only – Use cellular “A” system only
 - B only – Use cellular “B” system only

My Numbers

You can display your three phone numbers (NAMs) and service provider name. (The NAMs are entered by your service provider. See NAM Select, page 57.)

To display your three phone numbers

1. From standby mode, press **▲** menu
2. Press **wxyz 9** for My Numbers.
3. Scroll to select one of the following:
 - PhoneNo 1 – Displays cellular phone number
 - PhoneNo 2 – Displays cellular phone number
 - PhoneNo G* – Displays Globalstar satellite phone number

Battery Care and Maintenance

Learn about battery care, battery charging, and battery removal and replacement in this section.

Battery

The phone comes with a rechargeable battery that is located on the back of the phone:

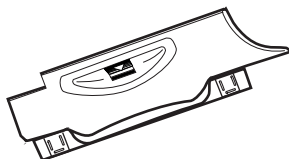

The following is typical battery performance:

Service Mode	Talk Time	Standby Time
Globalstar satellite	3.5 hours	9 hours
Digital	4.5 hours	72 hours
Analog	2.5 hours	14 hours

Battery care and charging

The battery charge level indicator is shown at the top right of the screen and ranges between four diagonal bars (full charge) to one bar (minimal charge). If the indicator has one blinking bar, the battery has no charge.



Fully charge the battery immediately after purchasing the phone to maximize the talk and standby times. The battery does not need to be completely drained before you recharge it. See Low battery, page 60, for more information.

Follow these guidelines for batteries:

- Only use QUALCOMM batteries and chargers designed for your phone. Do not use any other battery or charger. You cannot overcharge QUALCOMM batteries with QUALCOMM chargers.
- To maximize battery life, set the backlight option to "off" (see Backlight, page 42).

- To prevent damage, do not charge the battery in temperatures less than +32 °F (0 °C) or greater than +104 °F (+40 °C). Do not use the battery in temperatures less than -4 °F (-20 °C) or greater than +140 °F (+60 °C).
- Do not use the battery charger in direct sunlight or in places with excessive humidity, such as a bathroom.
- Keep the metal contacts at the top end of the battery clean.
- Never dispose of the battery in a fire or trash compactor.
- Do not try to disassemble or short circuit the battery.
- Recharge the battery if the phone has not been used for several months.
- Do not store batteries in places where temperatures are below -22 °F (-30 °C) or above +140 °F (+60 °C).

Battery chargers

Charge the batteries with the AC wall charger, universal travel charger, or cigarette lighter adapter (see Accessories, page 67).



Note

When using the AC wall charger, plug the charger into the power source first, and then into the phone.

You can use the phone while charging the battery. However, it will charge more quickly if the phone is turned off. The battery does not need to be completely drained before you recharge it.

The universal travel charger allows you to charge the battery while it is attached to the phone whether the phone is turned on or off. You can also charge another battery at the same time.

After you connect the phone to one of the chargers, check the charging status:

- If the battery is charging, a message displays and the bars on the battery indicator  flash in sequence.
- If the phone is turned off, a message displays on the screen when charging is complete.

The typical charge time to 90% charge level for the universal travel charger, cigarette lighter adapter, or AC wall charger is 2-1/2 hours.

Low battery

The phone alerts you when the battery is low. To turn off the battery alert, set the ringer volume to zero (0).

- The battery indicator flashes.
- The phone beeps three times (if you are on a call, the phone continues to beep every minute).
- The message “Low Battery! Recharge Battery Soon” displays on the screen.

If the battery level gets too low, the phone turns off and loses any function in progress. Before turning off, the phone alerts you with five beeps and the message “Low Battery, Turning Off Phone Now” displays on the screen.

Battery removal

1. Turn the power off to avoid losing data.
2. Press and hold the battery release latch in the direction of the arrow to release it from the phone.

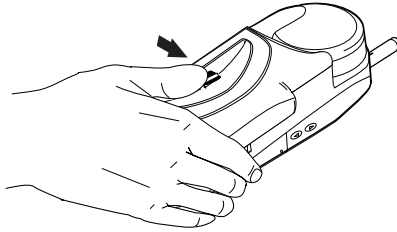

Battery replacement

1. If a battery is already installed, turn the power off to prevent losing data and then remove the battery.
2. Insert the new replacement battery by lining up the positioning tabs (see arrows) and rotating it into place.
3. Press down on the battery until it locks.

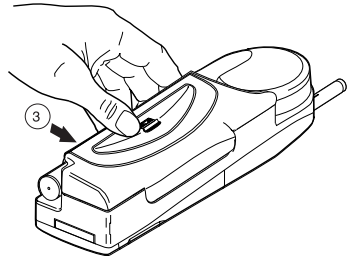
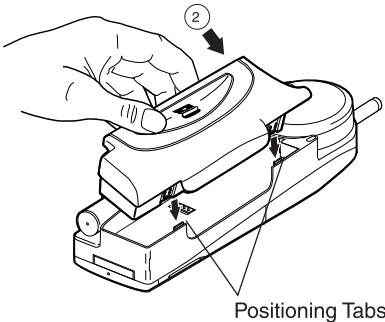

Learn the safety information for wireless handheld phones in this section.

Exposure to radio frequency signals

Your wireless handheld portable telephone is a low power radio transmitter and receiver. When it is ON, it receives and also sends out radio frequency (RF) signals.

In August, 1996, the Federal Communications Commissions (FCC) adopted RF exposure guidelines with safety levels for hand-held wireless phones. Those guidelines are consistent with the safety standards previously set by both U.S. and international standards bodies:

- ANSI C95.1 (1992)¹
- NCRP Report 86 (1986)²
- ICNIRP (1996)³

Those standards were based on comprehensive and periodic evaluations of the relevant scientific literature. For example, over 120 scientists, engineers, and physicians from universities, government health agencies, and industry reviewed the available body of research to develop the ANSI Standard (C95.1).

The design of your phone complies with the FCC guidelines (and those standards).

Antenna care

Use only the supplied or an approved replacement antenna. Unauthorized antennas, modifications, or attachments could damage the phone and may violate FCC regulations.

Phone operation

Normal POSITION: Hold the phone as you would any other telephone with the antenna pointed up and over your shoulder.

TIPS ON EFFICIENT OPERATION: For your phone to operate most efficiently:

- Extend your antenna fully.
- Do not touch the antenna unnecessarily when the phone is in use. Contact with the antenna affects call quality and may cause the phone to operate at a higher power level than otherwise needed.

-
1. American National Standards Institute
 2. National Council on Radiation Protection and Measurements
 3. International Commission on Non-Ionizing Radiation Protection

Driving

Check the laws and regulations on the use of wireless telephones in the areas where you drive. Always obey them. Also, if using your phone while driving, please:

- Give full attention to driving – driving safely is your first responsibility;
- Use hands-free operation, if available;
- Pull off the road and park before making or answering a call if driving conditions so require.

Electronic devices

Most modern electronic equipment is shielded from RF signals. However, certain electronic equipment may not be shielded against the RF signals from your wireless phone.

Pacemakers

The Health Industry Manufacturers Association recommends that a minimum separation of six (6") inches be maintained between a handheld wireless phone and a pacemaker to avoid potential interference with the pacemaker. These recommendations are consistent with the independent research by and recommendations of Wireless Technology Research.

Persons with pacemakers:

- Should ALWAYS keep the phone more than six inches from their pacemaker when the phone is turned ON;
- Should not carry the phone in a breast pocket;
- Should use the ear opposite the pacemaker to minimize the potential for interference.
- If you have any reason to suspect that interference is taking place, turn your phone OFF immediately.

Hearing aids

Some digital wireless phones may interfere with some hearing aids. In the event of such interference, you may want to consult your service provider.

Other medical devices

If you use any other personal medical device, consult the manufacturer of your device to determine if they are adequately shielded from external RF energy. Your physician may be able to assist you in obtaining this information.

Turn your phone OFF in health care facilities when any regulations posted in these areas instruct you to do so. Hospitals or health care facilities may be using equipment that could be sensitive to external RF energy.

Vehicles

RF signals may affect improperly installed or inadequately shielded electronic systems in motor vehicles. Check with the manufacturer or its representative regarding your vehicle. You should also consult the manufacturer of any equipment that has been added to your vehicle.

Posted facilities

Turn your phone OFF in any facility where posted notices so require.

Aircraft

FCC regulations prohibit using your phone while in the air.

Switch OFF your phone before boarding an aircraft.

Blasting areas

To avoid interfering with blasting operations, turn your phone OFF when in a "blasting area" or in areas posted: "Turn off two-way radio". Obey all signs and instructions.

Potentially explosive atmospheres

Turn your phone OFF when in any area with a potentially explosive atmosphere and obey all signs and instructions. Sparks in such areas could cause an explosion or fire resulting in bodily injury or even death.

Areas with a potentially explosive atmosphere are often but not always clearly marked. They include fueling areas such as gasoline stations; below deck on boats; fuel or chemical transfer or storage facilities; vehicles using liquefied petroleum gas (such as propane or butane); areas where the air contains chemicals or particles, such as grain, dust, or metal powders; and any other area where you would normally be advised to turn off your vehicle engine.

For vehicles equipped with an air bag

An air bag inflates with great force. DO NOT place objects, including both installed or portable wireless equipment, in the area over the air bag or in the air bag deployment area. If in-vehicle wireless equipment is improperly installed and the air bag inflates, serious injury could result.

Battery care

The phone's battery stores a large amount of energy when fully charged. If the battery is punctured, crushed, severely overheated, or charged in a non-QUALCOMM charger, this energy can be released suddenly and result in potential injury. Do not overheat the battery by leaving it on a heater or in the sun, and do not dispose of the battery in a trash compactor or incinerator. Use only charging accessories manufactured by QUALCOMM, and discontinue use of the battery if it becomes damaged.

Other safety issues

In order to avoid the potential for confusing the phone as a weapon, the phone features a distinctive flame orange band at the tip of the antenna, which is a convention used by manufacturers of various devices and is familiar to safety officers in the country of manufacture and other countries. Do not remove or cover the band, and avoid using or handling the phone in a threatening manner or so as to suggest that the phone is a weapon.

The optional accessories described in this section are available from your satellite or cellular service provider.



Caution

**Allow only authorized personnel to service the accessories.
Unauthorized service can invalidate the warranty.**

Battery

An extra battery allows you to have a charged battery available at all times.

Leather case

A leather case with a wrist strap protects your phone and provides carrying convenience.

AC wall charger

The North American and European version AC wall chargers supply power to the phone and fast charge the battery while it is attached to the phone. Both chargers operate at 110V and 220V.

Universal travel charger

The universal travel charger allows you to charge a battery attached to the phone. At the same time, you can charge a battery detached from the phone and installed in the universal travel charger. Three optional plugs are available to adapt the universal travel charger for use in different countries.

Cigarette lighter adapter

The cigarette lighter adapter supports both U.S. and European vehicles. For European vehicles, insert the adapter into the sleeve.

Plug the adapter into your vehicle's cigarette lighter to supply power to the phone (with or without the battery attached). You can also fast charge the battery at the same time.

Data cables

Various data cables or adaptors are available that allow you to connect your phone directly to IBM® PC-compatible computers, Apple® Macintosh® computers, Palm™ handheld, or UNIX®-based computers. See the QUALCOMM Globalstar packet data kit user documentation that comes with your data cable for more information.

Hands-free car kit

With the QUALCOMM Globalstar Hands-Free Car Kit, you can adapt your phone for hands-free operation in your vehicle. For more information, see the QUALCOMM Globalstar hands-free car kit user documentation.



Caution

Allow only authorized personnel to install or service the car kit. Faulty installation or service can be dangerous and can invalidate the warranty.

Troubleshooting

If you have a problem with your phone that you cannot solve by following these troubleshooting tips, contact your satellite or cellular service provider. (You may have different service providers for Globalstar satellite service and cellular service.)

Problem	Solution
Turning the phone on	<ul style="list-style-type: none">■ Hold  for more than one second.■ Check the battery installation.■ Recharge or replace the battery.
Charging the battery	<ul style="list-style-type: none">■ Install only QUALCOMM batteries.■ Check that the battery contacts are clean and dry.■ Check the charger connection.■ If the battery does not charge at first, remove the charger plug from the phone, wait ten seconds, and then reinsert the plug.■ Check the battery temperature. If it is too warm, allow it to cool before recharging it.■ Replace the battery if it is several years old.
Battery draining quickly	<ul style="list-style-type: none">■ Check that your Globalstar satellite antenna is pointing straight up and has a clear view of the sky to conserve battery life.■ Set the backlight option to "off" (see Backlight, page 42).■ Replace the battery if it is several years old.■ Check the battery temperature. If temperatures are too warm or too cold, battery life is decreased.

Problem	Solution
Making calls	<ul style="list-style-type: none"> ■ Rotate or fully extend the appropriate antenna. ■ In Globalstar satellite mode, be sure the satellite antenna has a clear view of the sky. ■ Check that you selected the correct service mode: <p style="margin-left: 20px;"><i>Globalstar:</i> Press and hold (*) to display the mode menu, and press (abc 2) for Globalstar.</p> <p style="margin-left: 20px;"><i>Cellular:</i> Press and hold (*) to display the mode menu, and press (def 3) for Digital or (ghi 4) for Analog.</p> ■ Remove all service providers from the Prohibited List (see Erasing from Prohibited List, page 54). ■ If “Service Not Found” displays, check the auto preference and mode selection settings (see Auto Mode, page 56, and Manual Mode, page 56). ■ Check the signal strength indicator. ■ Check that the security module is properly installed. If the security module was removed, turn the phone off and on. ■ If “Calling is Restricted” displays, check the Restrict Phone setting under the Security menu.

Problem	Solution
Receiving calls	<ul style="list-style-type: none"> ■ Check that the phone is turned on. ■ Check that the ringer is loud enough. ■ Rotate or fully extend the appropriate antenna. ■ In Globalstar satellite mode, be sure that the satellite antenna has a clear view of the sky. ■ Check that you selected the correct service mode: <i>Globalstar:</i> Press and hold (*) to display the mode menu, and press (abc 2) for Globalstar. <i>Cellular:</i> Press and hold (*) to display the mode menu, and press (def 3) for Digital or (ghi 4) for Analog. ■ Remove all service providers from the Prohibited List (see Erasing from Prohibited List, page 54). ■ Check the signal strength indicator. ■ Check that the security module is properly installed. If the security module was removed, turn the phone off and on.
Losing calls	<ul style="list-style-type: none"> ■ In Globalstar satellite mode, be sure that your satellite antenna is pointing straight up when placed next to your head and when using the keypad or viewing the screen. ■ In Globalstar satellite mode, be sure that the satellite antenna has a clear view of the sky. ■ Rotate or fully extend the appropriate antenna. ■ Check the signal strength indicator.
Remembering your lock code or PIN (personal identification number)	<ul style="list-style-type: none"> ■ Contact your satellite or cellular service provider for the lock code for the Security menu or phone lock feature. ■ Contact your cellular service provider for the PIN used to make analog calls.

- A**
- AC wall charger 67
- accessories 67
- adaptors, data 67
- air bag safety 65
- alerts 46
 - fade 46
 - minute 46
 - new message 47
 - service change 47
- all calls 32
- analog mode indicator 9
- answering calls 5, 6
- antenna 10
 - cellular 4
 - safety 63
 - satellite 2, 3
- any-key answer 49
- auto answer 47
- auto hyphen
 - pauses 18
- auto hyphens 43
- auto mode 56
- auto NAM 57
- B**
- backlight, settings 42
- banner 43
- battery
 - charge indicator 59
 - charge time 60
 - charger indicator 9
 - chargers 60
 - charging 59
 - decrease life 42
 - guidelines 59
 - increase life 42
 - low charge 60
 - removal 61
 - replacement 61
 - typical performance 59
- C**
- call history
 - accessing 23
 - call types 23
 - erasing 37
 - viewing details 24
- call in progress indicator 9
- call information menu 31
 - all calls 32
 - data calls 32
 - home calls 31
 - last call 31
 - recent calls 32
 - roam calls 31
- call waiting 14
- caller ID 14
- calls
 - emergency 13
 - making cellular calls 4
 - making satellite calls 4
 - missed 6
 - redialing 13
- cellular antenna 10
 - extending 4
- cellular mode 1, 56
- charger
 - universal travel 67
 - wall 67
- charging battery 59, 60
- check mark indicator 9
- cigarette lighter adapter 67
- clear key 16
 - defined 8
- counter
 - resetting 33
 - undo resetting 33
- D**
- data cables 67
- data calls 32
 - adaptors 67
 - data cables 67
 - making 5
 - set baud rate 30
- deleting
 - letters 17
 - numbers 12
- digital mode indicator 9
- displaying phone number 6
- driving safety 64
- DTMF tones 21, 24

- E**
- earpiece volume 40
- editing
 - banner 43
 - letters 17
 - numbers 12
 - phone book entries 20
- electronic devices 64
- emergency calls 13
- encryption 9
- end key 16
 - defined 8
- ending calls 6
- entering
 - hyphens 43
 - letters 17
 - numbers 12
 - pauses 18
 - priority numbers 36
 - punctuation 17
 - spaces 17
- erasing
 - all phone book entries 37
 - all SMS messages 37
 - call history list 37
 - phone book entries 20
- F**
- fade alert 46
- features menu 29
 - key guard 29
 - scratchpad 29
- find home 52
- finding phone book entries 19
- force service provider selection 55
- G**
- Globalstar satellite mode 1, 56
- Globalstar time zone 44, 45
- H**
- hands-free car kit 68
- hard pauses 18
- hearing aids 64
- home calls 31
- hyphens
 - entering automatically 43
 - entering manually 43
- I**
- indicator
 - analog mode 9
 - battery charge 9
 - call in progress 9
 - check mark 9
 - digital mode 9
 - light, defined 7
 - locked message 9
 - no service 9
 - roaming 9
 - satellite mode 9
 - scroll arrows 9
 - signal strength 9
 - text message 9
 - unlocked message 9
 - voice message 9
- information key 8, 10
- international dialing 13
- K**
- key beep length 41
- key beep sound 40
- key beep volume 41
- key guard 29
- key presses 1
- keypad 7
- known list 52, 53
- L**
- language 46
- last call 31
- lists
 - known 52
 - preferred 52
 - prohibited 53
- lock code, about 35
- lock code, changing 36
- locked message indicator 9
- locking messages 27, 28
- locking phone 35
- M**
- main menu 16
- manual mode 56
 - shortcut 2
- medical devices 64
- memory 27, 28
 - text message 27
- menu
 - call history 23
 - call information 31
 - features 29
 - messages 25
 - my numbers 58
 - phone book 17

- preferences 39
 - security 35
 - system 51
 - messages 25
 - call back numbers 27
 - calling voice mail system 26
 - erasing text 27
 - locking 27, 28
 - storing 27
 - text 26
 - unlocking 28
 - voice mail notifications 25
 - messages menu 25
 - minute alert 46
 - mode
 - cellular 1, 56
 - power save 12
 - satellite 1, 56
 - standby 11
 - mute phone 13
 - mute stereo 41, 42
 - my numbers 58
- N**
- NAM Select
 - setting auto NAM 57
 - setting NAM 58
 - setting system 58
 - navigating menus 16
 - new message alert 47
 - no service indicator 9
 - numbers
 - deleting 12
 - editing 12
 - entering 12
- O**
- one-touch dial
 - setting 48
 - using 22
 - one-touch dialing
 - setting 48
- P**
- pacemakers 64
 - pauses 18
 - entering 18
 - phone book
 - editing entries 20
 - erasing all entries 37
 - erasing entries 20
 - finding entries 19
 - nonsecret entries 20
 - saving entries 18
 - secret entries 20
 - view or change secret entries 21
 - viewing numbers 21
 - phone book menu 17
 - phone lock 35
 - phone number, displaying 6
 - PIN
 - entering 38
 - sending 49
 - plus key dialing 13
 - power save mode 12
 - preferences menu 39
 - alerts 46
 - calling 47
 - display 42
 - sounds 39
 - preferred list 52
 - adding 54
 - deleting 54
 - editing 54
 - reordering 54
 - viewing 53
 - prepend 21
 - priority numbers 36
 - privacy 9
 - prohibited list 53
 - adding 54
 - erasing 54
 - viewing 53
- R**
- radio frequency 63
 - receiving calls 5
 - recent calls 32
 - redial
 - auto 48
 - manual 13
 - registering phone 53
 - removing battery 61
 - reordering preferred list 54
 - replacing battery 61
 - resetting call counters 33
 - resetting preferences 38
 - restricting phone 36
 - ringer silencing 40
 - ringer type 39
 - ringer volume 39
 - roam calls 31
 - roaming 4, 52
 - indicator 9

- S**
 - safety
 - air bags 65
 - aircraft 65
 - antenna 63
 - blasting areas 65
 - driving 64
 - electronic devices 64
 - explosive atmospheres 65
 - hearing aids 64
 - hospitals 64
 - medical devices 64
 - pacemakers 64
 - radio frequency 63
 - satellite antenna 2, 3, 10
 - satellite calls
 - making 4
 - preparing for 2
 - satellite mode 1, 56
 - satellite mode indicator 9
 - saving menu changes 16
 - scratchpad 29
 - scroll arrows 9
 - scroll keys 1, 8
 - secret entries 20
 - security menu 35
 - enter PIN 38
 - erase call history 37
 - erase phone book 37
 - erase SMS messages 37
 - lock phone 35
 - new code 36
 - priority numbers 36
 - resetting preferences 38
 - restricted 36
 - unlock phone 35
 - security module 2, 10
 - sending PIN 49
 - sending tones 21
 - call history 24
 - manually 22
 - phone book 22
 - scratchpad 29
 - service alert 47
 - service provider
 - accessing information 55
 - force selection 55
 - select 52
 - show time 44
 - signal strength indicator 9
 - silence ringer 40
 - SMART KEY buttons 8
 - SMART KEY options 1, 8
 - SMS messages
 - about 25
 - erasing entries 37
 - SMS time 45
 - software version 52
 - sound 39
 - speed dialing 22
 - standby mode 11
 - standby time 59
 - status 51
 - stereo muting 41, 42
 - system menu 51
 - auto mode 56
 - find home 52
 - manual mode 56
 - NAM select 57
 - service provider 55
 - service provider select 52
 - status 51
 - territory 55
 - version 52
- T**
 - talk time 59
 - territory 55
 - text message indicator 9
 - three-way calling 14
 - time
 - showing 44
 - SMS 45
 - time zone, Globalstar 44, 45
 - timed pauses 18
 - tones
 - DTMF 21
 - sending 21
 - sending by phone book 22
 - sending manually 22
 - turning phone on 11
- U**
 - undo counter 33
 - universal travel charger 67
 - unlocked message indicator 9
 - unlocking messages 28
 - unlocking phone 35

V

version 52

voice mail 26

voice mail notifications 25

voice message indicator 9

voice messages 25

volume buttons 8

W

wall charger 67

Free Manuals Download Website

<http://myh66.com>

<http://usermanuals.us>

<http://www.somanuals.com>

<http://www.4manuals.cc>

<http://www.manual-lib.com>

<http://www.404manual.com>

<http://www.luxmanual.com>

<http://aubethermostatmanual.com>

Golf course search by state

<http://golfingnear.com>

Email search by domain

<http://emailbydomain.com>

Auto manuals search

<http://auto.somanuals.com>

TV manuals search

<http://tv.somanuals.com>