

QUANTUM 

Qflash[®]
"5d-R" series
Digital Flash
Models QFT5d-R, QFX5d-R
Operating Instructions

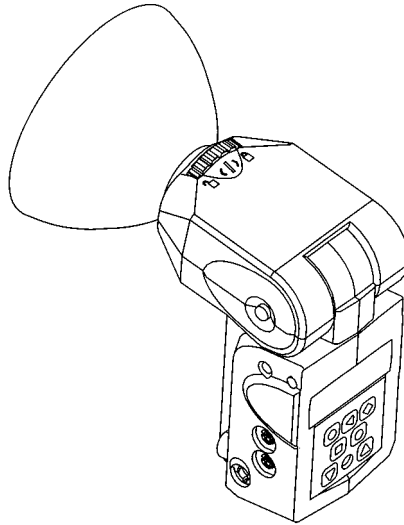

QFT5d-R-- powered by Quantum Turbo® batteries
QFX5d-R-- powered by Quantum Qpaq System

Quantum Instruments
Designed and manufactured in the USA

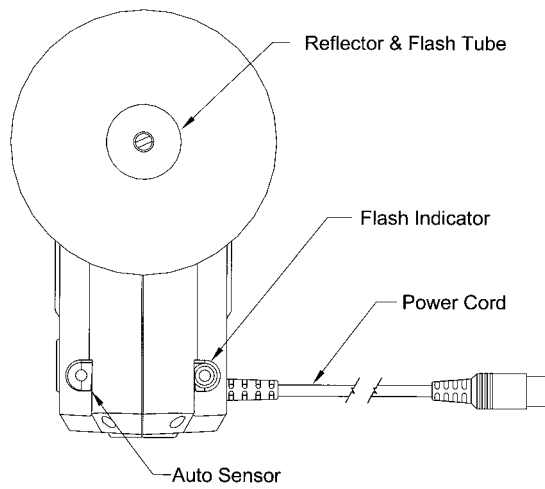
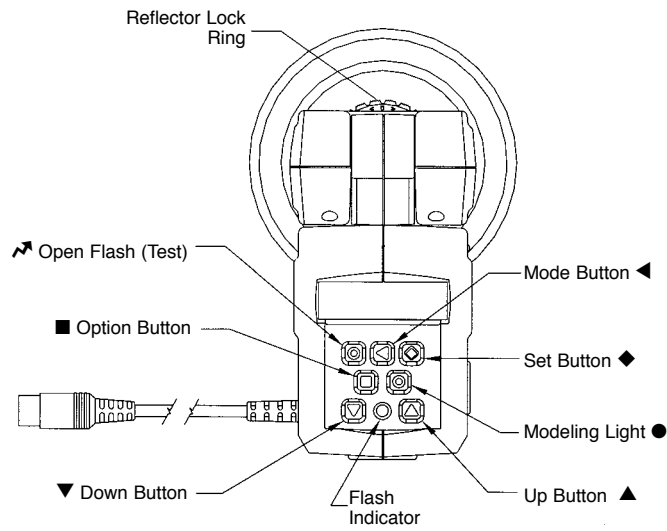

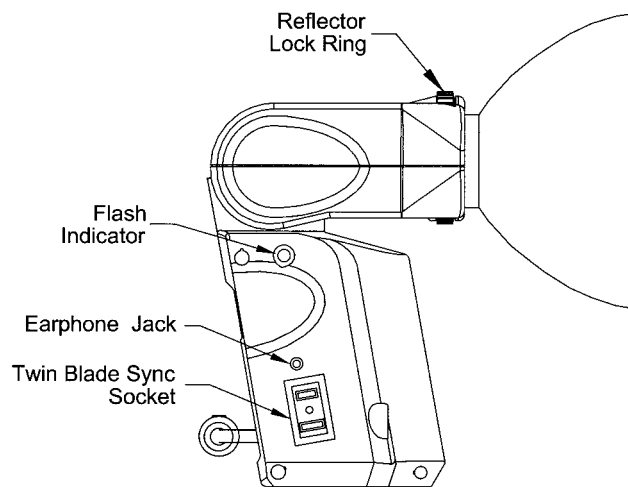
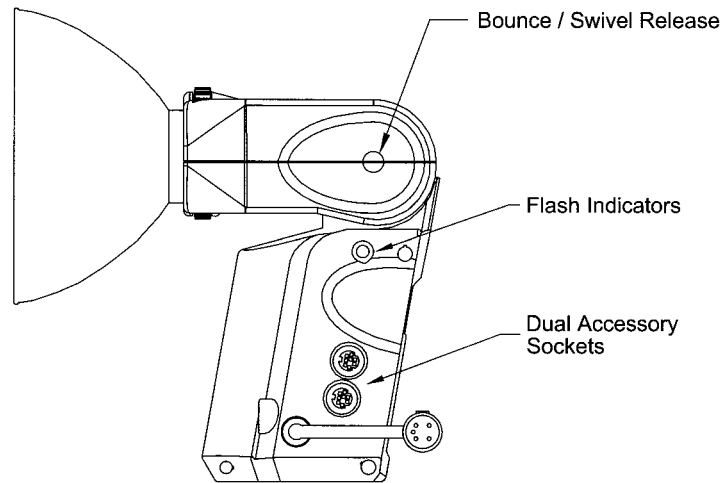

Flash Display Symbols











	Speaker
	Flash indicator LEDs
	On solid - Flash ready Blinking - Flash recycling
	Front curtain sync
	Rear curtain sync
	Reflector in normal
	Bare bulb reflector
	Reflector with diffusing disks, wide angle dome, or soft box
	Telephoto reflector
	Auto sensor limit turned off

TABLE OF CONTENTS

Section	Description
1.0	Introduction
2.0	Warnings
3.0	Advanced Features Summary
4.0	Features available with QTTL (D, Dw, Dw-R series) Adapters
5.0	Getting Started
6.0	Basic Navigation
7.0	Common Features
8.0	Basic Options
9.0	Manual Mode Operation
10.0	Automatic Mode Operation
11.0	TTL and QTTL Mode Operation
12.0	Stroboscopic Mode Operation
13.0	Program Mode Operation
14.0	Wireless Qflash Operation
15.0	Wired Control Mode
16.0	Typical Lighting Situations

1. INTRODUCTION

Qflash "5d-R" series flashes provide professional quality lighting for both digital and film cameras. Quantum's proprietary QTTL® Adapters dedicate Qflash seamlessly to your camera. Many features of Qflash5d-R will enhance your lighting control when used with non-dedicated/manual cameras.

While powerful and extremely versatile, Qflash operation is intuitive and straightforward. Advanced features for most lighting needs are accessible as required.

We highly recommend reading this entire instruction manual. Whether or not you require all of Qflash's capability now, you will want to know it exists when the need arises.

Series Qflash 5d-R adds wireless preflash TTL and wireless remote auto to the Qflash features. These features apply when Qflash 5d-R is used in combination with Dw-R series QTTL Adapters, FreeXWire receivers FW7Q and FW8R, and transmitter FW9T or transceiver FW10w. If you own FW10 transceivers, they can be upgraded to become FW10w.

Qflash 5d-R models used with Quantum's proprietary Dw-R Adapters allow you to create ratios with multiple remote Qflashes in the wireless TTL mode. Older D and Dw series Adapters can be upgraded to become Dw-R adapters.

See www.qtm.com for costs for these upgrades. D, Dw, or Dw-R series QTTL adapters are optional for specific makes and camera models. Please consult your dealer or www.qtm.com for the latest availability.

2. WARNINGS AND CAUTIONS

- **Disconnect external power before changing the flash tube, or connecting or disconnecting to/from cameras, power packs, or any other equipment.**
- **OPERATE ONLY WITH A FLASH TUBE IN THE SOCKET!!**
- **DO NOT TOUCH THE FLASH TUBE SOCKET WITH METAL OBJECTS!!**
- **THIS IS A PROFESSIONAL INSTRUMENT. KEEP AWAY FROM CHILDREN!!**
- **DO NOT ATTEMPT TO OPEN THE FLASH UNIT! DANGEROUS HIGH VOLTAGE INSIDE!!**
- **Repairs can be made only by a qualified Quantum service representative.**

3. ADVANCED FEATURES SUMMARY

The chart below summarizes the advanced features for various Qflash series. A "U" means the Qflash model will have this feature when upgraded to series 5d-R. An "F" means this feature is available in the model shown.

Feature	Qflash Models (T and X types)		
	QF4d	QF5d	QF5d-R
Wireless Control in Nikon/Canon systems with Qnexus	U	U	F
Wireless multiple ratio TTL- with Dw-R Adapters & FreeXWire	U	U	F
Wireless preflash TTL with digital cameras -using Dw/ Dw-R Adapters and FreeXWire	U	F	F
Wireless remote Auto / Auto Fill mode	U	F	F
Zone control of FW7Q from panel of Qflash	U	F	F
Flash ready indication in camera viewfinder	F	F	F
Shutter speed control (camera detects flash and sets shutter)	F	F	F
Rear Curtain Sync	F	F	F
Auto focus assist	F	F	F
Auto Fill ratio	F	F	F

4. FEATURES AVAILABLE WITH QTTL (D, Dw, Dw-R SERIES) ADAPTERS

Quantum's QTTL® adapters provide a dedicated link between Qflash 5d-R series and popular digital and film cameras.

Wireless multiple ratio TTL - with Dw-R series Adapters & FreeXWires, remote Qflashes can be set to ratios of the camera's TTL metering system. For example, an on-camera flash could be set 1.6 stops down, a main flash on the left to +1 stop, and a hairlight to -2 stops from the camera TTL exposure.

Wireless preflash TTL with digital cameras - when using Dw or Dw-R series QTTL Adapters, you can control Qflash exposure wirelessly with your camera's TTL exposure control system.

Rear curtain sync - If supported by your camera, the QTTL adapter can fire Qflash in sync with the rear curtain. Rear curtain sync is selected by a switch located on the back of the adapter.

Auto focus assist - If your camera requires an infrared focus assist, the QTTL adapter will project a beam when the camera focuses.

Flash Sync speed control - If flash readiness is achieved, the camera's automatic system switches the shutter speed to the correct flash sync speed.

Ready light - Flash readiness is established when the "Ready" indicator appears in the Qflash display. If "flash ready" is supported by the camera, then a flash symbol will appear in the viewfinder when Qflash is recycled and ready.

Pre-flash TTL - Cameras that have advanced TTL metering systems require a pre-flash to determine proper exposure. This pre-flash is supported by the QTTL adapters.

QTTL adapters support the features mentioned above **only when the camera connected also supports those features**. Please see the list of adapters available for cameras in the latest Quantum Price List or at www.qtm.com.

5. GETTING STARTED

5.1 Inserting the Flash Tube

Match the red dot on the base of the flash tube with the red dot in the socket of Qflash. Push the flash tube in until it is seated snugly into the socket. **Excessive force is not required.**

Replace the flash tube only with Quantum type QF30 or QF30uv for Qflash model T5d / T5d-R. Qflash model X5d / X5d-R requires QF32 or QF32uv flash tubes. Other flash tubes will not provide proper exposure, may not work at all, or they may damage the Qflash.

5.2 Reflectors and Bare Bulb

Reflectors are secured by the locking ring near the base of the reflector. Rotate the ring in the directions shown in the diagram to loosen or tighten the reflectors.

When inserting a reflector, first slowly rotate it until the notch in the reflector "drops" fully into head of the Qflash. Then tighten the locking ring. If you do not let the reflector drop fully into the Qflash before locking it, the reflector may become loose during use.

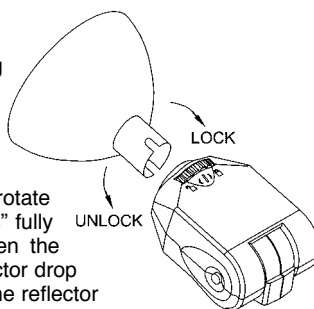

Reflector	Approx. Angle	Guide No. for ISO 200*		
		QFT5d-R	QFX5d-R 200Ws	400Ws
Normal QF60	55°	226ft / 72m	226ft / 72m	320ft / 100m
QF60 w/ flat diffuser	70°	128ft / 40m	128ft / 40m	180ft / 56m
QF67A Dome Diffuser QF68 Soft Box QF69 Mini Soft Box	90°	128ft / 40m	128ft / 40m	180ft / 56m
QF62Bs/g Bare Bulb Reflector	120°	90ft / 28m	90ft / 28m	128ft / 40m
QF63B Tele Reflector	20°	453ft / 143m	453ft / 143m	640ft / 202m

Note to previous Qflash T, T2, X or X2 owners: There is no longer a "Wide" position for the reflectors. The only position is "Normal". For wide angle coverage, use the included flat diffusers, or optional QF67A wide angle or Soft Box QF68 diffusers.

5.3 Bounce and Swivel Head

The head position is locked and can be changed with a single button (see diagram). Press and hold this button, then adjust the head to the desired position. Release the button, and slightly move the head until it "clicks" and locks the head into the vertical and horizontal planes.

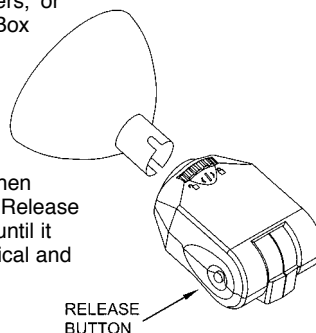

5.4 Bracket Mounting

Qflash mounts with a 1/4-20 standard tripod thread to brackets, light stands, and tripods. Many brackets are made especially for Qflash by popular bracket manufacturers.

Quantum has two optional brackets, models QF70US and QF70E. The instructions below describe mounting to both of these brackets and to other manufacturers brackets, light stands, and tripods.

Two types of 1/4-20 fasteners screw/knob and a friction pad are supplied with Qflash. Place the friction pad between Qflash and the bracket, insert the knob/screw and tighten. (If the mounting surface has a pad, the friction pad is not necessary).

Note: Brackets vary in thickness - always make sure that the mounting knob/screw screws into Qflash at least two complete turns.

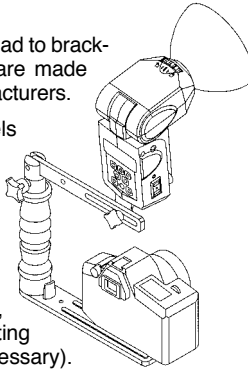

5.5 Connecting Qflash to a Camera

There are two ways to connect a Qflash to a camera- wired and wireless. For wired connection use either of these methods:

- Connect a household two-prong sync cord (supplied) to the sync connector of Qflash.
- Connect a QF series TTL adapter to the camera hot shoe.
- Connect a D, Dw, or Dw-R series QTTL adapter to the camera hot shoe.
- Connect a QF53 Hot Shoe sync to the camera.

For wireless connection

- Use the FreeXWire system. See Section 14 - Wireless Qflash Operation

Consult your dealer or www.qtm.com for the latest TTL and QTTL adapter models.

Note: When using a household type (two-prong) sync cord, if you have difficulty getting the flash to fire, Remove the two-prong plug from the Qflash and reinsert it in the opposite direction. This changes the polarity of the Qflash to match the polarity of the camera.

5.6 Powering Qflash

Before turning on any power to Qflash always make all electrical connections first, both to the camera and to the power pack. Qflash "T" models are powered by any Quantum Turbo Battery including Turbo 2x2, Turbo Compact, Turbo Z, and Turbo SC. Quantum "X" models are powered by the Quantum Qpaq system.

Plug the Qflash power cable into the output connection of the appropriate power pack. Turn on Turbo or Qpaq power. Normally Qflash will be powered up and ready to run.

If a "Check Turbo" or "Check Power" message appears on the Qflash display, turn off the Turbo or Qpaq, wait one second, and turn it on again. If the message appears again, the power pack needs recharging. If a "Reset Flash?" message appears in the Qflash display press any button, except the **Mode** ◀ button, to resume operation.

6. BASIC NAVIGATION

This Section explains how to maneuver your way around the Qflash 5d-R

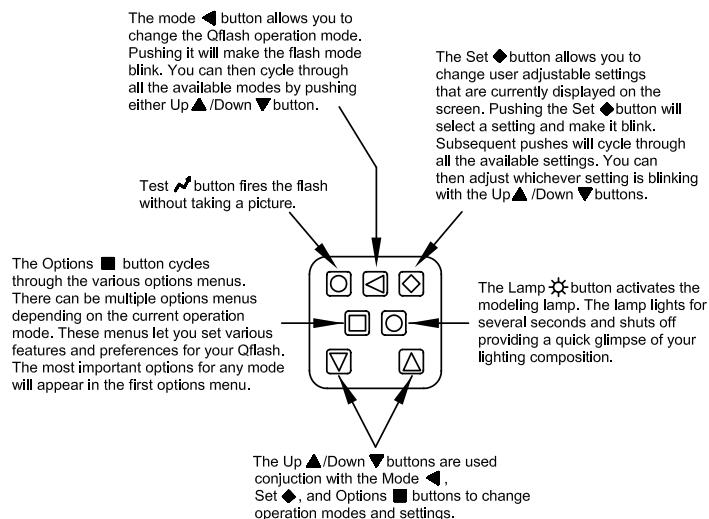

Very Important Tips

For consistent exposures with your digital camera and Qflash.

- Always do a custom white balance before shooting
- When shooting TTL use Aperture or Shutter priority or Manual camera modes
- Set your metering area to center weight, partial metering instead of matrix or multi-spot metering.
- Your Qflash provides 150 watt-seconds of power compared to 50 watt-seconds of a typical shoe mount flash. When shooting 6 ft. (2m) or closer, at ISO 200 or greater, with a wide open F/#, you must always diffuse the light. Otherwise your subject will be over-exposed.

7. COMMON FEATURES

7.1 Flash Ready

The Flash Ready indicator will blink while Qflash is recycling. It will stop blinking once the flash is ready to fire again, and the speaker will beep.

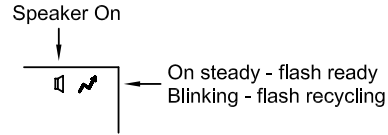

If flash readiness is supported by the camera, then an LED or flash symbol will appear in the viewfinder when the flash is ready. Many cameras will automatically switch the shutter to the camera pre-defined flash sync speed.

7.2 Display, Speaker, and Indicator Lights

Qflash indicates the result of a flash exposure in Automatic and TTL/QTTL modes via the Display, Speaker and Flash Indicator Lights. The signals are shown in the table below:

<u>Flash exposure condition</u>	<u>Display</u>	<u>Speaker/ Earphone</u>	<u>Flash Indicator Lights</u>
Good exposure	OK	one beep	rapid blink
Under/Over	Undr or Over	3"beeps	3 blinks, pause, 3 blinks, pause...
No flash	No Flash	long steady beep	long steady on

7.3 Sync Turn Off

If you are using Qflash as an on camera flash and want to disable the flash for a few shots, you can use the 'sync turn off' feature. To prevent Qflash from firing, press **Mode** ◀ twice. The word 'OFF' will appear in the display. To return to normal operation press any button (except **Test** ↗). Other Qflashes connected to this on-camera flash, whether by cable or wirelessly, will fire (unless they also are turned off).

This feature will only prevent the flash from firing, it will not turn off the Qflash or the Turbo. To completely turn off the Qflash the Turbo must be turned off.

7.4 Rear Curtain Sync

When using a QTTL Adapter, Qflash can fire the flash with the rear curtain (if supported by your camera). Rear curtain sync is selected with the switch located on the back of the QTTL Adapter. Set it to "R" for rear curtain, or "F" for front curtain. For some cameras rear curtain is controlled through a menu on the camera itself. For these cameras leave the switch in the "F" position. Consult your camera's manual.

7.5 Auto Focus Assist

The D/Dw/Dw-R series QTTL Adapters will project a beam whenever the camera is having difficulty focusing due to low light conditions. A local Qflash must be connected for this feature. Turn the auto focus assist switch of the QTTL Adapter to on (☼).

Always turn the auto focus assist switch off (●) under any of the following conditions:

- When no Qflash is connected;
- When using Qflash models, T, T2, X or X2. These models do not support auto focus assist;
- When using a QF50 or QF51 extension cables.

If the auto focus switch is not turned off for the above conditions, proper operation cannot be assured.

8. BASIC OPTIONS

You can cycle through the option menus in this section by pushing the **Option** ■ button. Then select an option to change by pressing the **Set** ◆ button until the option you want to change blinks. Then use the **Up** ▲/**Down** ▼ buttons to make the change.

Option Menu 1:

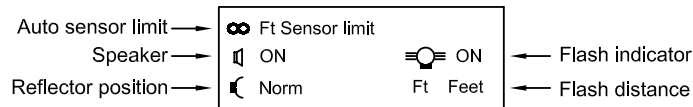

8.1 Flash Sensor Limit for Auto Mode

Flash sensor limit is an option that limits the distance that the sensor “sees” when the Qflash is in **Auto** mode. This option is described in detail in section 10.

Speaker

You may want the speaker off for sensitive shooting, or turn it on for audible confirmation of flash exposure. The earphone signals always sound whether the speaker function is set on or off.

Flash Indicator Lights

The red Flash Indicators on four sides of Qflash give visual indication that a flash fired, whether the exposure was good, over, under, or no flash, indicating that the flash did not fire. You can enable or disable the lights.

Reflector settings

Setting the reflector type is important so that the displayed distance, guide number and *f/#* correspond to the reflector in use. The choices are **NORM** (for the reflector supplied with Qflash), **DIFF** (for diffusers supplied with Qflash, and optional QF67A wide-angle diffuser or softbox QF68), **BBE**

(optional Bare Bulb Enhancers QF62Bs and QF62Bg) and **TELE** (for optional QF63B Tele photo reflector). The reflectors must be repositioned manually.

Notes:

When using QF62B s/g the manual parameters are accurate only for an open area. In medium and small rooms the very widely dispersed light will bounce off nearby walls and increase exposure. A practical solution when using QF62B in small rooms is to meter the light, or use Auto, TTL, or QTTL modes which will provide better exposures and attractive, soft lighting.

When using a Telephoto Reflector QF63B the Auto mode cannot be used because the flash sensor is blocked. Use Manual, TTL, QTTL, Strobe or Linked modes.

Use "B" series reflectors (QF61B, QF62B g/s, QF63B) with Qflash 5d-R. The standard QF60B reflector mounts to Qflash 5d-R as well.

Distance Units

Set your preference for the display of metric (M) or US distance (Ft) units. Guide numbers also change accordingly.

8.2 Option Menu 2:



Exposure Compensation

Quantum calibrates Qflashes to American National Standards Institute (ANSI) standards with laboratory equipment traceable to the National Institute of Standards and Technology (NIST). From time to time, photographers may wish to fine tune Qflash exposures to match their exposure meters, to compensate for variations in cameras or films, to match particular styles, for effects, or for individual taste.

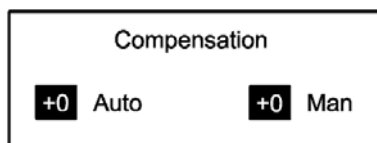
There are two compensations available- one for Manual and one for Auto mode. In QTTL modes Qflash does not control exposure and compensation will not apply. The compensation also does not apply whenever Wireless or Wired appears in the display.



8.2.1 Setting Compensation

Press **Set**  until the compensation you wish to change blinks. Adjust compensation **Up** /**Down**  in 1/3 steps up to +2 or -2 stops. All exposures for that mode will be compensated by the amount selected. You cannot limit compensation settings to individual programs in program mode.

For calibration to a particular light meter you may use the procedures below. It is very important to note the meter measurement type (incident, reflected) used for each procedure!

8.2.2 Manual mode Qflash Compensation

This procedure will calibrate Qflash to an **incident light** flash meter you use and trust. Note that only incident light measurements are reliable for manual exposure settings.

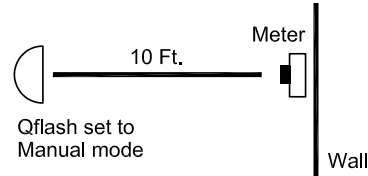

1. Place the Qflash 10 feet from the incident light flash meter **facing** Qflash.
2. The area surrounding the meter and flash should be similar to the shooting environment you usually work in. For example, in a large hall, there will be little light bouncing from walls and ceilings. In a small room, the light meter reading will be increased by whatever bounce occurs from nearby surfaces. These factors will affect calibration and should be considered.
3. Turn Qflash on and change the manual power setting to 1/8.
4. Set the film speed on the flash and the flash meter to the same value.
5. Change the F number on the flash until the distance shown in the display is 10 feet.
6. Fire Qflash. Push the the **Option** ■ button, until the compensation display appears.
7. Use the **Set** ◆ and **Up** ▲/**Down** ▼ buttons to adjust compensation until the f/number in the display matches the f the f/number on the meter. The light output can be increased or decreased by as much as 2 stops in 1/3 steps.

8.2.3 Auto mode Qflash Compensation

This procedure will calibrate Qflash to a **reflected light** flash meter you use and trust. Note that only reflected light measurements are reliable for auto exposure settings.

This is because auto mode flashes read reflected light from the scene and subject. In order to compare those readings to a meter, the meter must also be reading the same reflected light.

The reflected light is affected by the subject and background, and an incident light reading will not typically provide the same reading (unless the subject is an 18% gray card).

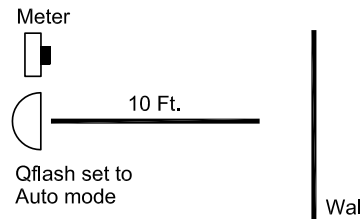

1. Place the Qflash 10 feet from a blank wall. The wall should be larger than the metering area of the meter, and preferably a wall of continuous tone (blank wall).
2. Place flash meter next to Qflash, also facing the blank wall. Be sure to set the flash meter for a **reflected** reading.
3. Turn Qflash on and change the f/ number to F8.0
4. Set the film speed on the flash and the flash meter to the same value.

5. Fire Qflash. Push the the **Option** ■ button, until the compensation display appears.
6. Use the **Set** ◆ and **Up** ▲ button to increase light output (if flash meter reads less than F 8.0), or the **Down** ▼ button to decrease light output (if flash meter reads more than F 8.0). The light output can be increased or decreased by as much as 2 stops in 1/3 steps.

8.3 Option Menu 3

FW7Q Zone Control

This option menu is only available when a FW7Q is attached to the Qflash. With this option menu you can access the zone and the range settings of the FW7Q.

You can enter this menu by pushing the **Option** ■ button until it shows up

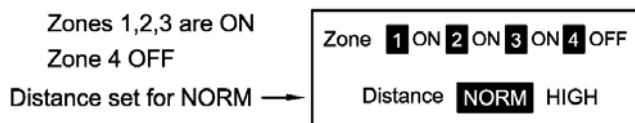

on the Qflash's display. The **Set** ◆ button will cycle through the available settings. Use the **Up** ▲/ **Down** ▼ buttons to make a change.

8.4 Restoring Factory settings

Qflash options and settings are preset at the factory. You can restore the factory settings by the following method:

1. Turn Turbo or Qpaq OFF. Connect Qflash to Turbo or Qpaq.
2. Press and hold any button (except **Test** ⚡).
3. Turn Turbo or Qpaq ON.
4. The Qflash will display a reset message.
5. Press **Mode** ◀ to reset the Qflash and restore the factory settings.

If you push any other button or fail to push the **Mode** ◀ button within 4 seconds, the Factory settings will not be restored.

9. MANUAL MODE OPERATION

The camera exposure may be set to any mode, and Qflash will emit the fixed amount of light shown on its display.

9.1 Manual Mode with sync only connection

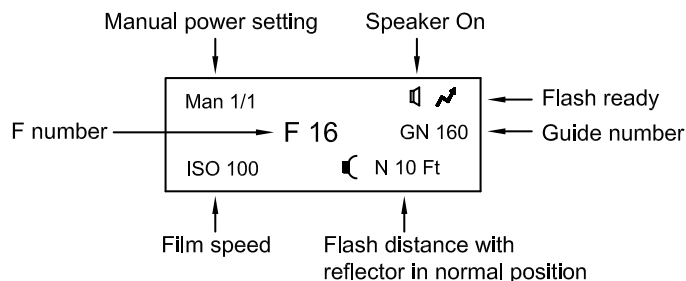

Power, F/number, ISO are all user adjustable. The **Set** ♦ button will cycle through them in that order.

Power settings are adjustable in 1/3 steps from full power to 1/64th power like this: 1/1, 1/1-, 1/2+, 1/2, 1/2- 1/32, 1/32-, 1/64+, 1/64. Using ISO and Aperture settings, Qflash calculates the optimal flash distance. Match these settings to your camera's film speed and aperture.

Flash Compensation setting allows you to fine tune your Qflash in manual mode from +2 to -2 stops in 1/3 step increments.

For model X5d-R only there is an additional Manual setting for 200/400 watt seconds, which can be set in the option menu.

9.2 Manual mode with QTTL adapter connection

With a QTTL adapter the camera controls the f/# and ISO shown on the display - you cannot change it on Qflash. The camera also selects its shutter speed consistent with flash exposure. The camera exposure may be set to manual, aperture or shutter priority.

The power level is set on the Qflash. Qflash will emit the fixed amount of light shown on its display, and the distance shown corresponds to the subject distance for good exposure for the f/# set on the camera.

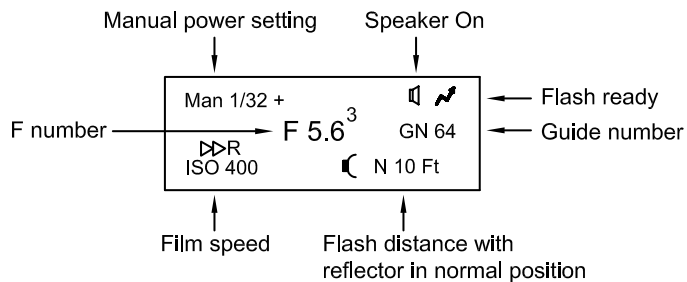

The following QTTL features are available: Front or Rear curtain sync, Auto focus assist, and Ready light.

9.3 Manual shooting made easy

Nothing can beat the combination of a flash meter and a flash set manually. Automatic and TTL are a compromise based on the need for speed. Setting the flash for a manual power setting and taking an incident meter reading takes time and resources the average photographer may not have. So we use automatic flash exposure and know that in some situations the sensor may be fooled.

The Qflash 5d-R allows for easy manual shooting without metering. Below is an example of how this is accomplished.

In this example Qflash will produce an F8.0 at the subject (8 ft), and it will be quickly accomplished without metering.

Start by selecting the F number and Film speed you are using on your camera. If you have connected a QTTL adapter these are already chosen for you. Now adjust the power setting until the Qflash distance shown matches the subject distance as closely as possible.

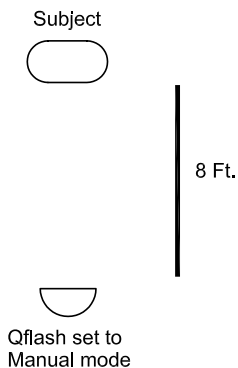

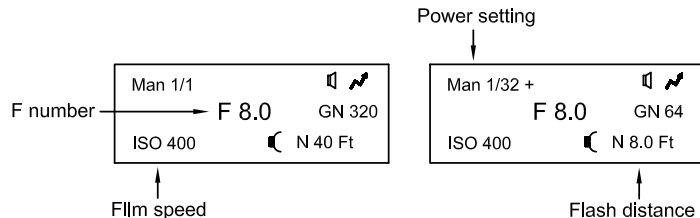

Reminder: If the distance to the subject changes (you move in for a head shot, or move out for a full length) you must change the flash distance readout by changing the power setting.

10. AUTOMATIC MODE OPERATION

The preferred setup for Auto Mode is to connect Qflash to a camera with a QTTL (D, Dw, or Dw-R series) Adapter. Then, the ISO and f/# settings of the camera are set and displayed on the Qflash panel. Qflash will display "Auto Fill" indicating that fill/flash ratio may be set on the QTTL Adapter. The camera may be set to manual, shutter or aperture priority, however light output is controlled by Qflash.

10.1 Automatic Mode with Sync only Connection

Using only a plain sync cord, Qflash displays "Auto" Mode. F/# and ISO are set on the Qflash display manually. Press **Set** \blacklozenge to select f/#, then press the **Up** \blacktriangle /**Down** \blacktriangledown keys to change the setting. Similarly, press **Set** \blacklozenge twice to select ISO and change it.

Flash distance displays the working distance between your Qflash and Subject based on the current settings. Moving outside this range may result in an Under or Overexposed picture.

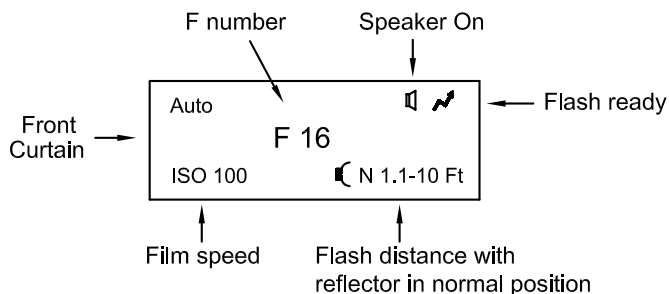

10.2 Auto mode exposure indications

There are three types of exposure indications. The display will blink either OK, Over, or Undr. The display will also indicate how much over or under the last exposure was, from +3 stops to -3 stops. If an arrow appears then the exposure error is more than 3 stops (for example -3 →).

Over exposed by 1 and 1/3 stops

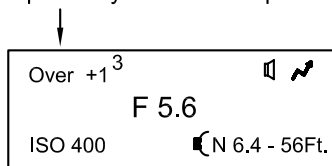

If activated in Options (Section 8.2) the Speaker will sound after a flash. The audible signal is one "beep" for "OK and ready", and three "beeps" for "Undr" or "Over".

10.3 Auto Fill (Auto mode with QTTL adapter)

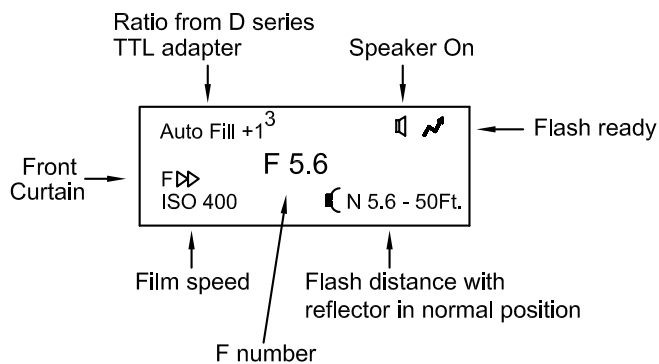

Auto Fill is useful when you prefer to control exposure with the Qflash sensor, instead of a camera's own TTL or pre-flash metering. Many photographers find that Auto Fill mode provides more consistent exposures for digital cameras.

Fill flash ratio may be set using the "Fill" dial on the QTTL adapter. Choose any setting from -3 stops below to +2 stops above the camera's aperture, in 1/3 stop increments. As the aperture of the camera changes Qflash will adjust it's output to keep the ratio that has been selected.

Error messages will appear if you choose a fill ratio which is out of range of the flash. The error indications are:

“OUT OF RANGE - DECREASE FILL OR F#”

For example, the camera is set to F16 and QTTL fill flash is set to +2 stops. Either decrease the f/# on the camera or decrease the fill flash ratio on the QTTL adapter.

“OUT OF RANGE - INCREASE FILL OR F#”

For example, the camera is set to F2.8 and QTTL fill flash is set to -3 stops. Increase the f/# on the camera or increase the fill flash ratio on the QTTL adapter.

Once the adjustment is made and Qflash returns to an acceptable range, the display will revert to the usual Auto Fill information.

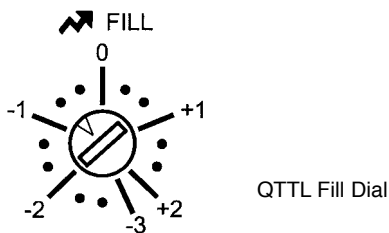

10.4 Auto Sensor Limit

Setting Qflash to Auto exposure makes picture taking fast and easy. However, an automatic flash has a flaw: the sensor on the flash expects the subject to be wide, flat, and fill the view of the sensor. A person standing against a wall fits this description; people in a catering hall or in a park at night do not. When the background is located far behind the subject, the automatic flash struggles to produce even lighting. The result is often an over exposed subject, sometimes by as much as two stops. When a photo lab develops film with a greatly over exposed subject, it will 'print down' to bring the flesh tones back into range. Or, time will be spent adjusting a digital image, with the resultant loss of detail and image quality.

To solve this problem use the Flash sensor limit.

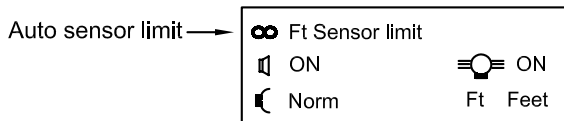

10.5 Setting the Sensor Limit:

Press **Option** ■ button to bring up this menu. Push **Set** ◆ once. The sensor limit will blink. Use **Up** ▲/**Down** ▼ buttons to change the sensor limit. The available limits are:

- ∞ - No limit placed on sensor distance
- 20ft / 6m, 15ft / 4m, 10ft / 3m, 5ft / 2m,

When the Flash Sensor Limit is set to ∞ the flash will produce the desired f/# for a subject within the flash's minimum and maximum flash distance.

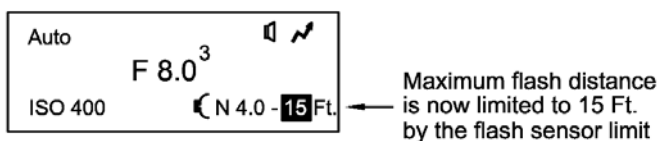
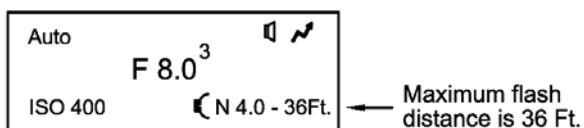

With Auto Sensor Limit turned on, a 'Limit' indicator is activated. After a flash, if the subject's distance exceeds the sensor limit currently set (5, 10, 15 or 20ft. / 2, 3, 4, 6m) the word 'Limit' will appear in the display. Three beeps and/or 3 blink warning may also occur (if those features are set in Options). If the subject is within the current sensor limit normal exposure indicators (OK, Undr, Over) will apply.

10.6 Quick turn ON / OFF of Sensor Limit

There are times you may want to quickly change from a Sensor Limit distance, to no sensor limit [∞]. For example, at a wedding reception you may shoot close up from 5' with no background, and next shoot a group shot from 25'.

To set or cancel a sensor limit quickly: Press the **Option** ■ button until you bring up the menu with the Sensor limit setting. Then, without pressing the **Set** ◆ button, use the **Up** ▲/**Down** ▼ buttons to toggle between maximum sensor limit [∞] and the last sensor limit set (in the procedure above).

You can also use Program (Section 13) to preset the sensor limits you want. Then, just toggle between them using the **Up** ▲/**Down** ▼ buttons.

10.7 Using the Sensor Limit

The flash Sensor Limit function essentially cuts down on the distance that Qflash attempts to illuminate. See the examples shown below.

Open field

The subject is located 15 feet from the camera. The background is an open field in a park. By setting the Sensor Limit to 15 feet, the flash will read only the light from subjects within 15 feet, ignoring anything further.

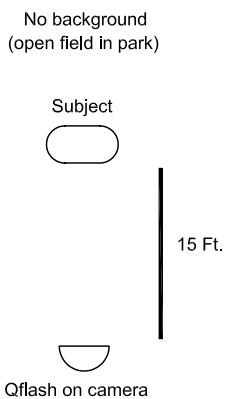

Two subjects separated by a gap

Sometimes two subjects are separated by a gap. When this occurs the sensor is 'looking' between the two subjects and may miss them. The Sensor Limit will correct for this by reading only the light from objects within the limit set, in this case, 15 feet. The light from objects further away will be ignored.

With the Sensor Limit it is no longer necessary for the subject to be centered in the frame. As long as the subject is within the Sensor Limit it will be lit properly.

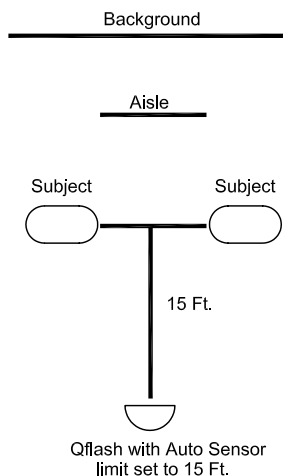

11. TTL and QTTL MODE OPERATION

TTL Mode

TTL mode may be used when the camera exposure is set to manual, aperture or shutter priority, or program mode, and Qflash is connected to the camera with a compatible QF series Adapter. The camera will determine flash exposure. The listing for compatible QF series TTL adapters is available from your dealer, or at www.qtm.com. QF series TTL adapters are generally not compatible with digital cameras.



The exposure indications for TTL mode are similar to those of Auto mode with one exception. The amount of under or over exposure will not be shown in the display.

QTTL mode

When using a D, Dw, or Dw-R series QTTL adapter, "TTL" is replaced by "QTTL" on the Qflash display. QTTL mode has all the features of the Auto Fill mode including adjustment of fill ratio. The difference is that QTTL mode lets the camera, not Qflash, control exposure.

Set your camera to manual, aperture or shutter priority, or program mode for QTTL dedication to Qflash 5d-R.

Some cameras allow compensation (+/-) for flash/fill ratio. Qflash 5d-R flash/fill can also be set on the QTTL adapter using the "Fill" dial. Choose any setting from -3 stops below to +2 stops above the camera's aperture, in 1/3 stop increments. When desiring flash/fill ratio use **either** the camera setting or the QTTL adapter setting, **but not both**.

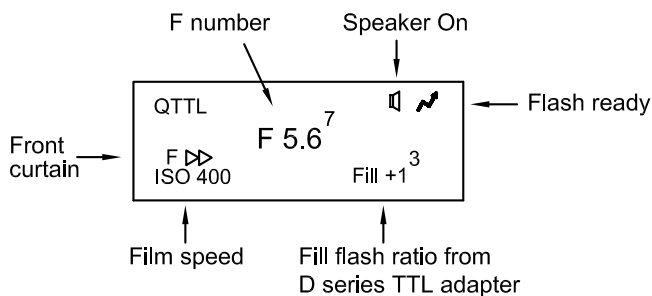

12. STROBOSCOPIC MODE OPERATION

Press the **Set** \blacklozenge to cycle through Frequency, Number of Flashes, and Strobe Power, in that order.

Connect a sync cord or any Quantum QF, D, Dw, or Dw-R series Adapter to the camera. After the flash has finished firing a confirmation message will be displayed. The flash will display the actual number of flashes fired. Strobe is a manual exposure mode. Over and Under exposures are not indicated.

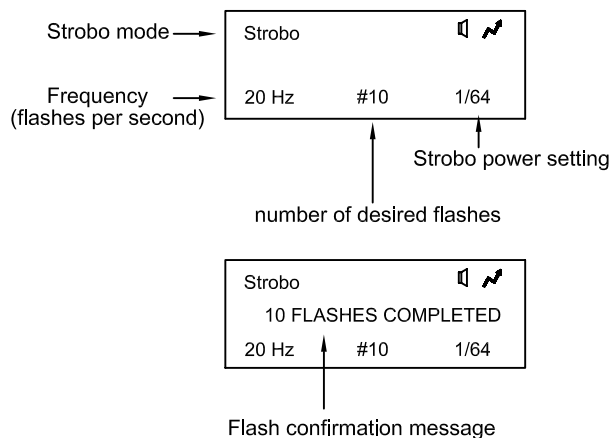

13. PROGRAM MODE OPERATION

The Program mode allows you to store your favorite settings and set-ups and then quickly recall them just by pressing the **Up** \blacktriangle /**Down** \blacktriangledown buttons. Program up to 8 Qflash set-ups of Manual, Auto, or TTL operation, including settings for all parameters.

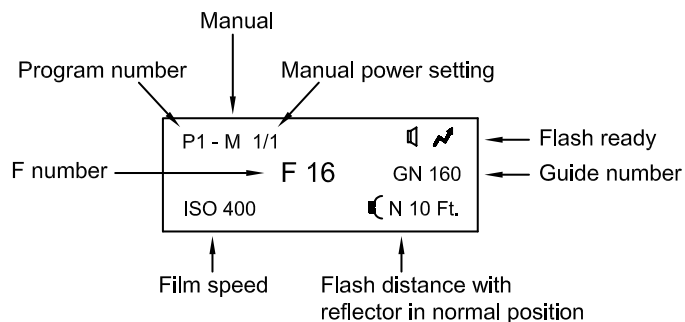

Your Qflash is factory preset with several Programs (which you are free to change). To view them, press **Mode** ◀, then **Up ▲/Down ▼** until you see the Program mode displayed, like above. After the "P" stops blinking, press the **Up ▲/Down ▼** buttons to switch to the next higher, or lower program number. (Programs which have not been preset are considered "clear" and will be skipped).

How to set up or change a Program

While in the Program mode, press the **Set** ◆ button. The program number will blink, and the **Up ▲/Down ▼** buttons will select the program number you wish to set or change. All program numbers will be displayed this way, even those that are "clear".

Press **Set** ◆ again (or press it twice if the Program number stopped blinking). The mode (Manual, Auto, TTL, etc.) will be blinking. **Up ▲/Down ▼** to select your flash mode for this program.

Once your flash mode is selected keep pressing **Set** ◆ to choose parameters to program. To change any settings use the same procedures used for Manual, Auto, TTL, or Wireless/Wired modes.

There are times when you will want to "clear" a Program from memory. Clearing unwanted programs allows for quicker switching between stored programs during actual shoots. For example, if you need just 3 Programs for a job, and you clear out the other 5 Program numbers, you will cycle through just the 3 Programs you want for a shoot, using the **Up ▲/Down ▼** buttons.

To clear out a Program

Start in the Program number you wish to clear. Press **Set** ◆ until the 'mode' blinks in the display. Press **Up ▲/Down ▼** until the word CLEAR appears. After several seconds the display will stop blinking and the program will be cleared from memory. Note: You can never clear out Program 1.

14. WIRELESS QFLASH OPERATION WITH FreeXWire

Qflash 5d-R are capable of wireless operation using one or more units connected to FreeXWire radios. Depending upon your needs, select one of the operating modes below. There are also additional combinations of modes that are possible for Local and Remote wireless Qflash operation which are detailed in the chart of Section 14.5

Important: Note the series of FreeXWires and QTTL Adapters indicated in each setup to be assured of proper operation.

14.1 QTTLw - Wireless TTL mode

QTTLw mode gives exposure control of all Qflashes to your camera's pre-flash evaluative TTL metering system. Both Local (on-camera) and Remote Qflashes will produce the same exposure. The Fill ratio can be adjusted on the QTTL adapter (or on the camera, if available). However, use only one Fill compensation at a time.

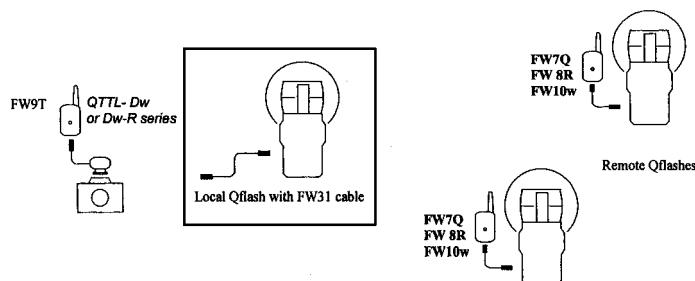

Set the camera modes: Choose manual, aperture priority, or shutter priority on your camera. Program mode may be selected, although the camera will make decisions that reduce your control of lighting.

14.1.1 A Local Qflash is optional.

If a local Qflash is attached to the camera, Press **Mode** ◀, the **Up ▲/Down ▼** until "QTTL" or "QTTLw" appears on the display.

Note: "QTTLw" will appear after the QTTL adapter has established communication with the camera. This occurs when the camera shutter is pressed 1/2 way.

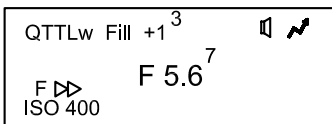

14.1.2 Set up the Remote Qflash(s)

Connect a FreeXWire receiver to the remote Qflash(s). FreeXWire model FW7Q connects directly to Qflash; models FW8R or FW10w require an FW31 cable for connection.

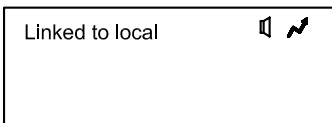

Press **Mode** ◀ on the Remote Qflash, then press the **Up ▲/Down ▼** buttons until the display shows "Linked to Local".

14.2 QTTLwR - Wireless Multiple Flash Ratio TTL mode

QTTLwR mode provides the photographer with the ability to set three zones of flash exposure, each with different amounts of exposure offset from the camera's TTL system. The three available flash zones are : Local, Group R1, Group R2. Any number of Qflashes can be employed in each of the 3 groups. For example, an on-camera flash could be set 1.3 stops down (Local), two main flashes on the left to +1 stop (Group R1), and a hairlight to -2 stops from the camera TTL exposure (Group R2). The actual settings could be whatever you wish within +/- 3 stops.

Set the camera modes: Choose manual, aperture priority, or shutter priority on your camera. Program mode may be selected, although the camera will make decisions that reduce your control.

14.2.1 Always set up the Remote Qflash(s) first

Connect a FreeXWire receiver to the remote Qflash(s). FreeXWire model FW7Q connects directly to Qflash; models FW8R or FW10w require an FW31 cable for connection.

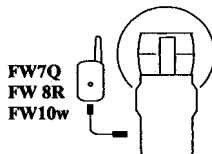

To set a Remote flash to the Local group: Press **Mode** ◀, then **Up ▲/Down ▼** until the display shows **“Linked to Local”**. This Remote Qflash exposure will be the same as the Local, on-camera Qflash.

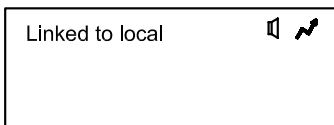

To set a Remote flash to the Group R1 or Group R2: Press **Mode** ◀, then **Up ▲/Down ▼** until the display shows **“Wireless Group R1”** or **“Wireless Group R2”**.

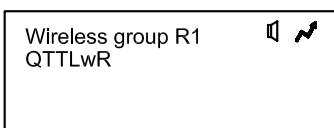

“QTTLwR” will appear on the Remote display only when the Local Qflash is set up. If QTTLwR does not appear press **Mode** ◀ on the Local Qflash 3 times to re-sync the Local Qflash with the Remotes. Also check that the FreeXWire units are connected properly and turned on.

Continue setting all the Remote Qflashes to one of the three Groups. There is no limit to the number of Qflashes in each Group.

14.2.2 A Local, on-camera flash is required

Press **Mode** ◀, then **Up ▲/Down ▼** until **“QTTLwR”** appears in the display. You have the ability to turn Remote flash Group R1 or R2, ON / OFF, and the ability to set offset ratios for these groups. **Note:** **“QTTLwR”** will appear after the QTTL adapter has established communication with the camera. This occurs when the camera shutter is pressed 1/2 way.

Press the **Set** ♦ button until ON/OFF next to flash Group R1, or R2, blinks. Use the **Up ▲/Down ▼** buttons to turn the flash Groups ON or OFF. Next, press the **Set** ♦ button until the offset amount blinks (0, -1, -13, etc.). Use the **Up ▲/Down ▼** buttons to select the **desired setting**.

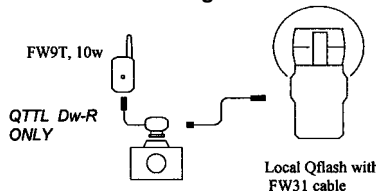
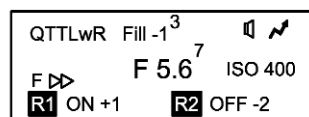

The Local Group flash ratio can be set with the Fill dial on the QTTL Adapter. Use only series DwR QTTL Adapters. The amount of Fill offset shows on the Local Qflash display.

14.3 Wireless Auto Fill

Wireless Auto Fill mode has several useful features. It can add light ratio capability to non-TTL cameras. With digital cameras Auto Fill mode can decrease the delay between shutter release and image capture, compared to the camera system's TTL control. And, Auto Fill with Qflash sensor control lets the photographer fine tune flash exposure for her/his particular needs without being locked into camera TTL exposure.

Set the camera modes: Manual, aperture priority, or shutter priority. Program mode may be selected, although the camera will make decisions that reduce your control of the shots.

14.3.1 A local, on-camera flash is optional.

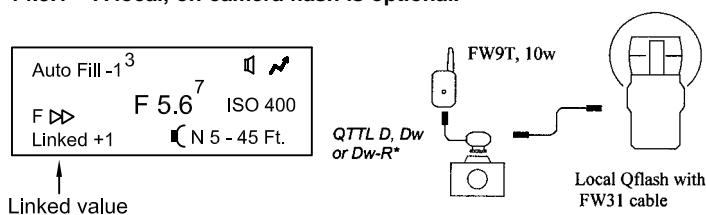

To change the linked value Press the **Set** \blacklozenge button once. Use the **Up** \blacktriangle /**Down** \blacktriangledown buttons to select the desired option. To change the Fill value use the Fill dial located on top of the QTTL adapter.

14.3.2 Set up the Mode of the Remote Qflash(s)

Connect a FreeXWire receiver to the remote Qflash(s). FreeXWire model FW7Q connects directly to Qflash; models FW8R or FW10w require an FW31 cable for connection.

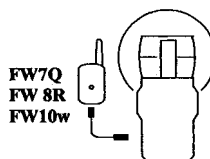

To set a Remote flash to the Local group: Press **Mode** \blacktriangleleft , then **Linked to Local**". This Remote Qflash exposure will be the same as the Local, on-camera Qflash.

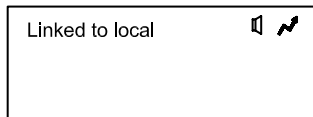

If you are not using a Local on-camera Qflash: Press **Mode** \blacktriangleleft , then **Up** \blacktriangle /**Down** \blacktriangledown until the display shows **Wireless Auto Fill**".

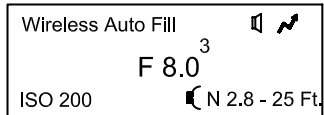

14.4 Wireless Control Mode

Wireless Control mode can achieve the most control over wireless Remote Qflashes. From the camera position you can change the modes, settings, as well as the fill ratios, of Wireless Groups R1 and R2. Wireless Control mode has the disadvantage, however, of being slower to react than QTTLwR mode. This is because much more information has to be transmitted to the Remote Qflashes.

Use Wireless Control mode for maximum control over Remote Qflashes. Select QTTLwR for faster reactions to changes in lighting ratios only.

14.4.1 A Local Qflash is required.

Press the **Mode** ◀ button on the Local Qflash and use the **Up ▲/Down ▼** button to select "Wireless Control." The display will show the data for Control (C) and Group R1 and Group R2.

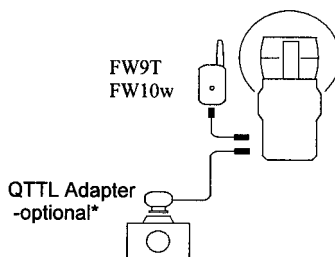

	Wireless control	🔊 📶
Data for Control group (this flash) →	C Man 1/8+ ISO400	
Data for Group R1 flashes →	R1 Auto F5.6 ³	
Data for Group R2 flashes →	R2 Man 1/32+	

Next, from the Local Qflash panel, select the settings for the Remote Qflashes.

- Press **Set** ◆ until either "C", "R1" or "R2" blinks in the display. If necessary, press Up _ or Down _ until "R1" blinks to set the parameters for Group R1, or until "R2" blinks for Group R2.
- Press **Set** ◆ again and the Mode of R1 or R2 will blink. Use the **Up ▲/Down ▼** buttons to select the Mode of the Remote Qflash.
- Press **Set** ◆ again to set the parameters of the Mode selected.
- Press **Set** ◆ again and the word SEND will appear next to the data for R1 or R2. The Control Qflash is now sending the data to the Remote Qflash.

* A QTTL Adapter is not required. If one is used it provides all Qflashes with ISO and F# settings from the camera. Set a fill/flash ratio (for the Control Group only) with the "Fill" dial on the Adapter. Fill ratio applies only in TTL and Auto modes.

14.4.2 Set up the Remote Qflash Groups

Any number of Remote Qflashes may be used. Set each the Mode of each Remote to either Wireless Group R1 or R2, or Linked to Local, using the **Mode** ◀ and **Up** ▲/**Down** ▼ controls on each Remote Qflash.

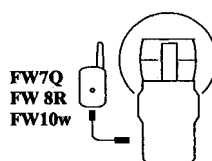
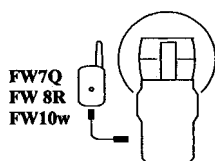
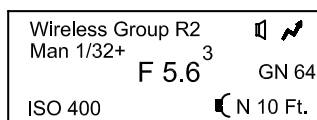
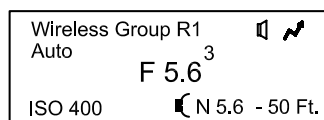

The displays on the Remote Qflashes will update when the word SEND appears on the Local Qflash.

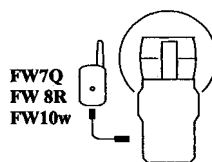
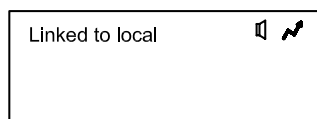

14.4.3 Wireless Control Mode – Important Notes

- Qflash cannot fire while sending data to wireless Remotes, or when the display is blinking. To speed up data transmission, press **Set** ◆ on the Control Qflash until SEND appears in the display to make Qflashes ready.
- When using a QTTL adapter, the camera settings for f/# and ISO will appear on the Control Qflash display. Generally, to update the camera settings, press the camera shutter 1/2 way (to wake up the camera or metering function). The Qflash display will then update to the current camera settings. (On some cameras updating takes place automatically).

14.5 Available Modes and Features of Qflash Wireless Operation

In addition to the setups described in Section 14.1, 14.2 and 14.3, other combination of modes are possible for Local and Remote Qflashes. In the table below, pay particular attention to the models of FreeXWires and QTTL adapters required to achieve the results in the chart. We recommend some testing when using one of the combinations of operating modes before shooting an assignment.

		Available Modes and Features of Qflash Wireless Operation					
		Modes set on Remote Qflashes					
Modes set on Local Qflash	FreeXWires & TTL adapters	Man	Auto	Linked to Local	Auto Fill	Wireless Group R1	Wireless Group R2
Man	FW 9T, 10, or 10w D, Dw or Dwr QTTL adapter	FW 7Q, 8R, 10, 10w	FW 7Q, 8R, 10, 10w	FW 7Q, 8R, 10, 10w	Flash receives F# / ISO / QTTL fill switch info. However, output controlled by its own sensor	FW 7Q, 8R, 10w	FW 7Q, 8R, 10w
Auto	No adapter required			Exposure linked to Local Qflash	Not recommended		
Auto Fill	D, Dw or Dwr QTTL adapter				Flash receives F# / ISO / QTTL fill switch info. However, output controlled by its own sensor		
TTL	FW 9T, 10, or 10w QF series adapter	Remote Qflash exposure controlled by its own Manual settings	Remote Qflash exposure controlled by its own Auto settings and sensor	Not recommended	Not recommended		Qflash mode switches to "Linked to Local" [Note 2]
QTTL	FW 9T, 10, or 10w D series QTTL adapter						
QTTLw	FW 9T or 10w Dw or Dwr QTTL adapter						
QTTLwR	FW 9T or 10w Dwr series QTTL adapter						
Wireless Control	FW 9T, 10, or 10w Dw or Dwr QTTL adapter			Exposure linked to Local Qflash	Flash receives F# / ISO / QTTL fill switch info. However, output controlled by its own sensor		Qflash mode switches to "Linked to Local" [Note 2] Qflash modes switches to "QTTLwR". TTL ratios can be set separately for Group R1, R2. For local Group, use "Linked to Local" mode. Local Qflash controls the modes and settings for Group R1 and R2 Remote Qflashes.
No Local Qflash	FW 9T D, Dw or Dwr QTTL adapter			Exposure linked to camera setting			Not recommended

Notes: 1. Some Local Qflash modes [inside the heavy borders] may not appear on the display depending upon the accessories attached
 2. Wireless Group R1/R2 is intended to work with the Local Qflash in Wireless Control mode.
 However, for other Local Qflash mode settings, the Remote Qflashes will automatically switch to "Linked to Local" or "QTTLwR", as indicated.

14.6 SYNC only setup

By employing this type of setup each Qflash operates independently of the others. This is the simplest and most straightforward way of using multiple, wireless Qflashes.

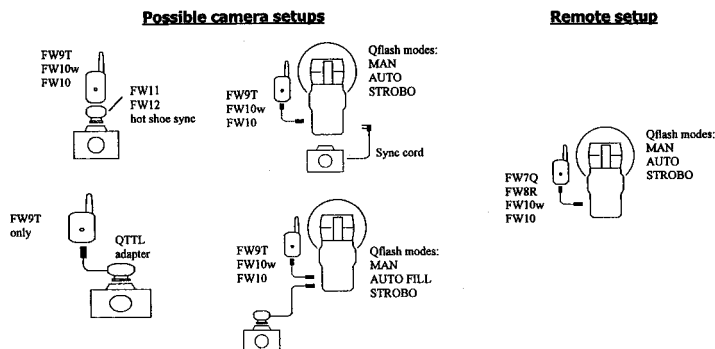

For independent Qflash operation the Qflashes must be in Manual, Auto (Auto Fill), or Strobe. If any one of the Qflashes is in TTL, QTTL, or Wireless, the Qflashes will no longer behave independently.

Example of independent Qflash operation

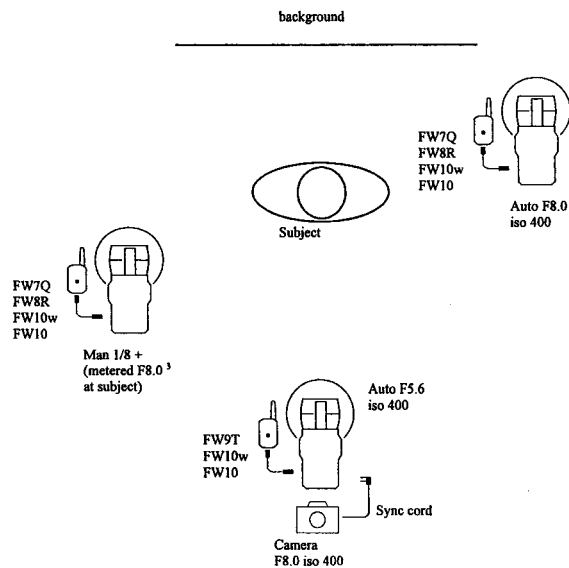

15. WIRED CONTROL MODE

Qflash's Wired Control Mode is a versatile tool for precise lighting control. One Qflash is designated as the "Control", and from its panel the photographer can change the modes or settings on one or two "Remote" Qflashes.

The physical setup for Control Mode is shown below. The camera adapter must be a QTTL series D, Dw, or Dw-R series:

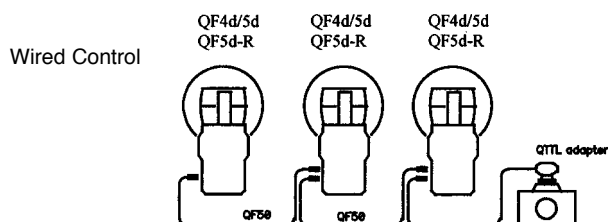

The basic steps for Wired Control Mode setup are:

- Set the on-camera flash to Wired Control. Usually this is the one at the camera. Connect a QTTL Adapter (D, Dw, or Dw-R series).
- Using the Control Qflash panel, select the operating Mode and settings for Control, Remote 1 and/or 2.

15.1 Set up the Control Unit

The number of Qflashes can be 2 or 3. Turn on all Qflashes. The Qflash displays will prompt you to select the Control flash for the "Wired Control" setup. Press the **Mode** button on the Qflash that you want to be the Control Qflash (usually the one at the camera).

The display will change to "Wired Control", and show the data for Remote 1 (R1) and Remote 2 (R2).

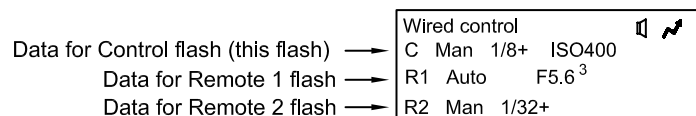
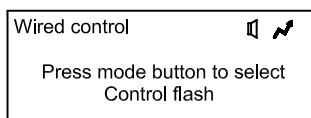

The displays of the two Remote Qflashes will automatically change to R1 and R2.



15.2 Select the Mode and settings for all flashes

Always select the settings you desire for the Control Qflash first. Those settings determine the choices you have for the Remotes.

- Press **Set** until “C” is blinking. (If “R1” or “R2” is blinking instead, press the **Up** /**Down** buttons until “C” blinks).
- Press **Set** again. The mode of the Control flash will blink. Use the **Up** /**Down** buttons to select the mode. The choices are Man, Auto, QTTL and OFF* (see 15.3 – Wireless Setup - Important Notes)
- Press **Set** again to set the parameters for the mode selected. For example, power (1/64 to 1/1) for Man, F# for Auto, etc. There are no settings for TTL or OFF modes.
- Set the fill/flash ratio. To change the ratio, turn the “Fill” dial on the QTTL adapter.

Next, from the Control Qflash panel, select the settings for the Remote Qflash(s):

- Press **Set** until either “C”, “R1” or “R2” blinks in the display. If necessary, press **Up** /**Down** until “R1” blinks to set the parameters for Remote 1, or until “R2” blinks for Remote 2.
- Press **Set** again and the Mode of R1 or R2 will blink. Use the **Up** /**Down** buttons to select the Mode of the Remote Qflash.
- Press **Set** again to set the parameters of the Mode selected.

15.3 Selecting a different flash as the control flash

To select a different flash as the control, press the **Mode** button on the Control Qflash and use the **Up** /**Down** button. The Qflash displays will prompt you to select the Control flash for the “Wired Control” setup. Press the **Mode** button on the Qflash that you want to be the Control Qflash.

15.4 Changing Remote 1 to Remote 2 or Remote 2 to Remote 1

Press the **Mode** button on the Remote Qflash and use the **Up** /**Down** button to change from Remote 1 to Remote 2.

Note : If there is already a Remote 2 Qflash connected, it will automatically change to Remote 1

16. TYPICAL LIGHTING SITUATIONS

This section covers some typical lighting situations that photographers find themselves in. Here is how Qflash can help.

16.1 Portrait

Setting up a 3:1 portrait ratio (or any other ratio) has always been time consuming. It is usually accomplished with three flashes: Main, Fill, Background set to manual. Each flash needs to be adjusted and metered separately. If the Main is in an umbrella or soft box this becomes even more time consuming.

The Qflash 'Wireless Control' mode (with a FreeXWire) or 'Wired Control' mode (with a QF50 cable) provides a method for setting up portrait lighting which takes only a few moments. See Section 15 for details of the Control Modes.

Set the Qflashes as shown in the diagram to the right. Place the camera at the Fill Qflash position. The Main Qflash can be placed in an umbrella or soft box.

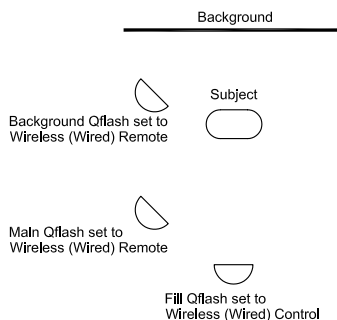

Once the Qflashes are set up, make the following settings to the Control Qflash:

Set Main Qflash to one stop above Fill (which equals your lens)

Set F number of Fill Qflash to one stop less than your lens

Wireless control			
C	Auto	F5.6	ISO400
R1	Linked	+1	
R2	Auto	F5.6	

You can make the background lighter or darker by adjusting the F number

Now the system is set up for perfect portrait lighting, with no metering needed. The on-camera Qflash (Control) which is producing a flat light will shut off one stop below the lens setting (Fill). Remote 1 Qflash will produce a light from the left (loop lighting) that is equal to the lens setting (Main). This will achieve the portrait 3:1 ratio. The ratio can be adjusted by changing the F number of the Control Qflash and the linked ratio.

For a ratio of 5:1 set the F number of the Control Qflash to 2 stops below the lens setting, and set the Linked ratio to +2.

16.2 Wireless lighting ratios made easy

When using multiple lights to light a subject it's very easy to set up a lighting ratio between the Main and Fill lights. The ratio can be set from -3 stops to +3 stops.

Equipment needed:

- One Qflash 5d-R
- One Qflash (any version) located to the right of the subject
- Two FreeXWires
- Two QF30 cables
- Two Quantum Turbo batteries

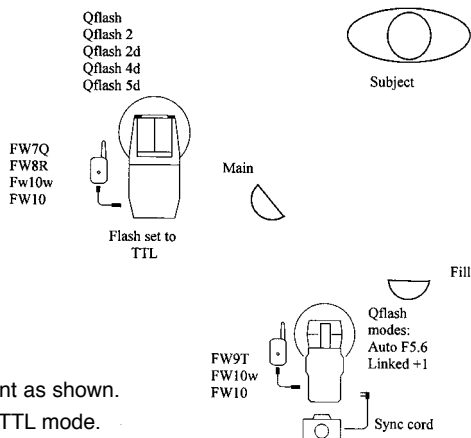

Set up:

- Connect the equipment as shown.
- Set the Main flash to TTL mode.
- Set the Fill flash, located at the camera position to Auto mode. Select an F number that is less than the F number set on the camera. Typically it is set to one stop under the camera's aperture, but can be as low as 2-1/2 stops under.
- Next Adjust the Linked ratio for the difference between Fill flash and the camera's aperture.

Example. If the camera is set for F8.0, and the Fill is set for F5.6, the Linked ratio needs to be set to +1 (the camera is one stop higher than the Fill)

16.3 Lighting ratios using a control cable

This set up is similar to the wireless one above, only Qflashes are connected with QF50 cables instead of FreeXWires.

Equipment needed:

- One Qflash 5d-R located at camera position
- One Qflash / 2/ 2d/4d/5d located to the right of the subject
- One QF50 control cable
- Two Quantum Turbo batteries

Set up: Same set up as above.

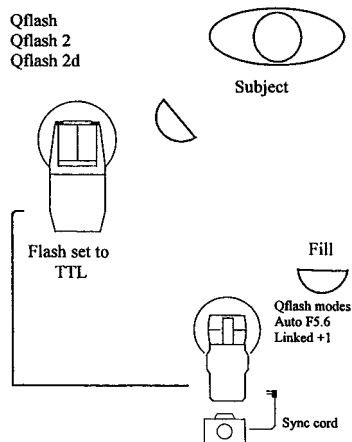

11. CUSTOMER SERVICE

Having any trouble in using your Quantum product? We are here to help. Mail, call, fax, or email our Service Department:

Service Department
Quantum Instruments
10 Commerce Drive
Hauppauge, NY 11788

Tel: (631) 656-7400 Fax: (631) 656-7410
Website: www.qtm.com

Troubleshooting tips are available at www.qtm.com, Support, Customer Support, FAQ. If you suspect a malfunction or require adjustment, return the unit to us with an accurate description of the problem. Please be sure your problem is not caused by improper operating procedure or malfunctions in your other equipment. Send all equipment carefully packaged and insured to our address above.

An estimate of repair cost on out-of-warranty merchandise may be forwarded if you desire. This will require that we contact you for approval before proceeding and will delay return of your equipment. For fastest repair time, you may pre-approve repairs up to a limit of \$85 with your credit card. We will bill you only for actual costs up to that limit. If repair costs exceed your pre-approval, we will contact you.

Paying by check will delay the repair until the check clears (up to 15 days). Payment by money order is acceptable.

Normal repair time is 10-15 days. For expedited service, contact our Service Department.

Summary:

- Ship via UPS, Parcel Post, or other carrier, insured.
- Give a clear, detailed description of the problem.
- Give your mailing address and daytime phone number, fax #, and/or email.
- For warranty repairs include a copy of the receipt.

In addition, for out-of-warranty repairs with pre-approval:

- Provide your Visa, MasterCharge, or American Express card # and expiration date.
- Give us authority to charge repair costs up to \$85.00.
- Provide your billing address.

Note: Please do not e-mail your credit card information

LIMITED WARRANTY

Quantum products have a 1 year limited warranty. Please refer to the Limited Warranty card for complete details, conditions, and terms.

Qflash ACCESSORIES

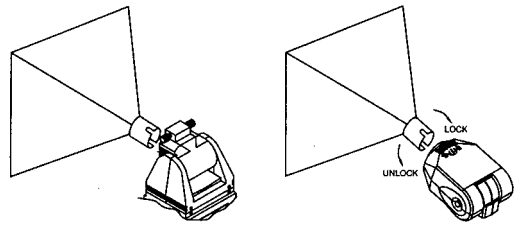
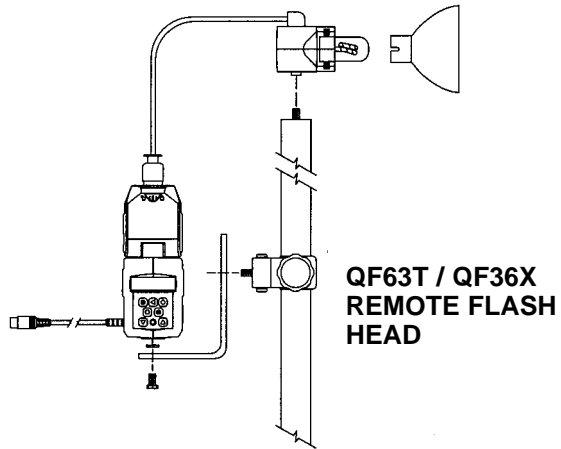

QF68 SOFTBOX

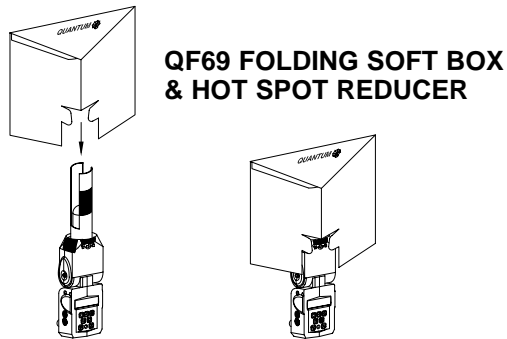

OTHER QUANTUM PRODUCTS

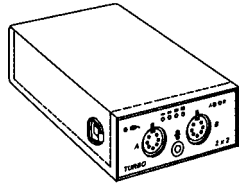

TURBO 2X2

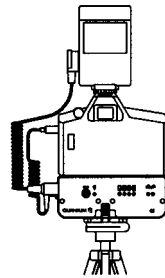

TURBO COMPACT

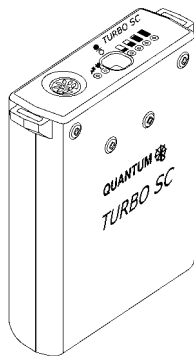

TURBO SC

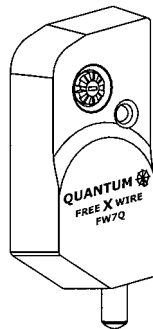

FW7Q

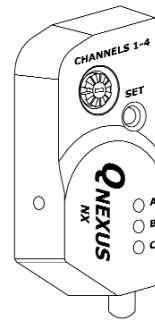

QNEXUS

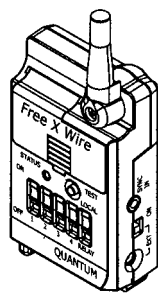

FREE X WIRE™



RADIO SLAVE

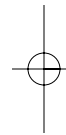
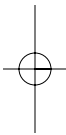

Quantum Instruments, Inc
10 Commerce Drive, Hauppauge NY 11788-3968 USA
Tel: 1-631-656-7400 Fax: 1-631-656-7410
www.qtm.com



P635

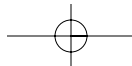

Free Manuals Download Website

<http://myh66.com>

<http://usermanuals.us>

<http://www.somanuals.com>

<http://www.4manuals.cc>

<http://www.manual-lib.com>

<http://www.404manual.com>

<http://www.luxmanual.com>

<http://aubethermostatmanual.com>

Golf course search by state

<http://golfingnear.com>

Email search by domain

<http://emailbydomain.com>

Auto manuals search

<http://auto.somanuals.com>

TV manuals search

<http://tv.somanuals.com>