

Quasar®

VHS

P2 ~ P10
Getting Started

P11 ~ P14
Basic TV Operation

P15 ~ P17
Basic VCR Operation

P18 ~ P20
More you Can Do

P21 ~ Back Cover
Other Information



COMBINATION-VCR

MODEL VV2507

OWNER'S MANUAL

Please read these instructions carefully before attempting to connect, operate or adjust this product. Please save this manual. Spanish Quick Use Guide is included. Guía para rápida consulta en español está incluido.

Things You Should Know

Congratulations

on your purchase of one of the most sophisticated and reliable products on the market today. Used properly, it will bring you and your family years of enjoyment. Please fill in the information at right. The serial number is on the tag located on the back of your Combination VCR.

Date of Purchase _____
Dealer Purchased From _____
Dealer Address _____
Dealer Phone No. _____
Model No. **VV2507** _____
Serial No. _____

Safety Precautions

Warning: To prevent fire or shock hazard, do not expose this equipment to rain or moisture.

This video recorder, equipped with the HQ (High Quality) System, is compatible with existing VHS equipment. Only use those tapes with the **VHS** mark. It is recommended that only cassette tapes that have been tested and inspected for use in 2, 4, 6, and 8 hour VCR machines be used.

This television receiver provides display of television closed captioning in accordance with §15.119 of the FCC rules.



 <p>CAUTION: TO REDUCE THE RISK OF ELECTRIC SHOCK, DO NOT REMOVE COVER (OR BACK) NO USER-SERVICEABLE PARTS INSIDE REFER SERVICING TO QUALIFIED SERVICE PERSONNEL</p>	 <p>This symbol warns the user that uninsulated voltage within the unit may have sufficient magnitude to cause electric shock. Therefore, it is dangerous to make any kind of contact with any inside part of this unit.</p>
	<p>This symbol alerts the user that important literature concerning the operation and maintenance of this unit has been included. Therefore, it should be read carefully in order to avoid any problems.</p>

Table of Contents

Important Safeguards and Precautions	3
Unpacking Your Combination VCR • Product Features.....	4
Getting Started	
Antenna or Cable Connections (Outdoor Antenna, Cable Box, Scrambled/Unscrambled Channels)	5
Location of Controls (Remote Control, Combination VCR).....	6, 7
One Time Setup (On-Screen Language, Channel Memory, Auto Clock Set).....	8, 9
On-Screen Displays (OSD) (Function, Channel, Menu, VCR Status/Clock, Warning, Instruction)	10
Basic TV Operation	
TV Operation (Main Operation, Using the 100 key, Rapid Tune, Audio Mute, Phones, Game mode).....	11
Picture Adjustment (Color, Tint, Bright, Picture, Sharpness, Reset).....	12
TV Timer Features (Alarm Timer, Sleep Timer)	13
Closed Caption System (Main Operation, Caption On Mute)	14
Basic VCR Operation	
Playback a Tape (Special Effects, Quality Picture Features)	15
Tape Operation (Repeat Play, One Minute Skip, Zero Search, Auto Functions)	16
Record On a Tape (Main Operation, One Touch Record, Input Select)	17
More You Can Do	
Timer Recording (Main Operation, Cancel, Clear, Replace Program)	18, 19
Copying Your Tapes (Connection, Main Operation)	19
Special VCR Features (VCR Lock, Warning Beeper)	20
Other Information	
Unit and Cassette Information	21
Before Requesting Service (Self-check Items)	22
Service Center List	23
Spanish Quick Use Guide/Guía para rápida consulta	24, 25, 26, 27
Warranty	Back Cover

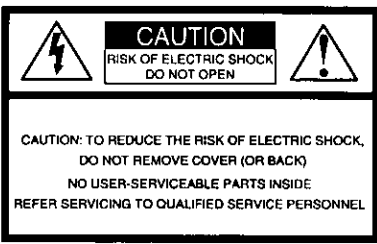

Important Safeguards and Precautions

FOR YOUR SAFETY, READ AND RETAIN ALL SAFETY AND OPERATING INSTRUCTIONS. HEED ALL WARNINGS IN THE MANUAL AND ON THE UNIT

INSTALLATION

1 POWER SOURCE CAUTION

Operate only from a power source indicated on the unit or in this manual.

If necessary, have your Electric Utility Service Company or Video Products Dealer verify the power source in your home.

2 POLARIZED OR GROUNDING PLUG

As a safety feature, this Video product comes with either a polarized power cord plug (one blade is wider than the other), or a three-wire grounding type plug.

POLARIZED PLUG CAUTION:

This plug will only fit into an outlet one way. If you cannot fully insert the plug, try reversing it. If it still will not fit, have an electrician install the proper wall outlet. Do not defeat the safety feature by tampering with the plug.

GROUNDING PLUG CAUTION:

This plug will only fit into a three-hole grounding outlet. If necessary, have an electrician install the proper outlet. Do not defeat the safety feature by tampering with the plug.

3 POWER CORD

Make sure power cords are routed so that they are not likely to have anything rest on them, roll over them, or be in the way of walking traffic.

If an extension cord is used, make sure it also has either a polarized or grounded plug and that the cords can be securely connected.

Frayed cords, damaged plugs, and damaged or cracked wire insulation are hazardous and should be replaced by a qualified service technician.

Overloaded outlets and extension cords are fire hazards and should be avoided.

4 DO NOT BLOCK VENTILATION HOLES

Ventilation openings in the cabinet release heat generated during operation. If they are blocked, heat build-up inside the unit can cause failures that may result in a fire hazard or heat damage to cassettes.

For protection follow these rules:

- Never cover ventilation slots or the unit while in use, or operate the unit when placed on a bed, sofa, rug, or other soft surface.
- Avoid built-in installation, such as a book case or rack, unless proper ventilation is provided.

5 AVOID EXTREMELY HOT LOCATIONS OR SUDDEN TEMPERATURE CHANGES

Do not place the unit over or near any kind of heater or regulator, in direct sunlight, inside a closed vehicle, etc.. Do not move the unit suddenly between areas of extreme temperature variation. If the unit is suddenly moved from a cold place to a warm place, moisture may condense in the unit and on the tape.

6 TO AVOID PERSONAL INJURY

- Do not place unsecured equipment on a sloping surface.
- Support for the unit should be firm, level, and adequately strong.
- An appliance and cart combination should be moved with care. Quick stops, excessive force, and uneven surfaces may cause the appliance and cart combination to overturn.
- Carefully follow all operating instructions and use the manufacturer's recommended accessories when operating this unit or connecting it to any other equipment.



OUTDOOR ANTENNA INSTALLATION

1 SAFE ANTENNA AND CABLE CONNECTION

If an outside antenna or cable system is connected to the equipment, be sure the antenna or cable system is grounded so as to provide some protection against built up static charges and voltage surges. Section 810 of the National Electrical Code, ANSI/NFPA 70 (in Canada, part 1 of the Canadian Electrical Code) provides

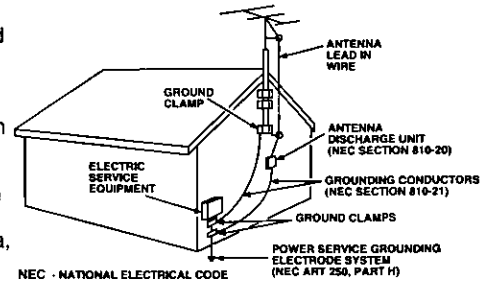

information with respect to proper grounding of the mast and supporting structure, grounding of the lead-in wire to an antenna discharge unit, size of grounding conductors, location of antenna discharge unit, connection to grounding electrodes and requirements for the grounding electrode.

2 KEEP ANTENNA CLEAR OF HIGH VOLTAGE POWER LINES OR CIRCUITS

An outside antenna system should be located well away from power lines, electric light or power circuits and where it will never come into contact with these power sources if it should happen to fall. When installing an outside antenna, extreme care should be taken to avoid touching power lines, circuits or other power sources as this could be fatal. Because of the hazards involved, antenna installation should be left to a professional.

USING THE VIDEO UNIT

If the unit has been in storage or moved to a new location, refer first to the INSTALLATION section of these safeguards.

1 KEEP THIS VIDEO UNIT AWAY FROM WATER OR MOISTURE OF ANY KIND.

2 IF EQUIPMENT IS EXPOSED TO RAIN, MOISTURE, OR STRONG IMPACT, unplug the unit and have it inspected by a qualified service technician before use.

3 DURING AN ELECTRICAL STORM

During a lightning storm, whether indoors or outdoors, or before leaving the unit unused for extended periods of time, disconnect all equipment from the power source as well as the antenna and cable system.

4 WHEN THE UNIT IS PLUGGED IN

- Never expose the unit to rain or water. DO NOT OPERATE if liquid has been spilled into the unit. Immediately unplug the unit, and have it inspected by a service technician. Fire and shock hazards can result from electrical shorts caused by liquid contact inside.
- Never drop or push any object through openings in the unit. Some internal parts carry hazardous voltages and contact can cause electric shock or fire hazard.
- Avoid placing the unit directly above or below your TV set as this may cause electrical interference. Keep all magnets away from electronic equipment.

5 USING ACCESSORIES

Use only accessories recommended by the manufacturer to avoid risk of fire, shock, or other hazards.

6 CLEANING THE UNIT

Unplug the unit. Then, use a clean, dry, chemically untreated cloth to gently remove dust or debris. DO NOT USE cleaning fluids, aerosols, or forced air that could over-spray, or seep into the unit and cause electrical shock. Any substance such as wax, adhesive tape, etc. may mar the cabinet surface. Exposure to greasy, humid, or dusty areas may adversely affect internal parts.

SERVICE

1 DO NOT SERVICE THIS PRODUCT YOURSELF

If, after carefully following the detailed operating instructions, this Video product does not operate properly, do not attempt to open or remove covers, or make any adjustments not described in the manual. Unplug the unit and contact a qualified service technician.

2 IF REPLACEMENT PARTS ARE REQUIRED

Make sure the service technician uses only parts specified by the manufacturer, or those having the same safety characteristics as the original parts. The use of unauthorized substitutes may result in fire, electric shock, or other hazards.

3 HAVE THE SERVICE TECHNICIAN PERFORM A SAFETY CHECK

After any service or repairs to the unit, request the service technician to conduct a thorough safety check as described in the manufacturer's service literature to insure that the video unit is in safe operating condition.

Unpacking Your Combination VCR • Product Features

Unpacking Your Combination VCR

The accessories shown below are provided to help you use or set up your Combination VCR.

Accessories

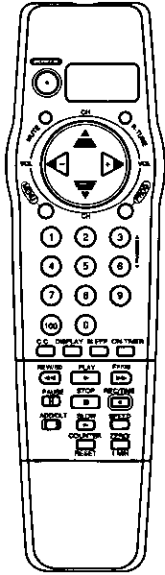

Remote Control
VSQS1485

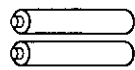

2 "AA" Batteries

To order accessories,
call toll free 1-800-332-5368.

Load the batteries

1 Push in and up on the latch with your thumb nail and lift off the lid.

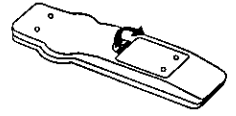

2 Install two batteries as indicated inside the Battery Compartment.

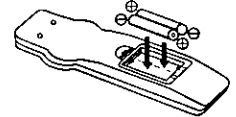

3 Fit the lid's hinge piece into the indent on the case, and snap the lid into place.

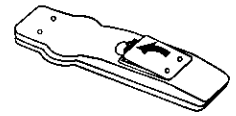

Battery replacement caution

- Do not mix old and new batteries.
- Do not mix alkaline with manganese batteries.

Product Features

Alarm Timer	13
All Channel Auto Set/181-CH TV/CATV Tuner	8
Auto Clock Set	8, 9
Auto Daylight Saving Time	21
Auto Operation Functions (Auto Shut Off, Auto Playback, Rewind, Tape Eject, Power Off)	16
Auto Repeat Function	16
Black Tube	15
Closed Caption System	14
Easy-to-Read English/Spanish/French On-Screen Displays	8, 9, 18, 19
Front-mounted A/V In Terminals	19
Game Mode	11
One Minute Skip	16
One Month, 8 Program Auto Timer Recording	18, 19
One Touch Recording (OTR)	17
Quick Play Mechanism	22
Rapid Tune	11
Special Effects Playback	15
Special VCR Features (VCR Lock, Warning Beeper)	20
Zero Search	16



Antenna or Cable Connections

Outdoor Antenna Connection

Unhook the antenna from your previous TV or VCR and connect it to the back of the Combination VCR as shown in the diagram. If your antenna system has separate UHF and VHF lead-ins, you need a UHF/VHF Band Mixer (not supplied).

(Flat)Twin Lead
300 Ohm Cable

UHF/VHF
Band Mixer
(not supplied)

(Round) 75 Ohm
coaxial Cable

or

300-75 ohm
Transformer
(not supplied)
from
Antenna

(Flat)Twin Lead
300 Ohm Cable

Back of
Combination VCR

Cable Connections

(A) Without a Converter/Descrambler Box

With this connection, you can use your Combination VCR remote control to select channels for viewing and select unscrambled channels for timer recording. Scrambled channels may not be viewed or recorded with this connection.

(B) With a Converter/Descrambler Box

With this connection, you may record and view any channel including scrambled channels. Please note, however that channel selection must be made at the cable company converter box. Timer recording is limited to one channel at a time, and you can only view the channel you are recording.

(A)

Back of Combination VCR

from CATV
(cable)

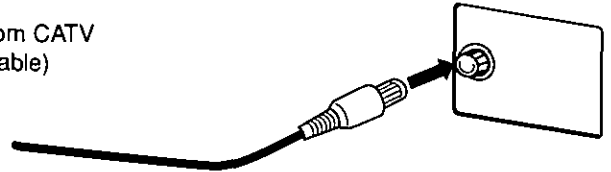

(B)

Cable TV Converter Box

from CATV
(cable)

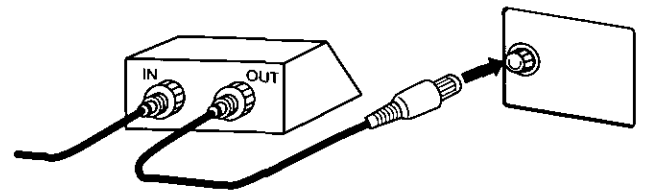

To Watch and Record Scrambled/Unscrambled Channels

Set the Combination VCR to the output channel of the cable converter box (e.g. CH3). Now, select channels to be viewed or recorded at the cable converter box.

FCC WARNING: Any unauthorized changes or modifications to this equipment would void the user's authority to operate.

Note to CATV System Installer

This reminder is provided to call the CATV (Cable TV) System Installers attention to Article 820-40 of the NEC that provides guidelines for proper grounding and, in particular, specifies that the cable ground shall be connected to the grounding system of the building, as close to the point of cable entry as practical.



Location of Controls

Remote Control Button

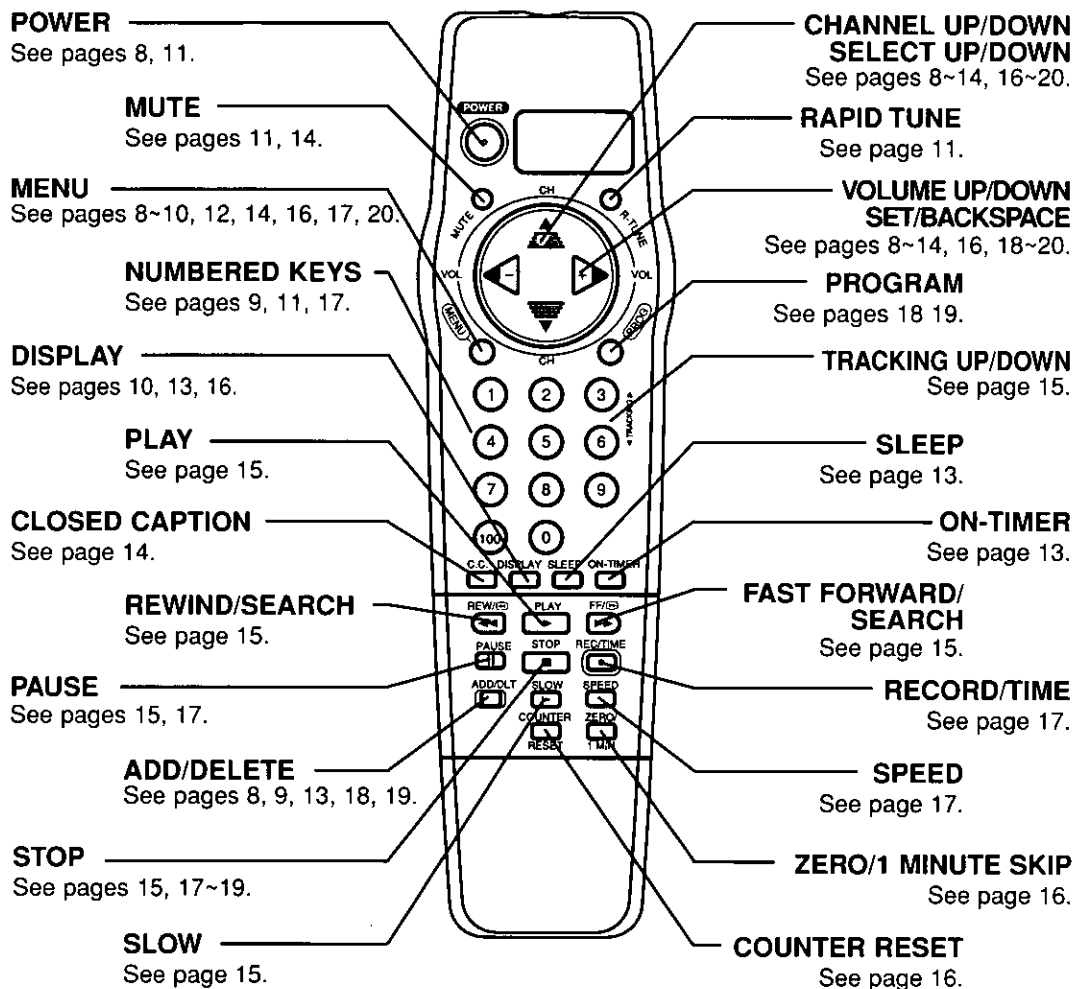

Indicators on the Front Panel

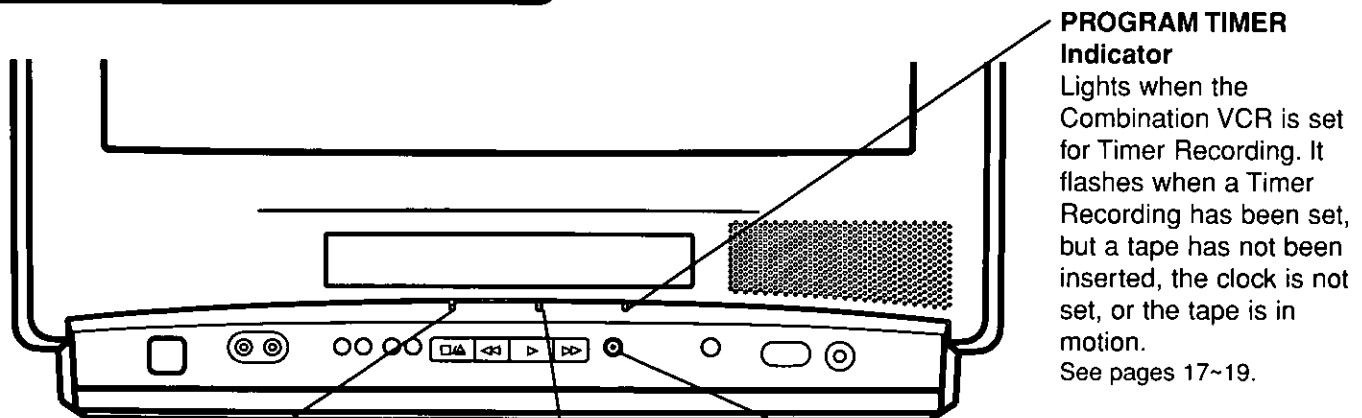

ON TIMER Indicator
Lights when the On Timer is set.
See page 13.

REPEAT Indicator
Lights when "REPEAT PLAY: ON" is selected and playback is in progress.
See page 16.

RECORD Indicator
Lights during recording. In Rec Pause or OTR Pause mode, the indicator flashes.
See page 17.

PROGRAM TIMER Indicator
Lights when the Combination VCR is set for Timer Recording. It flashes when a Timer Recording has been set, but a tape has not been inserted, the clock is not set, or the tape is in motion.
See pages 17~19.

Front View of the Combination VCR

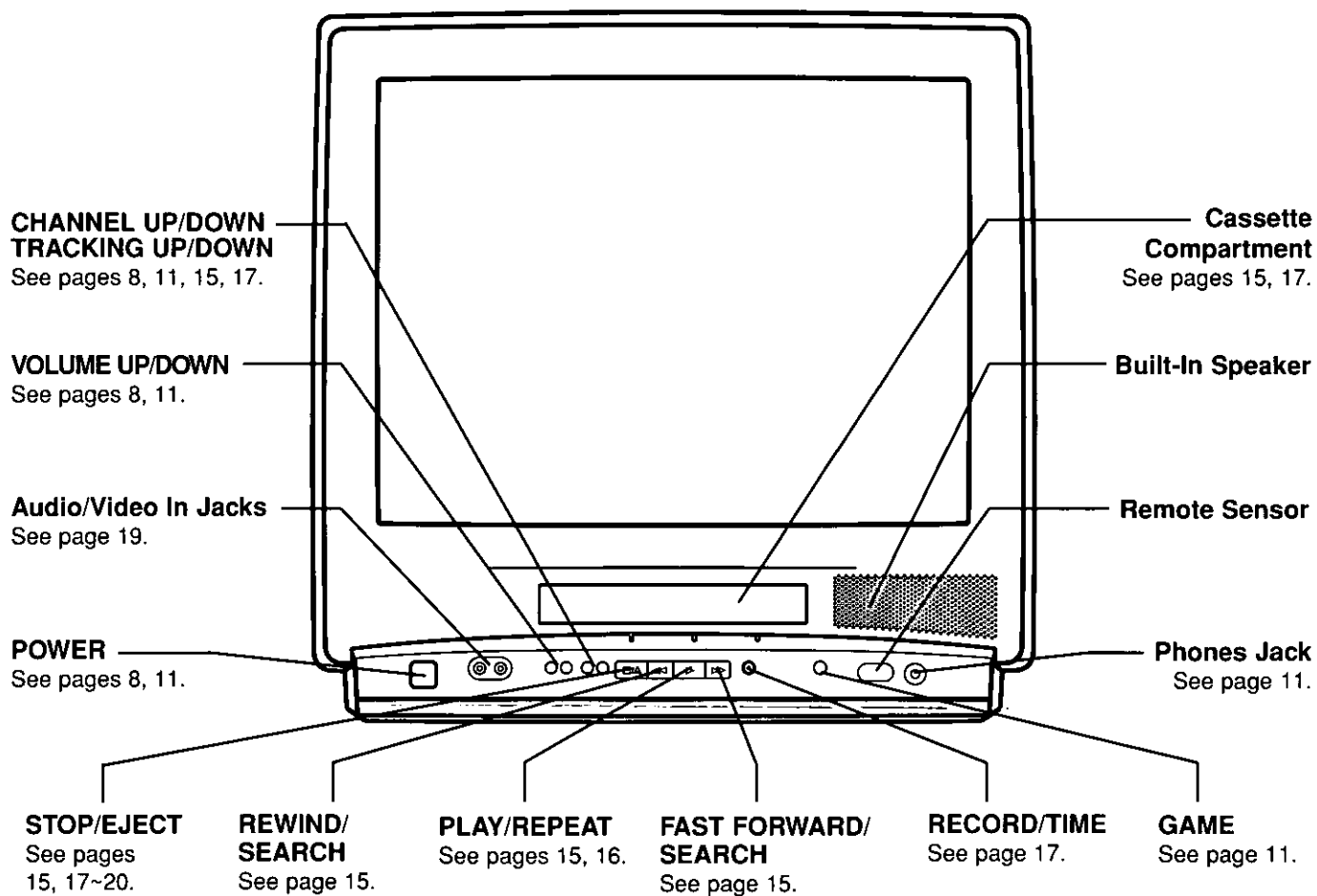

Rear View of the Combination VCR

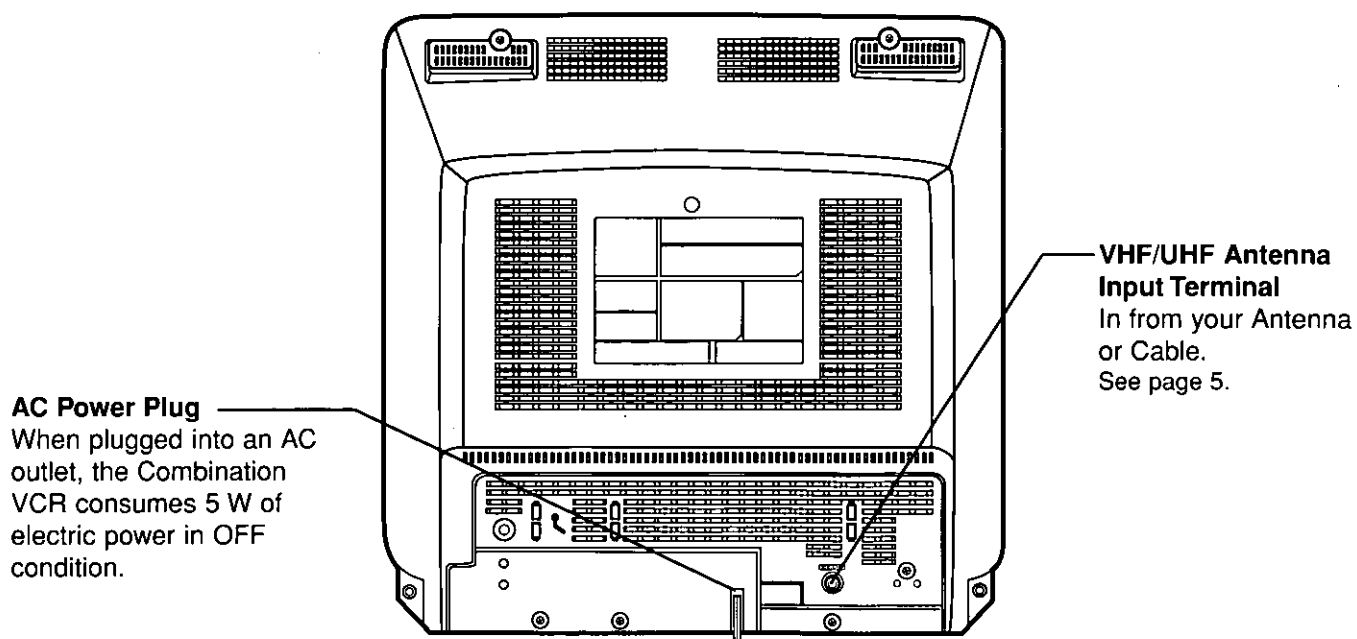



One Time Setup

✓ Check list before you begin.

- Your Combination VCR is connected to an Antenna, or Cable system (see page 5).

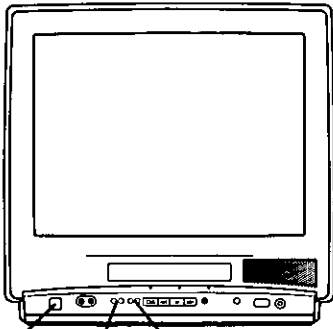

① ② ② ③ ④

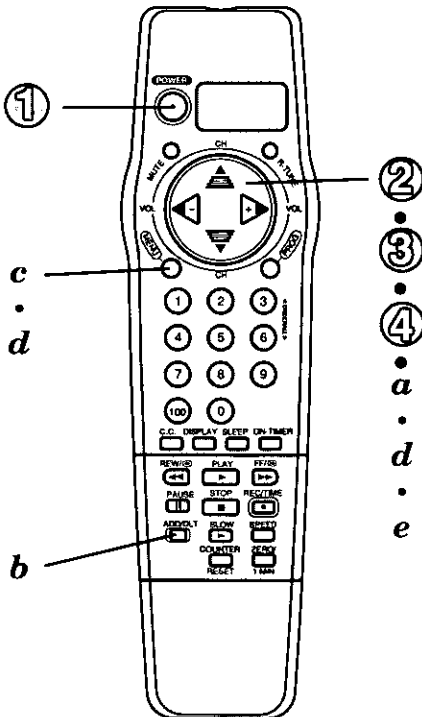

To Set Language, Channels, and Clock

When the Combination VCR power is first turned on, the Select Language and Channel/Clock Auto Set screens appear automatically.

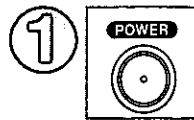

1 Push **POWER** to turn the Combination VCR on.



2 Push **▲**, **▼** or **▶** for on-screen displays in English, Spanish or French.

- If you choose the wrong language, please see the "Reset all Combination VCR Memory Functions" section on page 21.
- If you use a cable box, the cable box must be left on for auto channel set.

SELECT LANGUAGE

PUSH CH ▲ :English
PULSE CH ▼ :Español
APP. VOL + :Français



3 **Important: If you use a cable box, turn it on and select the PBS station in your time zone.**

Push **▲** to start Channel Auto Set and Clock Auto Set.

CHANNEL/CLOCK AUTO SET

CONNECT ANTENNA CABLE AND IF YOU USE A CABLE BOX, TUNE IT TO YOUR LOCAL PBS CH THEN...

PLEASE PUSH CH UP KEY

These on-screen displays will appear in sequence.

- CH AUTO SET PROCEEDING
- CH AUTO SET COMPLETED
- AUTO CLOCK SET PROCEEDING

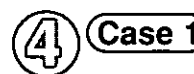
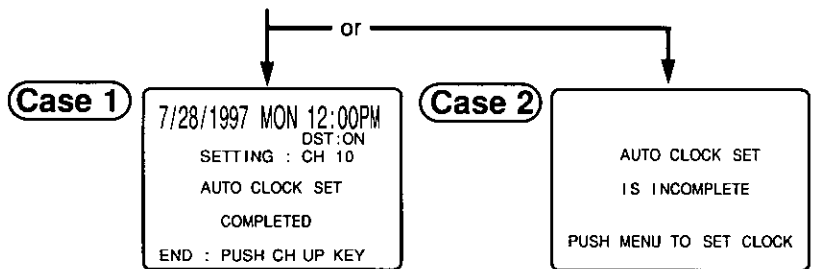

4 **Case 1** Confirm that displayed time is correct, and then push **▲** to exit.

If the displayed time and D.S.T. are incorrect

In the rare event that you live within broadcast range of two PBS stations in two different time zones, the Combination VCR may recognize the wrong PBS station. To correct this situation, do the following:

- Make a note of the SETTING: CH number shown on-screen and push **▲** to exit.
- Delete the setting channel from the Combination VCR channel memory. (See the Add or Delete a Channel section on the next page.)
- Push **MENU** to display the menu.
- Push **▲ ▼ ◀ ▶** to select "CLOCK," and then push **MENU** to display the SET CLOCK screen.
 - If you use a cable box and have multiple PBS stations, tune the cable box to a different PBS station and try auto clock set again using the menu.
- Push **▲ ▼** to select "AUTO SET," and then push **▶** to set and to **▲** start Auto Clock Set.

Using the **▲ ▼ ◀ ▶** keys

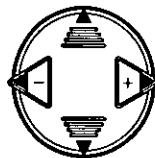

Whenever a menu or program screen is displayed, CHANNEL UP/DOWN and VOLUME UP/DOWN on the remote control function as **▲ ▼ ◀ ▶** only. For VOLUME UP/DOWN functions, use the buttons on the Combination VCR.



- Auto clock set will be performed when the Combination VCR is turned off the first time each day. If you use a cable box and you want auto clock set to be performed, the cable box must be left on and tuned to the PBS channel at the time the Combination VCR power is turned off.
- If for any reason the time is changed manually, automatic time correction will not occur.

Case 2 If AUTO CLOCK SET IS INCOMPLETE appears, please set the clock manually.

a. Push MENU to display the SET CLOCK screen.

b. Push ▲ ▼ to select and ▶ to enter the month, date, year, time, and D.S.T. (Daylight Saving Time).

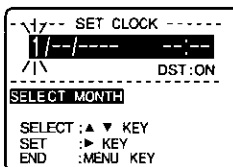

To Make Corrections,

push ◀▶ repeatedly to move back or forward to the desired item.

c. Push MENU to start the clock. Then, push ▲ ▼ ◀▶ to select "EXIT." Now, push MENU to exit the MAIN MENU.

• "DST:ON" automatically adjusts for daylight saving time. (See page 21.)

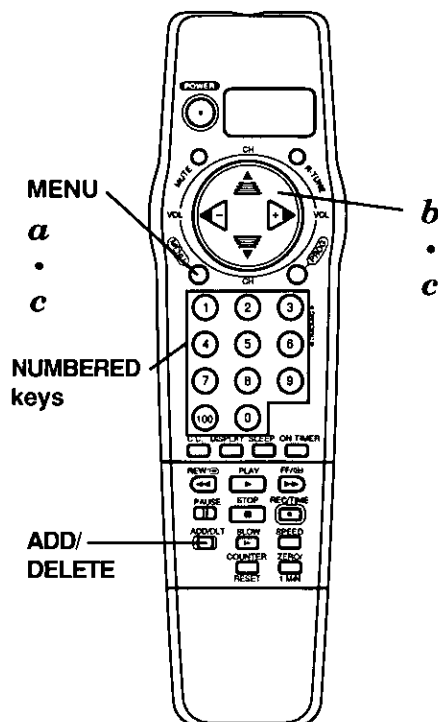

To Change or Re-enter One Time Setup Items

To Change the OSD Language

- 1 Push MENU to display the MAIN MENU.
- 2 Push ▲ ▼ ◀▶ to select the language selection icon.
- 3 Push MENU repeatedly to change the language as shown.

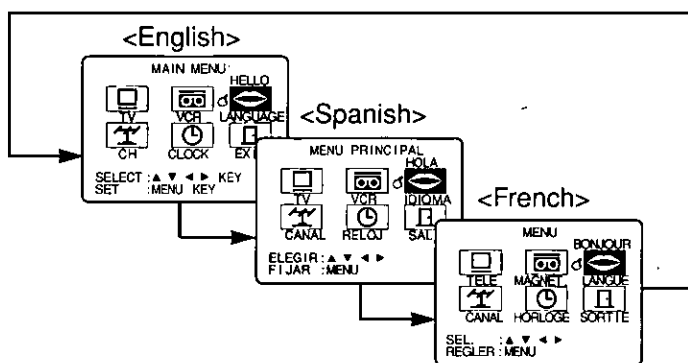

4 Push ▲ ▼ ◀▶ to select "EXIT," and then push MENU to exit the MAIN MENU.

To Replace Channels in Memory

In case, you have cable installed, etc.

1 Push MENU to display the MAIN MENU.

2 Push ▲ ▼ ◀▶ to select "CH," and then push MENU to display the SET UP CHANNEL screen.

3 Push ▲ ▼ repeatedly to select ANTENNA SYSTEM, and then push ▶ to select your antenna system (TV or CATV).

4 Push ▲ ▼ to select AUTO SET, and then push ▶ to start.

- To exit this mode, push MENU. Then, push ▲ ▼ ◀▶ to select "EXIT." Now, push MENU to exit the MAIN MENU.

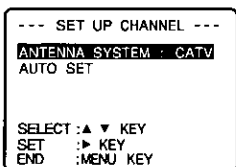
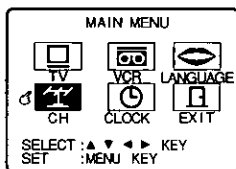

To Set or Reset the Clock

In case the clock is wrong, or a power failure occurred.

- 1 Push MENU to display the MAIN MENU.
- 2 Push ▲ ▼ ◀▶ to select "CLOCK." Then, push MENU to display the SET CLOCK screen.
- 3 Push ▲ ▼ to select "MANUAL SET," and then ▶ to display the SET CLOCK screen.
- 4 Please do steps b and c at the top of this page.

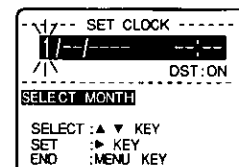
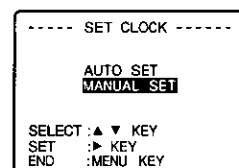

To Add or Delete a Channel

1 Select a channel using the NUMBERED keys to add or the CH ▲ ▼ to delete.

2 Push the ADD/DLT to add or delete the channel.

- To select a channel once it's deleted, use the NUMBERED keys.

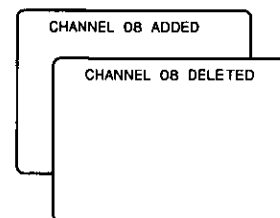

NOTES

- This Combination VCR will accurately maintain its calendar up to Dec. 31, 2089, 11:59PM.
- Normal TV or Cable channels are automatically selected and placed in memory depending on how your Combination VCR is hooked up.



On Screen Displays (OSD)

Channel & Function Display

Whenever the channel is changed, the channel number will appear for a few seconds on-screen. (Some station names may also appear.)

When a function button is pushed (PLAY, FF, etc.), the Combination VCR mode will be displayed.

- When a recording is started, both REC and the channel number will appear together.

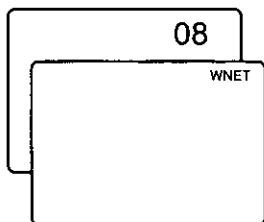

Menu Screen

- 1 Push MENU to display the MAIN MENU.
- 2 Push ▲ ▼ ◀ ▶ and MENU to make your selection (see page 8).

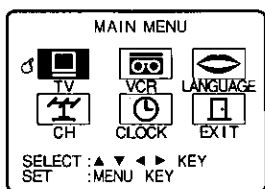

- To get the most from each feature, please read the Operation Manual before attempting any operation.

VCR Status & Clock Display

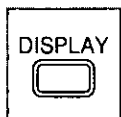

Push DISPLAY to display and remove the overlay shown below.

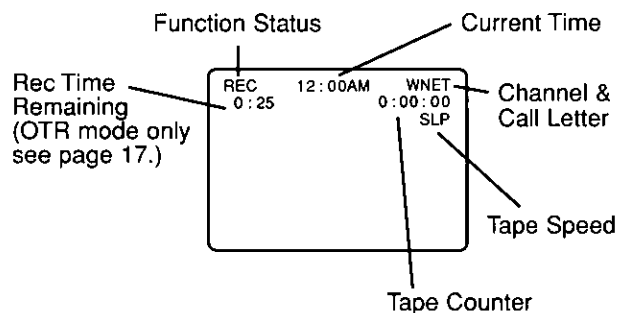

Blank Tape/ No Video Signal Indication

When a blank section of tape comes up in Play mode, or the selected channel has no broadcast signal, the TV screen will turn a solid blue.

Warning and Instruction Displays

These displays will alert you of a missed operation or provide further instructions.

If no active channels are found for CHANNEL MEMORY... (see page 5.)

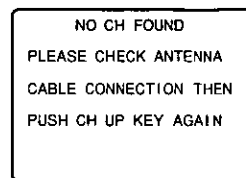

If you attempt to set or review a Timer Recording or set the On Timer and the Clock is not set... (see pages 8, 9.)

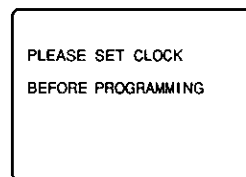

If a Timer Program was not completed before exiting the Program mode... (see pages 18, 19.)

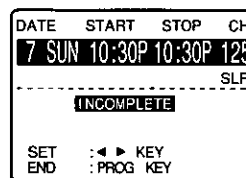

If you push REC on the remote control or the Combination VCR, and a cassette is inserted with no record tab... (see page 21.)

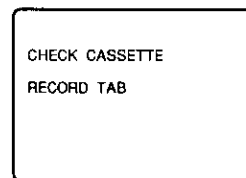

If you push STOP during a Timer Recording... (see page 19.)

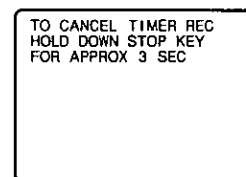

If you push PLAY, FF, REW, or REC on the remote control or the Combination VCR without a cassette inserted... (see pages 15, 16, 17.)

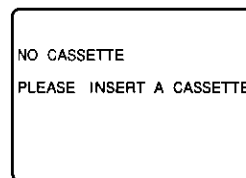

If the Combination VCR is not in Stop mode or a cassette with record tab is not inserted two minutes before a Timer Recording is about to begin... (see pages 18, 19.)

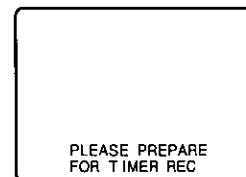

If head cleaning becomes necessary while playing back a tape... (see page 21.)

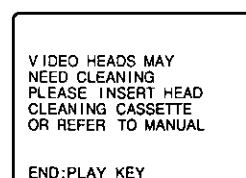

If you push a function button other than STOP/EJECT or POWER while the Combination VCR is in VCR Lock mode... (See page 20.)

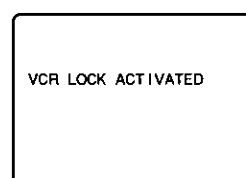



TV Operation

✓ Check list before you begin.

- All connections are made (see page 5).
- Your Combination VCR is plugged in.

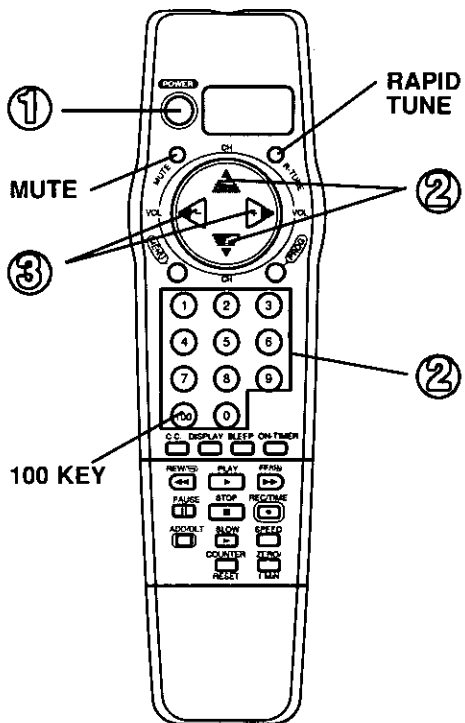
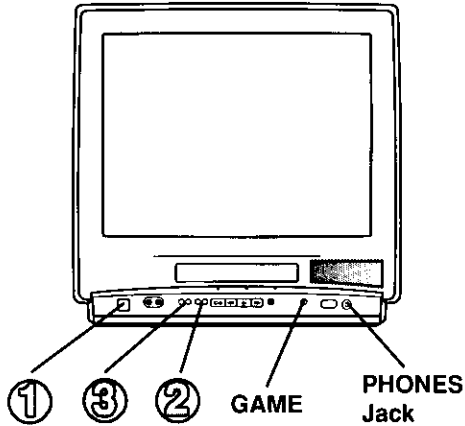

① Push **POWER** to turn the Combination VCR on.

② or Select a channel using or the **NUMBERED** keys.

③ Push **VOL** to adjust the volume level.



Using the 100 key

When selecting CATV channels 100 to 125 with the **NUMBERED** keys, first push the 100 key, and then enter the remaining two digits. For example, for channel 125: Push **NUMBERED** keys 100-2-5.

Rapid Tune

Push **R-TUNE** to display the last channel you were watching.

- When selecting channels with **CH** , the channels must be displayed for at least 4 seconds in order for the Combination VCR to recognize them as a new selection.

Previous channel	Present channel
CH08	CH10

Audio Mute

Push **MUTE** to instantly mute the sound. Push again, to restore the previous sound level.

Phones

Connect an earphone (not supplied) or headphones (not supplied) to the **Phones Jack**.

Game Mode Feature

This feature adjusts the color and picture intensity levels so the screen is easier on the eyes when video games are played.

- This Combination VCR contains no video game software.

Push **GAME** on the Combination VCR to select "ON".

- "GAME" is displayed for 4 seconds.

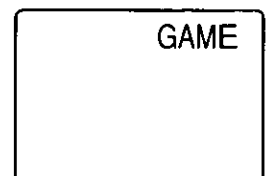

To Cancel the Game Mode, push **GAME** again.

- The previous color and picture settings will be restored.

NOTES

- This feature is not available when tape playback is in progress.
- Game mode is turned off when one of the following functions is performed:

• Power is turned Off	• Play mode is entered
• Channel is changed	• Power failure occurs
• Input signal is changed	



Picture Adjustment

✓ Check list before you begin.

- All connections are made (see page 5).
- Your Combination VCR is plugged in.

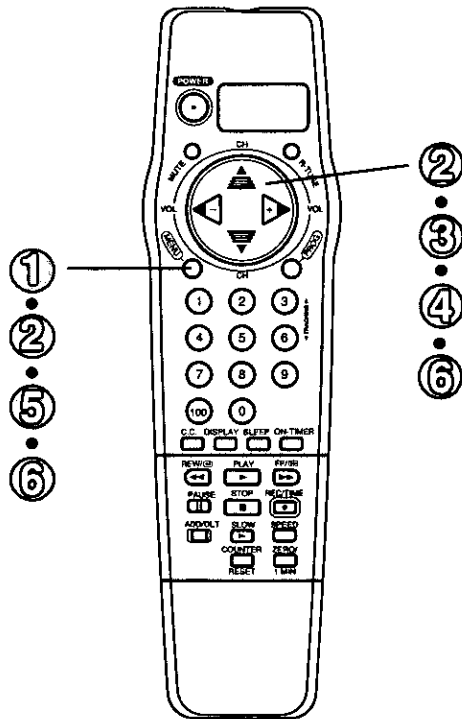

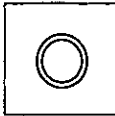
①  Push MENU to display the MAIN MENU.

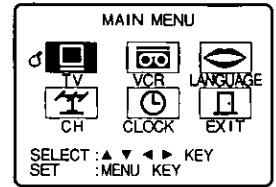

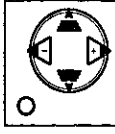
②  Push ▲ ▼ ◀ ▶ to select "TV," and then push MENU to display the SET UP TV screen.

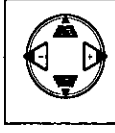
③  Push ▲ ▼ to select "VIDEO ADJUST," and then push ▶ to display the VIDEO ADJUST screen.

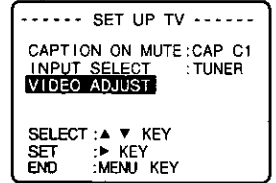

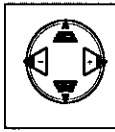
④  Push ▲ ▼ repeatedly to select the desired adjust item, and then push ◀ ▶ to adjust. (See description below.)

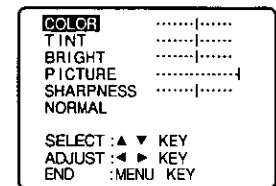

Picture Adjustment

COLOR Control

To adjust the intensity of the color.

TINT Control

To adjust for the most natural fleshtones.

BRIGHT Control

To adjust the brightness of the picture.

PICTURE Control

To adjust the intensity of the picture by adjusting contrast and color level at the same time and in the proper balance.

SHARPNESS Control

To adjust the sharpness of the picture.

To Reset Picture Controls to the Factory Setting

Push ▲ ▼ and ▶ to select and set NORMAL.

All controls return to their factory settings.

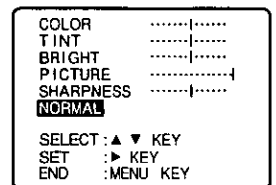

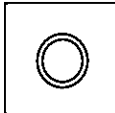
⑤  Push MENU twice to exit the VIDEO ADJUST mode.

- If no button is pushed within 5 minutes, the video adjust overlay disappears.

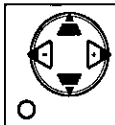
⑥  Push ▲ ▼ ◀ ▶ to select "EXIT," and then push MENU to exit the MAIN MENU.



TV Timer Features

✓ Check list before you begin.

- All connections are made (see page 5).
- Your Combination VCR is plugged in.

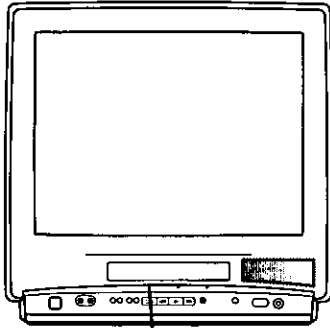

ON-TIMER Indicator

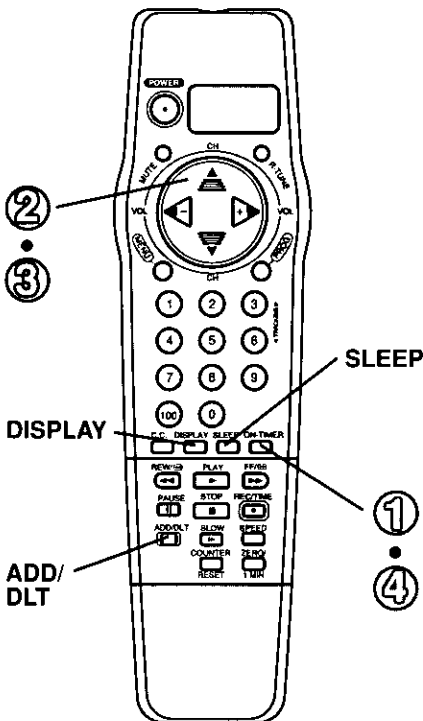

On-Timer with Alarm Feature

The Combination VCR can be set to automatically power on in one of 2 modes (TV or Playback). You can also combine the On-Timer with a one minute alarm that gradually increases in volume.



1 Push ON-TIMER to display the ON TIMER screen.

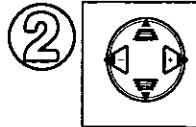
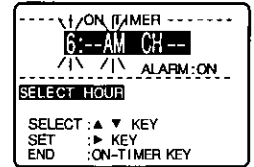

2 Push ▲ ▼ to select and ► to fix the On Timer time and also to choose the On Timer mode (TV or PLAY).

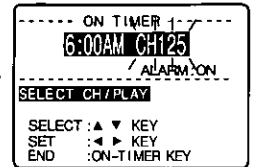

- Make sure a tape is inserted if VCR Playback mode is selected.

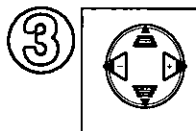

3 Push ▲ ▼ to select alarm "ON" or "OFF".

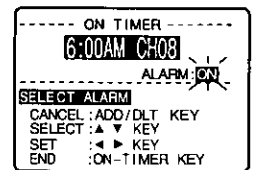

When "ON" is selected, an alarm will gradually increase in volume for one minute or until cancelled by pushing any button on the remote or Combination VCR (including Volume UP/DOWN). When the alarm sound stops, the sound of the mode you selected will ensue.

To Make Corrections,

use ▲ ▼ and ◀ ▶ to move back and correct as necessary.



4 Push ON-TIMER to set the On Timer. This screen will appear for about 5 seconds.

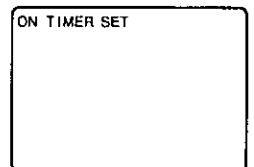

- The ON-TIMER indicator lights on the front panel.

To Cancel,

push ON-TIMER to redisplay the screen in step 3. Then, push ADD/HLT to clear the time ("6" is flashing). Now, push ON-Timer to end. "ON TIMER END" appears on-screen for a few seconds.

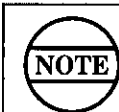

If no button on the remote or Combination VCR (including a button used to turn off the alarm) is pushed within 60 minutes after the Combination VCR turns itself on, it will turn itself back off.

Set the Sleep Timer

The Combination VCR can be set for auto power off.

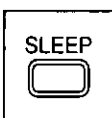

Repeatedly push SLEEP to set the sleep timer.

- Each push will change the time in the order shown at right.

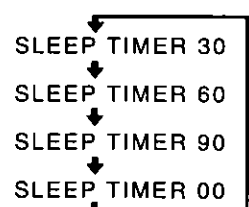

- If you push DISPLAY with the SLEEP TIMER set, the remaining time will appear on-screen.

To Cancel, push SLEEP repeatedly until "SLEEP TIMER 00" appears.

CC Closed Caption System

This multi-use system not only allows the hearing impaired to enjoy selected programs, but also makes useful information from TV stations available to everyone.

✓ Check list before you begin.

- All connections are made (see page 5).
- Your Combination VCR is plugged in.

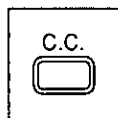
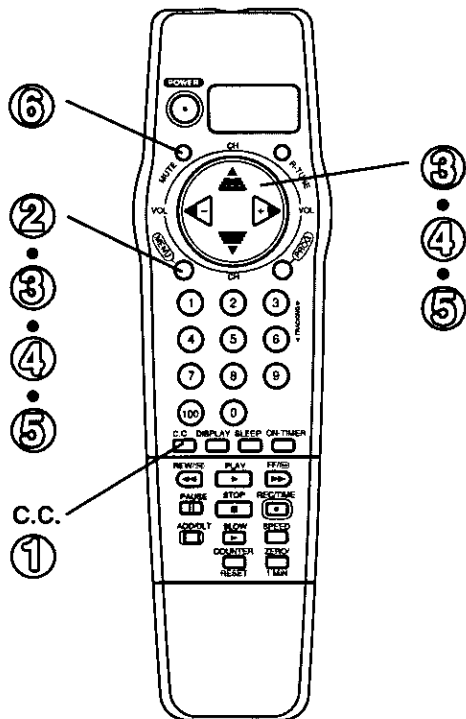

Push C.C. repeatedly to select the desired Caption Mode (see "Caption Mode description" below).

- Selected mode is displayed on screen.
- Each push of C.C. will change the Caption Mode as shown at right:

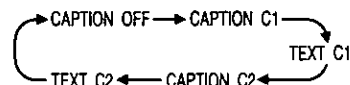

Closed Caption Modes to Choose From

Caption Mode: CAPTION C1 or C2

A narration of selected TV programs will be displayed on the screen. Check your TV program listings for C.C. (Closed Captioned) broadcasts.

Caption Mode: TEXT C1 or C2

The lower half of the screen will be blocked out. When the TV station broadcasts text, such as program listings, special information, etc., it will appear in this space.

Caption Mode: OFF

Narration will not appear on the screen even if a closed caption or text broadcast is received.

- The closed caption or text signal may be broadcast over C1, C2, or both. Also, text contents can vary so you may wish to try different settings.

Caption On Mute Feature

This feature allows you to turn off the sound and, at the same time, display Closed Caption narration. Perfect for when you need silence, but would like to continue enjoying the program.

1

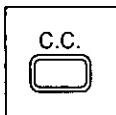

Push C.C. until CAPTION OFF is displayed on screen.

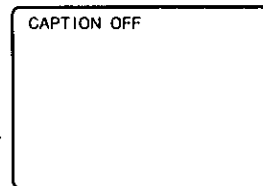

2

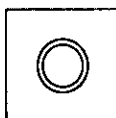

Push MENU to display the MAIN MENU.

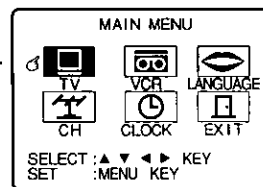

3

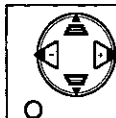

Push ▲ ▼ ◀ ▶ to select "TV," and then push MENU to display the SET UP TV screen.

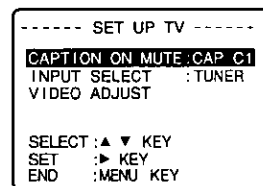

4

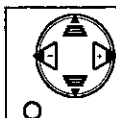

Push ▶ repeatedly to select the desired caption on mute mode, and then push MENU to exit the SET UP TV screen.

- Each push of |▶ will change the display as shown at right.

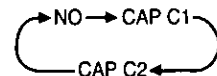

5

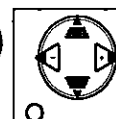

Push ▲ ▼ ◀ ▶ to select "EXIT," and then push MENU to exit the MAIN MENU.

6

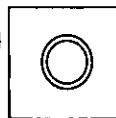

Push MUTE to mute the sound. The closed caption narration if available is displayed on the screen.

- Push MUTE again to resume normal sound and picture.

Recording and Playing Back a Closed Caption/Text Program

Record: Your Combination VCR will automatically record the Closed Caption/Text signal. Just follow normal recording operation.

Playback: To display the Closed Caption narration or Text during playback, simply push C.C. until the desired Caption Mode is displayed.

▶ Playback a Tape

✓ Check list before you begin.

- All connections are made (see page 5).
- Your Combination VCR is plugged in.

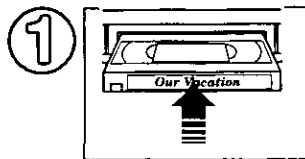
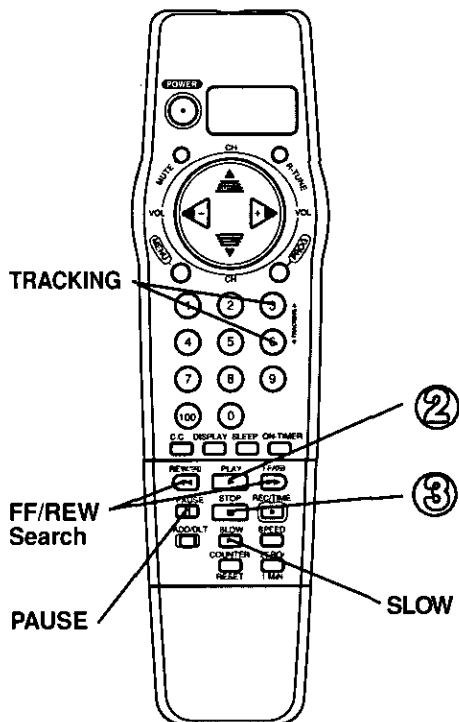
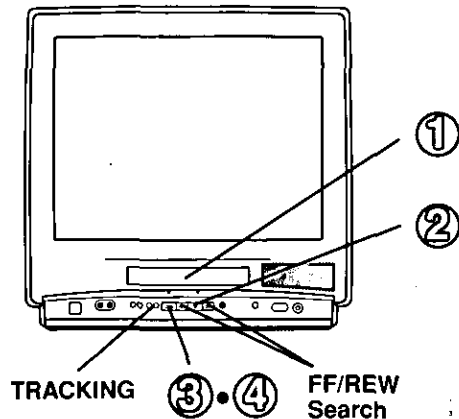

- ① Insert a cassette.
- Combination VCR power comes on automatically.



- ② Push PLAY on the remote control or Combination VCR to start playback.
- Playback begins automatically if cassette has no record tab (see page 16).



- ③ Push STOP on the remote control or Combination VCR to stop playback.



- ④ Push STOP/EJECT on the Combination VCR to eject the cassette.
- You may eject a cassette with power on or off.

To Find a Particular Scene During Playback



- Push REW or FF on the remote control or Combination VCR to quickly locate a scene.

- SLP mode tapes have a search speed of 27 times the normal speed.
- Some noise bars will appear during search.

Special Effects During Playback

These features work best in SLP mode. The sound will be muted.

Slow Motion Playback

Push SLOW to start slow motion playback. Push PLAY or SLOW to release.

Still (Freeze) Frame Picture

Push PAUSE to freeze and release the picture.

- To reduce picture noise, first push SLOW. Then, use the 3 or 6 NUMBERED keys on the remote control or CH UP/DOWN on the Combination VCR to clear up the picture, then push PAUSE.

Frame by Frame Advance

While in Still mode, push SLOW repeatedly or hold down to advance the still picture one frame at a time. Push PAUSE or PLAY to release.

(After the Combination VCR is in Still or Slow mode for 3 minutes, it will switch to the Stop mode automatically to protect the tape and the video head.)

Features for a Quality Picture

Digital Auto Tracking

This feature continuously analyzes the signal and adjusts for optimum picture quality.

Manual Tracking Control

Use during Playback and Slow Motion mode to reduce picture noise. Push the 3 or 6 NUMBERED key on the remote control or CH UP/DOWN on the Combination VCR until the picture clears up. To return to Auto Tracking, push POWER off and then on again.

Black Tube

This Combination VCR uses a Black picture tube for better color reproduction and picture contrast.

Caution:

Please inspect your cassette tapes for any loose or peeling labels as they may become jammed in your unit.

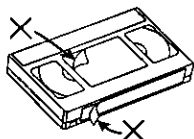



Tape Operation

Your Combination VCR is equipped with several time saving features as well as convenient automatic functions which make tape operation easier than ever.

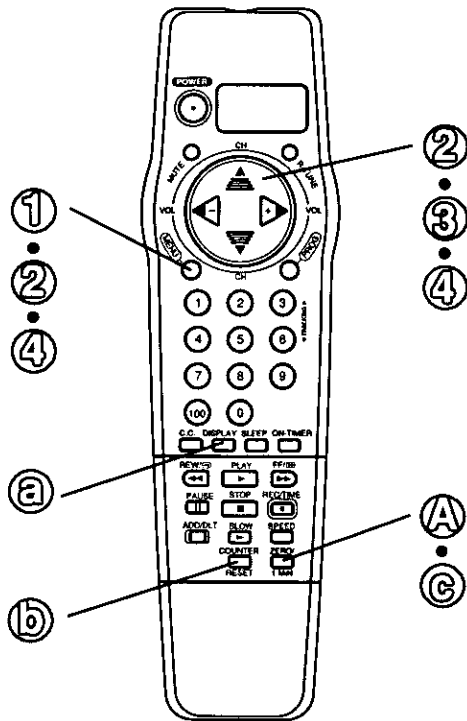



Repeat Play

You can set your Combination VCR up to play a recording over and over.

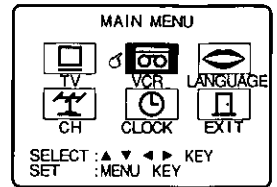
①  Push MENU to display the MAIN MENU.

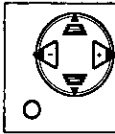

②  Push ▲▼◀▶ to select "VCR," and then push MENU to display the SET UP VCR screen.

③  Push ▶ repeatedly to select "ON" or "OFF."

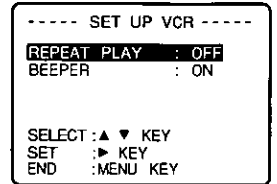

- When REPEAT PLAY : ON is selected, (the REPEAT indicator lights on the front panel), the Combination VCR will playback the tape to its end, or until a blank portion of 30 seconds or more is reached. (Erased portions of tape are not considered blank.) The tape is then automatically rewound and played again. This operation is repeated until you cancel Repeat Play.
- All function buttons (REW, FF, etc.) are operational during Repeat Play.

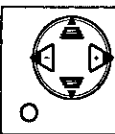
④  Push MENU to exit the SET UP VCR screen. Then, push ▲▼◀▶ to select "EXIT." Now, push MENU to exit the MAIN MENU.

NOTE You may also turn the repeat play feature on and off at the Combination VCR. During playback, push PLAY once or twice until the REPEAT indicator lights up (ON), or goes out (OFF).

Auto Operation Functions

Auto Shut Off

In TV or Game mode, when a broadcast signal is not received for 5 minutes, the Combination VCR will automatically power off (except when LINE INPUT is selected).

In Playback mode, when a Video signal is not detected for 5 minutes, the Combination VCR will automatically power off and the tape will be rewound.

- This feature is deactivated when any button on the unit or remote control is pushed even if there is no signal present.

Auto Playback

When a tape is inserted, the power turns on (Auto). If the record tab* is removed, playback begins (Auto).

Auto Rewind

When a tape reaches its end during playback or fast forward, the Combination VCR will rewind the tape and go into Stop mode.

Playback Auto Eject (Repeat Play is "OFF.")

When a tape without a record tab* is played to its end, the Combination VCR will rewind and then eject the tape.

Rec Auto Eject

After a tape reaches its end during normal recording, the Combination VCR will rewind and then eject the tape.

Memory Rewind Off

When POWER is pushed during tape rewind, rewinding will be completed even though the Combination VCR turns off.

*For record tab information, see page 21.

One Minute Skip

With this feature, you can skip over commercials recorded on a tape.

A  Push ZERO/1MIN in Play mode.

- The Combination VCR will go into FF search mode and skip over 60 seconds of recorded time. Then, normal playback will resume.

Zero Search

You can reset the Time Counter to zero and then return to that point.

a  Push DISPLAY to display the Time Counter overlay.

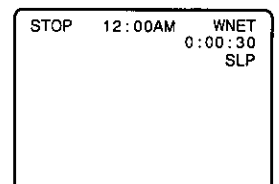

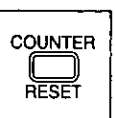
b  Push COUNTER RESET where desired to reset the Time Counter to 0:00:00.

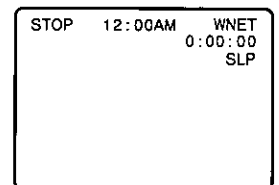

c  Push ZERO/1MIN in Stop mode.

- The Combination VCR will go into FF or REW mode and stop at the last point the Time Counter was set to 0:00:00.

Record On a Tape

✓ Check list before you begin.

- All connections are made (see page 5).
- Your Combination VCR is plugged in.

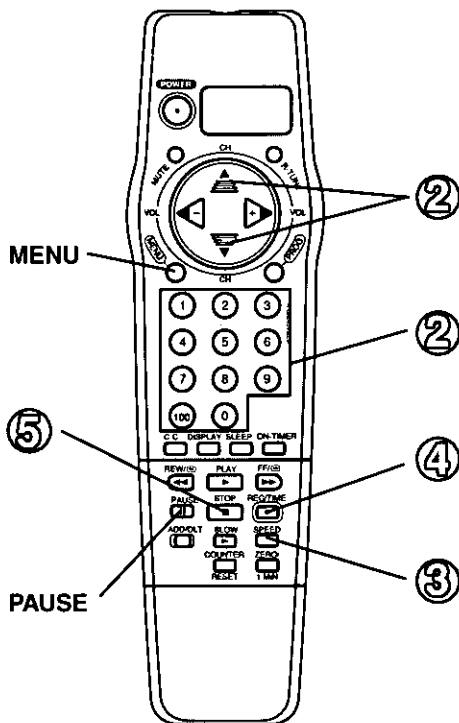
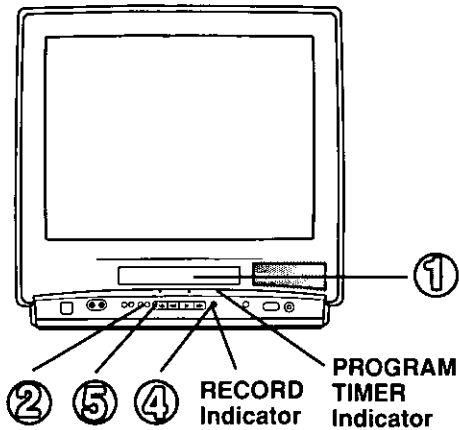

1 Insert a cassette with record tab.

- The Combination VCR power comes on automatically.

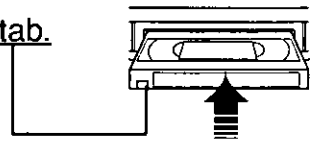

2 Push ▲ ▼ or NUMBERED keys on the remote control to select a channel.

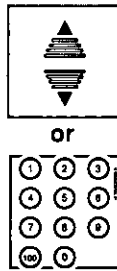

- Or, push CH UP/DOWN on the Combination VCR.
- To record from an outside source, push ▲ ▼ to select LINE input (see bottom of the page).

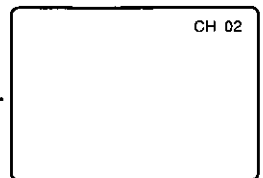

3 Push SPEED repeatedly until the desired tape speed is displayed (See page 21).

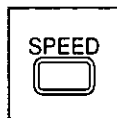

- SP = Standard Play
- LP = Long Play
- SLP = Super Long Play

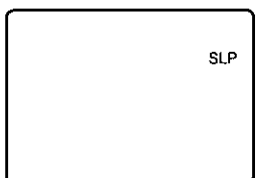

4 Push REC/TIME on the remote control to start recording.



- Or, push REC/TIME on the Combination VCR.
- To edit out unwanted portions, push PAUSE to pause the recording in progress. To release, push PAUSE again.

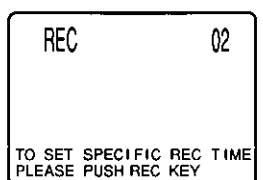

One Touch Timer Recording (OTR)

The Combination VCR stops recording at a preset time. In step 4, push REC/TIME repeatedly to set the length of the recording. Each push will change the time as shown.

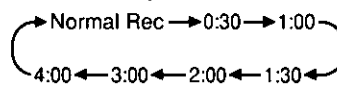

- The PROGRAM TIMER indicator lights on the front panel.

5 Push STOP on the remote control to stop recording.

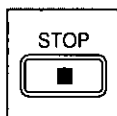

- Or, push STOP/EJECT on the Combination VCR.



- While it is possible to change the tape speed when you are recording, there will be some distortion on the tape where the change occurred.
- The remaining recording time of an OTR can be displayed by pushing DISPLAY.
- After the Combination VCR has been in Rec Pause mode for 5 minutes, it will stop automatically to protect the tape and video head.

Selecting the Input Mode

You can select the Input Mode in either of the following ways.

- Push ▲ ▼. The display will change in the order below.

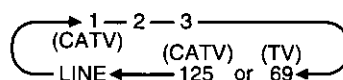

- a. Push MENU to display the menu.
- b. Push ▲ ▼ ◀ ▶ to select "TV," and then push MENU to display the SET UP TV screen.
- c. Push ▲ ▼ to select "INPUT SELECT," and then push ▶ repeatedly to select "TUNER" or "LINE."



Timer Recording

Your Combination VCR can be set up to do a recording while you are away or otherwise occupied. Up to 8 programs can be placed in memory. You can choose to record one time, daily, or weekly.

Check list before you begin.

- All connections are made (see page 5).
- Your Combination VCR is plugged in.
- The clock is set.
- The tape is long enough.
- The record tab is in place.

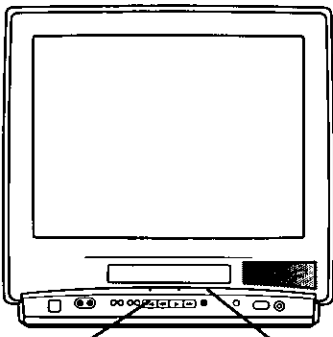

STOP/EJECT

PROGRAM TIMER Indicator

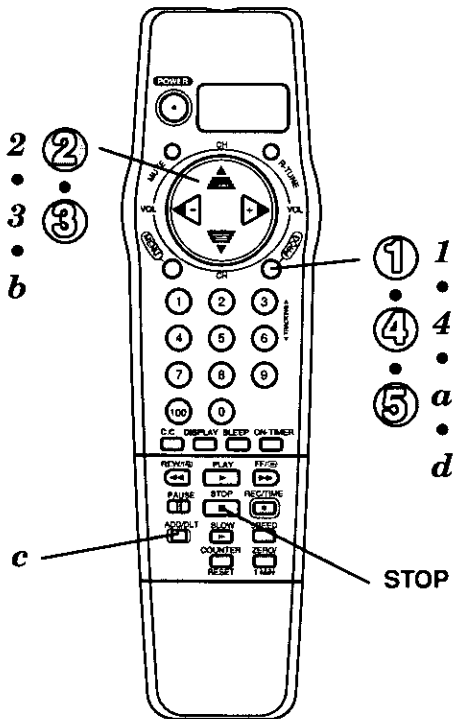

Push PROG to display the program screen.

- If a program is already in memory, push \blacktriangle \blacktriangledown repeatedly, and then \blacktriangleright to select an unused program number.

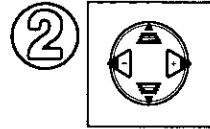
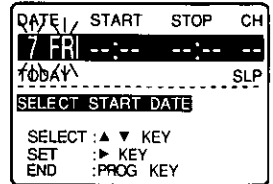

Push \blacktriangle \blacktriangledown and \blacktriangleright to select and set one of the following:

- 1~31 = One time recording
- DAILY = Same time MON ~ FRI
- WEEKLY = Same time once a week

Example

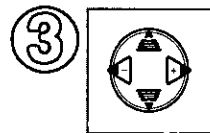
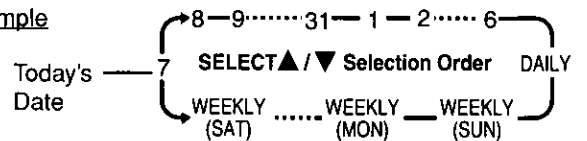

Push \blacktriangle \blacktriangledown and \blacktriangleleft \blacktriangleright to select and set each of the remaining items at right.

Remaining Items:

- START time
- STOP time
- CH(annel) number, or LINE for outside source recording
- Speed (SP, LP, SLP)

To Make Corrections

Repeatedly push \blacktriangleright or \blacktriangleleft to move the cursor to the right or left, and then make the correction.

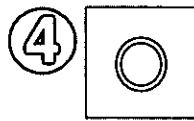

Push PROG to end the program.

- This screen appears for confirmation.

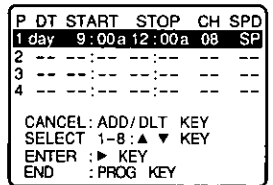

To Enter More Programs

Push \blacktriangle \blacktriangledown and \blacktriangleright to select and set a blank program number, and then repeat steps 2 and 4.



Push PROG to exit this mode and return to the normal screen.

- The PROGRAM TIMER indicator lights on the front panel.
- If you're using a cable box, make sure that it is tuned to the desired channel and the power is left on for timer recording.

Two minutes before the Timer Recording starts, "TIMER REC WILL START SOON" will appear on-screen.



- If "PLEASE PREPARE FOR TIMER REC" appears and/or the PROGRAM TIMER indicator flashes, check that a cassette with record tab is loaded and the Combination VCR is in Stop mode.
- If the start times of two programs overlap, the lower numbered program will have priority.
- If the start time for a timer recording comes up during a normal recording or One Touch Recording (page 17), the timer recording will not be performed.
- If there is a power interruption of more than one minute, the recording may not be performed or continue.
- If "INCOMPLETE" appears after all items have been set, check all entries and make necessary corrections.

Copying Your Tapes (Dubbing)

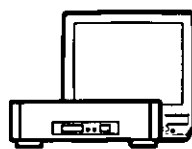

Cancel a Timer Recording: (Recording is in progress)

Hold down STOP for a few seconds to cancel the Timer Recording.

- Any future daily or weekly recordings will be performed as programmed.

Replace Program Contents: (Recording is not in progress)

- Do step 1 on previous page. All currently set programs will be displayed on-screen.

P	DT	START	STOP	CH	SPD
1	---	---	---	---	---
2	8	10:00p	12:00p	125	SLP
3	10	8:00p	9:00p	10	SP
4	SU	9:00p	10:00p	L	SLP

SELECT: 1-8: ▲ ▼ KEY
ENTER: ► KEY
END: :PROG KEY

- Push ▲ ▼ repeatedly to select the desired timer recording, and then push ► to display the settings. (See page 18.)

- Push ▲ ▼ repeatedly to select, and then push ► to enter replacement information.

DATE	START	STOP	CH
8 SAT	10:00P	11:00P	125
MIN			SLP

SELECT START DATE
SELECT: ▲ ▼ KEY
SET: ◀ ▶ KEY
END: :PROG KEY

- Push PROG twice to exit this mode and return to the normal TV screen.

Review or Clear Program Contents: (Recording is not in progress)

- Do step 1 on previous page. All currently set programs will be displayed on-screen.

P	DT	START	STOP	CH	SPD
1	Today	9:00a	12:00a	08	SP
2	8	10:00p	12:00p	125	SLP
3	10	8:00p	9:00p	10	SP
4	SU	9:00p	10:00p	L	SLP

CANCEL: ADD/HLT KEY
SELECT: 1-8: ▲ ▼ KEY
ENTER: ► KEY
END: :PROG KEY

- Push ▲ ▼ repeatedly to select the desired program number.

- Push the ADD/HLT to clear the program.

P	DT	START	STOP	CH	SPD
1	---	---	---	---	---
2	8	10:00p	12:00p	125	SLP
3	10	8:00p	9:00p	10	SP
4	SU	9:00p	10:00p	L	SLP

SELECT: 1-8: ▲ ▼ KEY
ENTER: ► KEY
END: :PROG KEY

- Push PROG to exit this mode and return to the normal TV screen.

Connections you'll need to make.

- Use this same connection for your video camera, laser disc player, video games, etc.

Recording (Editing) Combination VCR

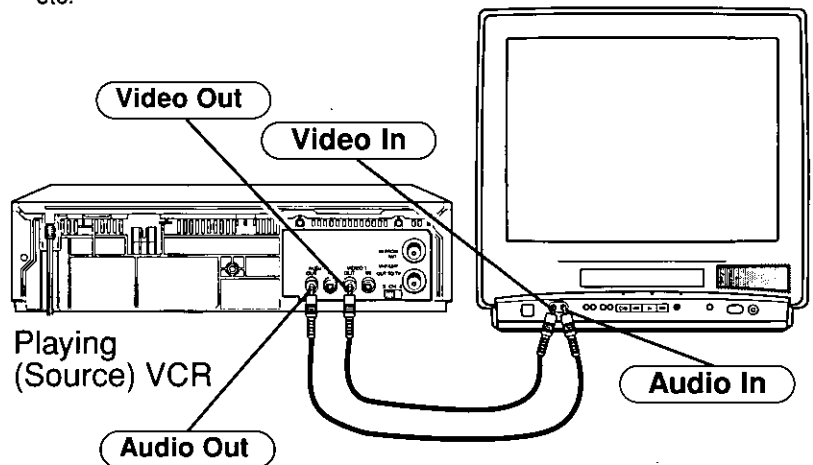

- Insert a pre-recorded tape into the Playing (source) VCR.

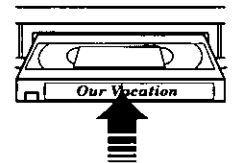

- Insert a blank tape with record tab into the Recording (editing) Combination VCR.

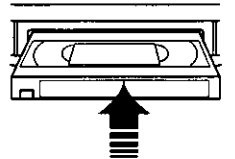

- Select "LINE" as the input on the Combination VCR.

- See "Selecting the Input Mode" section on page 17.

- Push PLAY on the VCR. Then, push PAUSE when the tape reaches the point at which you want to start copying.

- Push REC on the Combination VCR, and then immediately push PAUSE on the Combination VCR remote control.

- Push PAUSE on both units at the same time to begin copying.

You can edit out unwanted parts of the original recording by using PAUSE (on the Recording unit) while copying is in progress.

- Push STOP on both units to stop copying.

Caution:

Unauthorized exchanging and/or copying of copyrighted recordings may be copyright infringement.

✓ Check list before you begin.

- All connections are made (see page 5).
- Your Combination VCR is plugged in.

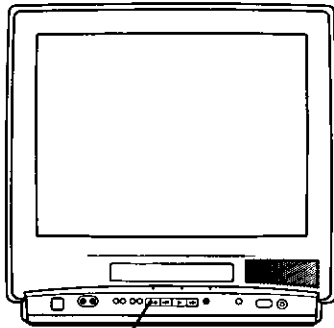

STOP/EJECT

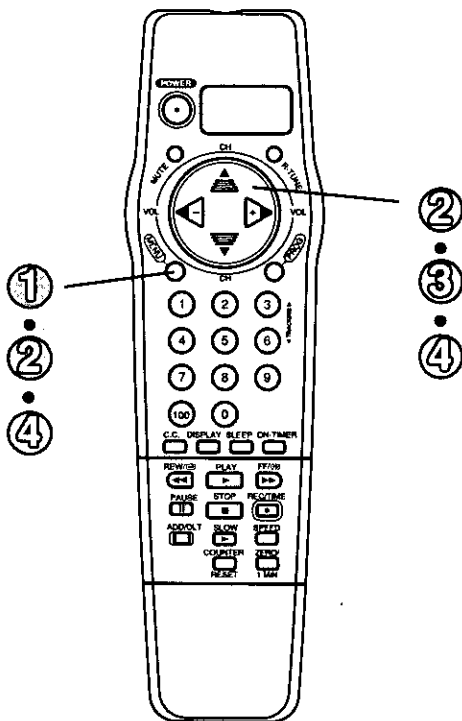

VCR Lock Feature

When activated, this feature prohibits all operations except for timer recording and tape eject. This feature is used to keep children from operating the Combination VCR.

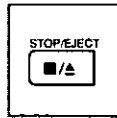

Hold down STOP/EJECT on the Combination VCR for 7 seconds during Stop or Power OFF mode.

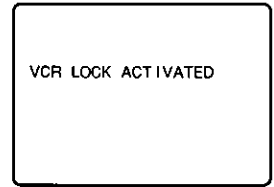

To Cancel the VCR Lock feature,



Hold down STOP/EJECT on the Combination VCR for 7 seconds again during Stop or Power OFF mode.

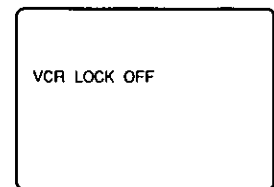

- VCR Lock mode is cancelled automatically after 24 hours as long as the clock is set.
- This feature cannot be activated or cancelled when a timer or one touch recording is in progress.

Warning Beeper Feature

When you select BEEPER ON, a short warning will sound each time an invalid entry or incomplete operation is made.

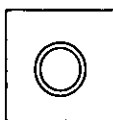

Push MENU to display the MAIN MENU.

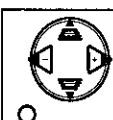
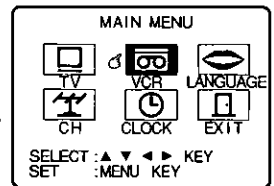

Push ▲ ▼ ◀ ▶ to select "VCR," and then push MENU to display the SET UP VCR screen.

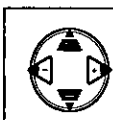

Push ▲ ▼ to select "BEEPER," and then push ▶ to select "ON" or "OFF."

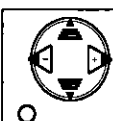
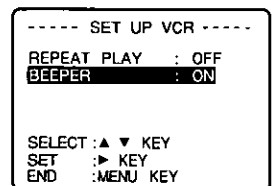

Push MENU to end, and then push ▲ ▼ ◀ ▶ to select "EXIT." Now, push MENU to exit the MAIN MENU.



Unit and Cassette Information

Erase Protection (Record Tab)

Cassettes have a record tab to ensure that recordings are not accidentally erased.

To prevent accidental erasure, break off the tab with a screwdriver.



To record again, cover the hole with cellophane tape.



Maximum Record/Playback Time

Only use tapes with the **VHS** mark in this unit.

Tape Speed Setting	Type of Video Cassette		
	T60	T120	T160
SP (Standard Play)	1 Hour	2 Hours	2 Hours 40 minutes
LP (Long Play)	2 Hours	4 Hours	5 Hours 20 minutes
SLP (Super Long Play)	3 Hours	6 Hours	8 Hours

D.S.T. (Daylight Saving Time)

Spring (First Sunday in April)

When the Combination VCR is set to DST:ON, the clock is automatically advanced one hour.

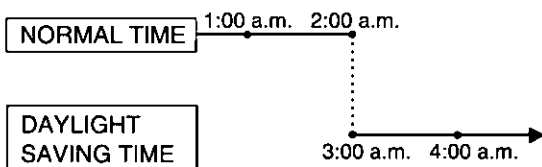

Autumn (Last Sunday in October)

When the Combination VCR is set to DST:ON, the clock is automatically turned back one hour.

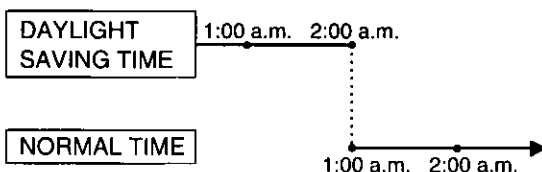

SELF-DEMO MODE

In Power ON condition, hold down PLAY/REPEAT on the Combination VCR, with no tape inserted, for 5 seconds. The demo screen appears.

To cancel: Repeat the above operation. The demo screen disappears.

Reset all Combination VCR Memory Functions

Use when moving the Combination VCR to a new location, or if a mistake was made in the One Time Setup section.

- Make sure a tape is not inserted in the Combination VCR.
- 1) Push POWER to turn the Combination VCR on.
 - 2) Hold down both the PLAY and REWIND buttons on the Combination VCR for more than 5 seconds.
 - The power will shut off.
 - 3) Turn the power back on and perform the One Time Setup section on page 8.

Head Cleaning

Your Combination VCR will not normally require head cleaning, however the heads may become clogged when playing an old or damaged tape.

Video Heads Sensor System

If head cleaning becomes necessary, the Combination VCR will display the screen at right during playback of a recorded signal. To exit this screen, push PLAY on the remote control or Combination VCR.

VIDEO HEADS MAY NEED CLEANING
PLEASE INSERT HEAD CLEANING CASSETTE OR REFER TO MANUAL

END:PLAY KEY

- Use "dry" type head cleaning cassette* only.
- Be sure to follow the cleaning tape instructions carefully. Excessive use of a cleaning cassette can shorten head life.
- If using a head cleaning cassette does not solve the problem, contact your nearest Factory Service Center or authorized Service Center. (See page 23.)

*Cleaning cassette part No. NV-TCL30PT is recommended.

Product Specifications

Display

Picture Tube: 25 inch measured diagonal 110° deflection Picture Tube

VCR

Video Recording System: 2 rotary heads helical scanning system
 Audio Track: 1 track
 Tuner:
 Broadcast Channels: VHF 2~13, UHF 14~69
 CATV Channels: Midband A through I (14~22)
 Superband J through W (23~36)
 Hyperband AA~EEE (37~64)
 Lowband A-5~A-1 (95~99)
 Special CATV channel 5A (01)
 Ultraband 65~94, 100~125

General

Power Source: 120V AC, 60 Hz
 Power Consumption: Approx. 149 watts (Power on)
 Approx. 5 watts (Power off)
 Television System: EIA Standard NTSC color
 Speaker: 1 piece
 Operating Temperature: 41°F~104°F (5°C~40°C)
 Operating Humidity: 10%~75%
 Weight: 73 lbs. (33 Kg)
 Dimensions: 24-15/16" (W) X 23-1/8" (H) X 18-1/4" (D)
 634 (W) X 588 (H) X 464 (D) mm

Note: Designs and specifications are subject to change without notice.



Before Requesting Service

Check the following points once again if you are having trouble with your Combination VCR.

Power	Correction
No power...	<ul style="list-style-type: none"> • Completely insert the Power Plug into an AC wall outlet. • Set the POWER button to ON.
Monitor	Correction
No picture or sound...	<ul style="list-style-type: none"> • Make sure your antenna or cable system is connected to the Combination VCR. (P. 5) • Check that the power plug is completely plugged into an AC outlet. • Check that the POWER button is set to on.
Poor picture with normal sound...	<ul style="list-style-type: none"> • Adjust the BRIGHT, SHARPNESS, and PICTURE controls in the SET UP TV menu. (P. 12)
Poor sound with normal picture...	<ul style="list-style-type: none"> • Adjust the VOLUME control. (P. 11)
Poor TV reception...	<ul style="list-style-type: none"> • Adjust the SHARPNESS and PICTURE controls in the SET UP TV menu. (P. 12)
No color or poor color...	<ul style="list-style-type: none"> • Adjust the TINT and COLOR controls in the SET UP TV menu. (P. 12)
Ghost (multiple) images...	<ul style="list-style-type: none"> • Install a directional antenna.
TV programs cannot be watched...	<ul style="list-style-type: none"> • Make sure that the channel being received is in the Combination VCR's memory. (P. 8)
VCR	Correction
TV program cannot be recorded...	<ul style="list-style-type: none"> • Make sure your antenna or cable system is connected to the Combination VCR. (P. 5) • Make sure that the record tab is intact on the cassette. (P. 21)
Timer recording cannot be performed...	<ul style="list-style-type: none"> • Set the recording Start/Stop time correctly. (P. 18-19) • Timer recording may not be performed or continued if a power interruption of more than 1 minute occurs before or during a Timer Recording, even if power resumes thereafter.
No playback picture, or the playback picture is noisy or contains streaks...	<ul style="list-style-type: none"> • Adjust the TRACKING control in either direction. (P. 15)
VCR cannot be controlled...	<ul style="list-style-type: none"> • Make sure that VCR LOCK is set to off. (P. 20)
Remote Control	Correction
Combination VCR cannot be remote controlled...	<ul style="list-style-type: none"> • Aim the Remote Control directly at the remote sensor on the Combination VCR. (P. 7) • Avoid all obstacles which may interfere with the signal path. • Inspect the remote batteries for possible replacement. (P. 4) • Make sure that VCR LOCK is set to off. (P. 20) • Exposing the Combination VCR remote sensor to direct fluorescent or outdoor light may cause signal interference.
Miscellaneous	Correction
Video cassette cannot be inserted...	<ul style="list-style-type: none"> • Insert cassette with window side up and the record tab facing you.
Video cassette cannot be removed...	<ul style="list-style-type: none"> • Check that the power plug is completely plugged into an AC outlet.
Eject does not function or insertion cannot be done...	<ul style="list-style-type: none"> • Turn the POWER off and then on, and try ejecting or inserting the tape again.
Video cassette ejects when a recording is started, or the power is turned off for timer recording...	<ul style="list-style-type: none"> • Make sure the record tab is intact on the cassette. (P. 21)
In stop mode, the VCR motor (CYLINDER) continues to rotate...	<ul style="list-style-type: none"> • To enable the quick play mechanism, the VCR cylinder will rotate for about 5 minutes. This reduces response time from Stop to Play mode and from Play to Rewind Search mode.
VCR cannot be controlled...	<ul style="list-style-type: none"> • Make sure that VCR LOCK is set to off. (P. 20)

If you cannot resolve your problem, please call the Customer Satisfaction Center for product assistance at 201-348-9090.

To locate an authorized servicenter call toll free 1-800-545-2672.

Service Center List

PRODUCT INFORMATION • OPERATION ASSISTANCE • LITERATURE REQUESTS • DEALER LOCATIONS

Customer Service Center 2F-3, One Panasonic Way, Secaucus, NJ 07094 (Headquarters)
201-348-9090 (9:00am-8:00pm Monday-Friday, EST)

ACCESSORY PURCHASES

Panasonic Services Company 20421 84th Avenue South Kent, WA 98032
(6 am to 6 pm Monday-Friday ; 6 am to 10:30 am Saturday ; PST)
(Visa, Mastercard, Discover card, American Express, Check)

AUTHORIZED SERVICENTERS • PARTS DISTRIBUTOR LOCATIONS

To locate an independent authorized servicer or parts distributor in your area,
within the USA dial toll free **1-800-545-2672**, 24 hours a day, 7 days a week.

PRODUCT REPAIRS

Factory Servicenters

CALIFORNIA

6550 Katella Avenue
Cypress, CA 90630
Phone (714) 373-7426
Fax (714) 894-8534

800 Dubuque Avenue
S. San Francisco, CA 94080
Phone (415) 871-6373
Fax (415) 871-6840

20201 Sherman Way
Suite 102
Canoga Park, CA 91306
Phone (818) 709-1775
Fax (818) 709-2165

3878 Ruffin Road
Suite A
San Diego, CA 92123
Phone (619) 560-9200
Fax (619) 560-1831

COLORADO

1640 South Abilene Suite D
Aurora, CO 80012
Phone (303) 752-2024
Fax (303) 752-0610

FLORIDA

3700 North 29th Avenue
Suite 102
Hollywood, FL 33020
Phone (954) 925-2880
Fax (954) 925-5224

GEORGIA

8655 Roswell Road
Suite 100
Atlanta, GA 30350
Phone (770) 518-6300
Fax (770) 518-6306

HAWAII

99-859 Iwaiwa Street
Aiea, Hawaii 96701
Phone (808) 488-4369
Fax (808) 486-4369

ILLINOIS

1703 North Randall Road *
Elgin, IL 60123
12:30 to 4:30, Mon-Fri
Phone (847) 468-5464
Fax (847) 468-5465

9060 Golf Road
Niles, IL 60714
Phone (847) 608-1010
Fax (847) 299-1710

MARYLAND

62 Mountain Road
Glen Burnie, MD 21061
Phone (800) 973-4071
Fax (410) 760-3779

MASSACHUSETTS

60 Glacier Drive, Suite G
Westwood, MA 02090
Phone (617) 329-4280
Fax (617) 329-0586

* pick up/drop-off only

MICHIGAN

37048 Van Dyke Avenue
Sterling Heights, MI 48312
Phone (810) 939-2060
Fax (810) 939-2638

MINNESOTA

7850-12th Avenue South
Airport Business Center
Bloomington, MN 55425
Phone (612) 854-8624
Fax (612) 854-2089

OHIO

2236 Waycross Road
Cincinnati, OH 45240
Phone (513) 851-4180
Fax (513) 851-8443

PENNSYLVANIA

2221 Cabot Boulevard West
Suite B
Langhorne, Pa 19047
Phone (215) 741-0661
Fax (215) 741-0521
Chartiers Valley Shopping
Center
1025 Washington Pike
Bridgeville, PA 15017
Phone (412) 257-4522
Fax (412) 257-4650

TENNESSEE

919-8th Avenue South
Nashville, TN 37203
Phone (615) 244-4434
Fax (615) 244-6713

TEXAS

7482 Harwin Drive
Houston, TX 77036
Phone (713) 781-1528
Fax (713) 781-0643

13615 Welch Road
Suite 101
Farmers Branch, TX 75244
Phone (972) 385-1975
Fax (972) 960-7626

WASHINGTON

20425-84th Avenue South
Kent, WA 98032
Phone (206) 872-7922
Fax (206) 872-0918

Service in Puerto Rico

**Matsushita Electric
of Puerto Rico, Inc.
Panasonic Sales Company/
Factory Servicer**
Ave. 65 de Infantería, Km. 9.5
San Gabriel Industrial Park
Carolina, Puerto Rico 00985
Phone (787) 750-4300
Fax (787) 768-2910

REPAIR INQUIRIES

Regional Customer Care Department

EAST (PCE)

2221 Cabot Boulevard West
Suite A
Langhorne, PA 19047
Phone (215) 741-0676
Fax (215) 750-6492

Covers:
CT, DE, ME, MD, MA, NH, NJ,
NY, PA, RI, VT, VA, DC, WV

EAST (PCE)

1225 Northbrook Parkway
Suite 2-390
Suwanee, GA 30174
Phone (770) 338-6860
Fax (770) 338-6548

Covers:
AL, FL, GA, MS, NC, SC, TN

CENTRAL (PCC)

1707 North Randall Road
Elgin, IL 60123
Phone (847) 468-5530
Fax (847) 468-5528

Covers:
AR, IL, IN, IA, KS, KY, LA,
MI, MN, MO, NE, ND, OK,
SD, TX, WI, OH

WEST (PCW)

6550 Katella Avenue
Cypress, CA 90630
Phone (714) 373-7440
Fax (714) 373-7447

Covers:
AK, AZ, CA, CO, ID, MT, NV,
NM, OR, UT, WA, WY, HI

As of April '97

Conexión de la antena externa

Desenganche la antena del televisor o de la videograbadora que tuviera anteriormente y conéctela a la parte trasera del registrador Combinación de VCR/TV, como se muestra en el diagrama. Si el sistema de su antena tiene conductores UHF y VHF separados, usted necesita un mezclador de banda UHF/VHF (no viene con el equipo).

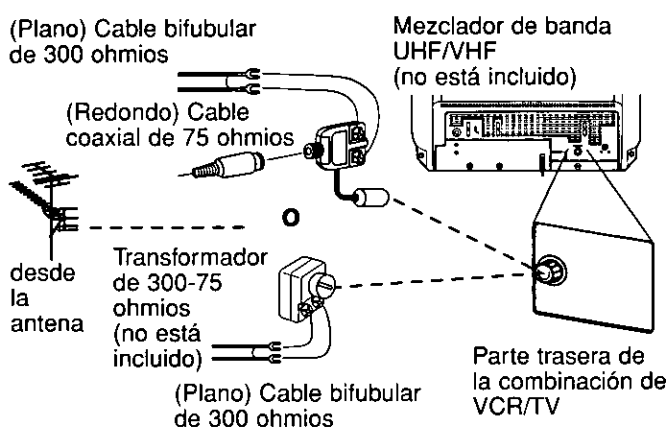

Conexiones de TV por cable

(A) Sin la caja convertidora/decodificadora

Con esta conexión usted podrá utilizar su control remoto de la combinación de VCR/TV para seleccionar los canales que desea ver y seleccionar canales no codificados para su grabación programada. Esta conexión no permite ver ni grabar canales codificados.

(B) Con una caja convertidora/decodificadora

Con esta conexión, usted podrá grabar y ver cualquier canal, incluyendo los canales codificados. Sin embargo, la selección de canales se debe efectuar en la caja convertidora de TV por cable que suministra esta empresa. La grabación programada está limitada a un canal cada vez, y sólo se podrá ver el canal que esté grabando.

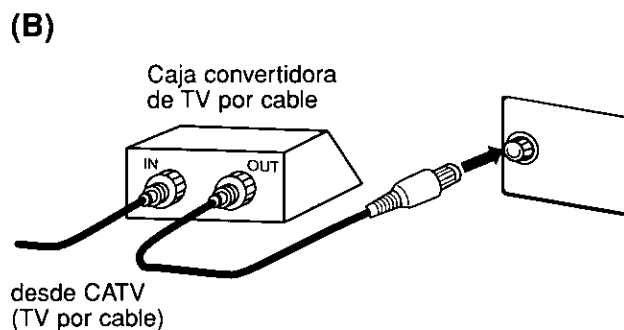
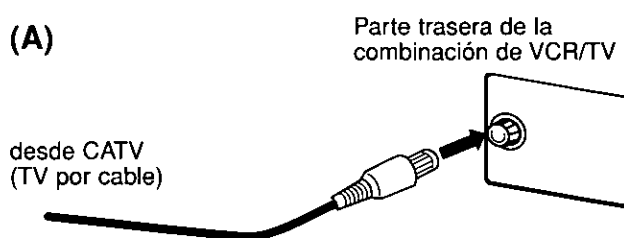

Para ver y grabar un canal codificado/no codificado



Sintonice el canal del Registrador de la combinación de VCR/TV en el canal de salida de la caja convertidora de televisión por cable (por ejemplo el canal 3).

Después, seleccione en la caja convertidora de TV por cable el canal que se quiera ver o grabar.

Para fijar el idioma, canal y reloj

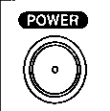
Al encender la combinación de VCR/TV por primera vez, aparecerán las pantallas para fijar automáticamente los canales y el reloj.

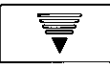
1  Oprimir POWER para encender el aparato.

2   o  para la exhibición de la pantalla en inglés, español o francés.

SELECT LANGUAGE
PUSH CH ▲ :English
PULSE CH ▼ :Español
APP. VOL + :Français

3  **Importante: si está usando una caja de TV por cable, encienda la caja y sintonice al canal PBS de su zona.**

FIJACION AUTO. (CA/RELOJ)
CONECTE EL CABLE DE LA ANTENA Y SI ESTA USANDO UNA CAJA DE TV POR CABLE SINTONICE AL CANAL PBS DE SU LOCAL LUEGO...
POR FAVOR OPRIMIR CH UP

Oprimir ▲ para iniciar la fijación de los canales y el reloj.

Las siguientes informaciones aparecerán seguidamente:

- AUTOPROGRAMACION EN PROCESO
- AUTOPROGRAMACION COMPLETO
- FIJACION AUTOMATICA DEL RELOJ EN PROCESO

Caso 1

7/28/1997 LUN 12:00PM
HORA VERANIEGA: ACT
CANAL FIJADO : CA 10
FIJACION AUTOMATICA
COMPLETO
TERMINAR : PULSE CH UP

Caso 2

FIJACION AUTOMATICA DEL
RELOJ ES INCOMPLETO
PULSE MENU
PARA FIJAR EL RELOJ

4 **Caso 1** Comprobar si la hora está fijada para terminar la fijación.

Si la hora y la hora veraniega es incorrecta,

Raras veces, en caso de que ud. vive cerca de dos zonas con hora diferente, el aparato puede elegir un canal PBS con diferente hora de su zona. En este caso, haga los siguientes pasos:

- Tome nota del canal que está fijado en la pantalla y salga desde este modo oprimiendo el botón ▲.
- Anule este canal desde los canales memorizados en la combinación de VCR/TV.
- Oprima el botón MENU para que aparezca la pantalla del MENU.
- Oprima ▲ ▼ ◀ ▶ para elegir "RELOJ" y luego oprima MENU para que aparezca la pantalla de FIJACION DEL RELOJ.
 - Si ud. esta usando una caja de TV por cable y tiene muchos canales PBS, sintonice la caja de TV por cable a un canal PBS diferente e intente la fijación automática otravez usando el menú.
- Oprimir ▲ ▼ para elegir "FIJACION AUTOMATICA", luego oprimir ▶ para fijar y oprimir ▲ para iniciar.

- Por cualquier razón, si ha cambiado la hora manualmente, no funcionará la corrección automática de la hora.
- La fijación automática del reloj efectuará cada día al apagar la combinación de VCR/TV por primera vez. Si ud. usa una caja de TV por cable y desea efectuar la fijación automática del reloj, la caja de TV por cable debe permanecer encendido y sintonizado el canal PBS cuando se apaga la combinación de VCR/TV.

Caso 2 Si aparece FIJACION AUTOMATICA DEL RELOJ ES INCOMPLETO, por favor fije el reloj manualmente.

- Oprimir MENU para que aparezca la pantalla de la fijación del reloj.
- Oprimir ▲ ▼ para elegir y oprimir ▶ para fijar el mes, la fecha, el año, la hora y la hora veraniega.

Para hacer correcciones,

Oprimir ◀ ▶ repetidamente para retroceder o avanzar hasta el paso que desea corregir.

- Oprimir MENU para iniciar a funcionar el reloj. Luego oprimir ▲ ▼ ◀ ▶ para elegir "SALIR" y oprimir MENU para salir de la pantalla del MENU PRINCIPAL.

Para fijar o fijar de nuevo el reloj

En caso de que el reloj es incorrecto o ha ocurrido un corte eléctrico.

- Oprima MENU para que parezca el MENU PRINCIPAL.
- Oprima ▲ ▼ ◀ ▶ para elegir "RELOJ". Luego, oprima MENU para que aparezca la pantalla de la FIJACION DEL RELOJ.
- Oprima ▲ ▼ para elegir "FIJACION MANUAL", y luego ▶ para que aparezca la pantalla de la FIJACION DEL RELOJ.
- Por favor continúe con los pasos b y c de la instrucción anterior (Caso 2).

FIJAR RELOJ ----
--/--/---- :--:--
--\-- VERANO:ACT
ELEGIR MES
ELEGIR:▲▼
FIJAR :▶
TERMINAR:MENU

Operaciones para ver la TV

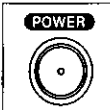
1  Oprimir POWER para encender la combinación de VCR/TV.

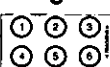
2   o usando la teclas numéricas.

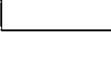
3   Oprimir ◀ ▶ para ajustar el nivel del volumen.

24 (|||||).....

Encendedor automático con alarma

La combinación de VCR/TV se puede fijar para que se encienda automáticamente en uno de los dos modos (TV o reproducción). Ud. también puede combinar con un alarma despertador de un minuto.

1  Oprimir ON TIMER para que aparezca la pantalla del encendedor automático.

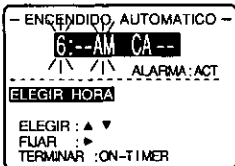

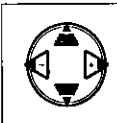
2  Oprimir ▲ ▼ para elegir y oprimir ► para fijar la hora del encendedor automático y luego para elegir el modo (TV o reproducción).

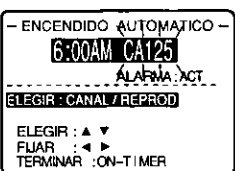

- Asegúrese de que una cinta de video esté introducido en la combinación de VCR/TV, si ha elegido la reproducción de la videograbadora.

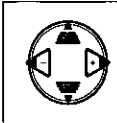
3  Oprimir ▲ ▼ para elegir la fijación del alarma.

Si ha elegido "ACT", sonará un alarma por un minuto o hasta cancelar oprimiendo cualquiera de las teclas del control remoto. Cuando se apaga el alarma, sonará el sonido del modo que ha elegido.

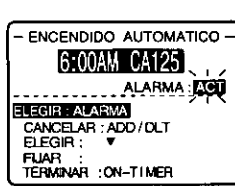

Para hacer correcciones, use ▲ ▼ y ◀ ▶ para retroceder o avanzar como se necesita.

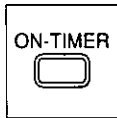
4  Oprimir ON TIMER para fijar la función del encendedor automático. Esta pantalla aparecerá cerca de 5 segundos.

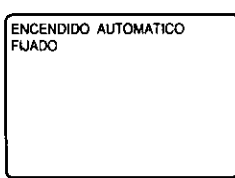

• El indicador de ON TIMER (encendedor automático) se encenderá en el panel delantero.

Para cancelar, oprima ON-TIMER para que aparezca de nuevo la pantalla del paso 3. Luego, oprima ADD/DLT para anular la hora ("6" destellará). Ahora, oprima ON-TIMER para terminar. "ENCENDIDO AUTOMATICO ANULADO" aparecerá unos segundos en la pantalla.

60 minutos luego de que la combinación de VCR/TV se ha encendido automáticamente, éste se apagará por sí mismo si no se ha oprimido ningún botón del control remoto o del aparato.

Fijación del temporizador para dormir

La combinación de VCR/TV se puede fijar para que se apague automáticamente.

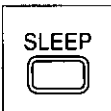

SLEEP  Oprimir SLEEP para que aparezca el tiempo de la fijación.

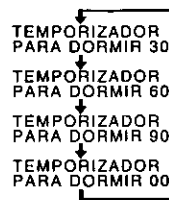
- Si ud. oprime el botón DISPLAY con el temporizador para dormir fijado, aparecerá en la pantalla el tiempo que sobra para apagarse.

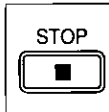

Para cancelar, oprimir SLEEP sucesivamente hasta que aparezca "TEMPORIZADOR PARA DORMIR 00".

Operaciones básicas para la reproducción

- 1** Introducir una cinta.
- La combinación de VCR/TV se enciende automáticamente.
- 2**  Oprimir PLAY en el control remoto o combinación de VCR/TV para comenzar a reproducir.
- Si la cinta no tiene la lengüeta para evitar el borrado, la combinación de VCR/TV comienza a reproducir automáticamente.
- 3**  Oprimir STOP en el control remoto o combinación de VCR/TV para parar la reproducción.
- 4**  Oprimir STOP/EJECT en la combinación de VCR/TV para expulsar la cinta.
- Usted puede expulsar la cinta cuando el aparato está encendido o apagado.

Para buscar una escena en particular durante la reproducción

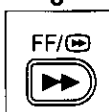
-  Oprimir REW o FF durante la reproducción para buscar una escena.
- La velocidad de búsqueda es a 27 veces más rápida que la velocidad normal para el mode SLP.
- o
- 

Operaciones básicas para la grabación

1 Introducir una cinta de video que tenga la lengüeta para evitar el borrado.

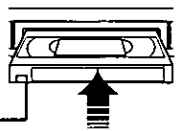

- la combinación de VCR/TV se enciende automáticamente.

2 Oprimir ▲ ▼ o las teclas numéricas para elegir el canal.

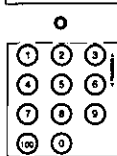

- U oprimir ▲ ▼ de la combinación de VCR/TV.
- Para grabar desde una fuente externa, oprimir ▲ ▼ y elija LINEA.

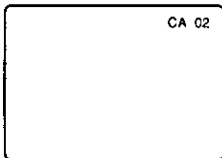

3 Oprimir SPEED hasta que aparezca la velocidad deseada.

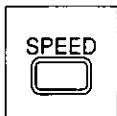

- SP = reproducción normal
- LP = reproducción larga
- SLP = reproducción super larga

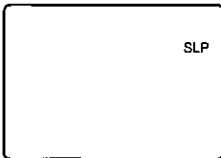

4 Oprimir REC/TIME del control remoto para empezar a grabar.

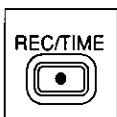

- U oprimir REC/TIME de la combinación de VCR/TV.
- Oprimir PAUSE para hacer una pausa en la grabación de un toque.

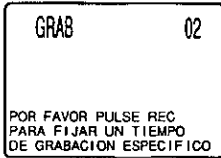

Grabación de un toque (OTR)

La combinación de VCR/TV se puede fijar para parar la grabación a una hora fijada anteriormente.

En el paso 4, oprimir repetidamente REC/TIME para fijar el tiempo de grabación.

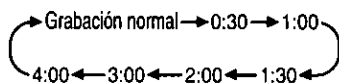

- La luz indicador de la grabación programada (TIMER) se enciende en el panel delantero.

5 Oprimir STOP para parar la grabación.

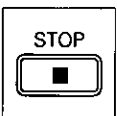

- U oprimir STOP/EJECT de la combinación de VCR/TV.

Grabación con temporizador

1 Oprimir PROG para exhibir la pantalla de la programación.

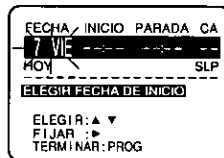
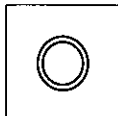

- Si ya existe una programación memorizada, oprima ▲ ▼ y ▶ para elegir un número sin programación.

2 Oprimir ▲ ▼ y ▶ para elegir y fijar uno de los siguientes:

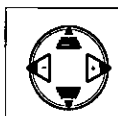

- 1~31 = Grabación de una sola vez
- DIARIO = A una misma hora LUN ~VIE
- SEMANTAL = Una vez a la semana a una misma hora

Ejemplo

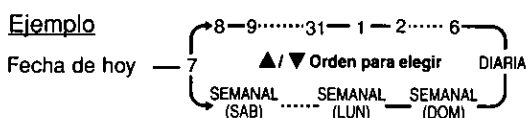

3 Oprimir ▲ ▼ y ◀ ▶ para elegir y fijar las siguientes fijaciones.

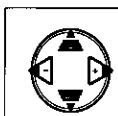

- Fijaciones:**
- Hora de inicio
 - Hora de parada
 - Canal o LINEA para una fuente externa
 - Velocidad de la cinta (SP, LP, SLP)

Para hacer correcciones

Oprimir ▶ sucesivamente para avanzar u ◀ para retroceder hasta el paso que desea corregir.

4 Oprimir PROG para terminar la programación.

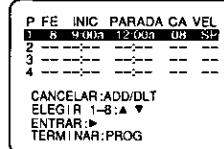
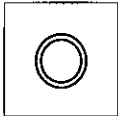

Para hacer más programaciones

Oprimir ▲ ▼ y ▶ para elegir y fijar un número de programa en blanco y luego repita los pasos 2 y 4.

5 Oprimir PROG para salir desde este modo y volver a la pantalla normal.

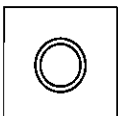

- La luz indicador de la grabación programada (TIMER) se enciende en el panel delantero.
- Si ud. está usando una caja de TV por cable, asegúrese de que esté sintonizado el canal deseado y que esté encendido para la grabación con temporizador.

Dos minutos antes de empezar la grabación, "GRABACION PROGRAMADA INICIARA ENSEGUIDA" aparecerá en la pantalla.

Warranty

Panasonic Consumer Electronics
Company, Division of Matsushita
Electric Corporation of America,
One Panasonic Way
Secaucus, New Jersey 07094

Panasonic Sales Company,
Division of Matsushita Electric of Puerto Rico, Inc.
AVE. 65 de Infanteria, Km. 9.5
San Gabriel Industrial Park
Carolina, Puerto Rico 00985

QUASAR Video Products Limited Warranty

Panasonic Consumer Electronics Company or Panasonic Sales Company (collectively referred to as "the Warrantor") will repair this product with new or refurbished parts, free of charge, in the USA or Puerto Rico, in the event of a defect in materials or workmanship as follows (all time periods commence from the date of the original purchase):

<u>PRODUCT</u>	<u>PARTS</u>	<u>LABOR</u>
CAMCORDER	ONE (1) YEAR, EXCEPT CCD IMAGE SENSOR CCD IMAGE SENSOR - SIX (6) MONTHS	NINETY (90) DAYS NINETY (90) DAYS
VCR	ONE (1) YEAR	NINETY (90) DAYS
A/V MIXER	ONE (1) YEAR	NINETY (90) DAYS
MONITOR-VCR	ONE (1) YEAR, EXCEPT CRT CRT - TWO (2) YEARS	NINETY (90) DAYS CRT - NINETY (90) DAYS CUSTOMER PAYS ALL LABOR CHARGES AFTER 90 DAYS

Monitor-VCR In-home or carry-in Service: 19" (diagonal) CRT / LCD and Larger
Monitor-VCR Carry-in Service: 18" (diagonal) CRT / LCD and smaller

Batteries (if included) - New rechargeable batteries in exchange for defective rechargeable batteries for ten (10) days. Non-rechargeable batteries are not warranted.

Tape (if included) - New video cassette tape in exchange for a defective video cassette tape for five (5) days.

In-home, carry-in or mail-in service, as applicable, in the USA can be obtained during the warranty period by contacting a Panasonic Services Company (PASC) Factory Servicenter listed in the Service Directory. Or call toll free 1-800-545-2672, to locate an authorized PASC Servicenter. Carry-in or mail-in service in Puerto Rico can be obtained during the warranty period by calling the Panasonic Sales Company telephone number listed in the Servicenter Directory.

This warranty is extended only to the original purchaser. A purchase receipt or other proof of the date of the original purchase is required before warranty service is rendered.

This warranty only covers failures due to defects in materials and workmanship which occur during normal use and does not cover normal maintenance, including, but not limited to, video and audio head cleaning. The warranty does not cover damage which occurs in shipment, or failures which are caused by products not supplied by the warrantor, or failures which result from accident, misuse, abuse, neglect, mishandling, misapplication, alteration, modification, faulty installation, set-up adjustments, improper antenna, inadequate signal pickup, maladjustment of consumer controls, improper operation, power line surge, improper voltage supply, lightning damage, commercial use such as hotel, office, restaurant, or other business or rental use of the product, or service by anyone other than a PASC Factory Servicenter or a PASC authorized Servicenter, or damage that is attributable to acts of God.

LIMITS AND EXCLUSIONS

There are no express warranties except as listed above.

THE WARRANTOR SHALL NOT BE LIABLE FOR INCIDENTAL OR CONSEQUENTIAL DAMAGES (INCLUDING, WITHOUT LIMITATION, DAMAGE TO TAPES) RESULTING FROM THE USE OF THIS PRODUCTS, OR ARISING OUT OF ANY BREACH OF THE WARRANTY. ALL EXPRESS AND IMPLIED WARRANTIES, INCLUDING THE WARRANTIES OF MERCHANTABILITY AND FITNESS FOR PARTICULAR PURPOSE, ARE LIMITED TO THE APPLICABLE WARRANTY PERIOD SET FORTH ABOVE.

Some states do not allow the exclusion or limitation of incidental or consequential damages, or limitations on how long an implied warranty lasts, so the above exclusions or limitations may not apply to you.

This warranty gives you specific legal rights and you may also have other rights which vary from state to state.

If a problem with this product develops during or after the warranty period, you may contact your dealer or Servicenter. If the problem is not handled to your satisfaction, then write to the Customer Satisfaction Center at the Panasonic Consumer Electronics Company address above.

SERVICE CALLS WHICH DO NOT INVOLVE DEFECTIVE MATERIALS OR WORKMANSHIP AS DETERMINED BY THE WARRANTOR, IN ITS SOLE DISCRETION, ARE NOT COVERED. COSTS OF SUCH SERVICE CALLS ARE THE RESPONSIBILITY OF THE PURCHASER.

warvid 2/11/97

**Panasonic Consumer Electronics
Company, Division of Matsushita
Electric Corporation of America**
One Panasonic way Secaucus,
New Jersey 07094

Printed in U.S.A.
VQTS3393 (A)



Free Manuals Download Website

<http://myh66.com>

<http://usermanuals.us>

<http://www.somanuals.com>

<http://www.4manuals.cc>

<http://www.manual-lib.com>

<http://www.404manual.com>

<http://www.luxmanual.com>

<http://aubethermostatmanual.com>

Golf course search by state

<http://golfingnear.com>

Email search by domain

<http://emailbydomain.com>

Auto manuals search

<http://auto.somanuals.com>

TV manuals search

<http://tv.somanuals.com>