

ARC-101

ATM Rate and Media Converter Installation and Operation Manual

Notice

This manual contains information that is proprietary to RAD Data Communications. No part of this publication may be reproduced in any form whatsoever without prior written approval by RAD Data Communications.

No representation or warranties for fitness for any purpose other than what is specifically mentioned in this manual is made either by RAD Data Communications or its agents.

For further information contact RAD Data Communications at the address below or contact your local distributor.

RAD data communications Headquarters	RAD data communications US East	RAD data communications US West
12 Hanechoshet Street Tel Aviv 69710 Israel Tel: 972-3-6458181 Fax: 972-3-6498250 E-mail: rad@ rad.co.il	900 Corporate Drive Mahwah, NJ 07430 USA Tel: (201) 529-1100 Fax: (201) 529-5777 E-mail: market@radusa.com	3631 South Harbor Boulevard Suite 250 Santa Ana, CA 92704 Tel: (714) 850-0555 Fax: (714) 850-1555

Warranty

This RAD product is warranted against defects in material and workmanship for a period of one year from date of shipment. During the warranty period, RAD will, at its option, either repair or replace products which prove to be defective. For warranty service or repair, this product must be returned to a service facility designated by RAD. Buyer shall prepay shipping charges to RAD and RAD shall pay shipping charges to return the product to Buyer. However, Buyer shall pay all shipping charges, duties and taxes for products returned to RAD from another country.

Limitation of Warranty

The foregoing warranty shall not apply to defects resulting from improper or inadequate maintenance by Buyer, Buyer-supplied firmware or interfacing, unauthorized modification or misuse, operation outside of the environmental specifications for the product, or improper site preparation or maintenance.

Exclusive Remedies

The remedies provided herein are the Buyer's sole and exclusive remedies. RAD shall not be liable for any direct, indirect special, incidental, or consequential damages, whether based on contract, tort, or any legal theory.

Safety Warnings



The exclamation point within a triangle is intended to warn the operator or service personnel of operation and maintenance factors relating to the product and its operating environment which could pose a safety hazard.

Always observe standard safety precautions during installation, operation and maintenance of this product. Only a qualified and authorized service personnel should carry out adjustment, maintenance or repairs to this instrument. No adjustment, maintenance or repairs should be performed by either the operator or the user.

Telecommunication Safety

The safety status of each of the ports on the ARC-101 is declared according to EN 41003 and is detailed in the table below:

Safety Status	Ports
SELV*	ATM, VTP/155, CX/BBC/155, T3, E3
TNV** operating within limits of SELV	E1

* SELV = Safety Extra-Low Voltage

** TNV = Telecommunications Network Voltage

Regulatory Information

FCC-15 User Information

This equipment has been tested and found to comply with the limits of the Class A digital device, pursuant to Part 15 of the FCC rules. These limits are designed to provide reasonable protection against harmful interference when the equipment is operated in a commercial environment. This equipment generates, uses and can radiate radio frequency energy and, if not installed and used in accordance with the instruction manual, may cause harmful interference to the radio communications. Operation of this equipment in a residential area is likely to cause harmful interference in which case the user will be required to correct the interference at his own expense.

Warning per EN 55022

This is Class A product. In a domestic environment, this product may cause radio interference, in which case the user may be required to take adequate measures.

Declaration of Conformity

Manufacturer's Name: RAD Data Communications Ltd.

Manufacturer's Address: 12 Hanechoshet St.
Tel Aviv 69710
Israel

declares that the product:

Product Name: **ARC-101**

Conforms to the following standard(s) or other normative document(s):

EMC:	EN 55022 (1994)	Limits and methods of measurement of radio disturbance characteristics of information technology equipment.
	EN 50082-1 (1992)	Electromagnetic compatibility - Generic immunity standards for residential, commercial and light industry.
Safety:	EN 60950 (1992/93)	Safety of information technology equipment, including electrical business equipment.

Supplementary Information:

The product herewith complies with the requirements of the EMC Directive 89/336/EEC and the Low Voltage Directive 73/23/EEC. The product was tested in a typical configuration.

Tel Aviv, January 23rd, 1997

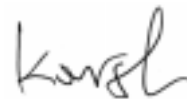

Haim Karshen
VP Quality

European Contact: RAD Data Communications GmbH, Lyoner Strasse 14, 60528 Frankfurt am Main, Germany

Contents

CHAPTER 1 – INTRODUCTION

1.1 General Description	1-1
1.2 ARC-101 Features	1-2
Interfaces Supported	1-2
Rate Adaptation	1-2
Easy Migration	1-2
User Management and Monitoring	1-2
Indicators.....	1-2
Compatibility	1-2
Traffic Management	1-3
Loopback Mode.....	1-3
1.3 Specifications	1-4
Data Rate.....	1-4
Indicators.....	1-4
Control Port.....	1-4
Power	1-4
Physical	1-4
Environment	1-4
Ordering.....	1-5

CHAPTER 2 – INSTALLATION

2.1 General	2-1
2.2 Unpacking	2-1
2.3 Site Requirements	2-2
Power	2-2
Front and Rear Panel Clearance	2-2
Ambient Requirements.....	2-2
2.4 Rack Mounting Instructions	2-2
Installation of a Single Unit.....	2-2
Installation of Two Units.....	2-3
2.5 Cable Connections	2-3
ATM Connection	2-3
Control Port Connection	2-3
AC Power Connection.....	2-5
Grounding	2-5
2.6 ARC-101 Modules	2-6
Module Characteristics.....	2-6
Inserting and Removing Modules.....	2-11

Jumper Settings for E1 and E1/LTU2-12
Jumper Settings for T32-13

CHAPTER 3 – OPERATION

3.1 Operating Procedure3-2
Turning on the ARC-1013-2
Normal Operation3-2
Turning off the ARC-1013-2
Procedure in Case of Malfunctioning3-2

CHAPTER 4 – SOFTWARE MANAGEMENT

4.1 Introduction4-1
4.2 Accessing, Using and Exiting Monitor Mode.....4-1
4.3 Screen Explanations4-2
4.4 General Information Window4-2
4.5 Configuration Window4-2
System Parameters4-3
Right/Left Module Configuration.....4-4
ASCII Terminal Configuration4-5
4.6 Diagnostics Window4-6
General Reset4-6
Modules Reset and Self-Test.....4-6
Last Self-Test Results4-6
4.7 Performance Monitoring Window.....4-6
Link Status4-7
ATM Traffic Monitoring.....4-10

List of Figures

Figure 1-1 ARC-101 Rate Conversion Application	1-1
Figure 2-1 Installation of a Single Unit	2-2
Figure 2-2 Installation of Two Units	2-3
Figure 2-3 ARC-101 Front Panel.....	2-3
Figure 2-4 Jumper Settings for DTE (Two upper pins connected)	2-4
Figure 2-5 Jumper Settings for DCE (Two lower pins connected)	2-4
Figure 2-6 ARC-101 Rear Panel (AC Version)	2-5
Figure 2-7 ARC-101 Rear Panel (DC Version).....	2-5
Figure 2-8 SC13M/155 Module Front Panel	2-6
Figure 2-9 ST13S/155 Module Front Panel	2-6
Figure 2-10 ST13L/155 Module Front Panel	2-7
Figure 2-11 CX/BNC/155 Module Front Panel.....	2-7
Figure 2-12 UTP/155 Module Front Panel	2-8
Figure 2-13 E3 Module Front Panel.....	2-9
Figure 2-14 T3 Module Front Panel.....	2-9
Figure 2-15 E1 Module Front Panel.....	2-10
Figure 2-16 E1 and E1/LTU Jumper Locations.....	2-12
Figure 2-17 T3 Jumper Locations.....	2-13
Figure 3-1 ARC-101 Front Panel.....	3-1
Figure 3-2 ARC-101 Block Diagram.....	3-3

List of Tables

Table 1-1 Optical Module Characteristics.....	1-5
Table 1-2 Electrical Module Characteristics	1-5
Table 3-1 ARC-101 LED Indicators.....	3-1

Chapter 1

Introduction

1.1 General Description

The ARC-101, ATM Rate & Media Converter, provides transparent ATM rate and media conversion between two interfaces by extracting ATM cells from one interface at one rate and sending them over a different interface at a different rate.

The ARC-101 supports a wide variety of ATM data rates and media types. These include: E1, E3, T3 and STS-3c/STM-1, over optical and electrical interfaces.

The ARC-101 is supplied as a standalone unit. Special hardware for mounting the unit in a 19" rack can be ordered separately.

A typical ARC-101 rate conversion application is shown in *Figure 1-1*.

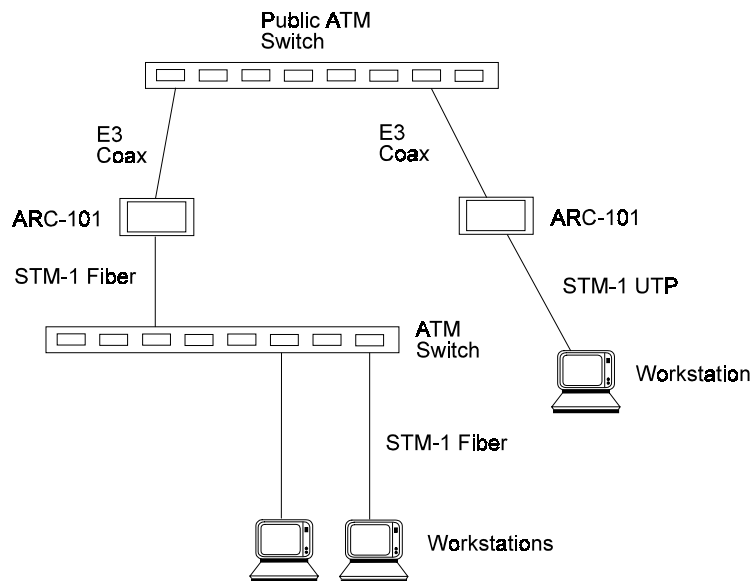

Figure 1-1 ARC-101 Rate Conversion Application

1.2 ARC-101 Features

This section provides a brief description of the ARC-101's main features.

Interfaces Supported

The ARC-101 supports a wide variety of ATM data rates and media types, both electrical and optical.

The electrical interfaces supported are:

- 2 Mbps E1 over Coax/UTP
- 34 Mbps E3 over Coax
- 45 Mbps T3 over Coax
- 155 Mbps STS-3c/STM-1 over Coax
- 155 Mbps STS-3c/STM-1 over Cat-5 UTP

The optical interfaces supported are: Multimode, Single Mode LEDs and LASERs and 155 Mbps STM-1/STS-3c.

Multiple connector types are available for both electrical and optical interfaces.

Rate Adaptation

A large internal FIFO is used for rate adaptation between the two interfaces and for handling the bursty nature of the ATM traffic. Special circuitry is responsible for closing the ATM flow control loop, according to Available Bit Rate (ABR) traffic management specifications, in order to avoid FIFO overflow.

Easy Migration

The modular software-based design of the ARC-101 enables easy migration to new ATM physical interfaces.

User Management and Monitoring

Built-in diagnostics, configuration and statistics are provided via an ASCII terminal connected to the RS-232 CONTROL port.

Indicators

LED indicators provide information on ARC-101 general status (power and self-test), as well as left and right link status (ATM activity and link synchronization).

Compatibility

The ARC-101 complies with ATM Forum specifications.

Traffic Management

ATM cells are transferred from one interface to the other through an internal bus, the bandwidth of which is 180 Mbps.

- Cells that are received with a multiple-bit HEC error are dropped.
- Cells received at the slower interface are transferred directly to the other interface.
- Cells received at the faster interface are transferred through the FIFO which absorbs temporary bursts of ATM cells and transfers them according to the other interface data rate.
- The FIFO depth is 6K cells in SONET/SDH interfaces and 3K cells in other interfaces.

The ARC-101 implements a single priority queue FIFO. Special circuitry is responsible for the traffic management and for avoiding FIFO overflow.

- The total bandwidth of CBR cells cannot exceed the slow interface bandwidth.
- The total bandwidth of VBR cells can only temporarily exceed the slow interface data rate. If this bandwidth is exceeded, cells are queued in FIFO and are transferred according to the slow interface data rate.
- The ARC-101 has a configurable congestion threshold (limit) used to handle UBR/ABR traffic. You can configure the threshold to be 25%, 50%, 75%, 90% or 100% of the total FIFO depth.
- In order to control the UBR/ABR traffic bandwidth, you can configure the ARC-101 for EFCI marking of cells that are received while the FIFO is congested, or configure AAL5 Early Packet Discard mode in which a whole frame is dropped in case of congestion, except for the last cell.
- You can configure the ARC-101 to discard cells whose CLP bit is set, when FIFO is congested.
- The number of cells from a certain VP/VC is limited to 3/4 of the total queue depth, in order to minimize the effects of large bursts of data from one VC on the other VCs in the ARC-101.
- The ARC-101 recalculates the HEC field of cells whose EFCI bit was changed.

Loopback Mode

Each ARC-101 interface can be separately configured for Remote or Internal Loopback mode. The Remote Loopback mode enables a loopback of the incoming data and clock to the transmit data and clock outputs. The Internal Loopback mode enables a loopback of the transmitted data to the received data. Remote Loopback is not available in the E1 interface.

1.3 Specifications

Data Rate		Up to 155 Mbps
Indicators	<i>PWR</i>	ON when unit is powered
	<i>FLT</i>	BLINKS when self-test fails (ON during self-test)
	<i>ATM</i>	ON when ATM cells were transmitted and received in the last second and no uncorrected HEC errors were detected.
	<i>SYNC</i>	ON when the port is synchronized (no alarm) OFF during local alarm BLINKS during remote alarm reception
Control Port	<i>Interface</i>	RS-232/V.24 at 9600/19200/38400 baud (configurable) with RJ-45 connector. Default - 9600 baud.
Power	Voltage	90-260 VAC or -48 VDC
	Frequency	47-63 Hz
	Power	25 Watts
Physical	Height	4.4 cm / 1.8 in (1U)
	Width	21.6 cm / 8.5 in
	Depth	29.8 cm / 11.7 in
	Weight	1.1 kg / 2.8 lb
Environment	Temperature	0°-45°C/32°-113°F
	Humidity	Up to 90%, non-condensing
	Radiation Suppression	Complies with FCC part 15, subpart J, Class A Complies with EN55022, Class A

Ordering**ARC-101/#**

ATM Rate Converter

- # Specify power supply:
 AC for 90-260 VAC
 DC for - 48 VDC

ARC-M/@

Interface module for ARC-101

- @ Specify module name - see tables below

RM-1

Hardware for mounting one unit in a 19" rack.

RM-2

Hardware mounting for two units in a 19" rack.

Table 1-1 Optical Module Characteristics

Module Name	Protocols Supported	Fiber Type (Wavelength)	Connector Type	Dynamic Range	Optical Power (typical)	Sensitivity
SC13M/155	STS-3c STM-1	62.5/125 (1300 nm)	Duplex SC	16 dB	-18 dBm	-31 dBm
ST13S/155	STS-3c STM-1	9/125 (1300 nm)	ST (LED)	16 dB	-18 dBm	-31 dBm
ST13L/155	STS-3c STM-1	9/125 (1300 nm)	ST (LASER)	16 dB	-12 dBm	-31 dBm

Table 1-2 Electrical Module Characteristics

Module Name	Protocols Supported	Cable Type	Connector Type	Range/Budget	Coding Method	Impedance (Ohms)
UTP/155	STS-3c STM-1	UTP Cat 5	Shielded RJ-45	100 m	NRZ	100
CX/BNC/155	STS-3c STM-1	Coax	BNC	12.7 dB*	CMI	75
T3	T3	Coax	BNC	150 m	B3ZS	75
E3	E3	Coax	BNC	150 m	HDB3	75
E1	E1	Coax (UTP)	BNC (RJ-45)	12 dB	HDB3	75 (120)
E1/LTU	E1	Coax (UTP)	BNC (RJ-45)	12 dB	HDB3	75 (120)

* At 78 MHz, according to the square root of the frequency law.

Chapter 2

Installation

This chapter contains mechanical and electrical installation procedures for connecting the ARC-101 to the main power supply, as well as cabling the ATM links and monitor (control) port.

2.1 General

The ARC-101 is delivered completely assembled for bench-top installation. The ARC-101 may be optionally installed in a 19" rack (refer to *Section 2.4*).

2.2 Unpacking

- Inspect the equipment container before unpacking. Note and report evidence of damage immediately.
- Place the container on a clean flat surface. Cut all straps and open, or remove top.
- Remove the unit carefully and place it securely on a clean surface.
- Remove all packing material and inspect the unit for damage. Report any damage immediately.

2.3 Site Requirements

Power

The ARC-101 is powered by 90/260 VAC or -48 VDC.

The unit should be installed within 1.5 meters (5 ft.) of an easily accessible grounded AC outlet capable of supplying the appropriate voltage (90/260 VAC).

Front and Rear Panel Clearance

Allow at least 90 cm (36 inches) of clearance at the front of the unit for operator access. Allow at least 10 cm (4 inches) clearance at the rear of the unit for power cord connection.

Ambient Requirements

The ambient operating temperature of the ARC-101 should be 0°C to 45°C (32°F-113°F), at a relative humidity of up to 90% non-condensing.

2.4 Rack Mounting Instructions

Installation of a Single Unit

Rack adapter components for installing a single unit include one short bracket and one long bracket. Each bracket is fastened to the side walls of the unit by two screws (with flat washers) which are inserted into the two front holes on the side wall (the unit is supplied with nuts already in place on the inner side wall). Note that the short bracket fastens to the left side of the unit, and the long bracket to the right side of the unit (see *Figure 2-1*).

Once the brackets are fastened to the side walls, the unit is ready for installation in the 19" rack. Place the unit in the rack, and fasten the brackets to the side rails of the rack by means of the two screws situated on each side (not included in the kit).

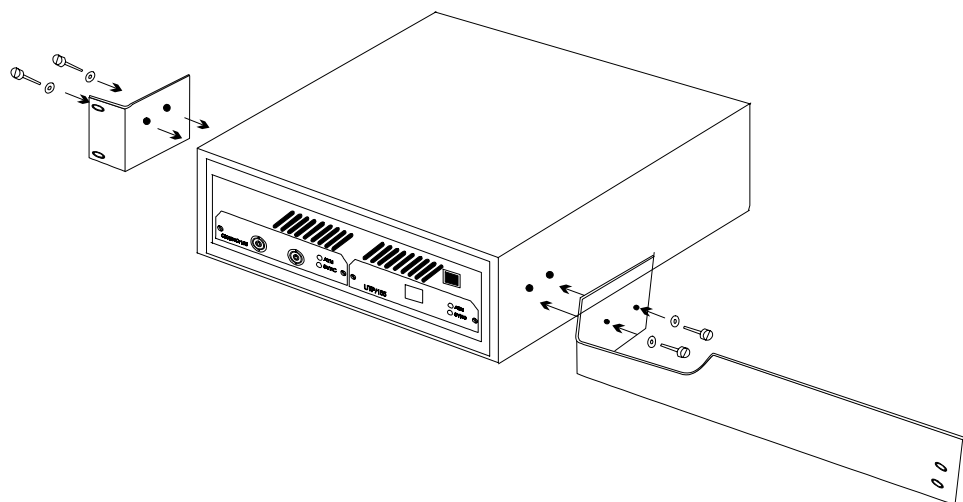

Figure 2-1 Installation of a Single Unit

Installation of Two Units

Rack adapter components for installing two units include two short side brackets (for rack mounting) and two flat rails (for fastening the two units together)

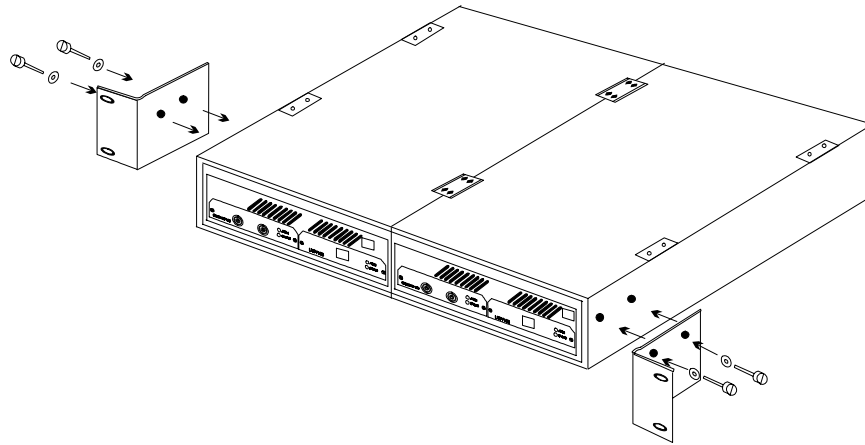

Figure 2-2 Installation of Two Units

To install two units follow these instructions:

1. Place two units side by side. On the top of each unit are four grooves. The grooves should line up when the units are placed side by side.
2. Place a flat rail on each of the grooves in the center of the two units.
3. Fasten the brackets to the units using the 8 screws provided.
4. Place the assembled units in the rack, and fasten the brackets to the side rails of the rack, by means of the two screws situated on each side, as shown in *Figure 2.2* (not included in the kit).

2.5 Cable Connections

The ARC-101 has several connectors on its front panel (see *Figure 2-3*) for ATM connection and connection to an ASCII terminal, and a power connector on its rear panel.

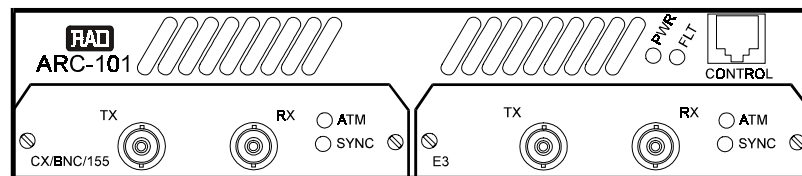

Figure 2-3 ARC-101 Front Panel

ATM Connection

Connect the appropriate cables to the connectors in both modules.

Control Port Connection

The CONTROL port connector is an RS-232/V.24 RJ-45 connector for an ASCII terminal (9600 baud).

When the ARC-101 is used as a DCE or as a DTE, the RJ-45 pinout is:

Pinout	DCE	DTE
Pin 1		
Pin 2		
Pin 3		DTR
Pin 4	GND	GND
Pin 5	TX Data	RX Data
Pin 6	RX Data	TX Data
Pin 7		CTS
Pin 8		
Pin 9		RTS

Changing Control Port Mode

The ARC-101 is shipped as a DCE. To connect the ARC-101 to a MODEM, the control port mode must be configured to DTE.

To change the control port mode from DCE to DTE, or vice versa:

1. Turn the unit OFF (disconnect the power cord).
2. Unscrew the twelve box cover screws and remove the box cover. The 12 pin DCE/DTE jumper is located on the left side of the ARC-101 mother board when viewed from the rear panel (see *Figure 3-2*).
3. To change the configuration to:
 - DTE, place the 12 pin jumper on the upper 12 pins.
 - DCE, place the 12 pin jumper on the lower 12 pins.
4. Replace the box cover and tighten the screws.



*Figure 2-4 Jumper Settings for DTE
(Two upper pins connected)*



*Figure 2-5 Jumper Settings for DCE
(Two lower pins connected)*

AC Power Connection

The ARC-101's power connector is located on its rear panel (see *Figures 2-6* and *Figure 2-7*).

AC power should be supplied to the ARC-101 through a 1.5 m (5 ft.) standard power cord terminated by a grounded 3-wire plug.



When applying AC power, first connect the plug of the AC cable to the power connector on the rear panel of the ARC-101 and then to the mains outlet.

Grounding



Interrupting the protective (grounding) conductor (inside or outside the instrument) or disconnecting the protective earth terminal can make this instrument dangerous. Intentional interruption of the grounding conductor is prohibited.

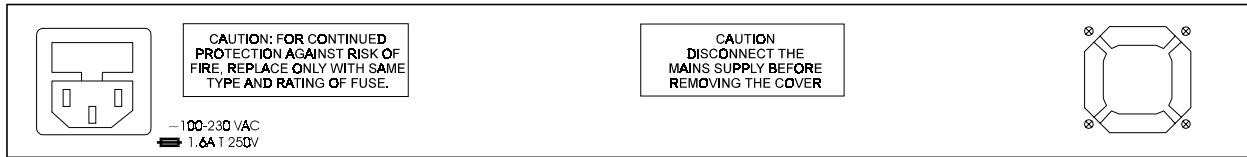

Figure 2-6 ARC-101 Rear Panel (AC Version)



Figure 2-7 ARC-101 Rear Panel (DC Version)

2.6 ARC-101 Modules

Module Characteristics

SC13M/155 Module

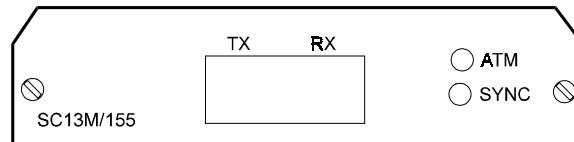

Figure 2-8 SC13M/155 Module Front Panel

Wavelength:	1300 nm
Connector:	SC
Used with:	Multimode fiber
Protocols supported:	STS-3c, STM-1
Coding method:	NRZ
Optical output into 62.5 micron fiber:	-18 dBm (typical)
Receiver sensitivity:	-31 dBm
Maximum input power:	-15 dBm

ST13S/155 Module

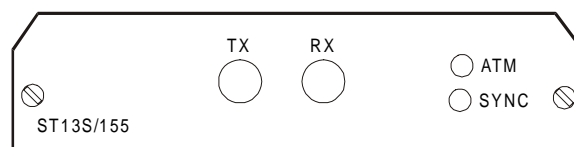

Figure 2-9 ST13S/155 Module Front Panel

Wavelength:	1300 nm
Connector:	ST
Used with:	Single mode fiber (LED)
Protocols supported:	STS-3c, STM-1
Coding method:	NRZ
Optical output into 9 micron fiber:	-18 dBm (typical)
Receiver sensitivity:	-31 dBm
Maximum Input Power:	-15 dBm

ST13L/155 Module

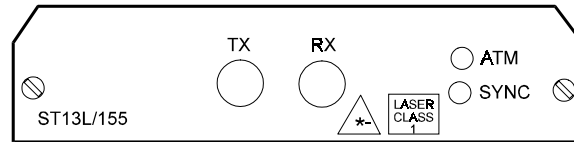

Figure 2-10 ST13L/155 Module Front Panel

Wavelength:	1300 nm
Connector:	ST
Used with:	Single mode fiber (LASER)
Protocols supported:	STS-3c, STM-1
Coding method:	NRZ
Optical output into 9 micron fiber:	-12 dBm (typical)
Receiver sensitivity:	-31 dBm
Maximum Input Power:	-15 dBm

CX/BNC/155 Module

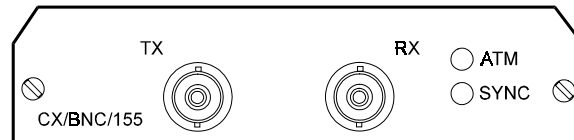

Figure 2-11 CX/BNC/155 Module Front Panel

Connector:	BNC
Used with:	Coax cable
Protocols supported:	STS-3c, STM-1
Coding method:	CMI
Budget:	12.7 dB*
Impedance:	75 Ω
Transmit levels:	1v +/- 0.1v P-P

*At 78 MHz, according to the square root of frequency law.

UTP/155 Module

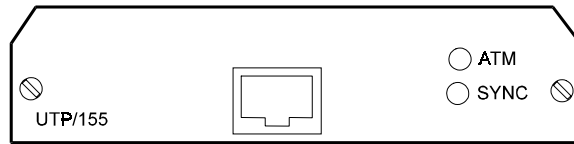

Figure 2-12 UTP/155 Module Front Panel

Connector:	Shielded RJ-45
Used with:	UTP Cat 5
Protocols supported:	STS-3c, STM-1
Coding method:	NRZ
Range:	100 m
Impedance:	100 Ω
Transmit levels:	1v +/- 0.06v

Pinout	
Pin 1	Tx+
Pin 2	Tx-
Pin 3	
Pin 4	
Pin 5	
Pin 6	
Pin 7	Rx+
Pin 8	Rx-

E3 Module

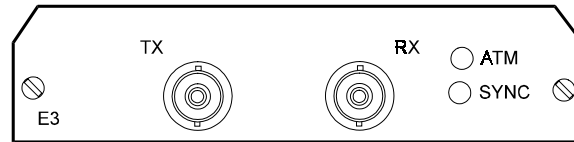

Figure 2-13 E3 Module Front Panel

Connector:	BNC
Used with:	Coax cable
Protocols supported:	E3
Coding method:	HDB3
Range:	150 m
Impedance:	75 Ω
Transmit	1v +/- 0.06v

T3 Module

The transmit pulse shape can be determined by jumpers on the module (refer to *Jumper Settings for E1 & E1/LTU*).

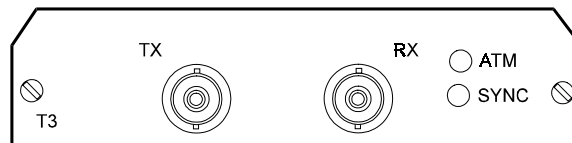

Figure 2-14 T3 Module Front Panel

Connector:	BNC
Used with:	Coax cable
Protocols supported:	DS3
Coding method:	B3ZS
Range:	150 m
Impedance:	75 Ω

E1 and E1/LTU Modules

The E1 link interface (Coax/UTP), as well as RX/TX ground reference, can be determined by jumpers on the module (see *Figure 2-16*).

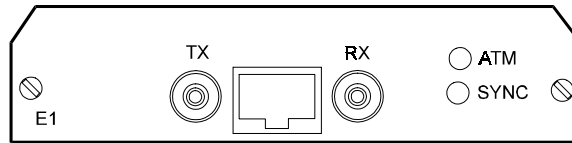

Figure 2-15 E1 Module Front Panel

Connector:	BNC (RJ-45)
Used with:	Coax (UTP)
Protocols supported:	E1
Coding method:	HDB3
Impedance:	75 Ω (120 Ω)
Receive level (with LTU):	0 to -34 dB
Receive level (without LTU):	0 to -12 dB
Transmit level balanced:	3v \pm 10%
Transmit level unbalanced:	2.37v \pm 10%

Inserting and Removing Modules

Inserting Modules

To insert a module:

1. Turn the unit OFF (disconnect the power cord).
2. Pull on the screws on the module's front panel, so they hang outwards a little.
3. Insert the module onto the sliders, and push the module slowly into the unit (make sure that the module is correctly aligned on the sliders).
4. When the module is almost completely in, push hard, until the module clicks into the unit.
5. Tighten the screws on the module's front panel.

Removing Modules

To remove a module:

1. Turn the unit OFF (disconnect the power cord).
2. Unscrew the screws on the module's front panel.
3. Pull the screws hard, until the module dislodges from the unit (please pull out the module with care!)
4. Slowly slide the module out of the unit.

Jumper Settings for E1 and E1/LTU

The jumpers JP5, JP6, JP10, JP11 and JP13 are used to select the link interface (Coax or UTP). See *Figure 2-16*.

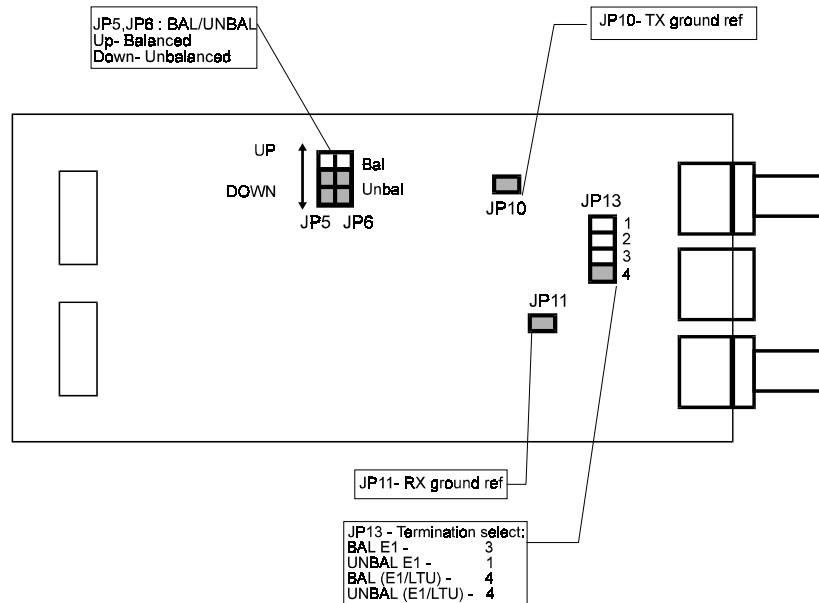
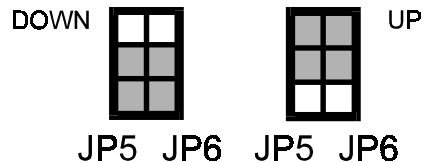

Figure 2-16 E1 and E1/LTU Jumper Locations

Note

Turn the module upside down in order to see and move the jumpers.

- JP5, JP6: Designated BAL/UNBAL.



BAL (up) for operation in Balanced mode (UTP).

UNBAL (down) for operation in Unbalanced mode (Coax, default).

- JP10: Place the jumper to connect the BNC shield or RJ-45 screen on the TX side to earth (recommended for unbalanced mode)
- JP11: Place the jumper to connect the BNC shield or RJ-45 screen on the RX side to earth (recommended for balanced mode).
- JP13: Designate BAL/UNBAL.

Position 1 for Unbalanced mode with E1 module.

Position 3 for Balanced mode with E1 module.

Position 4 for Balanced mode with E1/LTU module.

Position 4 for Unbalanced mode with E1/LTU module.

Jumper Settings for T3

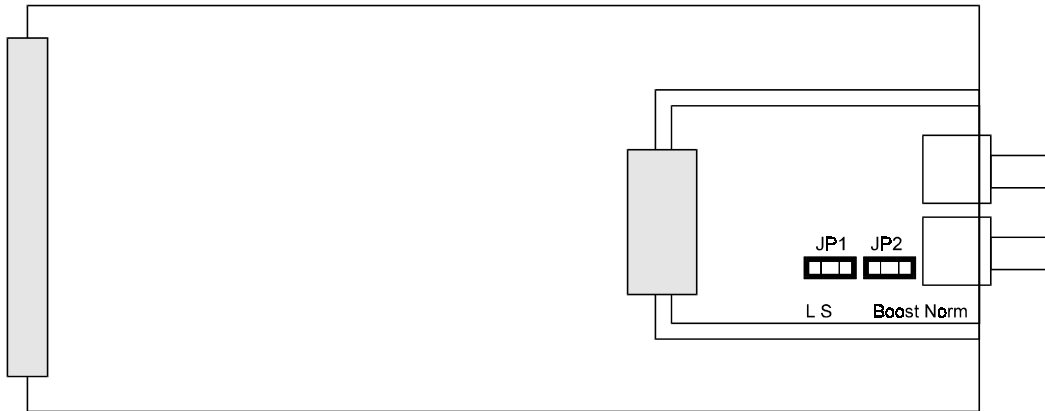

Figure 2-17 T3 Jumper Locations

The jumpers JP1 and JP2 (located near the front panel of the module), are used to control the transmit levels, and should be set according to the length of the links (see *Figure 2-17*).

T3:

JP1: Designated L/S

L (Long) for operation with Coax cables longer than 225 feet on the transmit side

S (Short) for operation with Coax cables shorter than 225 feet on the transmit side (default)

JP2: Designated NORM/BOOST

NORM: For transmit level conforming ANSI.102 (default)

BOOST: For higher level transmit pulse

Chapter 3

Operation

The ARC-101 has several LED indicators, providing information on the ARC-101's general status, as well as right and left module status (see *Figure 3-1*). The indicators are ON, OFF, or BLINK, depending on the state of ARC-101. Table 3-1 lists the functions of the front panel indicators.

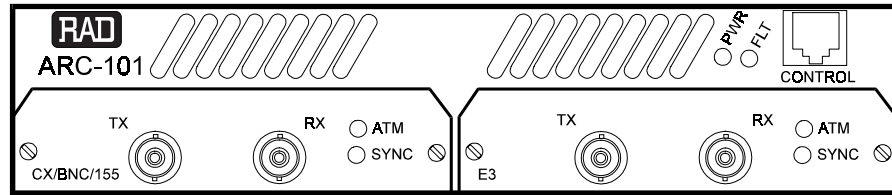

Figure 3-1 ARC-101 Front Panel

Table 3-1 ARC-101 LED Indicators

Name		Description
PWR (green)	ON	When ARC 101 is powered.
FLT (red)	BLINKS	Error detected during self-test <ul style="list-style-type: none"> - If the error is in one of the modules, the module's two LEDs blink; - In case of a system error, the two module's LEDs blink.
	ON	During self-test
ATM (green)	ON	During active ATM connections on the module's port: That is when <u>no</u> HEC error was detected during the last second and, at least one cell was received and transmitted in the last second.
SYNC (green)	ON	When the module's port is synchronized (no alarm)
	OFF	During local alarm (a fault is detected on the receive side of ARC-101).
	BLINKS	During remote alarm the remote unit signals that a fault has been detected.

3.1 Operating Procedure

Note

The interface modules are not hot-swappable. If you install or change modules, make sure to first disconnect power to the ARC-101, and then remove/install modules slowly and carefully (so as not to damage the modules or the ARC-101 enclosure). See section 2.6.

Turning on the ARC-101

Install the ARC-101 as described in *Chapter 2*. Make sure that the power cord is connected to the ARC-101's power connector on the rear panel. Plug the other end of the power cord into the mains outlet. The PWR indicator on the front panel should light.

Upon power-up, the ARC-101 goes through a self-test that takes about 40 seconds to complete. The FLT indicator is ON during the self-test. After the self-test is completed, if no faults have been detected, the FLT indicator is OFF. Detailed test results can be viewed from an ASCII terminal connected to the ARC-101's CONTROL port.

Normal Operation

The ARC-101 operates unattended. During normal operation, the PWR indicators should light continuously, the FLT indicator should be OFF, the ATM indicator should light up when ATM traffic passes through the module, and the SYNC indicator should light up continuously.

Turning off the ARC-101

To turn off the ARC-101, disconnect the power cord from the mains outlet.

Procedure in Case of Malfunctioning

The following table lists several common problems and their possible solutions.

The PWR LED does not light up	<ul style="list-style-type: none"> – Check the power cord connection on the back of the unit and at the mains outlet. – Verify power availability at the mains outlet.
Fault (FLT) LED blinks	<ul style="list-style-type: none"> – Unplug the unit (power OFF). Make sure that the modules are inserted properly. Tighten the modules' screws. Power ON the unit. – Using an ASCII terminal port, check for a fault indication in the Diagnostics window. If there is a fault, inform a qualified ARC-101 technician.
Data transmission difficulties	<ul style="list-style-type: none"> – Ensure that the plugged-in modules are compatible with the protocol used (media, data rate). – Check the module's software configuration in the Configuration window. – Verify that the SYNC indicator is ON. If it is OFF (indicating a fault in the data reception link), run diagnostics on the remote unit from which data is being transmitted to the ARC-101. If it is BLINKING (indicating a fault in the data transmission link), run diagnostics on the remote unit, or implement a loop on the ARC-101 module, and verify that the SYNC LED is ON.

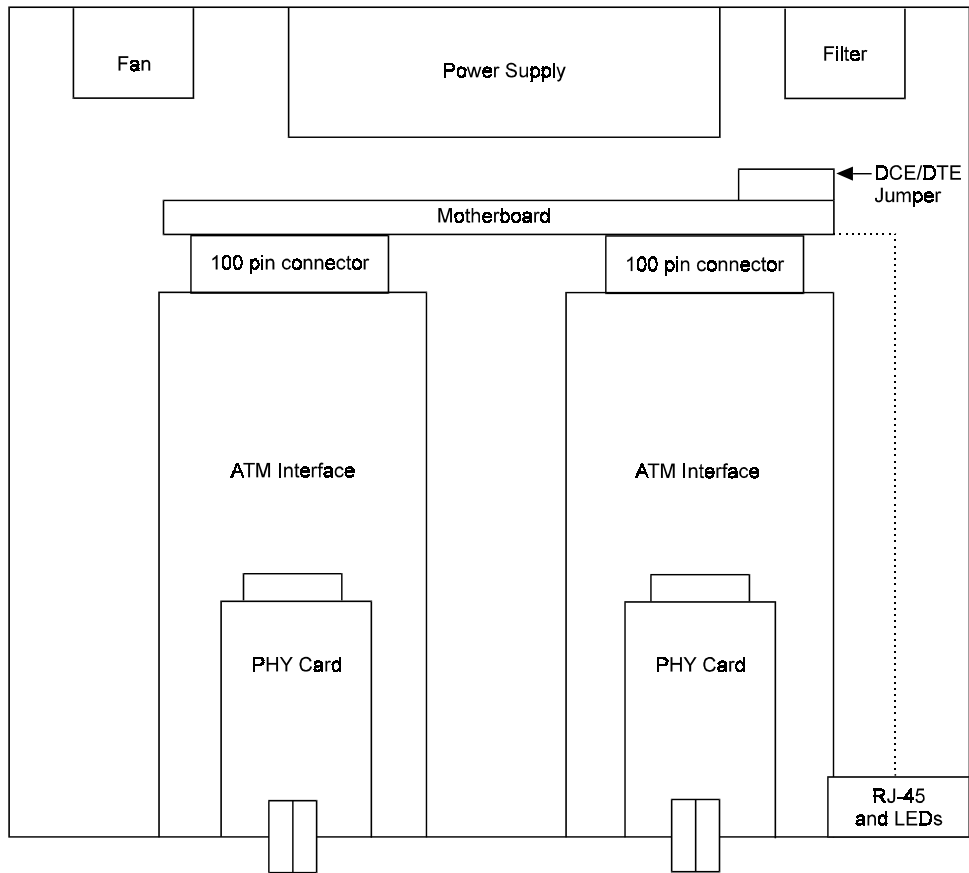

Figure 3-2 ARC-101 Block Diagram

Chapter 4

Software Management

4.1 Introduction

Monitor mode enables software management of the ARC-101. Four categories of software management are available:

- Monitoring the ARC-101 general information via the General Information window.
- Changing default configuration parameters via the Configuration window.
- Testing and resetting the ARC-101 via the Diagnostics window.
- Monitoring the ARC-101 performance and status via the Performance Monitoring window.

4.2 Accessing, Using and Exiting Monitor Mode

To Access Monitor Mode

To access Monitor mode from the supervisory terminal, perform the following:

Connect an ASCII ANSI terminal or a PC capable of emulating an ASCII ANSI terminal to the RJ-45 CONTROL connector on the front panel of the ARC-101. Terminal communication port setup should have a baud rate of 9600 bps, 8 bits/character, one stop bit, no parity.

- If using a PC, run a terminal emulation program.
- Make sure the ARC-101 is ON.
- After a few seconds (during which the ARC-101 executes its self-test), the main menu will be displayed on the screen.

```
ARC MENU
1. General Information
2. Configuration
3. Diagnostics
4. Performance Monitoring
ESC. Exit
Choose item from the menu:
```

To select an option, select the item number corresponding to the option. If no change is required, press the Escape key (Esc).

4.3 Screen Explanations

Each of the screens shown below is followed by a detailed explanation of the parameters and options appearing in the screen.

- The acceptable value range for each parameter, where applicable, is shown in parentheses – "()".
- The default value for each parameter, where applicable, appears in the screens.

4.4 General Information Window

To view general information about the ARC-101, such as software/hardware versions, basic configuration and self-test results, select option 1 from the main menu.

```

GENERAL INFORMATION
Software Version:          0.0
Hardware Version:         0.0
ATM Rate Converter Configuration:
Self-Test ended successfully
E1                          STM-1
over                to                over
UTP/COAX                FIBER

```

4.5 Configuration Window

Default configuration parameters can be changed via the Configuration window. To enter the Configuration window, select option 2 in the main menu. The Configuration screen is divided into 6 submenus/commands: System Parameters, Left Module parameters, Right Module parameters, ASCII Terminal Configuration parameters, Set Default Parameters and Save Changes. Note that some parameters are general while some depend on the module type.

To Set a Parameter:

- Select the item number which corresponds to the parameter that you want to view/configure.

To Save the Configuration:

```

                                CONFIGURATION
1. System Parameters
2. Left Module
3. Right Module
4. ASCII Terminal Configuration
5. Set Default Parameters
6. Save Changes

ESC. Exit

```

- After making all changes, return to the Configuration window, and select option 6. If a new value was entered at any menu, the following prompt will appear upon exiting the menu:

ALL CHANGES WILL BE SAVED. ARE YOU SURE? (Y/N)

- Type **Y** for "Yes", or press any other key for "No".

Note

If you change a module, the ARC-101 will reboot with its default parameters.

To Set Default Parameters

To return all configuration parameters to their factory defaults, go to the Configuration window, and select option 5.

Note

If you set the Default Parameters, the Baud Rate parameter will be changed and saved as 9600. The ASCII Terminal Baud will be changed to 9600 the next time the ARC is restarted.

System Parameters

To set system parameters, select option 1 from the Configuration menu.

```

                                SYSTEM PARAMETERS
1. FIFO Congestion Threshold: 90%
2. EFCI Marking:                Disable
3. CLP Dropping:                Disable
4. Early Packet Discard:        Disable

ESC. Exit
Select item from the menu:

```

FIFO Congestion Threshold

(Default - 75%); options: 25%, 50%, 75%, 90%, 100%

The FIFO threshold in which the ARC-101 will enter the "congestion" state

The options are 25%, 50%, 75%, 90% and 100%.

EFCI Marking

(Default - Disable); options: Enable, Disable

Enables EFCI marking while FIFO is in congested state. Setting this parameter to Enable causes the EFCI marking of all cells that are received, while FIFO is in a congested state.

CLP Dropping

(Default - Disable); options: Enable, Disable

Enables CLP dropping when FIFO is congested. Setting this parameter to Enable causes cells - with CLP bit set - to be dropped, if they are received while FIFO is in a congested state.

Early Packet Discard

(Default - Disable); options: Enable, Disable

Enables entire frame, except for last cell, to be dropped when FIFO is congested. Setting this parameter to Enable causes frames to be dropped, if they are received while FIFO is in a congested state.

Right/Left Module Configuration

The two windows (Left and Right module configuration, options 2 and 3 in the Configuration menu) are identical.

```

LEFT MODULE

1. Port Enable/Disable:  Enable
2. Transmit Clock Source:  Loopback
3. Loopback State:      Disable
4. SONET/SDH Frame Type:  STM-1 (SDH)

ESC. Exit
```

Port Enable/Disable (Default - Enable); options: Enable, Disable

If the port is Disabled, no data will be received at the port. Transmit functions are not changed. Remote loop is still available. If the port is Enabled, received data is transferred to the other port.

Transmit Clock Source

(Default - Local timing); options: Local timing, Loopback timing

This parameter selects the clock source for the transmit clock. "Local timing" selects the clock that is derived from the oscillator on board. "Loopback timing" selects the clock recovered from the received data to be the source. Note that for an E1 interface, the default is "Loopback timing" and should not be changed. Do not configure the module for Loopback timing while it is in Internal Loopback mode.

Loopback State (Default - Disable); options: Disable, Remote, Internal

Setting this parameter to Remote will cause a loopback of the incoming data and clock to the transmit data and clock (this option is not supported with E1). Internal Loopback will cause a loopback of the transmitted data to the receive port.

SONET/SDH Frame Type (Default - STM-1); options: STS-3c, STM-1

This parameter is only used in 155 Mbps cards. It defines the Frame Type to be STS-3c (SONET) or STM-1 (SDH).

DS3 Mapping (Default - Direct); options: Direct, PLCP-Ext' 8Kclk, PLCP-Int' 8Kclk

This parameter is only used in T3 card. It selects the DS3 mapping and the PLCP clock, in case of PLCP mapping. Direct mode is the HEC mapping mode. PLCP mapping with Internal 8Kclk forces the transmit PLCP to be synchronized to an on-board clock. PLCP with External 8Kclk uses the received PLCP clock as a reference.

ASCII Terminal Configuration

To set ASCII terminal parameters, select option 4 from the Configuration menu.

```
ASCII TERMINAL CONFIGURATION
1. Display Mode:      Color
2. Baud Rate:        9600 Kbps

ESC. Exit
Select item from the menu:
```

Note *When you change the module's baud rate, you will lose communication with the module, until you adjust the baud rate of ASCII terminal or PC to match the baud rate of the module.*

The default display mode is Color. The default baud rate is 9600.

To change the baud rate:

1. Set the required baud rate on the ARC-101 monitor (option 2 in the ASCII terminal configuration window).
2. Press the Escape key (ESC).
3. Change the ASCII terminal baud rate.
4. A "Press ESC" message will appear on the monitor while synchronization is achieved.

4.6 Diagnostics Window

The ARC-101 can be tested and reset via the Diagnostics window. To enter the Diagnostics window, select item number 3 in the main menu.

The Diagnostics window includes the following options:

- General Reset
- Modules Reset & Self-test
- Last Self-Test Results
- Self-test results are displayed on-screen.

```
DIAGNOSTICS
1. General Reset
2. Module Reset & Self-Test
3. Last Self-Test Results

ESC. Exit
Select item from the menu:
```

General Reset

This mode enables a full test of the ARC-101. This self-test enables checking the modules and system card, in addition to the tests performed during the right/left module self-tests.

Modules Reset and Self-Test

A self-test can be performed on the ARC-101's modules, including the testing of the ATM interfaces and PHY cards.

Last Self-Test Results

This option is used to monitor the self-test results.

4.7 Performance Monitoring Window

ARC-101 performance and status can be viewed via the Performance Monitoring window. To enter the Performance Monitoring window, select item number 4 in the main menu. The window provides an option to reset the counters and includes two windows:

- Link Status
- ATM Status

```

PERFORMANCE MONITORING

1. Link Status
2. ATM Status
3. Reset Counters

ESC. Exit
    
```

Link Status

The Link Status window displays:

- The number of alarms and errors detected in the last second ("Last Second" column).
- The number of errors detected since the last counter reset or overflow ("All" column).
- The time (in seconds) since the last counter reset.

Link Status						
STS-3C (FIBER)	Last Second	ALL	T3 (Coax)	Last Second	ALL	
LOS	0	0	LOS	0	0	
LOF	0	0	OOF	0	0	
LOP						
LOC	0	0	AIS	0	0	
SLM	0	0	Yellow	0	0	
Line AIS	0	0	BIP	0	0	
Path AIS	0	0	FEBE	0	0	
Line FERF/RDI	0	0	P1/P2	0	0	
Path FERF/RDI	0	0				
Section BIP	0	0	PLCP LOF	0	0	
Line BIP	0	0	PLCP YELLOW	0	0	
Path BIP	0	0				
Line FEBE	0	0	PLCP BIP	0	0	
Path FEBE	0	0	PLCP FEBE	0	0	

Example: Link Status window for ARC-101 in SONET-T3 configuration

SONET/SDH Link Status Window

LOS	Loss of Signal
LOF	Loss of Frame
LOP	Loss of Pointer
LOC	Loss of Cell Delineation
SLM	Signal Cable Mismatch
Line AIS	Line Alarm Indication Signal
Path AIS	Path Alarm Indication Signal
Line FERF/RDI	Line Far End Receive Failure/Remote Defect Indicator
Path FERF/RDI	Path Far End Receive Failure/Remote Defect Indicator
A '0' in the "Last Sec" columns of the Alarms listed above, indicates that no errors have occurred. A '1' in the "Last Sec." column indicates that there are one or more errors in the last second. The number in the "All" column is equal to the cumulative number of seconds in which errors occurred.	
Section BIP	Section Bit Interleaved Parity
Line BIP	Line Bit Interleaved Parity
Path BIP	Path Bit Interleaved Parity
Line FEBE	Line Far End Block Error
Path FEBE	Path Far End Block Error

T3 Link Status Window - Errors/Alarms displayed in Direct (HEC) Mode

LOS	Loss of Signal
OOF	Out of Frame
LOC	Loss of Cell Delineation
AIS	Alarm Indication Signal
Yellow	Yellow Alarm
A '0' in the "Last Sec" columns of the Alarms listed above, indicates that no errors have occurred. A '1' in the "Last Sec." column indicates that there are one or more errors in the last second.	
BIP	Bit Interleaved Parity
FEBE	Far End Block Error
P1/P2	P1/P2

T3 Link Status Window - Errors/Alarms displayed in PLCP Mode

LOS	Loss of Signal
OOF	Out of Frame
AIS	Alarm Indication Signal
Yellow	Yellow Alarm
PLCP_LOF	PLCP Loss of Frame
PLCP_Yellow	PLCP Yellow
<p>A '0' in the "Last Sec" columns of the Alarms listed above, indicates that no errors have occurred. A '1' in the "Last Sec." column indicates that there are one or more errors in the last second. The number in the "All" column is equal to the cumulative number of seconds in which errors occurred.</p>	
BIP	Bit Interleaved Parity
FEBE	Far End Block Error
P1/P2	P1/P2 Parity Error
PLCP_BIP	PLCP Bit Interleaved Parity
PLCP_FEBE	PLCP Far End Block Error

<u>Link Status</u>						
E3 (Coax)	last second	ALL	E1 (Coax/UTP)	last second	ALL	
LOS:	0	0	LOC:	0	0	
OOF:	0	0				
LOC	0	0				
AIS:	0	0				
RDI:	0	0				
BIP:	0	0				
FEBE:	0	0				

Example: Link Status window for ARC-101 in E3-E1 configuration

E3 Link Status Window

LOS	Loss of Signal
OOF	Out of Frame
LOC	Loss of Cell Delineation
AIS	Alarm Indication Signal
RDI	Remote Defect Indicator
A '0' in the "Last Sec" columns of the Alarms listed above, indicates that no errors have occurred. A '1' in the "Last Sec." column indicates that there are one or more errors in the last second. The number in the "All" column is equal to the cumulative number of seconds in which errors occurred.	
BIP	Bit Interleaved Parity
FEBE	Far End Block Error

E1 Link Status Window

LOC	Loss of Cell Delineation
A '0' in the "Last Sec" columns of the Alarms listed above, indicates that no errors have occurred. A '1' in the "Last Sec." column indicates that there are one or more errors in the last second. The number in the "All" column is equal to the cumulative number of seconds in which errors occurred.	

ATM Traffic Monitoring

ATM cell statistics are displayed in this window - the number of events that have occurred since counters reset or overflow in the right and left modules:

- Cells transmitted
- Cells received
- Cells discarded due to HEC errors

ATM STATUS					
Left Module	Last Sec.	All	Right Module	Last Sec.	All
Cells Transmitted:	1200	412000	Cells Transmitted:	1990	412010
Cells Received	1208	412020	Cells Received	1990	412000
Cells Discarded: (HEC errors)	0	0	Cells Discarded: (HEC errors)	0	0
Time since the last Counters Reset:			00:34:46		
Press ESC to exit					

Note *The Cells Transmitted counter is not valid in Remote Loopback mode, and the Cells Received counter is not valid in Internal Loopback mode.*

The counter precision is 1/10,000.

Free Manuals Download Website

<http://myh66.com>

<http://usermanuals.us>

<http://www.somanuals.com>

<http://www.4manuals.cc>

<http://www.manual-lib.com>

<http://www.404manual.com>

<http://www.luxmanual.com>

<http://aubethermostatmanual.com>

Golf course search by state

<http://golfingnear.com>

Email search by domain

<http://emailbydomain.com>

Auto manuals search

<http://auto.somanuals.com>

TV manuals search

<http://tv.somanuals.com>