

# AMC-101

## Universal Media Converter and Repeater Installation and Operation Manual

---

### Notice

This manual contains information that is proprietary to RAD Data Communications. No part of this publication may be reproduced in any form whatsoever without prior written approval by RAD Data Communications.

No representation or warranties for fitness for any purpose other than what is specifically mentioned in this manual is made either by RAD Data Communications or its agents.

For further information contact RAD Data Communications at the address below or contact your local distributor.

**RAD data communications  
Headquarters**

12 Hanechoshet Street  
Tel Aviv 69710 Israel  
Tel: 972-3-6458181  
Fax: 972-3-6498250  
E-mail: rad@rad.co.il

**RAD data communications  
US East**

900 Corporate Drive  
Mahwah, NJ 07430 USA  
Tel: (201) 529-1100  
Fax: (201) 529-5777  
E-mail: market@radusa.com

**RAD data communications  
US West**

3631 South Harbor Boulevard  
Suite 250  
Santa Ana, CA 92704  
Tel: (714) 850-0555  
Fax: (714) 850-1555



# Warranty

This RAD product is warranted against defects in material and workmanship for a period of one year from date of shipment. During the warranty period, RAD will, at its option, either repair or replace products which prove to be defective. For warranty service or repair, this product must be returned to a service facility designated by RAD. Buyer shall prepay shipping charges to RAD and RAD shall pay shipping charges to return the product to Buyer. However, Buyer shall pay all shipping charges, duties and taxes for products returned to RAD from another country.

## Limitation of Warranty

The foregoing warranty shall not apply to defects resulting from improper or inadequate maintenance by Buyer, Buyer-supplied firmware or interfacing, unauthorized modification or misuse, operation outside of the environmental specifications for the product, or improper site preparation or maintenance.

## Exclusive Remedies

The remedies provided herein are the Buyer's sole and exclusive remedies. RAD shall not be liable for any direct, indirect special, incidental, or consequential damages, whether based on contract, tort, or any legal theory.

# Safety Warnings



The exclamation point within a triangle is intended to warn the operator or service personnel of operation and maintenance factors relating to the product and its operating environment which could pose a safety hazard.

Always observe standard safety precautions during installation, operation and maintenance of this product. Only qualified and authorized service personnel should carry out adjustment, maintenance or repairs to this instrument. No adjustment, maintenance or repairs should be performed by either the operator or the user.

## Telecommunication Safety

The safety status of each of the ports on the AMC-101 is declared according to EN 41003 and is detailed in the table below:

Safety Status	Ports
SELV*	V.11, V.24, V.35, V.36, X.21, X.50, LAN
TNV**	FXO, FXS, E&M
TNV operating within the limits of SELV	ISDN, E1, T1, sub E1, sub T1, various outputs to modem
Limited current	None
ELV***	None
Excessive voltage	None

- \* SELV = Safety Extra-Low Voltage
- \*\* TNV = Telecommunications Network Voltage
- \*\*\* ELV = Extra-Low Voltage

# Regulatory Information

## FCC-15 User Information

This equipment has been tested and found to comply with the limits of the Class A digital device, pursuant to Part 15 of the FCC rules. These limits are designed to provide reasonable protection against harmful interference when the equipment is operated in a commercial environment. This equipment generates, uses and can radiate radio frequency energy and, if not installed and used in accordance with the instruction manual, may cause harmful interference to the radio communications. Operation of this equipment in a residential area is likely to cause harmful interference in which case the user will be required to correct the interference at his own expense.

## Warning per EN 55022

This is a Class A product. In a domestic environment, this product may cause radio interference, in which case the user may be required to take adequate measures.

# Declaration of Conformity

**Manufacturer's Name:** RAD Data Communications Ltd.

**Manufacturer's Address:** 12 Hanechoshet St.  
Tel Aviv 69710  
Israel

**declares that the product:**

**Product Name:** **AMC-101**

Conforms to the following standard(s) or other normative document(s):

<b>EMC:</b>	EN 55022 (1994)	Limits and methods of measurement of radio disturbance characteristics of information technology equipment.
	EN 50082-1 (1992)	Electromagnetic compatibility - Generic immunity standards for residential, commercial and light industry.
<b>Safety:</b>	EN 60950 (1992/93)	Safety of information technology equipment, including electrical business equipment.

## Supplementary Information:

The product herewith complies with the requirements of the EMC Directive 89/336/EEC and the Low Voltage Directive 73/23/EEC. The product was tested in a typical configuration.

Tel Aviv, October 10th, 1996



Haim Karshen  
VP Quality

**European Contact:** RAD Data Communications GmbH, Lyoner Strasse 14, 60528 Frankfurt am Main, Germany

# Contents

## CHAPTER 1 – INTRODUCTION

<b>1.1 General</b> .....	<b>1-1</b>
Retimed Modules .....	1-1
Transparent Modules .....	1-1
<b>1.2 Features</b> .....	<b>1-2</b>
<b>1.3 General Applications</b> .....	<b>1-3</b>
<b>1.4 Fast Ethernet Applications</b> .....	<b>1-6</b>
<b>1.5 Specifications</b> .....	<b>1-10</b>
Indicators .....	1-10
Controls.....	1-10
Power.....	1-10
Physical .....	1-10
Environment .....	1-10

## CHAPTER 2 – INSTALLATION & SETUP

<b>2.1 Unpacking</b> .....	<b>2-1</b>
Before Unpacking.....	2-1
Unpacking Procedure .....	2-1
<b>2.2 Site Requirements</b> .....	<b>2-1</b>
Power.....	2-1
Front and Rear Panel Clearance .....	2-1
Ambient Requirements .....	2-1
Installation of a Single Unit.....	2-2
Installation of Two Units .....	2-3
<b>2.3 Cable Connections</b> .....	<b>2-4</b>
AC Power Connection .....	2-4
Grounding.....	2-4
<b>2.4 AMC-101 Modules</b> .....	<b>2-5</b>
MM/SC/13/R Module.....	2-5
MM/SC/13/T Module .....	2-6
MM/ST/13/R Module .....	2-7
MM/ST/13/T Module .....	2-8
SM/ST/13/R Module.....	2-9
SM/ST/13/T Module.....	2-10
SM/FC/13/T Module .....	2-11
SM/ST/13L/R Module.....	2-12
SM/ST/13L/T Module .....	2-13
SM/SC/13L/R Module .....	2-14

SM/ST/13LH/R Module .....	2-15
SM/FC/13LH/R Module.....	2-16
SM/ST/15L/R Module .....	2-17
SM/ST/15LH/R Module .....	2-18
SM/FC/15LH/R Module.....	2-19
MM/ST/85/T Module .....	2-20
SF1/ST/R Module .....	2-21
SF2/ST/R Module .....	2-22
SF1/FC/R Module.....	2-23
SF2/FC/R Module.....	2-24
CX/BNC/155/R Module.....	2-25
CX/DIN/155/R Module .....	2-26
STP/155/R Module.....	2-27
STP/155/T Module.....	2-28
UTP/155/R Module.....	2-29
UTP/155/T Module.....	2-30
UTP/100/R Module.....	2-31
UTP/100/T Module.....	2-32
100BT/B Module .....	2-33
100BT/R Module .....	2-34
10BT/B Module .....	2-35

## CHAPTER 3 – OPERATION

<b>3.1 Controls and Indicators .....</b>	<b>3-1</b>
<b>3.2 Dry Contact Circuit and Connector for Alarms.....</b>	<b>3-3</b>
<b>3.3 Turning On AMC-101 .....</b>	<b>3-4</b>
<b>3.4 Normal Operation .....</b>	<b>3-5</b>
<b>3.5 Turning Off AMC-101 .....</b>	<b>3-5</b>
<b>3.6 Troubleshooting Procedures .....</b>	<b>3-5</b>
The POWER LED does not light .....	3-5
Data transmission difficulties .....	3-5



## List of Figures

Figure 1-1	Dissimilar Device Connectivity .....	1-3
Figure 1-2	Dual Similar Device Connectivity.....	1-3
Figure 1-3	WRAP: Dual Single Mode (SM) to Multimode (MM) Conversion .....	1-4
Figure 1-4	Single Interface SM to MM (Wrap).....	1-4
Figure 1-5	FDDI and Fast Ethernet Operations.....	1-5
Figure 1-6	Half Duplex Point-to-Point Connection.....	1-6
Figure 1-7	Extending Half Duplex Point-to-Point Connection .....	1-6
Figure 1-8	Repeater Half Duplex Connection over UTP .....	1-7
Figure 1-9	Extending Repeater Half Duplex Connection .....	1-7
Figure 1-10	Point-to-Point Full Duplex Connection.....	1-8
Figure 1-11	Extending Point-to-Point Full Duplex Connection.....	1-8
Figure 1-12	Full Duplex Connection over UTP.....	1-9
Figure 1-13	Extending Full Duplex Connection .....	1-9
Figure 2-1	AMC-101 Rear Panel AC Version.....	2-2
Figure 2-2	AMC-101 Rear Panel DC Version .....	2-2
Figure 2-3	Installation of a Single Unit .....	2-2
Figure 2-4	Installation of Two Units (a) .....	2-3
Figure 2-5	Installation of Two Units (b) .....	2-4
Figure 2-6	MM/SC/13/R Module Front Panel .....	2-5
Figure 2-7	MM/SC/13/T Module Front Panel .....	2-6
Figure 2-8	MM/ST/13/R Module Front Panel.....	2-7
Figure 2-9	MM/ST/13/T Module Front Panel.....	2-8
Figure 2-10	SM/ST/13/R Module Front Panel .....	2-9
Figure 2-11	SM/ST/13/T Module Front Panel .....	2-10
Figure 2-12	SM/FC/13/T Module Front Panel.....	2-11
Figure 2-13	SM/ST/13L/R Module Front Panel .....	2-12
Figure 2-14	SM/ST/13L/T Module Front Panel .....	2-13
Figure 2-15	SM/SC/13L/R Module Front Panel.....	2-14
Figure 2-16	SM/ST/13LH/R Module Front Panel .....	2-15
Figure 2-17	SM/FC/13LH/R Module Front Panel.....	2-16
Figure 2-18	SM/ST/15L/R Module Front Panel .....	2-17
Figure 2-19	SM/ST/15LH/R Module Front Panel .....	2-18
Figure 2-20	SM/FC/15LH/R Module Front Panel .....	2-19
Figure 2-21	MM/ST/85/T Module Front Panel.....	2-20
Figure 2-22	SF1/ST/R Module Front Panel .....	2-21
Figure 2-23	SF2/ST/R Module Front Panel .....	2-22
Figure 2-24	SF1/FC/R Module Front Panel .....	2-23
Figure 2-25	SF2/FC/R Module Front Panel .....	2-24
Figure 2-26	CX/BNC/155/R Module Front Panel .....	2-25
Figure 2-27	CX/DIN/155/R Module Front Panel.....	2-26
Figure 2-28	STP/155/R Module Front Panel .....	2-27
Figure 2-29	STP/155/T Module Front Panel .....	2-28
Figure 2-30	UTP/155/R Module Front Panel.....	2-29
Figure 2-31	UTP/155/T Module Front Panel .....	2-30
Figure 2-32	UTP/100/R Module Front Panel .....	2-31
Figure 2-33	UTP/100/T Module Front Panel .....	2-32
Figure 2-34	100BT/B Module Front Panel.....	2-33
Figure 2-35	100BT/R Module Front Panel.....	2-34

Figure 2-36 10BT/B Module Front Panel..... 2-35  
Figure 3-1 AMC-101 Front Panel..... 3-1  
Figure 3-2 Jumper Locations and Functions ..... 3-2  
Figure 3-3 Connector Pin Assignment..... 3-3  
Figure 3-4 AMC-101 Block Diagram..... 3-4

## List of Tables

Table 1-1 Optical Module Characteristics ..... 1-11  
Table 1-2 Electrical Module Characteristics ..... 1-13  
Table 1-3 Bridging Modules ..... 1-13  
Table 2-1 STP/155/R Pinout ..... 2-27  
Table 2-2 STP/155/T Pinout ..... 2-28  
Table 2-3 UTP/155/R Pinout ..... 2-29  
Table 2-4 UTP/155/T Pinout ..... 2-30  
Table 2-5 UTP/100/R Pinout ..... 2-31  
Table 2-6 UTP/100/T Pinout ..... 2-32  
Table 2-7 100BT/B Module Pinout ..... 2-33  
Table 2-8 100BT/R Module Pinout ..... 2-34  
Table 2-9 10BT/B Module Pinout ..... 2-35  
Table 3-1 AMC-101 Front Panel Indicators ..... 3-1  
Table 3-2 AMC-101 Front Panel Controls ..... 3-1  
Table 3-3 Functions and Settings ..... 3-2  
Table 3-4 Connector Pin Assignment ..... 3-3

# Chapter 1

---

## Introduction

---

### 1.1 General

The AMC-101, a Universal Converter and Repeater, provides retimed or transparent conversion of optical and electrical signals for ATM, FDDI, Fast Ethernet and other protocols at data rates up to 155 Mbps. The modularity of the AMC-101 interfaces enables field-changeable conversion between any two media.

Transparent modules provide cost-effective media conversion without reclocking. Retimed modules provide media conversion with reclocking, which enables the AMC-101 to be used as a repeater. These modules can also be set for transparent operation.

AMC-101 is supplied as a standalone unit. Special hardware for mounting either a single unit or two units side-by-side in a 19" rack can be ordered separately.

**Retimed Modules** The AMC-101 provides retimed media conversion for the following ATM interfaces:

- TAXI (100 Mbps)
- STM-1
- STS-3c
- STS-1 over optical and electrical interfaces.

Retimed conversion is also available for FDDI and Fast Ethernet between single mode and multimode fiber, and for extending FDDI UTP connections over fiber. The retimed modules provide rate selection for 51, 100 or 155 Mbps. When set to one of these rates, the retimed module regenerates and reclocks the incoming signal and acts as an ATM or FDDI repeater. When the switch is set to "OTHER", the modules regenerate the signal without reclocking as transparent modules do.

**Transparent Modules**

The AMC-101 provides transparent conversion for any two-level optical protocol. Transparent modules are recommended for short distances and for all fiber and copper applications at less than 100 Mbps.

A special WRAP button activates loopbacks at the two interfaces. This can be used for test purposes or for special applications as explained later.

## 1.2 Features

Modular Media Converter and Repeater, Media types supported:

- Single Mode Fiber
- Multimode Fiber
- STP
- UTP
- Coax

Retimed media conversion for 51 Mbps, 100 Mbps and 155 Mbps.

Transparent media conversion up to 155 Mbps.

In retimed mode can be used as a Fiber Optic or copper repeater

Protocols supported in retimed mode:

- 51 Mbps OC-1
- 100 Mbps TAXI
- 155 Mbps OC-3
- 155 Mbps STS-3c over UTP/STP
- 155 Mbps STS-3c/STM-1 over Coax
- FDDI
- 100BaseT (Fast Ethernet).

Transparent mode supports any two-level optical protocol including:

- Ethernet
- Token Ring
- Protocols supported in retimed mode (fiber and copper) performed at less than 100 Mbps.

Complies with ATM forum specifications.

Multiple connector types are available for both electrical and optical interfaces.

### 1.3 General Applications

A single AMC-101 is used to connect two devices operating with different fiber or electrical interfaces (see *Figure 1-1*).

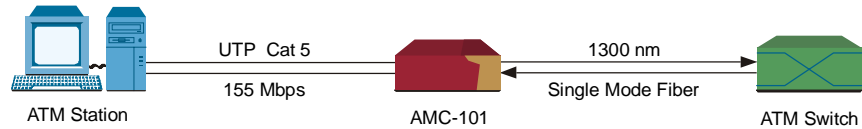

*Figure 1-1 Dissimilar Device Connectivity*

A pair of AMC-101s connect two similar devices over different media types (see *Figure 1-2*).

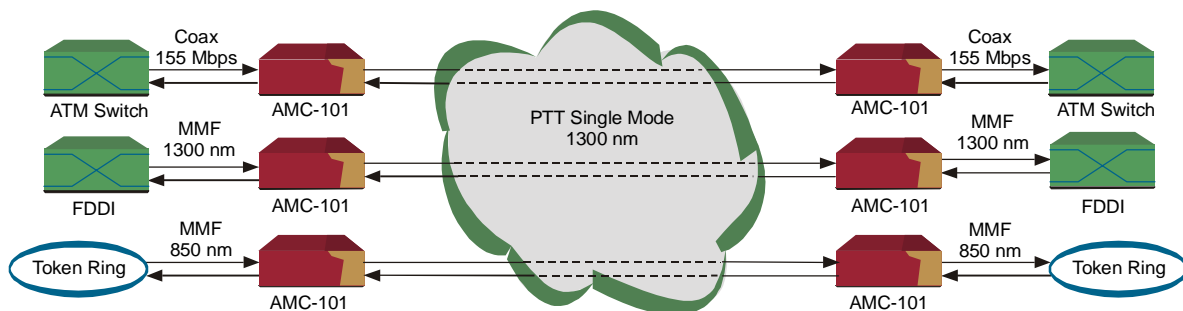

*Figure 1-2 Dual Similar Device Connectivity*

A single AMC-101 in WRAP mode can be used for double conversion between single mode and multimode fiber for a dual attached FDDI station or concentrator (see *Figure 1-3*).

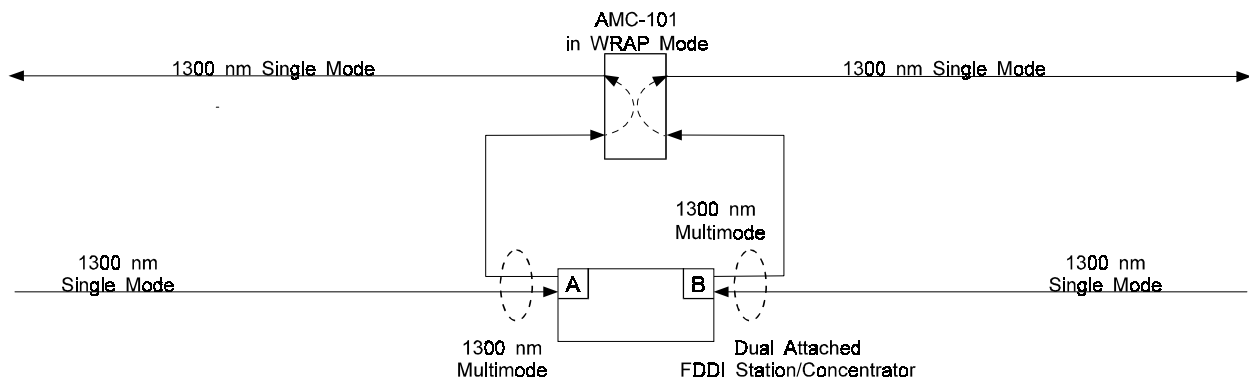

*Figure 1-3 WRAP: Dual Single Mode (SM) to Multimode (MM) Conversion*

A single AMC-101 equipped with a single interface in WRAP mode can be used for conversion between single mode and multimode fiber (see *Figure 1-4*).

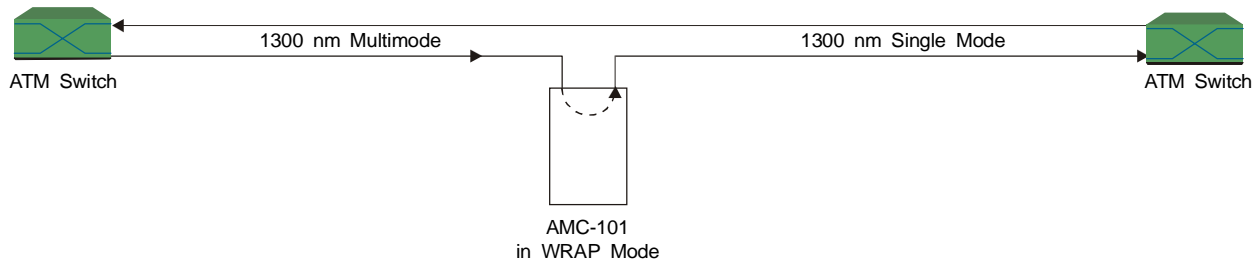

*Figure 1-4 Single Interface SM to MM (Wrap)*

The FDDI applies scrambling to data when operating over UTP, but not doing so when operating over fiber. Because of this, AMC-101 can only work in pairs for extending FDDI connections over fiber (see *Figure 1-5*).

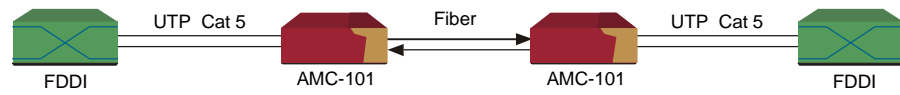

*Figure 1-5 FDDI and Fast Ethernet Operations*

## 1.4 Fast Ethernet Applications

- Point to Point Link using a pair of Fiber Optic Cables running in HD (Half Duplex) 100-BaseFX:

### Problem:

In a point to point application, in HD, the maximum range is limited to 412m.

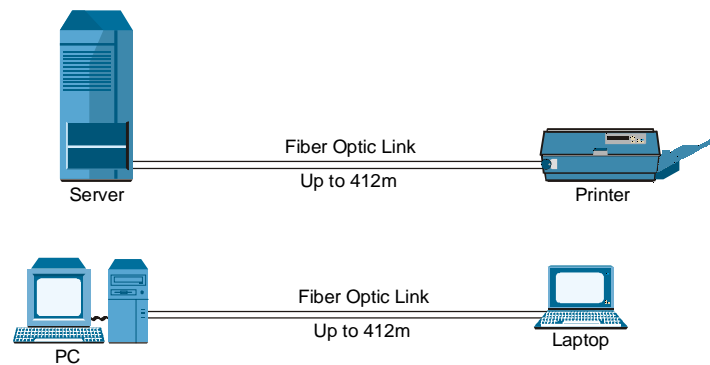

Figure 1-6 Half Duplex Point-to-Point Connection

### Solution:

Using two AMC-M/100BT/B modules can extend the range up to tens of kilometers.

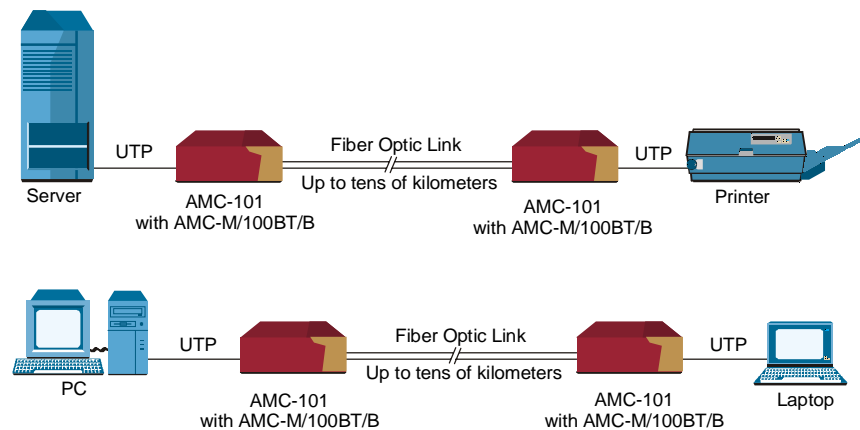

Figure 1-7 Extending Half Duplex Point-to-Point Connection



- Repeater based LAN Link using standard UTP at HD (Half Duplex).

**Problem:**

Range is limited to 100m from the repeater.

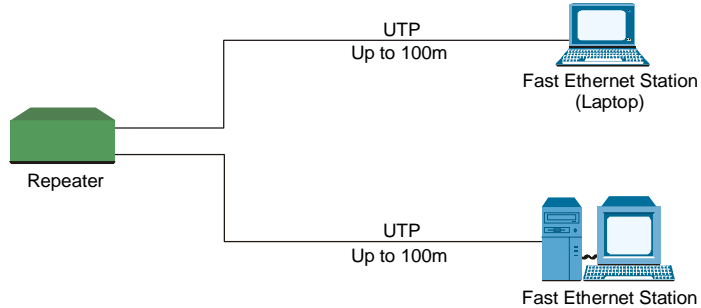

Figure 1-8 Repeater Half Duplex Connection over UTP

**Solution:**

Using two AMC-101s with AMC-M/100BT/B modules can extend the range up to tens of kilometers.

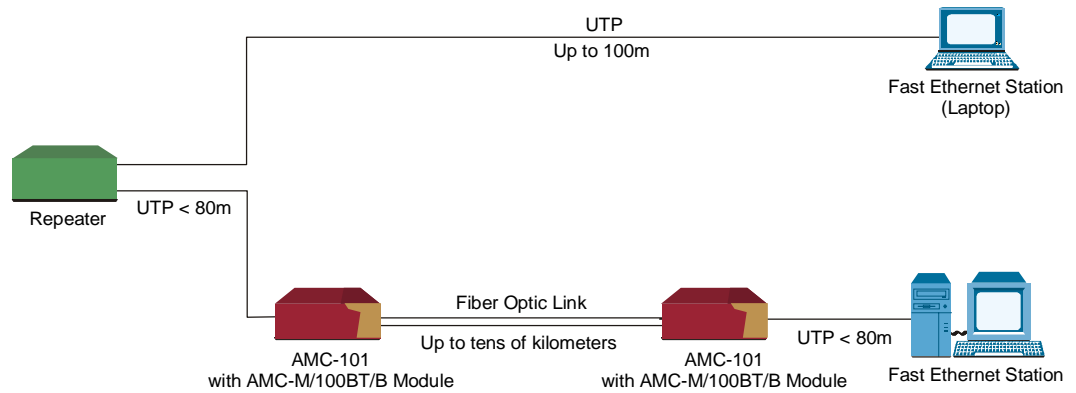
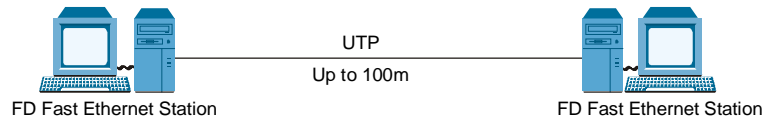

Figure 1-9 Extending Repeater Half Duplex Connection

- Extension of a point to point FD (Full Duplex) Fast Ethernet connection:

**Problem:**

The distance between two FD stations running on UTP needs to be extended.



*Figure 1-10 Point-to-Point Full Duplex Connection*

**Solution:**

Using two AMC-101s with AMC-M/100BT/R modules can extend the range up to tens of kilometers.

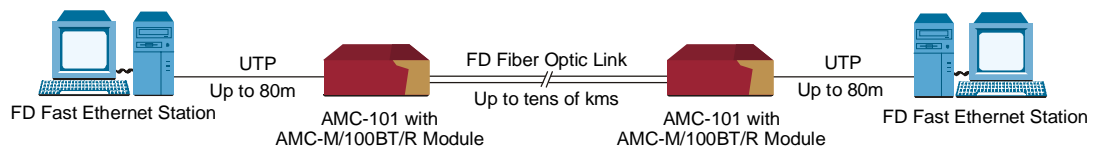

*Figure 1-11 Extending Point-to-Point Full Duplex Connection*

- Extension of a Switched Based Fast Ethernet LAN (FD - Full Duplex)

**Problem:**

The range of a FD Fast Ethernet LAN running on UTP has to be extended.

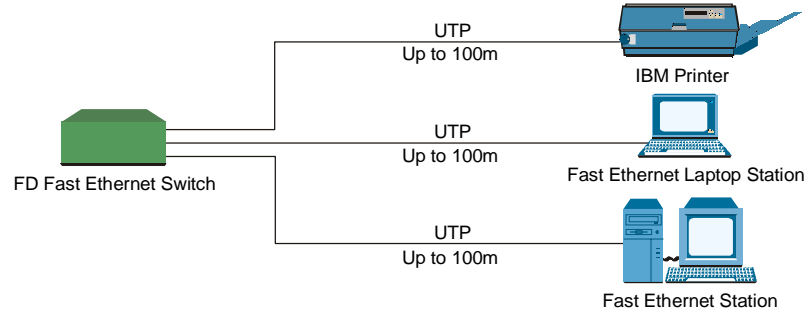

Figure 1-12 Full Duplex Connection over UTP

**Solution:**

Using AMC-101s with AMC-M/100BT/R modules can extend the range up to tens of kilometers.

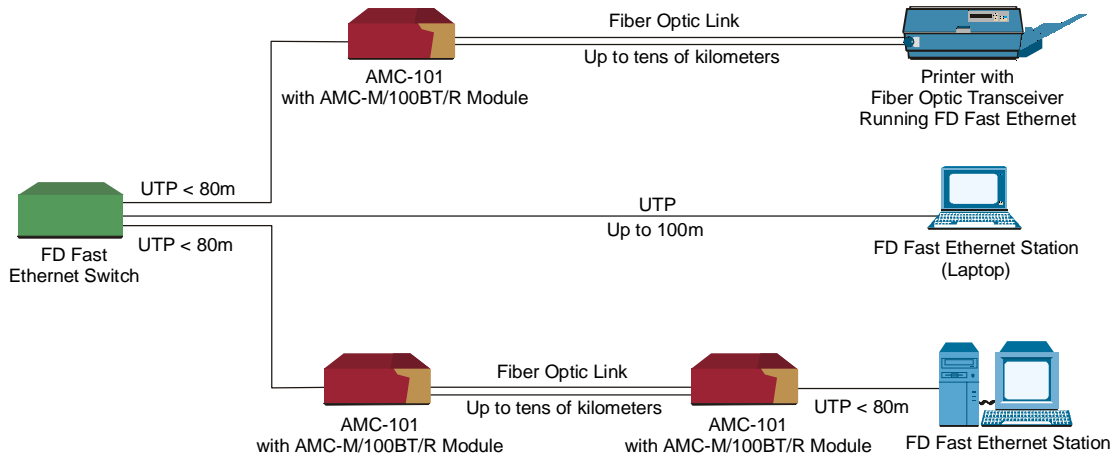

Figure 1-13 Extending Full Duplex Connection

---



---

## 1.5 Specifications

<b>Indicators</b>	<i>Data Rate</i>	Up to 155 Mbps
	<i>POWER (PWR)</i>	ON when unit is powered
	<i>FAULT (FLT)</i>	BLINKS when card configuration is wrong
	<i>WRAP</i>	ON when the two interfaces are wrapped
<b>Controls</b>	<i>SIG</i>	ON when received signal from Rx is valid BLINKS when the PLL is out of lock
	<i>WRAP</i>	For double conversion or test purposes
	<i>RATE</i>	For data rate selection 51, 100, 155 Mbps
<b>Power</b>	<i>OTHER</i>	For transparent mode
	<i>AC source</i>	90-260 VAC, 16 ± 0.4 Watts, 47-63 Hz
<b>Physical</b>	<i>DC source</i>	-48 VDC
	<i>Height</i>	4.4 cm / 1.8 in (1U)
	<i>Width</i>	21.6 cm / 8.5 in
	<i>Depth</i>	24.2 cm / 9.5 in
<b>Environment</b>	<i>Weight</i>	1.1 kg / 2.8 lb
	<i>Temperature</i>	0°-50°C/32°-122°F
	<i>Humidity</i>	Up to 95%, non-condensing

Table 1-1 Optical Module Characteristics

Module Name	Protocols Supported	Fiber Type (Wavelength)	Connector Type	Typical Distance	Dynamic Range	Optical Power (Typical)	Sensitivity
MM/ST/85*	Token Ring, Ethernet only	62.5/125 (850 nm)	ST	2 Km / 1.2 mile	18 dB	-18 dBm	-30 dBm
MM/SC/13**	TAXI, FDDI, Fast Ethernet, STS-1, STS-3c/STM-1	62.5/125 (1300 nm)	SC	2 Km / 1.2 mile	17 dB	-18 dBm	-31 dBm
MM/ST/13**	TAXI, FDDI, Fast Ethernet STS-3c/STM-1, STS-1	62.5/125 (1300 nm)	ST	2 Km / 1.2 mile	17 dB	-18 dBm	-31 dBm
SF1/FC***	TAXI, FDDI, Fast Ethernet, STS-3c/STM-1, STS-1	9/125 Transmit 1300 nm Receive 1550 nm	FC-PC (Single Strand)	40 Km / 24.8 mile	28 dB	-12 dBm	-29 dBm
SF2/FC***	TAXI, FDDI, Fast Ethernet, STS-3c/STM-1, STS-1	9/125 Transmit 1550 nm Receive 1300 nm	FC-PC (Single Strand)	40 Km / 24.8 mile	28 dB	-12 dBm	-29 dBm
SF1/ST***	TAXI, FDDI, Fast Ethernet, STS-3c/STM-1, STS-1	9/125 Transmit 1300 nm Receive 1550 nm	ST (Single Strand)	40 Km / 24.8 mile	28 dB	-12 dBm	-29 dBm
SF2/ST***	TAXI, FDDI, Fast Ethernet, STS-3c/STM-1, STS-1	9/125 Transmit 1550 nm Receive 1300 nm	ST (Single Strand)	40 Km / 24.8 mile	28 dB	-12 dBm	-29 dBm
SM/FC/13**	TAXI, FDDI, Fast Ethernet, STS-3c/STM-1/ STS-1	9/125 1300 nm	FC-PC	25 Km / 15.5 mile	30 dB	-15 dBm	-31 dBm
SM/FC/13L** (LASER)	TAXI, FDDI, Fast Ethernet, STS-3c/STM-1/ STS-1	9/125 1300 nm	FC-P	40 Km / 24.8 mile	30 dB	-12 dBm	-31 dBm

Table 1-1 Optical Module Characteristics (Cont.)

Module Name	Protocols Supported	Fiber Type (Wavelength)	Connector Type	Typical Distance	Dynamic Range	Optical Power (Typical)	Sensitivity
SM/FC/13LH*** (LASER)	TAXI, FDDI, Fast Ethernet STS-3c/STM-1, STS-1	9/125 (1300 nm)	FC-PC	60 Km / 37.2 mile	33 dB	-2 dBm	-34 dBm
SM/FC/15LH*** (LASER)	TAXI, FDDI, Fast Ethernet STS-3c/STM-1, STS-1	9/125 (1550 nm)	FC-PC	110 Km / 68.2 mile	33 dB	-2 dBm	-34 dBm
SM/SC/13L** (LASER)	TAXI, FDDI, Fast Ethernet, STS-3c/STM-1, STS-1	9/125 (1300 nm)	SC	40 Km / 24.8 mile	30 dB	-12 dBm	-31 dBm
SM/ST/13**	TAXI, FDDI, Fast Ethernet, STS-3c/STM-1, STS-1	9/125 (1300 nm)	ST	25 Km / 15.5 mile	30 dB	-15 dBm	-31 dBm
SM/ST/13L** (LASER)	TAXI, FDDI, Fast Ethernet, STS-3c/STM-1, STS-1	9/125 (1300 nm)	ST	40 Km / 24.8 mile	30 dB	-12 dBm	-31 dBm
SM/ST/13LH*** (LASER)	TAXI, FDDI, Fast Ethernet, STS-3c/STM-1, STS-1	9/125 (1300 nm)	ST	60 Km / 37.2 mile	33 dB	-2 dBm	-34 dBm
SM/ST/15L** (LASER)	TAXI, FDDI, Fast Ethernet, STS-3c/STM-1, STS-1	9/125 (1500 nm)	ST	50 Km / 31 mile	30 dB	-12 dBm	-31 dBm
SM/ST/15LH*** (LASER)	TAXI, FDDI, Fast Ethernet, STS-3c/STM-1, STS-1	9/125 (1550 nm)	ST	110 Km / 68.2 mile	33 dB	-2 dBm	-34 dBm

\* Data Rates are switch-selectable from the front panel

\*\* Transparent only

\*\*\* Retimed only

**Note** *Typical distances based on attenuation of 0.4 dB/Km for 1300 nm modules and 0.25 dB/Km for 1550 nm modules*

*Table 1-2 Electrical Module Characteristics*

Module Name	Protocols Supported	Cable Type	Connector Type	Range	Impedance (Ohms)
UTP/155*	STS-3c	UTP Cat 5	Shielded RJ-45	100 m	100
STP/155*	STS-3c	STP Type 1	DB-9	100 m	150
UTP/100*	FDDI,	UTP Cat 5	Shielded RJ-45	100 m	100
CX/BNC/155**	STS-3c STM-1	Coax	BNC	12.7 dB*	75
CX/DIN/155**	STS-3c STM-1	Coax	DIN 47295 1.6/5.6 Coaxial connector	12.7 dB*	75

\* 50 m in transparent module

\*\* Retimed only, 135 m is attainable when using RG-59 B/U cable (At 78 MHz, according to square root of frequency law)

*Table 1-3 Bridging Modules*

Module Name	Protocols Supported	Cable Type	Connector Type	Range	Impedance (Ohms)
10BT/B*	Ethernet	UTP Cat 5	Shielded RJ-45	100 m	100
100BT/B**	Fast Ethernet	UTP Cat 5	Shielded RJ-45	80 m	100
100BT/R***	Fast Ethernet	UTP Cat 5	Shielded RJ-45	80 m	100

\* Remote Ethernet bridge module

\*\* Remote Fast Ethernet bridge module

\*\*\* Media Converter for Fast Ethernet (Tx to Fx)





# Chapter 2

---

## Installation & Setup

---

---

### 2.1 Unpacking

- Before Unpacking** Inspect the equipment container before unpacking. Note and report evidence of damage immediately.
- Unpacking Procedure**
- Place the container on a clean flat surface. Cut all straps and open or remove top.
  - Remove the unit carefully and place it securely on a clean surface.
  - Remove all packing material.
  - Inspect the unit for damage. Report any damage immediately.

---

### 2.2 Site Requirements

- Power** AMC-101 is powered by 100 to 240 VAC or -48 VDC.
- The unit should be installed within 1.5m (5 ft) of an easily accessible grounded AC outlet capable of supplying 230 V (115 V).
- Front and Rear Panel Clearance** Allow at least 90 cm (36 in) of clearance at the front of the unit for operator access. Allow at least 10 cm (4 in) clearance at the rear of the unit for power cord connection.
- Ambient Requirements** The ambient operating temperature of AMC-101 should be 0-40°C (32-122°F) at a relative humidity of up to 90%, non-condensing.

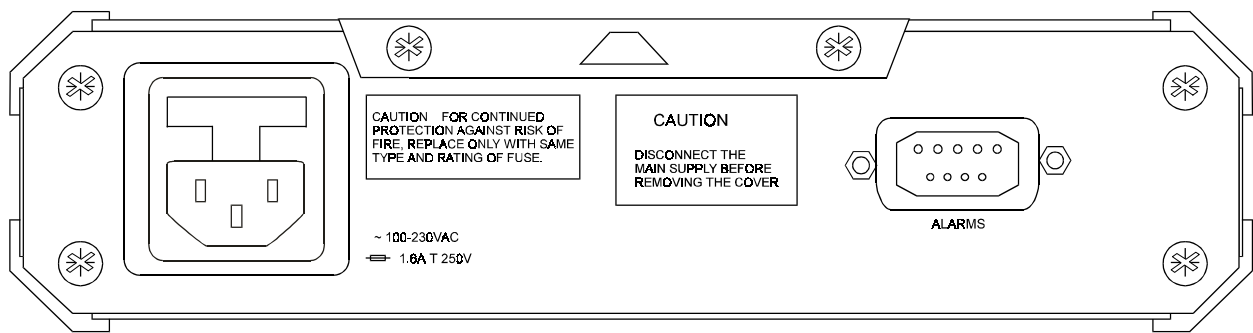

Figure 2-1 AMC-101 Rear Panel AC Version

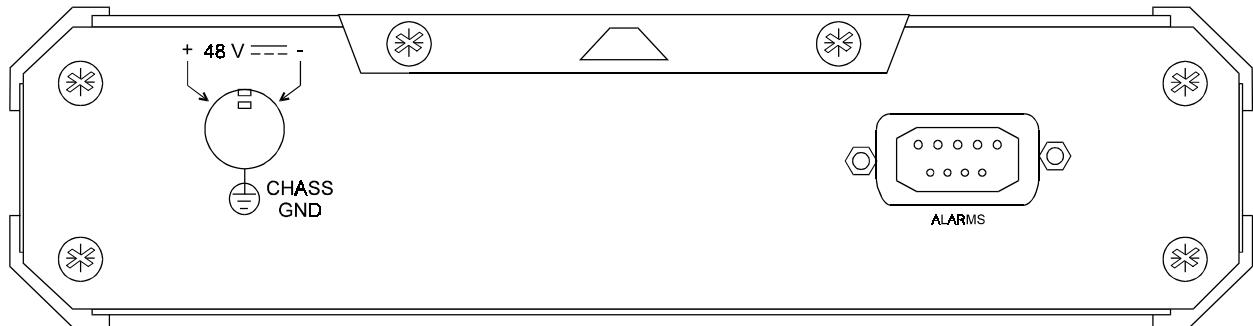

Figure 2-2 AMC-101 Rear Panel DC Version

### Installation of a Single Unit

Rack adapter components for installing a single unit include one short bracket and one long bracket. Each bracket is fastened to the side walls of the unit by two screws (with flat washers) which are inserted into the two front holes on the side wall (The unit is supplied with nuts already in place on the inner side wall). Note that the short bracket fastens to the left side of the unit, and the long bracket to the right side of the unit (see *Figure 2-3*).

Once the brackets are fastened to the side walls, the unit is ready for installation in the 19" rack. Place the unit in the rack and fasten the brackets to the side rails of the rack by means of the two screws situated on each side (not included in the kit).

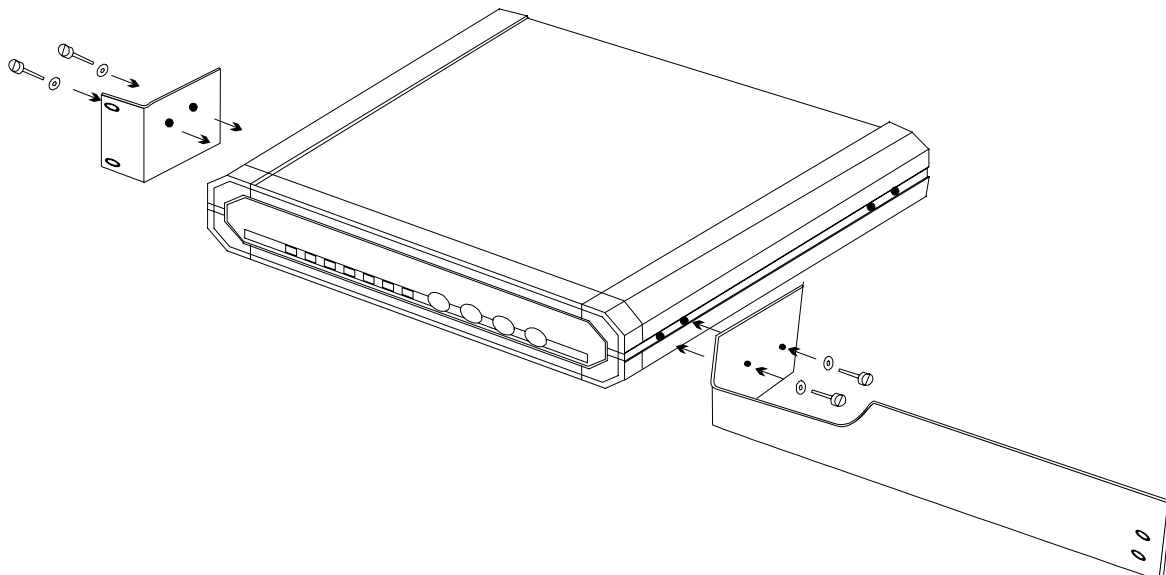
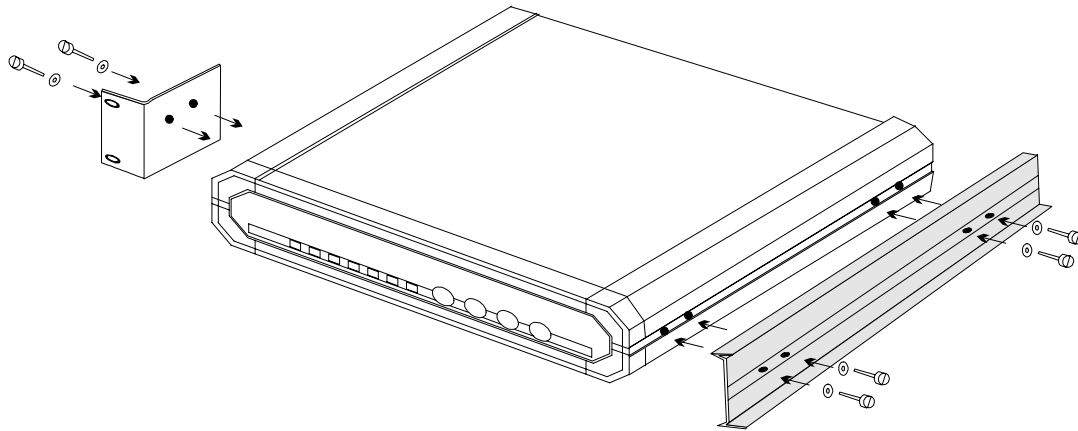

Figure 2-3 Installation of a Single Unit

## Installation of Two Units

Rack adapter components for installing two units include two long side rails (one for each unit) which slide one into the other fastening the two units together, and two short side brackets which hold the two units in the 19" rack (see *Figure 2-4*).



*Figure 2-4 Installation of Two Units (a)*

To install two units follow these instructions:

1. Fasten one long side rail to each unit (right side to one unit, left side to the other unit) using the four screws and flat washers supplied. The side rails must be attached in opposing fashion, the narrow flange of the first rail opposite the wide flange of the second rail.
2. Attach one short bracket opposite the side rail on each unit using the four screws and flat washers supplied.
3. Slide the side rail of one unit into the side rail of the other unit, fastening the two units together (see *Figure 2-5*).
4. Secure the supplied plastic caps to the ends of the rails, to prevent the units moving and to protect the rail ends.
5. Place the assembled units in the rack and fasten the brackets to the side rails of the rack, by means of the four screws situated on each side (not included in the kit).

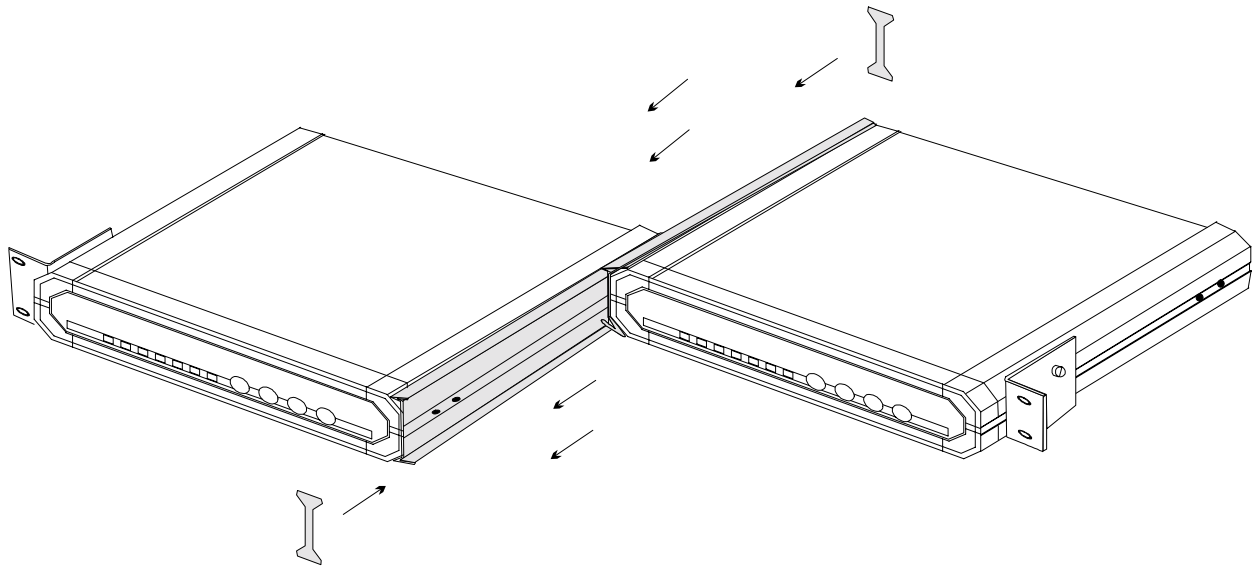

Figure 2-5 Installation of Two Units (b)

---

## 2.3 Cable Connections

### AC Power Connection

AC power should be supplied to AMC-101 through a 1.5m (5 ft) standard power cord terminated by a grounded 3-wire plug.



When applying AC power, first connect the plug of the AC cable to the power connector on the rear panel of AMC-101 and then to the mains outlet.

---

### Grounding



Interrupting of the protective (grounding) conductor (inside or outside the instrument) or disconnecting the protective earth terminal can make this instrument dangerous. Intentional interruption of the grounding conductor is prohibited.

---

## 2.4 AMC-101 Modules

The upper part of the module front panel is AMC-R for a Retimed Timing mode; the lower part is AMC-T for a Transparent Timing mode. In both panels, the module name is labeled at panel's bottom.

### MM/SC/13/R Module

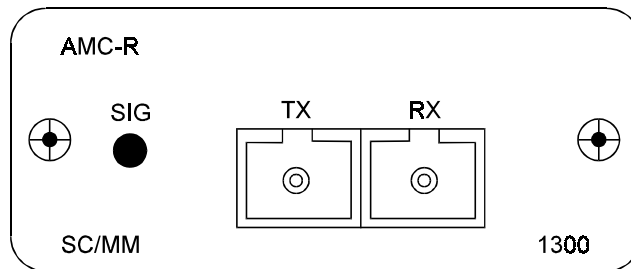
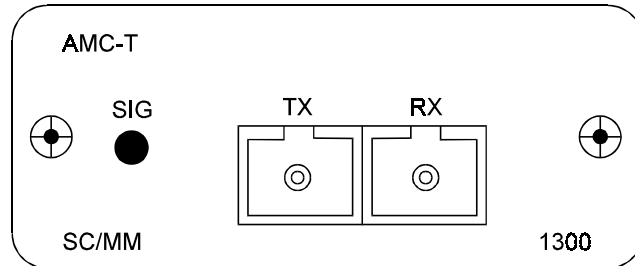

Figure 2-6 MM/SC/13/R Module Front Panel

Wavelength:	1300 nm
Connector:	SC
Used with:	Multimode fiber
Protocols supported:	STS-3c, STM-1, STS-1, FDDI, TAXI and Fast Ethernet
Timing mode:	Retimed
Coding method:	4B/5B, NRZ
Optical output into 62.5/125 fiber:	-18 dBm
Receiver sensitivity:	-31 dBm
Maximum input power:	-14 dBm

**MM/SC/13/T Module**

*Figure 2-7 MM/SC/13/T Module Front Panel*

Wavelength:	1300 nm
Connector:	SC
Used with:	Multimode fiber
Protocols supported:	Any two level optical protocols up to 155 Mbps
Timing mode:	Transparent
Coding method:	4B/5B, NRZ
Optical output into 62.5/125 fiber:	-18 dBm
Receiver sensitivity:	-31 dBm
Maximum input power:	-14 dBm

## MM/ST/13/R Module

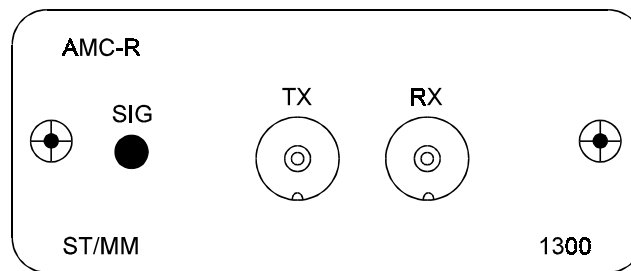

Figure 2-8 MM/ST/13/R Module Front Panel

Wavelength:	1300 nm
Connector:	ST
Used with:	Multimode fiber
Protocols supported:	STS-3c, STM-1, STS-1, FDDI, TAXI and Fast Ethernet
Timing mode:	Retimed
Coding method:	4B/5B, NRZ
Optical output into 62.5/125 fiber:	-18 dBm
Receiver sensitivity:	-31 dBm
Maximum input power:	-14 dBm

## MM/ST/13/T Module

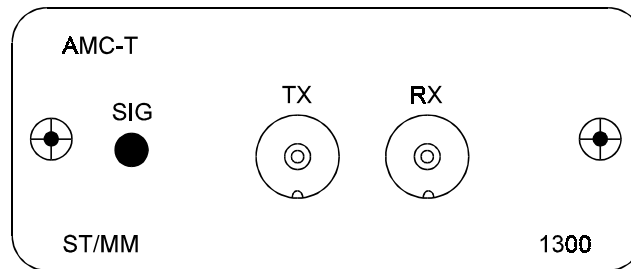

Figure 2-9 MM/ST/13/T Module Front Panel

Wavelength:	1300 nm
Connector:	ST
Used with:	Multimode fiber
Protocols supported:	Any two level optical protocols up to 155 Mbps
Timing mode:	Transparent
Coding method:	4B/5B, NRZ
Optical output into 62.5/125 fiber:	-18 dBm
Receiver sensitivity:	-31 dBm
Maximum input power:	-14 dBm



## SM/ST/13/R Module

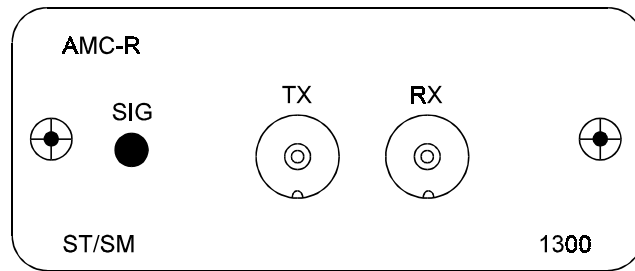

Figure 2-10 SM/ST/13/R Module Front Panel

Wavelength:	1300 nm
Connector:	ST
Used with:	Single mode fiber
Protocols supported:	STS-3c, STM-1, STS-1, FDDI, TAXI and Fast Ethernet
Timing mode:	Retimed
Coding method:	4B/5B, NRZ
Optical output into 9/125 fiber:	-15 dBm
Receiver sensitivity:	-31 dBm
Maximum input power:	-1 dBm

## SM/ST/13/T Module

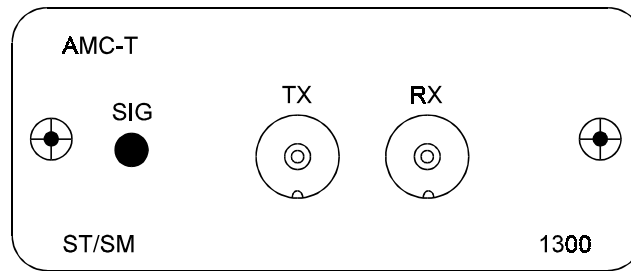

Figure 2-11 SM/ST/13/T Module Front Panel

Wavelength:	1300 nm
Connector:	ST
Used with:	Single mode fiber
Protocols supported:	Any two level optical protocols up to 155 Mbps
Timing mode:	Transparent
Coding method:	4B/5B, NRZ
Optical output into 9/125 fiber:	-15 dBm
Receiver sensitivity:	-31 dBm
Maximum input power:	-1 dBm

## SM/FC/13/T Module

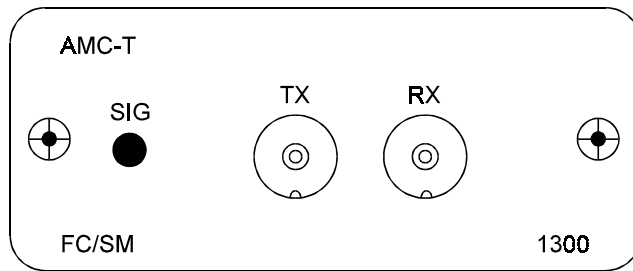
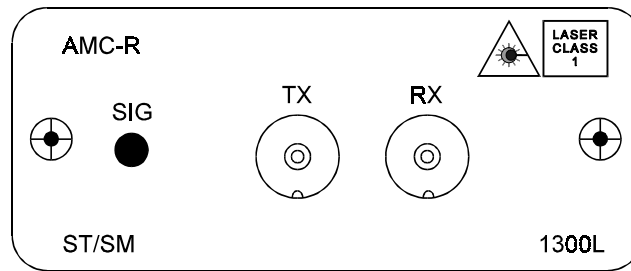

Figure 2-12 SM/FC/13/T Module Front Panel

Wavelength:	1300 nm
Connector:	FC
Used with:	Single mode fiber
Protocols supported:	Any two level optical protocols up to 155 Mbps
Timing mode:	Transparent
Coding method:	4B/5B, NRZ
Optical output into 9/125 fiber:	-15 dBm
Receiver sensitivity:	-31 dBm
Maximum input power:	-1 dBm

**SM/ST/13L/R Module***Figure 2-13 SM/ST/13L/R Module Front Panel*

Wavelength:	1300 nm
Connector:	ST
Used with:	Single mode fiber
Protocols supported:	STS-3c, STM-1, STS-1, FDDI, TAXI and Fast Ethernet
Timing mode:	Retimed
Coding method:	4B/5B, NRZ
Optical output into 9/125 fiber:	-12 dBm
Receiver sensitivity:	-31 dBm
Maximum input power:	-1 dBm

## SM/ST/13L/T Module

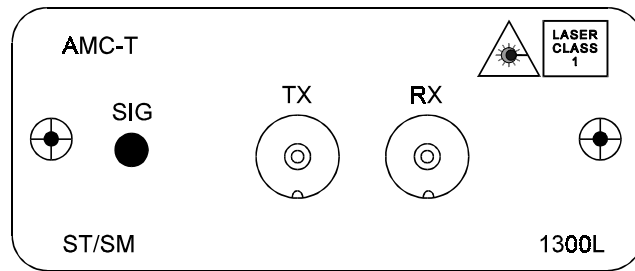

Figure 2-14 SM/ST/13L/T Module Front Panel

Wavelength:	1300 nm
Connector:	ST
Used with:	Single mode fiber
Protocols supported:	Any two level optical protocols up to 155 Mbps
Timing mode:	Transparent
Coding method:	4B/5B, NRZ
Optical output into 9/125 fiber:	-12 dBm
Receiver sensitivity:	-31 dBm
Maximum input power:	-1 dBm

## SM/SC/13L/R Module

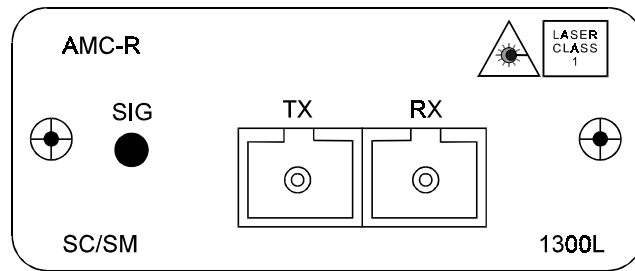

Figure 2-15 SM/SC/13L/R Module Front Panel

Wavelength:	1300 nm
Connector:	SC
Used with:	Single mode fiber
Protocols supported:	STS-3c; STM-1, STS-1, FDDI, TAXI and Fast Ethernet
Timing mode:	Retimed
Coding method:	4B/5B, NRZ
Optical output into 9/125 fiber:	-12 dBm
Receiver sensitivity:	-31 dBm
Maximum input power:	-1 dBm

## SM/ST/13LH/R Module

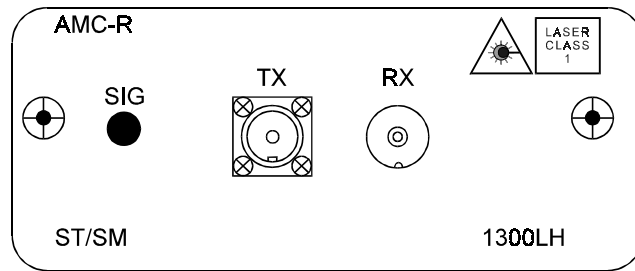
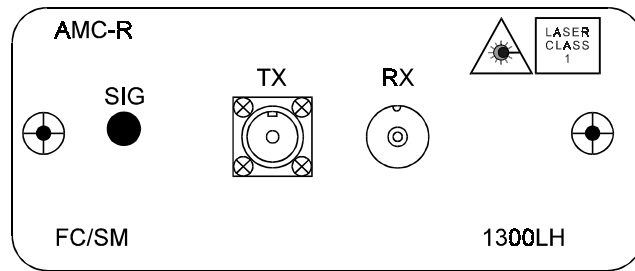

Figure 2-16 SM/ST/13LH/R Module Front Panel

Wavelength:	1300 nm
Connector:	ST
Used with:	Single mode fiber
Protocols supported:	STS-3c; STM-1, STS-1, FDDI, TAXI and Fast Ethernet
Timing mode:	Retimed
Coding method:	4B/5B, NRZ
Optical output into 9/125 fiber:	-2 dBm
Receiver sensitivity:	-34 dBm
Maximum input power:	-1 dBm

**SM/FC/13LH/R Module**

*Figure 2-17 SM/FC/13LH/R Module Front Panel*

Wavelength:	1300 nm
Connector:	FC
Used with:	Single mode fiber
Protocols supported:	STS-3c; STM-1, STS-1, FDDI, TAXI and Fast Ethernet
Timing mode:	Retimed
Coding method:	4B/5B, NRZ
Optical output into 9/125 fiber:	-2 dBm
Receiver sensitivity:	-34 dBm
Maximum input power:	-1 dBm



## SM/ST/15L/R Module

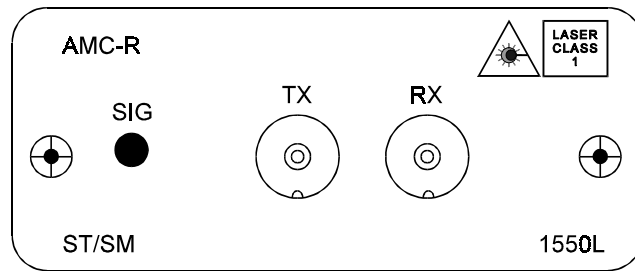

*Figure 2-18 SM/ST/15L/R Module Front Panel*

Wavelength:	1550 nm
Connector:	ST
Used with:	Single mode fiber
Protocols supported:	STS-3c, STM-1, STS-1, FDDI, TAXI and Fast Ethernet
Timing mode:	Retimed
Coding method:	4B/5B, NRZ
Optical output into 9/125 fiber:	-12 dBm
Receiver sensitivity:	-31 dBm
Maximum input power:	-1 dBm

## SM/ST/15LH/R Module

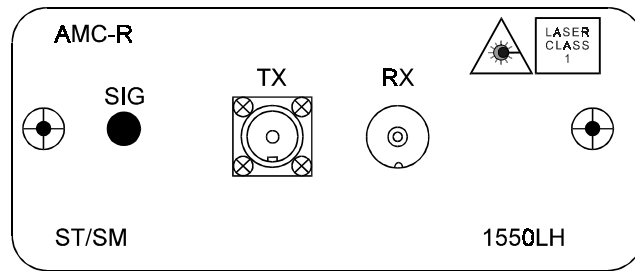

Figure 2-19 SM/ST/15LH/R Module Front Panel

Wavelength:	1550 nm
Connector:	ST
Used with:	Single mode fiber
Protocols supported:	STS-3c; STM-1, STS-1, FDDI, TAXI and Fast Ethernet
Timing mode:	Retimed
Coding method:	4B/5B, NRZ
Optical output into 9/125 fiber:	-2 dBm
Receiver sensitivity:	-34 dBm
Maximum input power:	-1 dBm

## SM/FC/15LH/R Module

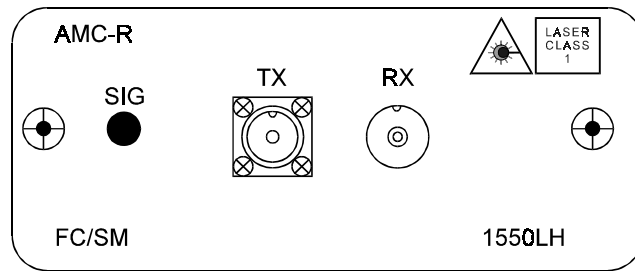

Figure 2-20 SM/FC/15LH/R Module Front Panel

Wavelength:	1550 nm
Connector:	FC
Used with:	Single mode fiber
Protocols supported:	STS-3c, STM-1, STS-1, FDDI, TAXI and Fast Ethernet
Timing mode:	Retimed
Coding method:	4B/5B, NRZ
Optical output into 9/125 fiber:	-2 dBm
Receiver sensitivity:	-34 dBm
Maximum input power:	-1 dBm

## MM/ST/85/T Module

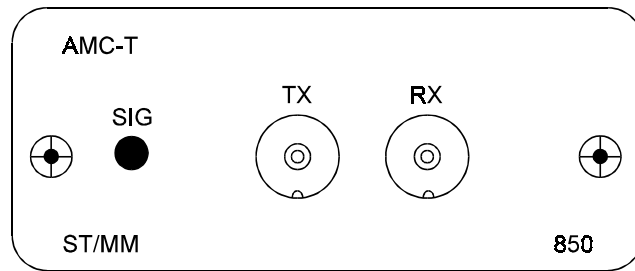

Figure 2-21 MM/ST/85/T Module Front Panel

Wavelength:	850 nm
Connector:	ST
Used with:	Multimode fiber
Protocols supported:	Token Ring, Ethernet only
Timing mode:	Transparent
Coding method:	4B/5B, NRZ, Manchester
Optical output into 62.5/125 fiber:	-18 dBm
Receiver sensitivity:	-30 dBm
Maximum Input Power	-12 dBm

## SF1/ST/R Module

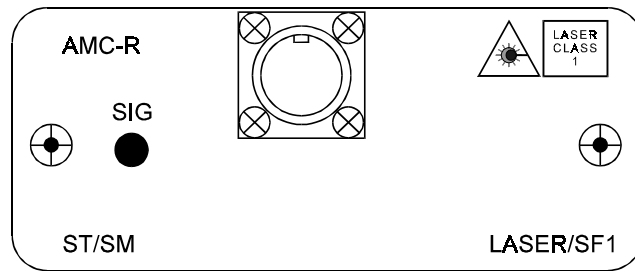

Figure 2-22 SF1/ST/R Module Front Panel

Wavelength:	Transmit: 1300 nm; Receive: 1550 nm
Connector:	ST
Used with:	Single mode fiber
Protocols supported:	STS-3c, STM-1, STS-1, FDDI, TAXI and Fast Ethernet
Timing mode:	Retimed
Optical output into 9/125 fiber:	-12 dBm
Receiver sensitivity:	-29 dBm

## SF2/ST/R Module

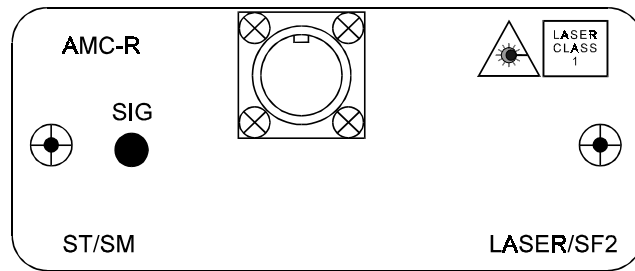
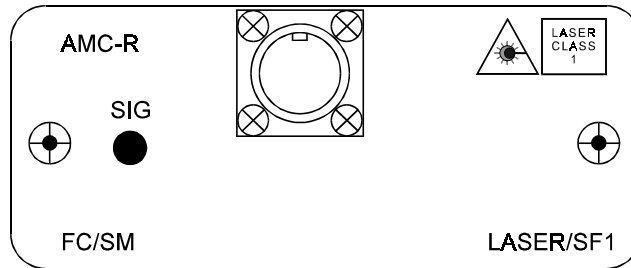

Figure 2-23 SF2/ST/R Module Front Panel

Wavelength:	Transmit: 1550 nm; Receive: 1300 nm
Connector:	ST
Used with:	Single mode fiber
Protocols supported:	STS-3c, STM-1, STS-1, FDDI, TAXI and Fast Ethernet
Timing mode:	Retimed
Optical output into 9/125 fiber:	-12 dBm
Receiver sensitivity:	-29 dBm

**SF1/FC/R Module**

*Figure 2-24 SF1/FC/R Module Front Panel*

Wavelength:	Transmit: 1300 nm; Receive: 1550 nm
Connector:	FC
Used with:	Single mode fiber
Protocols supported:	STS-3c, STM-1, STS-1, FDDI, TAXI and Fast Ethernet
Timing mode:	Retimed
Optical output into 9/125 fiber:	-12 dBm
Receiver sensitivity:	-29 dBm

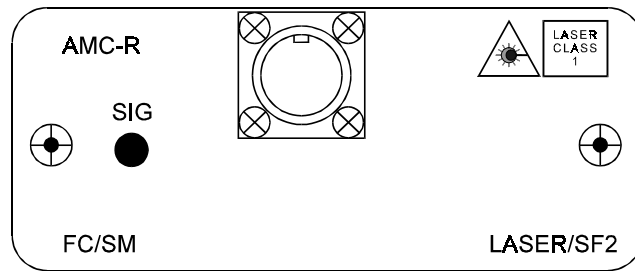
**SF2/FC/R Module**

*Figure 2-25 SF2/FC/R Module Front Panel*

Wavelength:	Transmit: 1550 nm; Receive: 1300 nm
Connector:	FC
Used with:	Single mode fiber
Protocols supported:	STS-3c, STM-1, STS-1, FDDI, TAXI and Fast Ethernet
Timing mode:	Retimed
Optical output into 9/125 fiber:	-12 dBm
Receiver sensitivity:	-29 dBm



## CX/BNC/155/R Module

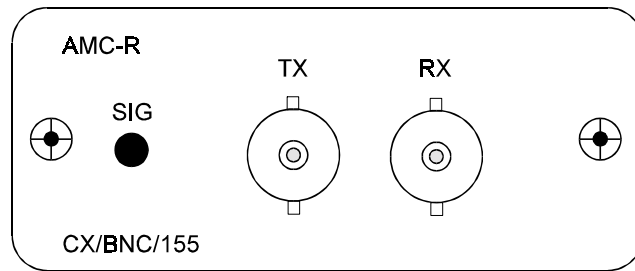

Figure 2-26 CX/BNC/155/R Module Front Panel

Connector:	BNC
Used with:	Coax cable
Protocols supported:	STS-3c, STM-1
Timing mode:	Retimed
Range calculation:	12.7 dB at 78 MHz according to square root of frequency law
Impedance:	75 $\Omega$

## CX/DIN/155/R Module

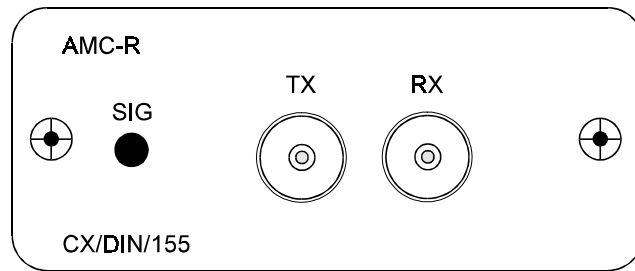

Figure 2-27 CX/DIN/155/R Module Front Panel

Connector:	1.6/5.6 Coax
Used with:	Coax cable
Protocols supported:	STS-3c, STM-1
Timing mode:	Retimed
Range calculation:	12.7 dB at 78 MHz according to square root of frequency law; 135 m is attainable when using RG-59 B/U cables (Cable length varies in accordance with cable type)
Impedance:	75 $\Omega$

### STP/155/R Module

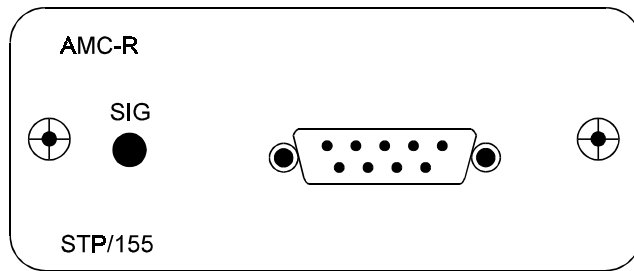

Figure 2-28 STP/155/R Module Front Panel

Connector:	DB-9
Used with:	STP type 1 cable
Protocols supported:	STS-3c
Timing mode:	Retimed
Coding method:	NRZ
Range:	100 m
Impedance:	150 Ω

Table 2-1 STP/155/R Pinout

Pinout	
Pin 1	Rx +
Pin 2	
Pin 3	
Pin 4	
Pin 5	Tx +
Pin 6	Rx -
Pin 7	
Pin 8	
Pin 9	Tx -

## STP/155/T Module

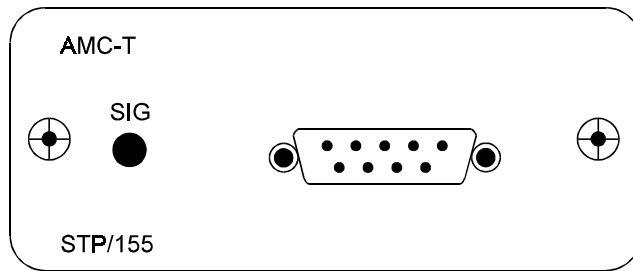

Figure 2-29 STP/155/T Module Front Panel

Connector:	DB-9
Used with:	STP type 1 cable
Protocols supported:	STS-3c
Timing mode:	Transparent
Coding method:	NRZ
Range:	50 m
Impedance:	150 $\Omega$

Table 2-2 STP/155/T Pinout

Pinout	
Pin 1	Rx +
Pin 2	
Pin 3	
Pin 4	
Pin 5	Tx +
Pin 6	Rx -
Pin 7	
Pin 8	
Pin 9	Tx -

### UTP/155/R Module

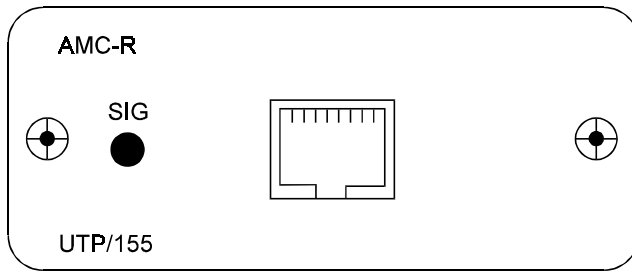

Figure 2-30 UTP/155/R Module Front Panel

Connector:	Shielded RJ-45
Used with:	UTP Cat 5
Protocols supported:	STS-3c
Timing mode:	Retimed
Coding method:	NRZ
Range:	100 m
Impedance:	100 Ω

Table 2-3 UTP/155/R Pinout

Pinout	
Pin 1	Tx+
Pin 2	Tx-
Pin 3	
Pin 4	
Pin 5	
Pin 6	
Pin 7	Rx+
Pin 8	Rx-

## UTP/155/T Module

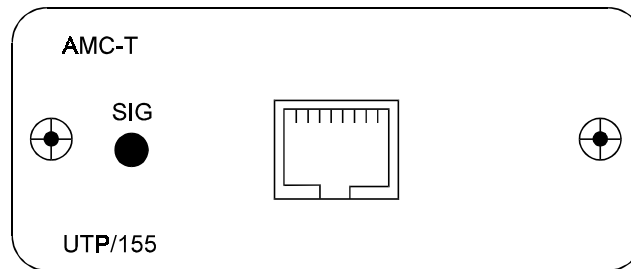

Figure 2-31 UTP/155/T Module Front Panel

Connector:	Shielded RJ-45
Used with:	UTP Cat 5
Protocols supported:	STS-3c
Timing mode:	Transparent
Coding method:	NRZ
Range:	50 m
Impedance:	100 $\Omega$

Table 2-4 UTP/155/T Pinout

Pinout	
Pin 1	Tx+
Pin 2	Tx-
Pin 3	
Pin 4	
Pin 5	
Pin 6	
Pin 7	Rx+
Pin 8	Rx-

### UTP/100/R Module

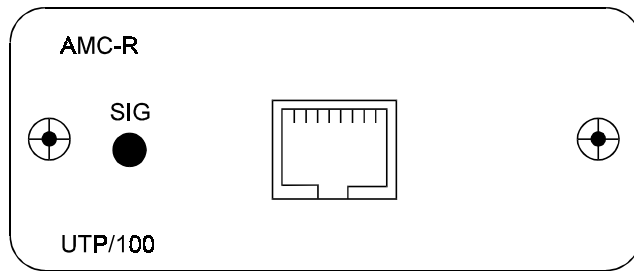

Figure 2-32 UTP/100/R Module Front Panel

Connector:	Shielded RJ-45
Used with:	UTP Cat 5
Protocols supported:	FDDI
Timing mode:	Retimed
Coding method:	NRZ
Range:	100 m
Impedance:	100 Ω

Table 2-5 UTP/100/R Pinout

Pinout	
Pin 1	Tx+
Pin 2	Tx-
Pin 3	
Pin 4	
Pin 5	
Pin 6	
Pin 7	Rx+
Pin 8	Rx-

## UTP/100/T Module

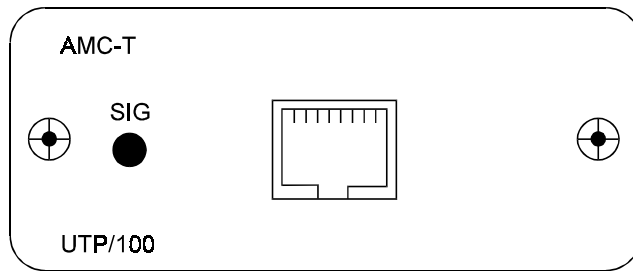

Figure 2-33 UTP/100/T Module Front Panel

Connector:	Shielded RJ-45
Used with:	UTP Cat 5
Protocols supported:	FDDI
Timing mode:	Transparent
Coding method:	NRZ
Range:	50 m
Impedance:	100 $\Omega$

Table 2-6 UTP/100/T Pinout

Pinout	
Pin 1	Tx+
Pin 2	Tx-
Pin 3	
Pin 4	
Pin 5	
Pin 6	
Pin 7	Rx+
Pin 8	Rx-



## 100BT/B Module

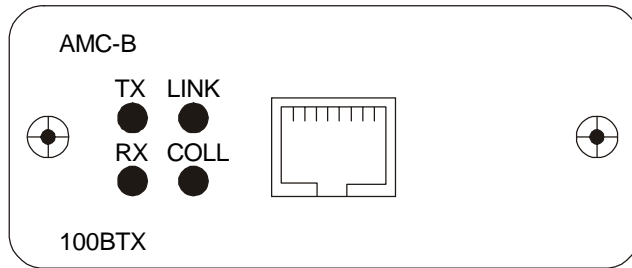

Figure 2-34 100BT/B Module Front Panel

Connector:	Shielded RJ-45
Used with:	UTP Cat 5
Protocols supported:	Fast Ethernet (100 Base TX): Half Duplex on UTP side and Full Duplex on second module side
Timing mode:	Retimed & Bridged
Coding method:	4B/5B, MLT-3
Range:	80 m
Impedance:	100 Ω
Special Features	Bridging, Filtering, Half Duplex to Full Duplex conversion

Table 2-7 100BT/B Module Pinout

Pinout	
Pin 1	Tx+
Pin 2	Tx-
Pin 3	Rx+
Pin 4	
Pin 5	
Pin 6	Rx-
Pin 7	
Pin 8	

## 100BT/R Module

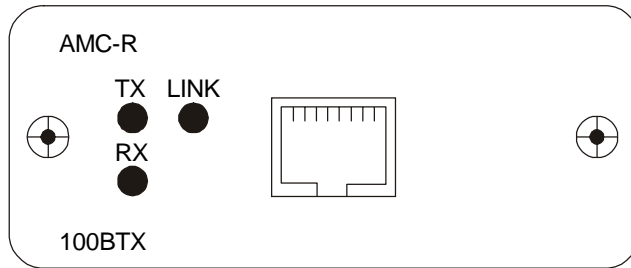

Figure 2-35 100BT/R Module Front Panel

Connector:	Shielded RJ-45
Used with:	UTP Cat 5
Protocols supported:	Fast Ethernet (100 Base TX): Half or Full Duplex (HDX to HDX or FDX to FDX)
Timing mode:	Retimed
Coding method:	4B/5B, MLT-3
Range:	80 m
Impedance:	100 $\Omega$

Table 2-8 100BT/R Module Pinout

Pinout	
Pin 1	Tx+
Pin 2	Tx-
Pin 3	Rx+
Pin 4	
Pin 5	
Pin 6	Rx-
Pin 7	
Pin 8	

### 10BT/B Module

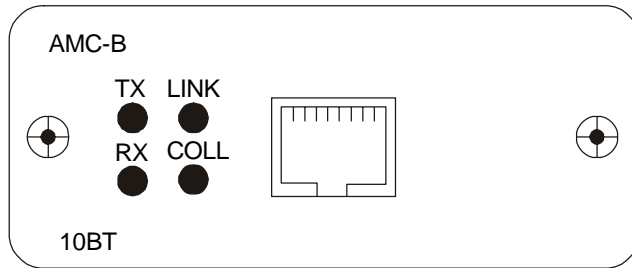

Figure 2-36 10BT/B Module Front Panel

Connector:	Shielded RJ-45
Used with:	UTP Cat 5
Protocols supported:	Ethernet (10Base-T): Half or Full Duplex
Timing mode:	Retimed
Range:	100 m
Impedance:	100 Ω

Table 2-9 10BT/B Module Pinout

Pinout	
Pin 1	Tx+
Pin 2	Tx-
Pin 3	Rx+
Pin 4	
Pin 5	
Pin 6	Rx-
Pin 7	
Pin 8	

**Note** 10BT/B modules (Half Duplex or Full Duplex) operate with Transparent modules.

# Chapter 3

---

## Operation

---

### 3.1 Controls and Indicators

All controls and indicators are located on the front panel of AMC-101.

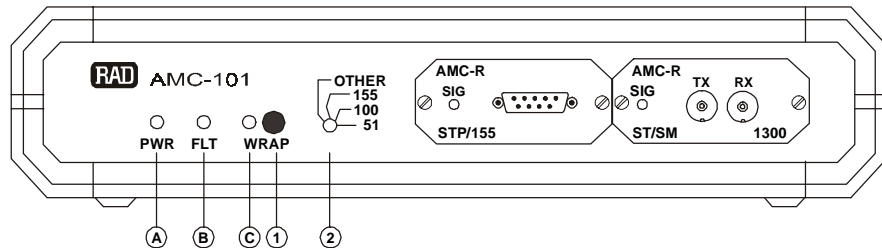

Figure 3-1 AMC-101 Front Panel

Table 3-1 AMC-101 Front Panel Indicators

Indicators	Description
POWER:	ON when unit is powered (GREEN)
FAULT:	BLINKS when card configuration is wrong (RED)
WRAP:	ON when the two interfaces are wrapped (GREEN)

Table 3-2 AMC-101 Front Panel Controls

Controls	Description
WRAP:	Activates loopback at the two interfaces
RATE:	For data rate selection (51, 100, 155 Mbps) or transparent mode (other)

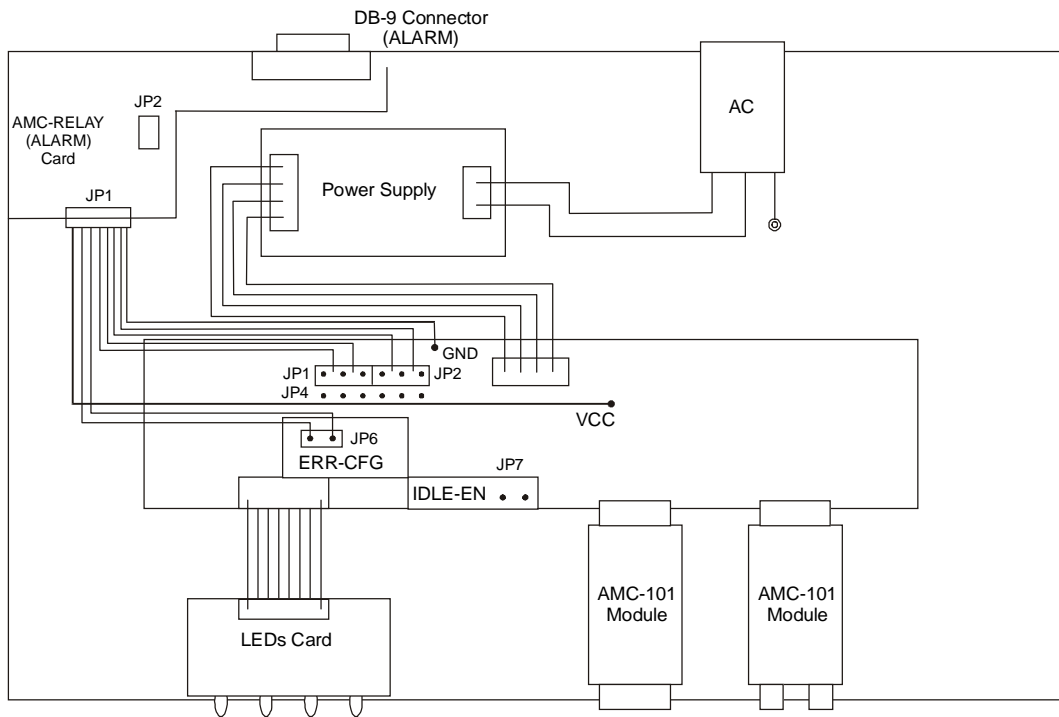

Figure 3-2 Jumper Locations and Functions

Table 3-3 Functions and Settings

Jumper ID	Function	Conditional Setting
JP2	ERR-CFG	Mounted (Factory Default)
JP7	Idle-Enable	If mounted, idle will be transmitted when no signal is received from the other side. Not mounted (Factory Default)

### 3.2 Cable Connections

**Grounding**

DC adapter Connection.

**Note**

*In order to protect the AMC-1 from electrostatic discharge (ESD), use a DC adapter where the (-) DC pole is connected to the protective earth.*

### 3.3 Dry Contact Circuit and Connector for Alarms

A dry circuit with a 9-pin D-type connector on the rear panel, has been added to the unit to signal minor and major alarms. The dry contact circuit is used to signal the following alarms:

Alarm type	Description
RED ALARM	Power Failure (DC voltage on board)
YELLOW ALARM	Signal Detect Failure (to any of the unit modules)
CONFIG ALARM	Improper Configuration (incompatible modules and/or data rates selected)

Three pins are dedicated for each alarm: Common (COM), OK and FAIL. The COM pin is the input for each alarm. The user can drive the COM pin with any signal (0 to 5v). If the signal is received OK, the COM pin is connected to its corresponding OK pin; If there is a failure, the COM pin is connected to its corresponding FAIL pin. See *Table 3-4* and *Figure 3-3* for the connector pin assignments.

*Table 3-4 Connector Pin Assignment*

Alarm Type	COM	OK	FAIL
RED	9	4	5
YELLOW	3	8	7
CONFIG	6	2	1

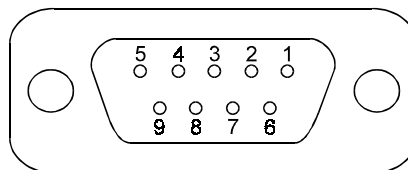

*Figure 3-3 Connector Pin Assignment*

**Example:**

For the RED ALARM the common input (COM) pin is 9. If there is no power failure, it connects to pin 4 (OK). If there is a failure, pin 9 connects to pin 5 (FAIL).

---

---

**3.4 Turning on the AMC-101**

Connect the AC cable of AMC-101 to the mains outlet. The POWER indicator on the front panel should light up.

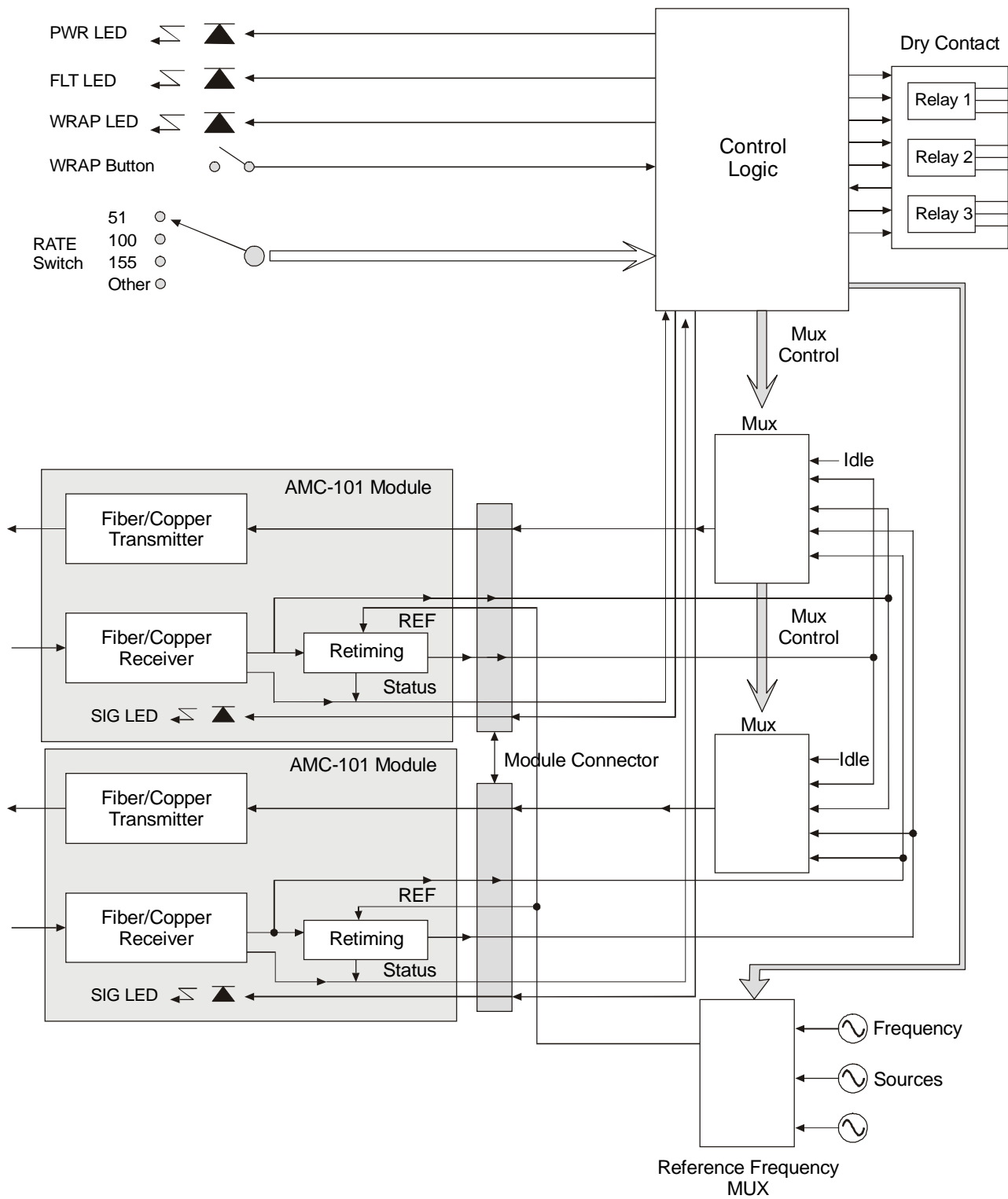

Figure 3-4 AMC-101 Block Diagram



---

---

### 3.5 Normal Operation

Once powered on, the POWER indicator should light up and the FLT should be turned off. If the FLT indicator blinks, a configuration error exists: the combination of the card types and the selected data rate is illegal.

Each AMC-101 module contains a SIG indicator. If the SIG indicator is turned off; no signal is received by the module. If the SIG is turned on; a signal is received by the module, and if the re-timing option is in use, the PLL is synchronized to the receive signal. If the SIG blinks, a signal is received by the module but the PLL is out of sync.

A special circuitry can be configured to transmit idle signal in case of not receiving any signal from the other side. This option is enabled by the idle jumper (JP-6) and can be used for power measurements in case of absence of "real" data.

The WRAP function can be locally activated at any time and causes the signal received by the module to be transmitted by the same module. If the module features retiming, the looped back signal is retimed and re-clocked.

---

---

### 3.6 Turning off the AMC-101

Disconnect the AMC-101 AC cable from the mains outlet.

---

---

### 3.7 Troubleshooting Procedures

#### The POWER LED does not light up

Check the power cord connection on the back of the unit and at the mains outlet.

- Verify power availability at the mains outlet.

#### Data transmission difficulties

Ensure that the plugged-in modules are compatible with the protocol used (media, data rate).

Ensure that the FLT LED is off. (If the LED blinks, a configuration error exists: the combination of the module types and the selected data rate is illegal).

Verify that the SIG LED is on and fixed. If the LED is off, no signal is being received by the module. If the LED is blinking, the module PLL is out of sync.

Use the WRAP option to localize the problematic segment.

## Free Manuals Download Website

<http://myh66.com>

<http://usermanuals.us>

<http://www.somanuals.com>

<http://www.4manuals.cc>

<http://www.manual-lib.com>

<http://www.404manual.com>

<http://www.luxmanual.com>

<http://aubethermostatmanual.com>

Golf course search by state

<http://golfingnear.com>

Email search by domain

<http://emailbydomain.com>

Auto manuals search

<http://auto.somanuals.com>

TV manuals search

<http://tv.somanuals.com>