

# MINUTE MAN<sup>®</sup>

## X R T Series

Uninterruptible Power Supply

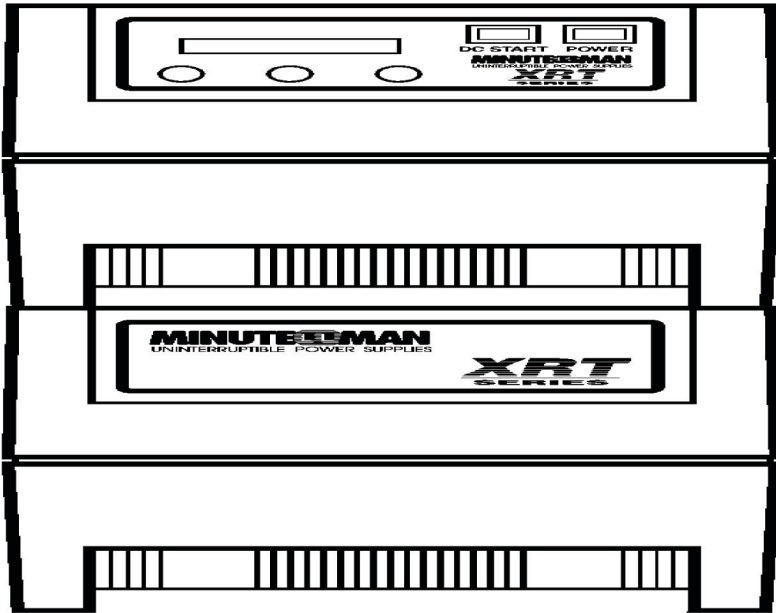

User's Manual



1-866-207-6631 | [www.rackmountsolutions.net](http://www.rackmountsolutions.net)  
sales@rackmountsolutions.net



# XRT Series User's Manual

## Table of Contents

<b>1. INTRODUCTION</b>	<b>2</b>
RECEIVING INSPECTION	3
SAFETY INSTRUCTIONS	4
<b>2. SYSTEM DESCRIPTION</b>	<b>6</b>
FEATURES	7
<b>3. INSTALLATION</b>	<b>9</b>
CAUTIONS	9
PROTECTION STRATEGIES	9
INSTALLATION PLACEMENT	9
INSTALLATION, STEP BY STEP	11
<b>4. OPERATION</b>	<b>15</b>
FRONT PANELS	15
ALARMS AND WARNINGS	22
WARNING EVENTS	23
OPTIONS	23
<b>5. SYSTEM BATTERIES</b>	<b>24</b>
STORAGE INSTRUCTIONS	24
BATTERY REPLACEMENT	25
<b>6. TROUBLESHOOTING</b>	<b>26</b>
TROUBLESHOOTING CHART	26
INITIAL ERROR MESSAGES	27
OPERATING FAULTS	29
SELF TEST	30
<b>7. OBTAINING SERVICE</b>	<b>31</b>
<b>8. GENERAL PRODUCT SPECIFICATIONS</b>	<b>33</b>
REMOTE COMMUNICATIONS	35
REMOTE DIRECT COMMUNICATIONS	35
BATTERY PACK AND RUN TIME SPEC' S	37
<b>9. LIMITED PRODUCT WARRANTY</b>	<b>39</b>

# 1. INTRODUCTION

Thank you for purchasing the Minuteman XRT series of Uninterruptible Power Supplies. It has been designed and manufactured to provide many years of trouble free service.

## **IMPORTANT!**

Please read this manual before installing your UPS as it provides the information to correctly set up your system for the maximum safety and performance. Included is information on how the UPS functions to protect your equipment from power line induced spikes, RFI and EMI, blackouts, brownouts, sags and over-voltage conditions.

Included is information on customer support and factory service if it is required. If you experience a problem with the UPS please refer to the Troubleshooting guide in this manual to correct the problem or collect enough information so that the Minuteman technical support department can rapidly assist you.

## **Para Systems Life Support Policy**

As a general policy, Para Systems Inc. does not recommend the use of any of its products in life support applications where failure or malfunction of the Para Systems product can be reasonably expected to cause failure of the life support device or to significantly affect its safety or effectiveness. Para Systems does not recommend the use of any of its products in direct patient care. Para Systems will not knowingly sell its products for use in such applications unless it receives in writing assurances satisfactory to Para Systems that (a) the risks of injury or damage have been minimized, (b) the customer assumes all such risks, and (c) the liability of Para Systems Inc. is adequately protected under the circumstances.

Examples of devices considered to be life support devices are neonatal oxygen analyzers, nerve stimulators (whether used for anesthesia, pain relief, or other purposes), auto transfusion devices, blood pumps, defibrillators, arrhythmia detectors and alarms, pacemakers, hemodialysis systems, peritoneal dialysis systems, neonatal ventilator incubators, ventilators for both adults and infants, anesthesia ventilators, and infusion pumps as well as any other devices designated as "critical" by the United States FDA.

Hospital grade wiring devices and leakage current may be ordered as options on many Para Systems UPS systems. Para Systems does not claim that units with this modification are certified or listed as Hospital Grade by Para Systems or any other

organization. Therefore, these units do not meet the requirements for use in direct patient care.

## RECEIVING INSPECTION

After removing your Minuteman XRT UPS from its carton, it should be inspected for damage that may have occurred in shipping. Immediately notify the carrier and place of purchase if any damage is found. Warranty claims for damage caused by the carrier will not be honored.

### **PLEASE SAVE THE PACKING MATERIALS!**

The packing materials that your UPS was shipped in are carefully designed to minimize any shipping damage. In the unlikely case that the UPS needs to be returned to Minuteman, please use the original packing material. Since Minuteman is not responsible for shipping damage incurred when the system is returned, the original packing material is inexpensive insurance.

**Note:** This equipment has been tested and found to comply with the limits for a Class A digital device, pursuant to part 15 of the FCC rules. These limits are designed to provide reasonable protection against harmful interference when the equipment is operated in a commercial environment. This equipment generates, uses, and can radiate radio frequency energy and, if not installed and used in accordance with the instruction manual, may cause harmful interference to radio communications. Operation of this equipment in a residential area is likely to cause harmful interference, in which case the user will be required to correct the interference at his own expense.

This digital apparatus does not exceed the Class A limits for radio noise emissions from digital apparatus set out in the Radio Interference Regulations of the Canadian Department of Communications.

Le présent appareil numérique n'émet pas de bruits radioélectriques dépassant les limites applicables aux appareils numériques de la Class A prescrites dans le Règlement sur le brouillage radioélectrique édicté par le ministère des Communications du Canada.

**Shielded communications cables  
must be used with this equipment**

## RADIO FREQUENCY INTERFERENCE

**Warning:** Changes or modifications to this unit not expressly approved by the party responsible for compliance could void the users authority to operate this equipment.

# IMPORTANT SAFETY INSTRUCTIONS

## **SAVE THESE INSTRUCTIONS** **THIS MANUAL CONTAINS IMPORTANT** **SAFETY INSTRUCTIONS;**

Read this manual carefully before operating the UPS. All instructions and warnings should be followed during installation, operation and maintenance of the UPS.

**CAUTION:** RISK OF ELECTRICAL SHOCK. HAZARDOUS LIVE PARTS INSIDE THIS POWER SUPPLY ARE ENERGIZED FROM THE BATTERY SUPPLY EVEN WHEN THE INPUT AC POWER IS DISCONNECTED.

**CAUTION:** A BATTERY CAN PRESENT A RISK OF ELECTRICAL SHOCK, OR BURN FROM HIGH SHORT-CIRCUIT CURRENT. OBSERVE PROPER PRECAUTIONS.

**CAUTION:** WHEN REPLACING BATTERIES USE THE SAME NUMBER AND TYPE OF SEALED LEAD-ACID BATTERIES.

**CAUTION:** PROPER DISPOSAL OF BATTERIES IS REQUIRED. REFER TO YOUR LOCAL CODES FOR DISPOSAL REQUIREMENTS.

**CAUTION:** AVOID INSTALLING THE UNINTERRUPTIBLE POWER SUPPLY (UPS) IN LOCATIONS WHERE THERE IS WATER OR EXCESSIVE HUMIDITY.

**CAUTION:** CONNECT THE UNINTERRUPTIBLE POWER SUPPLY TO A TWO POLE, THREE WIRE GROUNDING MAINS RECEPTACLE. THE RECEPTACLE MUST BE CONNECTED TO APPROPRIATE BRANCH PROTECTION (FUSE OR CIRCUIT BREAKER). CONNECTION TO ANY OTHER TYPE OF RECEPTACLE MAY RESULT IN A SHOCK HAZARD AND MAY VIOLATE LOCAL ELECTRICAL CODES.

**CAUTION:** DO NOT ALLOW WATER OR ANY FOREIGN OBJECT TO GET INSIDE THE UNINTERRUPTIBLE POWER SUPPLY. DO NOT PUT OBJECTS CONTAINING LIQUIDS ON OR NEAR THE UNIT.

# INSTRUCTIONS IMPORTANTES CONCERNANT LA SÉCURITÉ

## CONSERVER CES INSTRUCTIONS. CETTE NOTICE CONTIENT DES INSTRUCTIONS IMPORTANTES CONCERNANT LA SÉCURITÉ.

**ATTENTION:** RISQUE DE CHOC ÉLECTRONIQUE. CE BLOC D' ALIMENTATION COMPORTE DES PIÈCES SOUS TENSION DANGEREUSE ALIMENTÉES PAR LES PILES MEME LORSQU'IL EST DÉBRANCHÉ DU SECTEUR.

**ATTENTION:** UNE BATTERIE PEUT PRÉSENTER UN RISQUE DE CHOC ÉLECTRIQUE, OU DE BRULURE PAR TRANSFERT D'ENERGIE. SUIVRE LES PRÉCAUTIONS QUI S'IMPOSENT.

**ATTENTION:** POUR LE REMPLACEMENT, UTILISER LE MEME NOMBRE DE BATTERIES DU MODÈLE LEAD-ACID SCELLÉES.

**ATTENTION:** L'EMINATION DES BATTERIES EST RÉGLEMENTÉE. CONSULTER LES CODES LOCAUX À CET EFFET.

**ATTENTION:** LA SOURCE D' ALIMENTATION PERMANENTE (UPS) DANS UNE PRISE DE COURANT À 3 DÉRIVATIONS (DEUX POLES ET LA TERRE). CETTE PRISE DOIT ÊTRE MUNIE D'UNE PROTECTION ADÉQUATE (FUSIBLE OU COUPE-CIRCUIT). LE BRANCHEMENT DANS TOUT AUTRE GENRE DE PRISE POURRÎT ENTRAÎNER UN RISQUE D'ÉLECTROCUTION ET PEUT CONSTITUER UNE INFRACTION À LA RÉGLEMENTATION LOCALE CONCERNANT LES INSTALLATIONS ÉLECTRIQUES.

**ATTENTION:** NE PAS INSTALLER LA SOURCE D' ALIMENTATION PERMANENTE (UPS) DANS UN ENDROIT OÙ IL Y A DE L'EAU OU UNE HUMIDITÉ EXCESSIVE.

**ATTENTION:** NE PAS LAISSER DE L'EAU OU TOUT OBJET PÉNÉTRER DANS LA SOURCE D' ALIMENTATION PERMANENTE (UPS). NE PAS PLACER DE RÉCIPIENTS CONTENANT UN LIQUIDE SUR CET APPAREIL, NI À PROXIMITÉ DE CELUI-CI.



## 2. SYSTEM DESCRIPTION

The XRT series of Uninterruptible power supplies are based on an advanced true sine wave power system that filters and protects the electronic equipment from all types of power line problems. The various models provide from 600 VA to 2000 VA of power for voltage ranges of 120 VAC, 208 VAC and 240 VAC single phase 60 Hz. units, and 220 VAC through 240 VAC 50 Hz. units. At all power levels and voltage ranges the load is protected against AC line spikes, surges, dropouts, brownouts and blackouts. All 60 Hertz models include electrical isolation from the power line to the AC load. During operation, all of the critical parameters are continuously monitored. The parameters may be monitored at the UPS with an LED display on the XRT600, or with a sophisticated LCD display that contains 32 characters on the XRT1000 and larger units. In all models the communications port can be used with the Minuteman Sentry or PowerMon software to report all of the critical parameters as well as controlling the UPS' s functions via remote control. Built in is the provision for a remote master Output Power OFF switch so that a user-supplied power down switch or relay can immediately shut off the output power.

The XRT series of UPS' s are "Line-Interactive" . That is, during normal operation from the AC line, the line AC is passed through an isolation transformer\* and filtering system that provides the maximum efficiency, safety and reliability. During normal AC operation, the incoming line voltage is continuously monitored and automatic correction is made for under-voltage or over-voltage conditions. This provides AC line correction for a range of 75% to 116% of the nominal line voltage. When these limits are exceeded, or if the line frequency varies more than plus or minus 3 Hertz, the unit automatically switches to battery power until normal AC is restored. In normal operation the battery is continuously charged so that full battery power is always available.

\*Isolation transformer is on the 60 Hz. units only.

## FEATURES

### **Extended Battery Run Time**

All models of the XRT series may add multiple optional external XRTBP battery packs to extend the time that the units can provide power. UPS de-rating is not required for the additional battery packs. The XRT600 model contains an internal battery, whereas the higher power models require at least one XRTBP battery pack.

### **RFI/EMI Suppression**

The design features, not only the standard input line filtering, but contains a specially manufactured transformer that shields the output from line and inverter spikes resulting from capacitive coupling between windings. This double protection insures that interference and spikes cannot get to your equipment, and conversely your equipment cannot transmit spikes to other equipment on the power line.

### **No Power Factor De-rating**

The XRT series of UPS' s automatically support power factors in the range of 0.6 to 1.0. This means that no de-rating is required for high power factors since the unit is capable of supplying full rated power (instantaneous watts) in either the ON-LINE or On-Battery conditions.

### **Enhanced Battery Management**

To maintain the service life of the battery, the XRT provides various features. During normal on-line functions the XRT continuously monitors the battery voltage and keeps the battery at full charge via an intelligent battery charger built into the unit. The battery' s condition is monitored at all times, and if a low battery condition is detected, the condition is reported to the front panel and to the serial communications port. If a low battery condition is detected, the unit will continue to function on the AC line. While the unit is on-line, the external battery pack(s) may be replaced without disruption to the output power. In the XRT1000, XRT1500 and XRT2000 units, the battery charge condition is reported by the battery voltage on the LCD display screen, whereas in the XRT600 unit the battery charge condition is reported by LED' s on the front panel.

### **Remote Communication and Control**

Built into the XRT series is a Minuteman standard RS-232 communications port. With the Minuteman Power Management software, 2-way communications can be maintained with a remote computer. All pertinent data about the UPS can be transmitted to the computer, and

commands from the computer can control the UPS. The interface also allows a single switch to control the output power from the UPS so that a user-supplied Output Power Off switch or relay can immediately remove power from the load, or restore power once the problem has been corrected. See **Remote Communications** chapter for details of the communications port.

### **Built in Self Test**

To insure the functionality of the UPS, there are four built-in self tests. The first is when the unit is switched on, a self test is run to insure the operation of the backup mode, the condition of the battery and the inverter circuit. This test takes about 10 seconds. Pressing the Test button, or selecting the Quick Test command from the LCD menu will run the built-in self test, verifying the operation of the UPS. The third test mode runs a self test every 14 days to insure the UPS is always ready to respond to a power problem. The fourth test is the Test to Low Battery Warning and verifies the condition of the battery system by switching to inverter power until the battery reaches the Low Battery Warning condition and then switching back to the ON-LINE mode. During the "Test to Low Battery", you may monitor all of the status values and terminate the test at any time.

The XRT1000 through XRT2000 units have a 32 character LCD display, three push buttons, and the Power On and DC Start switches.

The Power and DC Start switch operate the same as the XRT600. The LCD display will step you through all of the functions of the UPS. The top line of the display indicates the parameter and function, and the bottom line displays the function of the three buttons below the display.

### 3. INSTALLATION

**CAUTION:** Do not connect a laser printer to the UPS along with other computer equipment unless the UPS is rated at 2000 VA or higher. A laser printer periodically draws significantly more power than when idle, and may overload the UPS. Verify that the UPS can support the loads when the printer is in full operation (printing).

#### PROTECTION STRATEGIES

Minuteman UPS' s provide high quality protection from AC input power line disturbances to your equipment. However, there are other potential entry points for damaging surges in information systems. These include serial ports (RS232, RS422, RS485, etc.), parallel ports (especially printers not connected to the UPS), telephone lines and network connections. These other entries must be considered in developing a comprehensive system protection strategy. Contact your dealer or Minuteman for information on a complete set of related products designed to accomplish total system protection. There are some guidelines listed below that will help in your installation, whether or not secondary protection is available.

Verify that all electrical outlets are properly grounded.

Do not connect the UPS and protected equipment to the same electrical service branch that heavy motor loads like air conditioners, copiers, refrigerators, and heavy electrical machinery are on. Plug all power protection and protected equipment into the same branch where possible.

Follow the next steps to install your UPS.

#### INSTALLATION PLACEMENT

Select the location of the UPS and optional battery pack(s) with care and use the following precautions:

Select a location that provides unrestricted air flow. It is important to leave at least 2 inches of space between any object and the sides of the UPS.

**Do not place anything on the top of the UPS.**  
**Avoid locations near heating devices.**  
**Avoid locations near water or excessive humidity.**  
**Do not expose the UPS to direct sunlight.**  
**Route power cords where they cannot be walked on or damaged, or surrounded by other power cords or communication cables.**  
**Use common sense about placing the UPS where it cannot be accidentally bumped or turned over.**

The battery packs and UPS unit must be placed on a level, smooth surface and cannot be stacked more than 4 units high. The UPS unit must be the topmost unit. A multiple battery pack suggested layout is shown below :

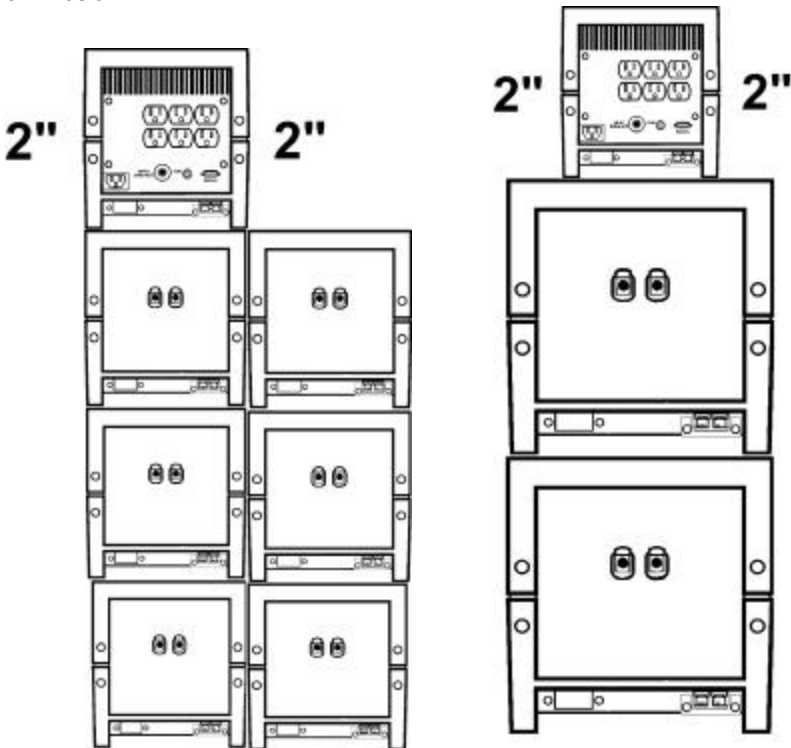

**Remember to leave at least 2 inches of clearance around the UPS unit for air flow.**

# INSTALLATION, STEP BY STEP

1. Insure UPS Power switch is OFF. Place the optional XRTBP battery pack(s), if used, and XRT UPS in its final location.
2. When installing the XRT1000 and above UPS' s or the XRT600 with optional battery pack(s):
  - a) Remove the self stick protective strip from the rear of the XRT600 (not required on XRT1000 , 1500, and 2000), and from the optional battery pack cable.
  - b) Loosen the retainer screw s on the rear of the UPS and drop the retainer bracket down.
  - c) Plug the battery pack cable connector into the XRT remote battery pack connector insuring connections mate RED to RED and BLACK to BLACK. Push the retaining bracket "up" to secure the battery connector in place and re-tighten the screw s.
  - d) Verify the bracket will not allow removal of the connector. Each battery pack is "daisy chained" in a similar fashion with the cable from the last battery pack connected to the previous pack. Remove the protective strips only from the battery connectors that are used.

**NOTE: When the protective strip is removed from the XRT UPS or the XRTBP cable connector, battery system voltage (48 VDC) is present at these connector contacts. Please keep the connector contacts covered with the protective strip when not mated with another connector.**

## Battery Pack Connection Diagram

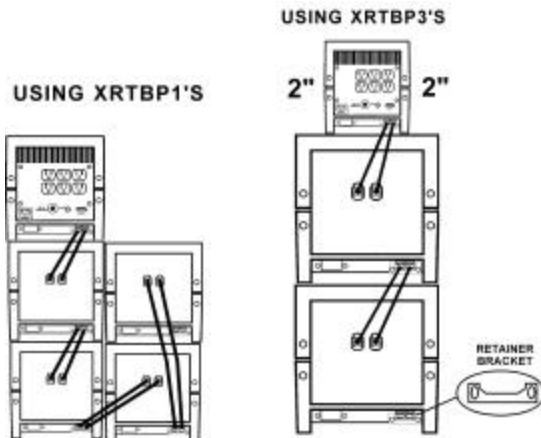

3. If you have additional Transient Voltage Surge Suppression (TVSS) devices in your system, they may be connected to the Earth Ground lug at the rear of the UPS. This provides a single point connection to minimize the potential of surges to disrupt the system. This lug is connected to the SAFETY GROUND lead in the AC input power cable.
4. Plug in the UPS to the utility power outlet.

### **XRT600, XRT1000, XRT1500 and XRT2000 Back panels**

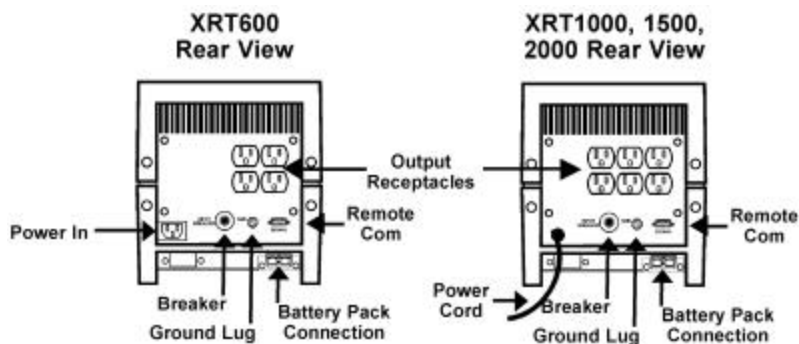

**NOTE: Due to various input and output options available, your unit may not be pictured exactly.**

The XRT600, XRT600/2, XRT1000, XRT1000/2 and XRT2000/2 are fitted with an IEC 320 input power connector. The remaining units have a pre-installed power cord to match their input power requirements and voltages. The IEC 320 connector is the familiar computer input power connector. XRT600 and XRT1000 units sold in the United States come with an input power cable with a standard 5-15 male plug on one end and an IEC 320 female plug on the other. Plug the IEC 320 connector into the UPS and the male plug into a standard wall socket. Power cords for all international models must be ordered separately if required.

5. If used, plug your remote communications line, into the DB-9 communications port connector. Your UPS will function correctly without using the port.

6. Turn the Power switch to the "on" position. With commercial power present and in the correct voltage and frequency range, the UPS will

automatically run a self test and at the successful completion, provide power to the output receptacles and indicate “normal AC”. Certain faults will prevent the UPS from supplying power to your equipment and will cause an error status to be displayed and an audible alarm to sound. If this occurs see the **TROUBLESHOOTING** section. To insure the batteries are completely charged, it is a good idea to leave the UPS on for 8 hours before using it to run your system. We understand that in most cases you may not have the luxury of waiting for the batteries to become fully charged, therefore you may install your equipment and begin using the UPS immediately. If a power failure occurs before the batteries are fully charged, the UPS may not supply power for the length of time you would normally expect in battery backup mode.

7. Plug all equipment to be protected into the UPS output receptacles.

**Insure that you do not exceed the maximum output power capability of the XRT UPS (refer to UPS back panel or electrical specifications in this manual).**

**Turn on your protected equipment one unit at a time and verify that the “100% Load” condition is not exceeded. Depending on the XRT model, the Load condition will be displayed on the front panel as follows:**

- a) The XRT600 will provide an indication of the UPS status on the LED front panel.

#### **XRT600 Front Panel Showing Load LED's**

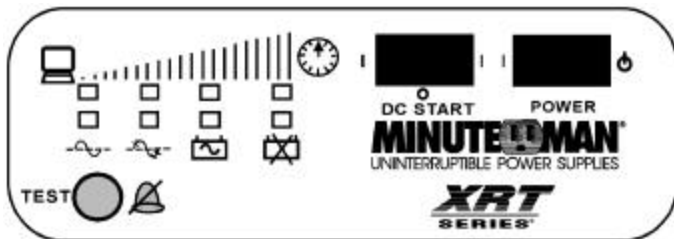

- b) The XRT1000 and above will display the UPS status on the LCD screen.



## Front Panel Load Menu on LCD Screen

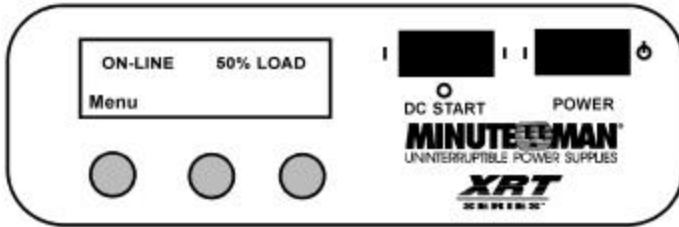

If an alarm condition exists, the condition will be reported on the front panel. If no AC Power is present and the battery is charged, pressing the DC START switch for approximately 5 seconds will bring up the UPS in the inverter mode and provide power to the protected equipment from the battery.

## 4. OPERATION

### FRONT PANELS

The operation of the UPS depends on which front panel is used. The following section explains the operation for the LED and the LCD front panels.

#### LED Front Panel

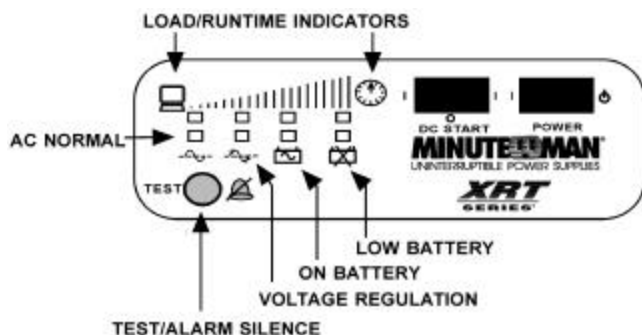

#### The top four LED's (Green) provide 3 functions.

- During normal AC operation: The top LED' s indicate a measure of load.
- During battery mode: The top LED' s indicate the battery charge condition which indicates approximate battery power remaining.
- During a fault condition: The top LED' s display an error code.

#### The second (bottom) row of LED's provide status information.

- AC normal LED: Glows green when normal AC is available to the unit.
- Regulator LED: Glows yellow when AC is present but outside normal range.
- On battery LED: Glows red when the unit is supplying power from the batteries (Inverter on).
- Low battery LED: Glows red when the batteries are weak and need charging or replacement.
- All LED' s off: This indicates the unit is turned off or an error condition has occurred. If an error has occurred, the internal alarm will sound and an error code will be displayed on the upper four LED' s. Refer to the **TROUBLESHOOTING** section for a description of the error code and the appropriate action to take.

## Switches

The Power switch turns the unit on and off. To start the UPS when AC power is not available, press and hold the DC Start button for about 5 seconds.

## The Test/Alarm Silence Button

The Test/Alarm Silence button allows you to run the quick self test when the UPS is in the normal mode. If an error was detected and you wish to reset the error display, press the Test/Alarm Silence button.

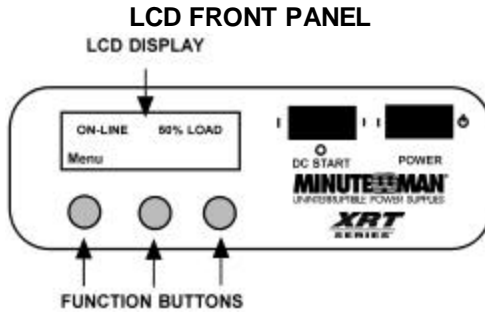

The XRT1000 through XRT2000 units have a 32 character LCD display, three push buttons, and the Power On and DC Start switches. (Both 120 and 220 VAC versions)

The Power On and DC Start switch operate the same as the XRT600.

The LCD display will step you through all of the functions of the UPS. The top line of the display indicates the parameter and function, and the bottom line displays the function of the three buttons below the display.

## Startup

When the unit is first turned on, the self test is executed and the message "Startup Diagnostics" is displayed. After successful completion of the self test, the message "MINUTEMAN Model XRTxxx" will be displayed for 5 seconds. The "On-Line xxx% Load" menu then appears. If the self test was not successful, or if an error event occurred the last time the UPS was powered on, then the message "Error Detected" will be shown on the top line of the display and the actual error message is shown on the second line (see the **Initial Error Message** list in the **TROUBLESHOOTING** section). Pressing any button will clear the message and allow the unit to power up and show one of two messages.

If the unit is being powered from the AC line, the percentage of actual load power available will be shown by the "ON-LINE xxx% Load" message. Otherwise, if the unit is being powered from the battery, "BACKUP xx.xV BAT" message is displayed. In either case, you may press the button under the "MENU" selection to step to the **STATUS** menu.

**Menu Flow**

Note: The "road-map" through the menu system is shown below. In each individual menu, pressing the "menu" button will take you to the next set of menus.

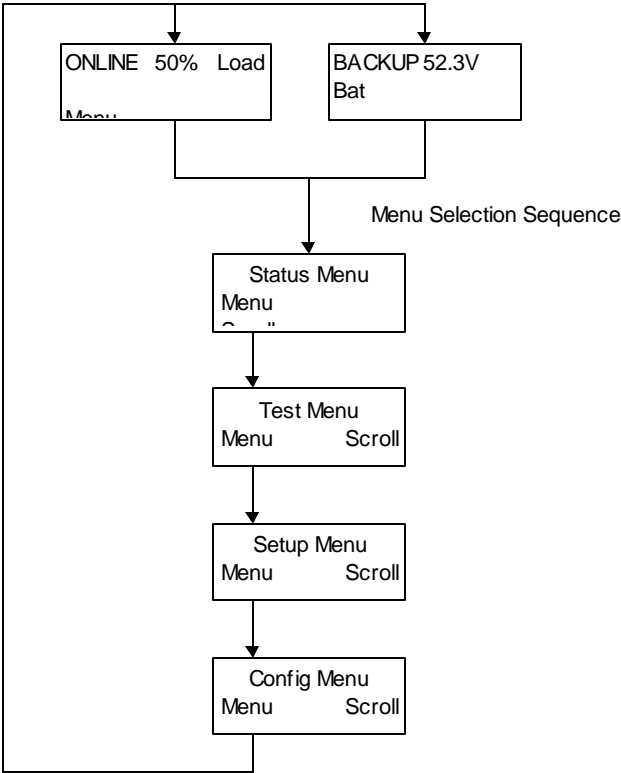

The Mode Display will be shown after the unit's first power up diagnostics have been run, or when it is selected by stepping through the menu selections.

### Status Menu

The status menu allows you to read the parameters of the UPS according to the flow chart shown below. The button under the word "Scroll" will step you to the next selection and the button under the word "Menu" will step you to the TEST menu.

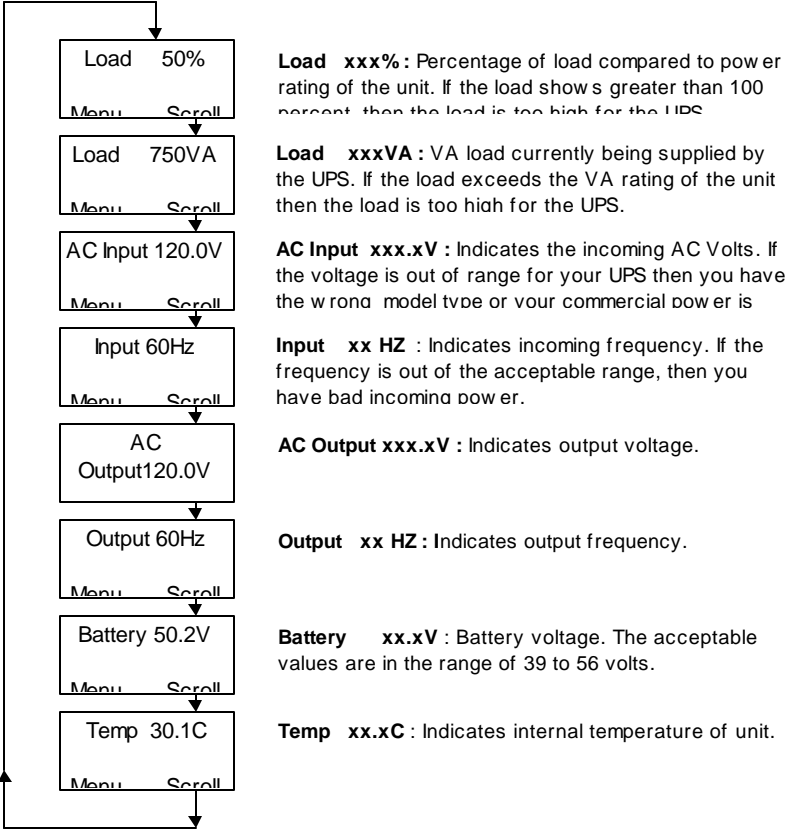

**NOTE:** If a power event is happening, the screen describing the event will appear.

## Test Menu

The Test menu allows you to select the user controlled test modes. The "Quick Test" mode will perform a test of all of the key parameters of the UPS, including operation from the battery. The "Test To Low Bat" selection will place the UPS in the battery power mode, and run until the battery voltage drops to the Low Battery Warning point.

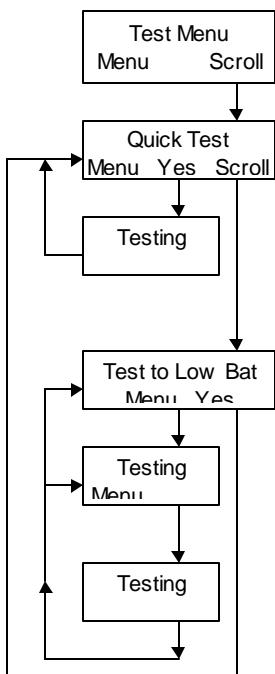

Select "scroll" to go to the various test choices.

Perform the 10 second Quick Test.

Perform extended "Test to Low Battery"

**Test to Low Battery** - Pressing the **YES** button will run the load on the inverter until battery voltage drops to the low voltage battery warning point, or until the test is canceled by the user.

The test may be canceled at any time by pressing the "Cancel" button. Pressing the "Menu" button will move you to the **SETUP** menu, even if the test is still in progress. By repeatedly pressing the "Menu" button, you can move to the **STATUS** menu to monitor the progress of the test. Stepping through the status menu with the "Scroll" button will allow you to read the various values described previously in the STATUS menu. To terminate the test, use the "Menu" button to select the TEST menu. You will then be given the option to cancel the test. If an alarm condition occurs you will be transferred to the reporting display to determine the cause of the alarm.

## Setup Menu

The Setup menu allows you to set some of the UPS operating parameters. The parameters that can be set include the following;

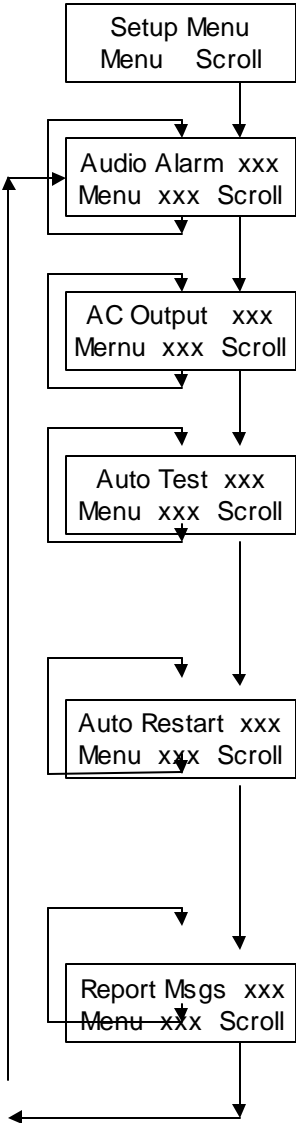

**Note:** At any step in the “Setup” menu, pressing the “MENU” selection will move you to the “Config” menu.

**Audio Alarm xxx :** Turn the Audible Alarm on or off. If the Alarm is OFF, the beeper will NOT sound during an alarm condition. The normal condition is ON.

**AC Output xxx :** Turn the AC output on or off. If the AC Output is turned OFF, no power will be supplied to your equipment. The normal condition is ON. Whenever the UPS power switch is turned on, this parameter is reset to ON.

**Auto Test xxx :** Turn the Auto-test mode on or off. If the Auto-test mode is OFF, periodic checks running under battery power will NOT be performed. If Auto-test is ON, then every 14 days the system will check the status of the system and run the power from the battery for about 10 seconds. The normal condition is ON.

**Auto Restart xxx :** Turn the Auto-restart on or off. If Auto-restart is ON, AND the UPS turned itself off because of a low battery condition, the UPS will automatically restart after AC power is restored to the unit. Otherwise, after a low battery shutdown condition has occurred, the UPS will not restart and the condition of the fault will be displayed. The normal condition is ON.

**Report Msgs xxx :** Turn the Report messages on or off. If the Report Msgs is turned ON, then the messages will be immediately displayed when a condition exists. If the Report Msgs is OFF then the messages will not be immediately displayed, but will be displayed when you cycle through the STATUS menu. The normal condition is turned ON.

## Config Menu

The configuration menu displays the configuration of the UPS. This information is required when you contact Minuteman's technical support. Pressing the "Menu" button will return to the "Mode Display" menu.

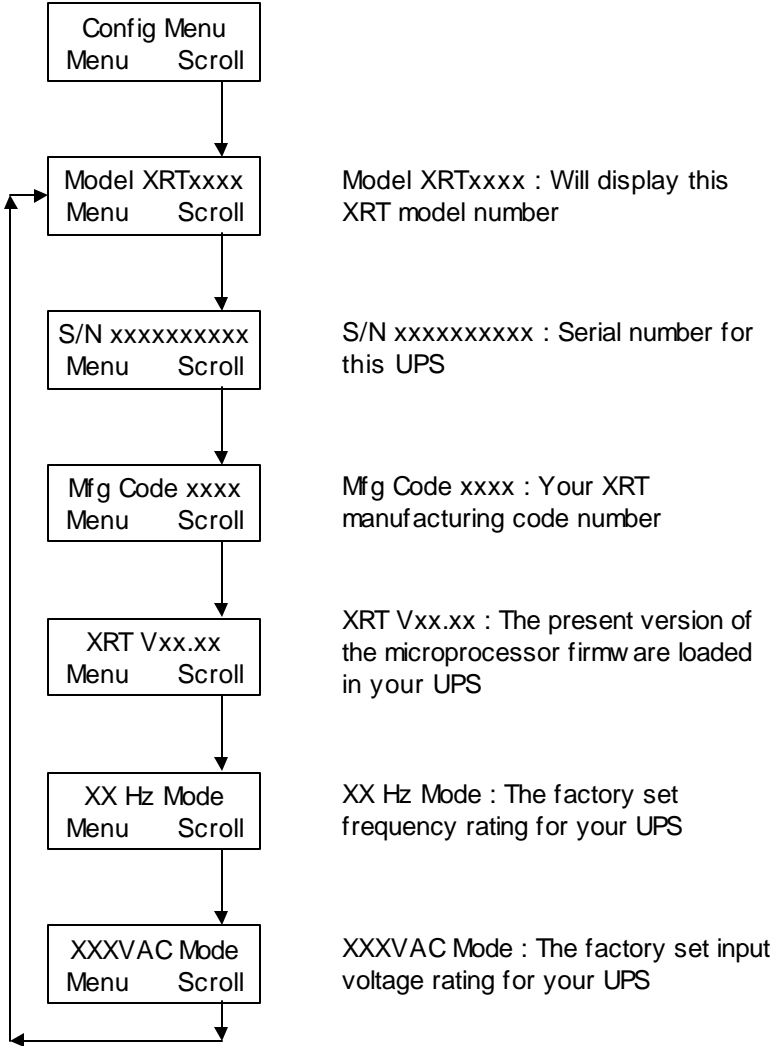



## ALARMS AND WARNINGS

### Alarms

Conditions that may require immediate attention will be signaled by the UPS beeping its audible alarm. The following is a list of alarms the XRT UPS reports:

#### On Battery (AC Fail)

When the UPS has detected a condition that forces it to run from the battery, an alarm will sound every 30 seconds. The alarm stops when normal AC returns to the unit. Pressing the Test/Alarm Silence button on the XRT600 will silence this alarm. However, a new alarm will sound if any of the other alarm conditions occur. In the XRT1000 and higher units, the audible alarm will be complemented by a display on the LCD screen indicating the exact nature of the alarm, and may be turned off by selecting the SETUP menu and turning the alarm off. Shutting off the audible alarm in this fashion does not affect the alarm reporting through the communications port or the LCD screen.

#### Overload

The UPS is overloaded when the supplied loads exceeds 110% of the rating shown in the **GENERAL PRODUCT SPECIFICATIONS** section of this manual. In an overload condition, the XRT600 will blink the top four LED's, and on the XRT1000 and above, the "Overload" message will be displayed. The audible alarm will sound every 1/2 second. If the fault is not cleared within 30 seconds, or if the overload exceeds 115% of the rating, the UPS will shut itself down.

#### Low Battery Warning

When the UPS is running on its batteries and the battery voltage drops to approximately 42 Volts, the Low Battery Warning will sound, beeping every 1/2 second. The Low Battery Warning light on the LED front panel will blink, and on the LCD front panel, the "Battery Low" message will be displayed. If the battery voltage drops to 39 volts, the UPS will shut itself down.

#### Check Fan

If the cooling fan fails, the Check Fan alarm will sound, beeping every 1/2 second. The UPS will shut itself down after 60 seconds.

## WARNING EVENTS

### Line Voltage Regulation

The UPS will warn you when the incoming utility power exceeds its normal limits. On the LED front panel the Voltage Regulator LED will light, indicating the incoming voltage is out of range. On the LCD front panel, you will see a “Low Voltage In” or “High Voltage In” message. In either case the audible alarm will not sound.

### Output Voltage Switching

The Output of the UPS may be turned OFF or ON by any of three ways other than the power switch. The XRT1000 and above output AC may be manually turned on or off by selecting the Output On or Off command in the SETUP menu. In all models the output may be turned on or off via the RS-232 Serial port or by using the user supplied Output Power Off switch. The XRT1000 and above units will notify you by the “OUT OFF Ext CNTL” screen if the output was turned off from the RS-232 command, or “OUT OFF Man CNTL” screen if the output was turned off from the Output Power Off switch (see the **SETUP** menu section). The XRT600 does not have this reporting feature, but if no power is being supplied from the UPS and the AC Power LED is lit, then the probable reason is that the output has been turned off.

## OPTIONS

The options available for the XRT series UPS' s are in three categories.

### Battery Packs

Multiple XRTBP1 and XRTBP3 battery packs may be ordered to configure your system for various loads and battery runtimes. A short table of loads and battery packs for the expected run times are shown in the **GENERAL PRODUCT SPECIFICATIONS** section.

### Software

Complete power management software is available from Minuteman as an option.

### Back-panel Receptacles

Standard back-panel receptacle configurations for the various XRT models are shown in the **GENERAL PRODUCT SPECIFICATIONS** section of this manual. Special configurations can be ordered directly from Minuteman.

## 5. SYSTEM BATTERIES

The batteries used in the XRT series of UPS' s and the XRTBP battery packs are sealed, maintenance-free, lead-acid batteries, with the electrolyte completely absorbed in the plates and separator material. For maximum battery life, battery temperature should be kept as cool as practical indoors. Expected average battery life is 5 years. The XRT units monitor the condition of the batteries and indicate when the batteries are low. If, after charging for an appropriate time, (according to the number of battery packs on the system) and the batteries are still low, this indicates the batteries should be replaced. Replacement batteries and battery packs are available from Minuteman or your local distributor or dealer.

When batteries are replaced, dispose of the batteries according to local regulations or return the batteries to your dealer or distributor for proper disposal. If you cannot dispose of the old batteries, they may be returned to Minuteman for proper disposal. Call Minuteman Technical Support for instructions on returning the batteries.

**NOTE: Only the XRTBP battery packs are to be used with the XRT units. The XRT UPS has the DC battery negative terminal tied to the AC ground at the remote communications port. Other battery systems may have the DC battery positive terminal tied to AC ground. This would result in a direct short and may damage the unit and void your warranty.**

## STORAGE INSTRUCTIONS

If the UPS is to be stored, allow the batteries to fully charge for 24 hours, then store the unit in a cool, dry location. For extended storage in moderate climates, the batteries should be charged for 8 hours every 3 months. Repeat this operation every 2 months in high temperature locations.

## BATTERY REPLACEMENT

It is recommended that you turn the UPS off and disconnect the input power cord from the receptacles prior to connecting or disconnecting the battery terminals. Only UPS' s that have external battery packs can be changed "HOT", that is with AC power connected to the unit, and while supplying power to your equipment. If battery packs MUST be changed while power is on, they can ONLY be changed while the AC line is supplying power to the protected equipment. Be extremely careful while plugging or unplugging additional battery packs. Insure that the cable connectors have the Red and Black terminals aligned before plugging together. Improper alignment may result in a short circuit that can destroy the battery packs and the UPS, as well as causing a fire and injury hazard. If the units must be opened to replace the batteries, the following precautions should be followed;

1. Disconnect all receptacles, line cords and battery connectors BEFORE removing the case screws.
2. Remove watches, rings, and other metallic jewelry before servicing the batteries.
3. Use tools with insulated handles.
4. Wear protective gloves and eye-wear.
5. Do not lay tools or other objects on top of the batteries.
6. Insure all connections to the new batteries are EXACTLY the same as they were from the old batteries. It is recommended that you make yourself a sketch of the batteries and their connections BEFORE you attempt to remove the old batteries.
7. Verify all of the battery brackets and mechanical fittings are replaced exactly as they were removed.

## 6. TROUBLESHOOTING

If your XRT UPS does not function as you expect or if you get an error code or message, please follow the chart outlined below before calling your dealer or Minuteman. Make note of each problem so that we may quickly troubleshoot and correct the problem. Please remember to have your model and serial number before calling.

<b>TROUBLESHOOTING</b>		
<b>SYMPTOM</b>	<b>POSSIBLE CAUSE</b>	<b>ACTION TO TAKE</b>
No lights/menu, no alarm (UPS not ON)	Front panel switch in off position. Rear panel circuit breaker tripped. No incoming utility.	Turn on switch. Reset circuit breaker. Check utility input power.
Low AC is indicated, and UPS is not supplying power	Incoming AC is < 75% of nominal and >72% of nominal	On LED front panel, press TEST/ALARM SILENCE switch. On LCD front panel, press any button to go to the battery mode.
No output, some LED's are on, or the LCD shows error message.	This is an error code, and there are many different causes.	Look up the message or error code, and take the appropriate action and/or call for service.
Backup time is less than the rating	Battery not fully charged. 1 or more dead batteries. Load is greater than estimated. Charger failure.	Recharge batteries for at least 8 hours. If problem persists, call for service. Verify load is correct.
The UPS appears to be working, but has no output voltage	Output turned off by computer or external control.	Select STATUS menu, and search for OUTPUT OFF message. Turn on with SETUP menu or cycle Power Switch. Verify remote OFF contact / switch is off.
UPS beeps continuously	Imminent shutdown pending. Error code will be displayed.	Look up the message or error code, and take the appropriate action and/or call for service.

## INITIAL ERROR MESSAGES

As soon as the UPS is first turned on, it performs a series of self tests. If the self tests fail then the UPS will report the failure and display the fault. If the self test passes, but the UPS was shut down previously due to a fault, the previous fault code or message will be displayed. This feature allows you to determine why the UPS shut down. The LCD screen will display the words "Error Detected" on the top line of the screen, and one of the messages in the Error Code list is shown on the second line.

### Model XRT600 LED Display Error Codes Displayed in binary code

LED DISPLAY	POSSIBLE CAUSE	ACTION TO TAKE
000x	Low ac input	Verify incoming ac
00x0	Input ac to high	Verify incoming ac
00xx	Input AC frequency out of range for unit.	Verify incoming freq. for this model.
0x00	Excessive output current being drawn	Verify output load matches unit.
0x0x	Fan not running	Verify nothing has gotten into the fan
0xx0	Fan or air passages blocked	Clear air passages
0xxx	Battery pack is bad or disconnected	Check battery voltage and connections
x000	UPS has had a hardware fault	Call for service
x00x	Output voltage is too high	Call for service
x0x0	Output voltage is too low	Call for service

On the XRT600, these messages can be cleared by pressing the Test/Alarm Silence button.

The LCD reporting screen in the XRT1000 and above UPS' s allow s much more flexibility in communicating faults to you, and therefore has two classes of fault messages. The first occurs when the unit is initially turned on as explained above, and the second is if a fault is detected during normal operation or testing.

**Model XRT1000 and above error messages**

LCD DISPLAY	POSSIBLE CAUSE	ACTION TO TAKE
Input AC Low	Low AC input	Verify Incoming AC
Input AC High	Input AC is too high	Verify Incoming AC
Input Frequency Bad	Input AC frequency out of range for unit.	Verify incoming freq. for this model.
Over current	Excessive output current being drawn	Verify output load matches unit.
Check fan	Fan not running	Verify nothing has gotten into fan.
Over temp	Fan or air passages blocked	Clear air passages.
Battery Bad	Battery pack is bad or disconnected	Check battery voltage and connections.
Hardware fault	UPS has had a hardware fault	Call for service
Output AC high	Output voltage is too high	Call for service
Output AC low	Output voltage is too low	Call for service

The Initial Error Message can be cleared by pressing any button. If the fault is cleared, then the fault existed from a prior shutdown. If the fault is not cleared then the fault presently exists. If the previous fault was due to a low battery condition and the AC line returns to normal, the UPS will automatically re-supply power to your equipment. In the XRT1000 and above units, you may prevent the automatic return to power by setting the Auto Restart to OFF in the Setup menu described earlier.

# OPERATING FAULTS

If, during operation, a fault is detected the XRT UPS will sound the alarm beeper and display the fault cause on the front panel. If you have disabled the alarm beeper, the fault will still be displayed. In the XRT600 UPS the upper four LED's will be turned on according to the chart provided earlier. In the XRT1000 and above, the LCD screen will show the fault message. If more than one fault happens simultaneously, all active faults will be shown for 3 seconds and then cycled to the next fault. Following is a list of alarm faults for the XRT1000 and above, and their meaning;

Overload XXX%

**Overload xxx%** The load has exceeded 110% of the capability of the UPS. If between 110-114%, overload screen is displayed, alternating between "To Continue Press Any Key". Pressing any key returns you to the Mode Display and the unit proceeds with shutdown after 30 seconds.

Error Detected  
Over Current XXX%

**Over Current xxx%** The load has exceeded 115%, alarm sounds and the unit shuts down.

Error Detected  
Battery Low

**Battery Low** The battery voltage has fallen below 42 Volts.

Error Detected  
Over Temp XX.XC

**Over Temp xx.xC** The inverter temperature is too high.

Low Voltage In

**Low Voltage In** The utility power is below safe operating range. The UPS is correcting this condition without using batteries. This screen alternates messages between "Low Voltage In" and "To Continue Press Any Key". Pressing any key will return you to the Mode Display Screen.

High Voltage In

**High Voltage In** The utility power is above safe operating range. The UPS is correcting this condition without using batteries. This screen alternates messages between "High Voltage In" and "To Continue Press Any Key". Pressing any key will return you to the Mode Display Screen.

OUT OFF Ext Cntl  
Output OFF

**OUT OFF Ext CNTL** The output of the UPS has been turned off via the remote control port. This screen alternates with the "To Continue Press Any Key". Pressing any key returns you to the Mode Display screen.

OUT OFF Man Cntl  
Output OFF

**OUT OFF Man CNTL** The output of the UPS has been turned off via the Output Off relay/switch input. This screen alternates with the "To Continue Press Any Key". Pressing any key returns you to the Mode Display screen.



## **SELF TEST**

To have the XRT600 UPS perform a 10 second self test, press the Test/Alarm Silence key. This will perform the self test and report any errors to the LED display. A successful self test is indicated by the normal AC LED being lit.

For the XRT1000 and above units, select the TEST MENU on the LCD screen and then select the QUICK TEST. The screen will report "TESTING" until the completion of the self test. If the unit is OK the screen will return to the Quick Test menu, otherwise the error will be reported as previously described.

When all faults are cleared, the LCD front panel screen returns to Mode Display. Pressing the MENU button will transfer you to the STATUS MENU described previously. In the LED front panel version the error code will be cleared and the normal conditions will be displayed.

## 7. OBTAINING SERVICE

If the UPS requires service:

1. Use the **TROUBLESHOOTING** section 6 to eliminate obvious causes.
2. Verify that no circuit breakers are tripped. A tripped circuit breaker is the most common problem.
3. Go to section 6 and perform the self test to identify any reported errors.
4. Call your dealer for assistance. If you cannot reach your dealer, or if he cannot resolve the problem, call or FAX Minuteman technical support at the following numbers:

Voice phone (972) 446-7363, FAX line (972) 446-9011.

e-mail: support@minuteman-ups.com

Please have the following information available **BEFORE** calling technical support.

- A. Your Name and address.
  - B. Where and when the unit was purchased.
  - C. All of the model information on the rear of your unit.
  - D. Any information on the failure, INCLUDING Error Codes or Error Messages shown on the front panel.
  - E. A description of the protected equipment, including model numbers if possible.
  - F. A technician will ask you for the above information and if possible, help solve your problem over the phone. In the event that the unit requires factory service, the technician will issue you a Return Material Authorization number (RMA#).
  - G. If the UPS is under warranty, the repairs will be completed at no charge. If not, there will be a charge for repair.
5. Pack the UPS in its original packaging. If the original packaging is no longer available, ask the technical support technician about obtaining a new set.
    - A. It is important to pack the UPS properly in order to avoid damage in transit. Never use Styrofoam beads for a packing material.
    - B. Include a letter with your name, address, daytime phone number, RMA number, a copy of your original sales receipt, and a brief description of the trouble.

**6. Mark the RMA # on the outside of all packages. The factory**

**cannot accept any package without the RMA # marked on the outside of the shipping box.**

7. Return the UPS by insured, prepaid carrier to:  
Minuteman, Para Systems Inc.  
1455 LeMay Drive  
Carrollton, Tx. 75007

# 7. GENERAL PRODUCT SPECIFICATIONS

	XRT600 (XRT600/2)	XRT1000 (XRT1000/2)	XRT1500	XRT2000 (XRT2000/2)	XRT2001	XRT2002
Acceptable input volts	92-140v (169-268v)	92-140v (169-268v)	92-140v N/A	92-140v (169-268v)	176-278v	152v-267v
Output Voltage (on-line) +/- 10%	120v (230v)	120v (230v)	120v N/A	120v (230v)	120v/240v	120/208v
Nominal input frequency	60 Hz (50 Hz)	60 Hz (50 Hz)	60 Hz N/A	60 Hz 50 Hz	60 Hz	60 Hz
Input protection	Reset-able circuit breaker					
Frequency limits (online)	60 Hz. +/- 3 Hz (50 Hz. +/- 3 Hz.)					
Transfer time	4 ms Typical					
Max load (VA/watts)	600 / 600	1000 / 1000	1500 / 1500	2000 / 2000	2000 / 2000	2000 / 2000
On Battery Output Voltage	120v (230v)	120v (230v)	120v (N/A)	120v (230v)	120v / 240v	120v / 208v
On Battery frequency	60 Hz +/-0.1 Hz. Unless synchronized to utility during brownout. (50 Hz +/- 0.1 Hz. Unless synchronized to utility during brownout)					
On Battery waveform	Low distortion sine wave					
Protection	Over-current and short circuit protected: latching shutdown on overload					
Surge energy rating	480 joules: one time 10 to 1000ms waveform ( 120 VAC units )					
Surge current capability	6500A maximum: one time 8 to 20 ms waveform (120 VAC units )					
Surge response time	0 Ns (instantaneous) normal mode, <5 Ns common mode					
Surge volts let thru	< .2%					
Noise filter	Normal and common mode EMI /RFI suppression, 100 kHz to 10 MHz					
Battery type	Spill proof, sealed, maintenance free, lead-acid					
Typical battery life	5 years					
Typical recharge time	4 hours for a single battery pack					
Operating temp	0 to 40° C (+32 to 104° F)					
Operating & storage relative humidity	0 to 95% non-condensing					
Storage temperature	-15 to +45° C (+5 to 113° F)					
Operating elevation	0 to 3000 meters ( 0 to 10,000 ft. )					
Electromagnetic immunity	IEC 801-2, 801-3, 801-4: Severity level 5					
Audible noise	<45 dB @ 1 meter					
Audible Alarm	On overload, On battery, Low battery warning, check fan					
Communication s port	DB-9 Minuteman standard					

<b>Size (H X W X D)</b>	<b>10 x 8.75 x 19.75 in. (25.4 x 22.2 x 50.2 cm.)</b>			
<b>Weight net</b>	<b>59 lb. (26.82 kg.)</b>	<b>50 lb. (22.73 kg.)</b>	<b>72 lb. (32.73 kg.)</b>	<b>74 lb. (33.64 kg.)</b>
<b>Battery packs</b>	<b>XRTBP1 (48 VDC 17 AH)</b>			<b>XRTBP3 (48 VDC 90 AH)</b>
<b>BP SIZE (H X W X D)</b>	<b>10 x 8.75 x 19.75 in. (25.4 x 22.2 x 50.2 cm.)</b>			<b>15.5 x 15.0 x 25.0 in. (39.4 x 38.1 x 63.5 cm.)</b>
<b>Weight net</b>	<b>66 lb. ( 30 kg. )</b>			<b>271 lb. (123 kg.)</b>
<b>Safety approvals</b>	<b>ETL (UL 1778) CETL (CSA C22.2) U.S. versions only</b>			
<b>EMC verification</b>	<b>FCC CLASS A U.S. versions only</b>			

**Note:** For input voltages in ranges shown above or below the nominal input voltage, the voltage regulator will produce the nominal output voltage without draining the batteries.

In the Line-Interactive mode, the output is held to the nominal voltage +/- 10%. In the On-Battery mode, the output is the nominal voltage +/- 3%.

The XRT600 contains an internal battery pack plus “daisy chain” capability with the XRTBP1 and XRTBP3 external battery packs. Battery packs may be daisy chained for extra capacity on all models.

# REMOTE COMMUNICATIONS

Remote communications and control may be implemented via the DB-9 communications port. This interface is compatible with the Minuteman Sentry or PowerMon software. The connector interface is shown below ;

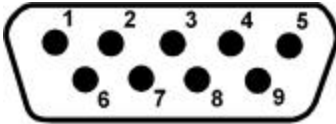

Pin	Function
1	Unused
2	Transmitted Serial Data from UPS
3	Received Serial Data to UPS
4	AC Fail from UPS (simulated Normally Open relay contact)
5	Ground
6	Low Battery Warning from UPS (simulated Normally Open relay contact)
7	AC Fail from UPS (simulated Normally closed relay contact)
8	AC fail from UPS (High = AC Fail)
9	Remote Shutdown Output to UPS

# REMOTE DIRECT COMMUNICATIONS

Pin 1:	Not Used
Pin 2: LBW	Output signal from UPS (RS232 levels) High signal (+3 to +12 volts)= Low Battery Warning
Pin 3: UPS Shutdown	Input signal to UPS, Shutdown UPS (RS232 levels) High signal (+3 to +12 volts) = UPS OFF
Pin 4: AC Fail NO.	Output signal from UPS, open collector, High impedance = AC OK Low impedance to ground = AC Failed
Pin 5: Ground	Common Return
Pin 6: Low Battery Warning	Output signal from UPS, open collector High impedance = OK Low impedance to ground = Low Battery Warning
Pin 7: AC Fail NC	Output signal from UPS, open collector High impedance = AC Failed Low impedance to ground = AC OK
Pin 8: AC Fail Logic Signal	Output signal from UPS, logic level Logic High (+3 to +12 volts) = AC failed Logic Low (0 volts) = AC OK
Pin 9: Remote Shutdown	Input signal to UPS, pulled to 5 VDC through 10 K ohms >2.4 VDC = Normal output <0.8 VDC = Output off

# BATTERY PACK AND RUNTIME SPECIFICATIONS

APPROXIMATE RUNTIMES IN HOURS  
 RUNTIMES MAY VARY BASED ON ACTUAL  
 LOAD AND AGE OF BATTERIES

<b>XRT600</b>						
LOAD VA	INT. BAT	PLUS ONE XRTBP1	PLUS TWO XRTBP1	PLUS THREE XRTBP1	PLUS ONE XRTBP3	PLUS TWO XRTBP3
50	10.2	35.0	59.0	72	72	72
75	5.9	20.4	42.2	64.2	72	72
100	4.6	15.7	32.7	46.3	68.4	72
150	2.8	9.6	20.6	29.2	43.6	72
200	1.9	6.8	14.9	21.0	31.3	65.9
250	1.5	5.2	11.7	16.5	24.3	51.6
300	1.2	4.2	9.5	13.5	19.8	42.0
350	1.0	3.5	8.0	11.4	16.7	35.2
400	.8	2.9	6.9	9.8	14.5	30.2
450	.5	2.5	6.1	8.6	12.7	26.4
500	.6	2.2	5.4	7.7	11.3	23.4
550	.5	2.0	4.9	6.9	10.2	21.0
600	.5	1.8	4.4	6.2	9.3	19.1



**APPROXIMATE RUNTIMES IN HOURS**  
**RUNTIMES MAY VARY BASED ON ACTUAL**  
**LOAD AND AGE OF BATTERIES**

	LOAD VA	ONE XRTBP1	TWO XRTBP1	THREE XRTBP1	ONE XRTBP3	TWO XRTBP3
XRT1000, XRT1500, XRT2000	50	24.8	53.6	72	72	72
XRT1000, XRT1500, XRT2000	75	14.4	31.3	52.5	72	72
XRT1000, XRT1500, XRT2000	100	11.1	24.4	40.7	63.4	72
XRT1000, XRT1500, XRT2000	150	6.8	15.5	25.6	40.5	72
XRT1000, XRT1500, XRT2000	200	4.8	11.3	18.5	29.1	63.4
XRT1000, XRT1500, XRT2000	250	3.6	8.8	14.5	22.5	49.7
XRT1000, XRT1500, XRT2000	300	2.9	7.2	11.9	18.4	40.5
XRT1000, XRT1500, XRT2000	350	2.4	6.1	10.0	15.5	33.9
XRT1000, XRT1500, XRT2000	400	2.1	5.2	8.6	13.4	29.1
XRT1000, XRT1500, XRT2000	450	1.8	4.5	7.6	11.8	25.4
XRT1000, XRT1500, XRT2000	500	1.6	3.9	6.7	10.5	22.5
XRT1000, XRT1500, XRT2000	550	1.4	3.5	6.0	9.5	20.2
XRT1000, XRT1500, XRT2000	600	1.2	3.1	5.4	8.6	18.4
XRT1000, XRT1500, XRT2000	700	1.0	2.5	4.5	7.2	15.5
XRT1000, XRT1500, XRT2000	800	.8	2.1	3.8	6.2	13.4
XRT1000, XRT1500, XRT2000	900	.7	1.8	3.3	5.4	11.8
XRT1000, XRT1500, XRT2000	1000	.6	1.6	2.9	4.8	10.5
XRT1500, XRT2000	1100	.5	1.4	2.5	4.2	9.5
XRT1500, XRT2000	1200	.5	1.2	2.2	3.8	8.6
XRT1500, XRT2000	1300	.4	1.1	2.0	3.4	7.9
XRT1500, XRT2000	1400	.4	1.0	1.8	3.1	7.2
XRT1500, XRT2000	1500	.3	.9	1.7	2.9	6.7
XRT2000	1600	.3	.8	1.5	2.6	6.2

XRT2000	1700	.2	.8	1.4	2.4	5.8
XRT2000	1800	.2	.7	1.3	2.2	5.4
XRT2000	1900	.2	.6	1.2	2.1	5.1
XRT2000	2000	.2	.6	1.1	2.0	4.8

## 8. LIMITED PRODUCT WARRANTY

Para Systems Inc. (Para Systems) warrants this equipment, when properly applied and operated within specified conditions, against faulty materials or workmanship for a period of two years from the date of original purchase by the end user. For equipment sites within the United States and Canada, this warranty covers repair or replacement of defective equipment at the discretion of Para Systems. Repair will be from the nearest authorized service center. Replacement parts and warranty labor will be borne by Para Systems. For equipment located outside of the United States and Canada, Para Systems only covers faulty parts. Para Systems products repaired or replaced pursuant to this warranty shall be warranted for the Un-expired portion of the warranty applying to the original product. This warranty applies only to the original purchaser who must have properly registered the product within 10 days of purchase.

The warranty shall be void if (a) the equipment is damaged by the customer, is improperly used, is subjected to an adverse operating environment, or is operated outside the limits of its electrical specifications; (b) the equipment is repaired or modified by anyone other than Para Systems or Para Systems-approved personnel; or (c) has been used in a manner contrary to the product's operating manual or other written instructions.

Any technical advice furnished before or after delivery in regard to use or application of Para System's equipment is furnished without charge and on the basis that it represents Para System's best judgment under the circumstances, but it is used at the recipient's sole risk.

EXCEPT AS PROVIDED HEREIN, PARA SYSTEMS MAKES NO WARRANTIES, EXPRESSED OR IMPLIED, INCLUDING WARRANTIES OF MERCHANTABILITY AND FITNESS FOR A PARTICULAR PURPOSE. Some states do not permit limitation of implied warranties; therefore, the aforesaid limitation(s) may not apply to the purchaser.

EXCEPT AS PROVIDED ABOVE, IN NO EVENT WILL Para Systems BE LIABLE FOR DIRECT, INDIRECT, SPECIAL, INCIDENTAL, OR CONSEQUENTIAL DAMAGES ARISING OUT OF THE USE OF THIS PRODUCT, EVEN IF ADVISED OF THE POSSIBILITY OF SUCH DAMAGE. Specifically, Para Systems is not liable for any costs, such as lost profits or revenue, loss of equipment, loss of use of equipment, loss of software, loss of data,

cost of substitutes, claims by third parties, or otherwise. The sole and exclusive remedy for breach of any warranty, expressed or implied, concerning Para System's products and the only obligation of Para Systems hereunder, shall be the repair or replacement of defective equipment, components, or parts; or, at Para System's option, refund of the purchase price or substitution with an equivalent replacement product. This warranty gives you specific legal rights and you may also have other rights which vary from state to state.

Longer term and F.O.B. job site warranties are available at extra cost. Contact Para Systems (1-972-446-7363) for details.

## Free Manuals Download Website

<http://myh66.com>

<http://usermanuals.us>

<http://www.somanuals.com>

<http://www.4manuals.cc>

<http://www.manual-lib.com>

<http://www.404manual.com>

<http://www.luxmanual.com>

<http://aubethermostatmanual.com>

Golf course search by state

<http://golfingnear.com>

Email search by domain

<http://emailbydomain.com>

Auto manuals search

<http://auto.somanuals.com>

TV manuals search

<http://tv.somanuals.com>